

VG710 Onboard Gateway

Quick Start Guide

1. Packing List

Standard packing list:

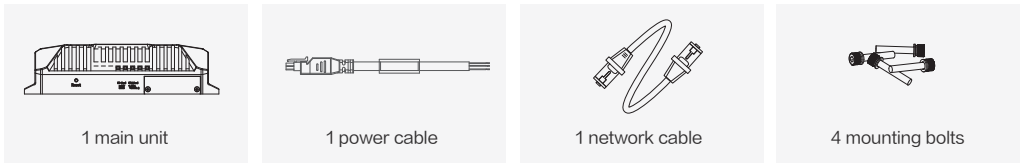

Optional accessories:

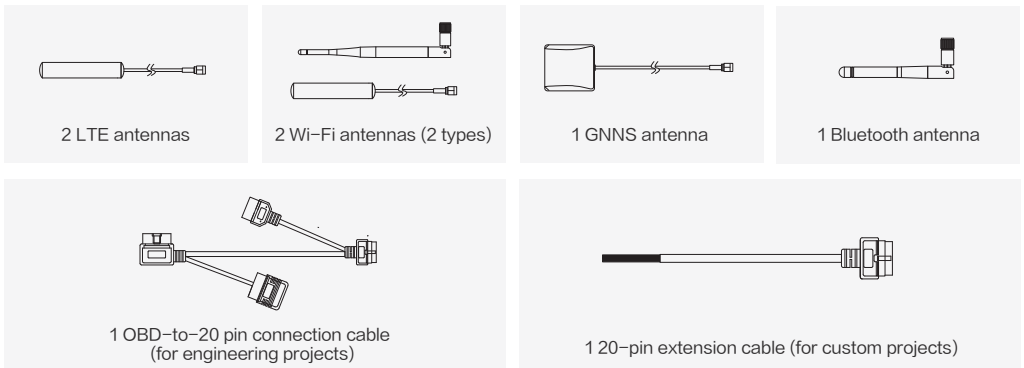

2. Adapted Vehicle Models

- Dongfeng Tianlong
- Dongfeng Tianjin
- Sinotruck HAOWO
- BAIC Motor Foton
- BAIC Motor Auman (BJ4259SNHKB-AA)
- Iveco (NJ6725DC)
- Iveco (NJ6605DC)
- Iveco (NJ1045EFCS)
- Iveco (NJ6605DC)
- Yutong Heavy Industries

3. Appearance

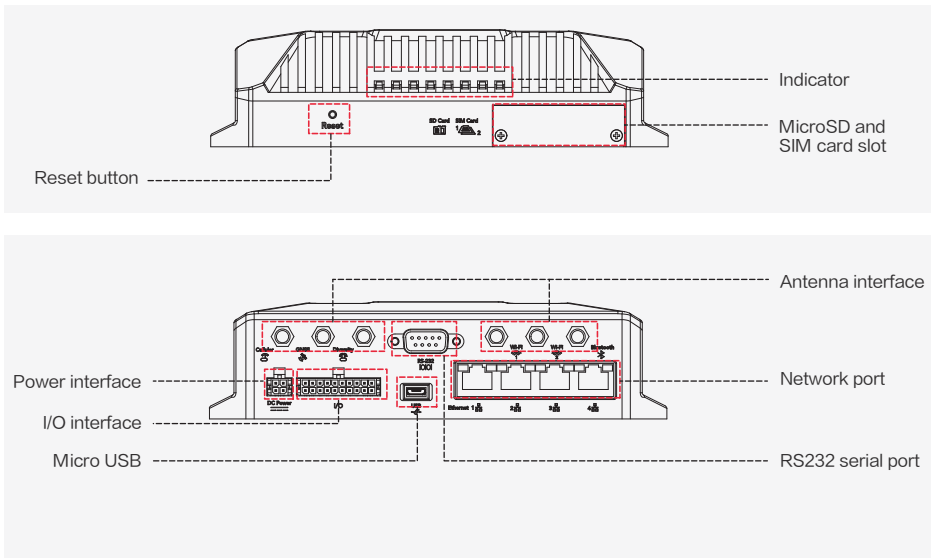

4. Installation and Wiring

In common scenarios, install the SIM card, dial-up antenna, GNSS antenna, and Wi-Fi antenna on the device, connect to the I/O interface, and then connect to the power supply.

(1) Installing the SIM card and microSD card

Install the SIM card for Internet access through dial-up. The device automatically performs dial-up after power-on.

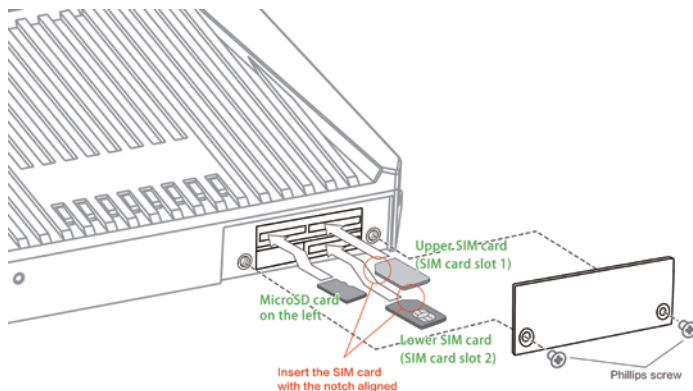

(2) Installing the antennas

Note:

During installation, ensure that the dial-up antenna, GNSS antenna, Wi-Fi antenna, and Bluetooth antenna have one-to-one mapping with the antenna interfaces.

When the device performs dial-up, Cellular indicates the primary dial-up antenna, and Diversity indicates the secondary dial-up antenna. When signals are strong, you only need to install the primary antenna.

When signals are weak, install the primary and secondary antennas.

Installation steps:

1. Make ready the antennas and identify the antenna interfaces.
2. Fasten the antennas in the clockwise direction. Installation of the GNSS antenna is used as an example. The installation procedures for the other antennas are the same.

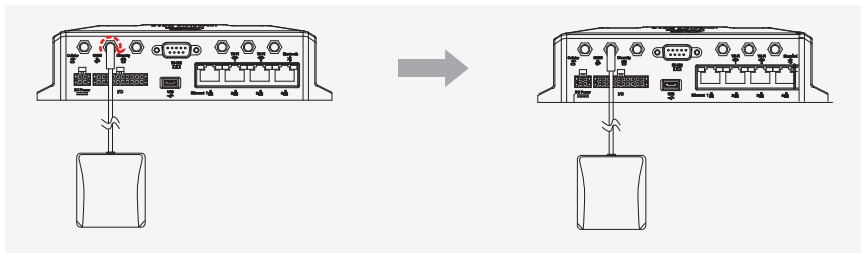

(3) Pins of the RS232 serial port

Currently, InHand Networks does not define the application scenarios of the RS232 serial port. You can connect to this port as needed.

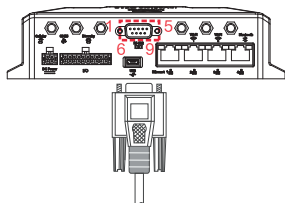

DB-9 interface definition

PIN	Definition	PIN	Definition	PIN	Definition
1	GND	4	RXD	7	CTS
2	DTR	5	DCD	8	RTS
3	TXD	6	RI	9	DSR

(4) I/O interface

The I/O interface is connected to the vehicle diagnosis interface to retrieve the vehicle status data.

Industrial terminals (20 pins)

PIN	Terminal Name	PIN	Terminal Name	PIN	Terminal Name
1	485-	8	AI4/DI4	15	DO1
2	CANL	9	AI2/DI2	16	GND
3	1-Wire	10	GND	17	AI5/DI5/WHEEL TICK
4	DO4	11	485+	18	AI3/DI3
5	DO2	12	CANH	19	AI1/DI1
6	GND	13	GND	20	GND
7	AI6/DI6/FWD	14	DO3		

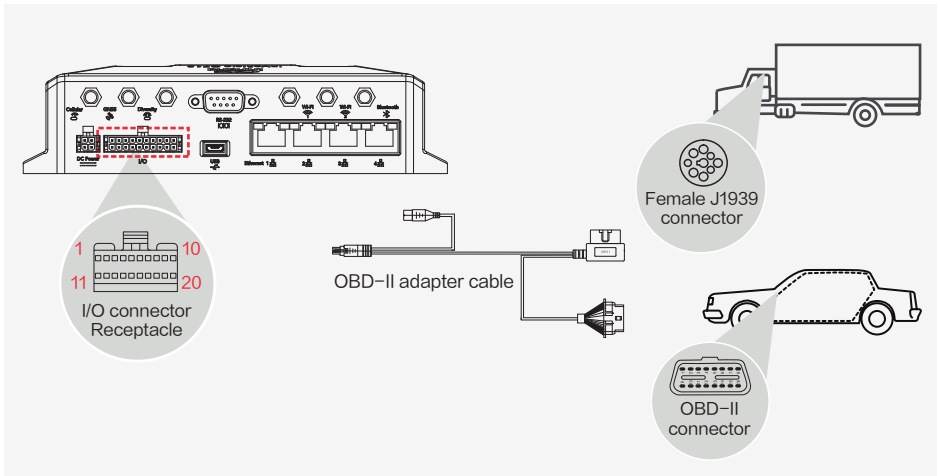

(5) Connecting to the power supply

In a normal engineering environment, connect to the power supply V+, GND, and ignition sense cable. Connect the ignition sense signal cable to the ignition sense cable, as shown in Figure 1. Connect the ignition sense cable and the anode in parallel in the test state, as shown in Figure 2.

Note: The device cannot be started if the ignition sense cable is not connected.

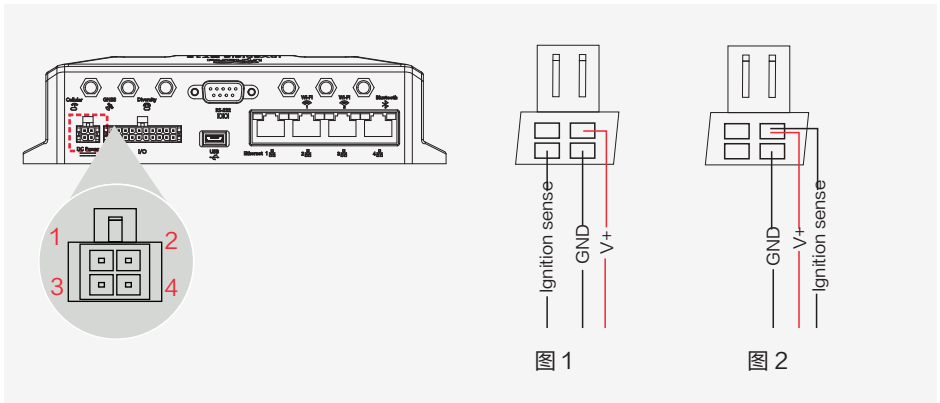

Power input range: 9–36 V DC;

recommended power: 18 W

Ways to obtain power:

- (1) Vehicle battery
- (2) Storage battery
- (3) Lighter
- (4) Power adapter (used indoors)

Power interface

PIN	Definition	Color	PIN	Definition	Color
1	NC		2	V+	Red
3	Ignition sense	White	4	GND	Black

(6) Connecting the network cable

Connect the network cable between the device and terminal.

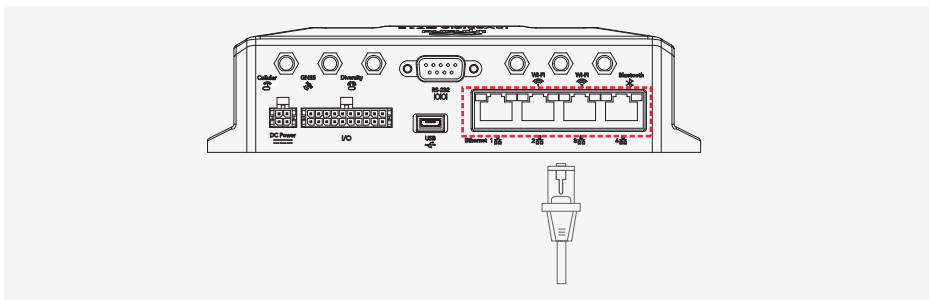

(7) USB interface

Currently, InHand Networks does not define the application scenarios of the USB interface.

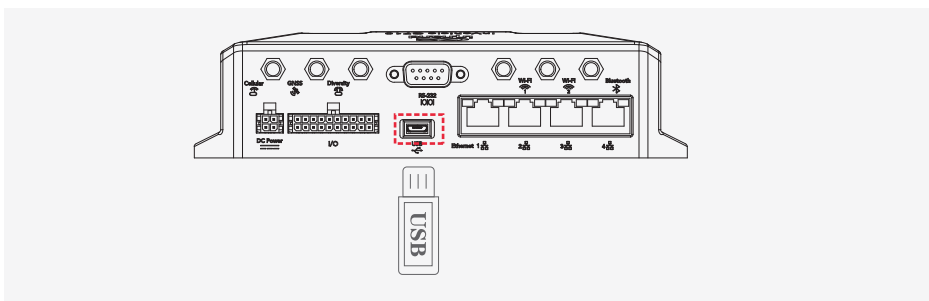

5. Status Confirmation

(1) Logging into the device web interface

Step 1: Connect to the device through the network cable or Wi-Fi (see the SSID and key on the nameplate).

If you use Wi-Fi, the Wi-Fi indicator is steady on in green or blinks.

Step 2: Enter the default device IP address 192.168.2.1 in the address bar of the web browser to open the login page.

Step 3: Enter the default username adm and password 123456 to go to the web interface.

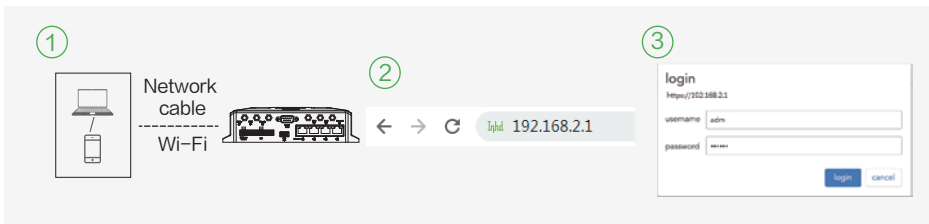

(2) Verifying the dial-up, GNSS, and OBD functions

Dial-up: After the dial-up function is enabled on the Network > Cellular page, Connected and the allocated IP address are displayed in the status bar. In this case, the device is successfully connected to the Internet, and the Cellular indicator is steady on in green, as shown in Figure 1.

GNSS: After the GPS function is enabled on the Services > GPS page, the gateway location is displayed in the status bar, indicating that the GPS function is normal, as shown in Figure 2.

OBD: The OBD function is normal if Connected is displayed on the Services > OBD page and data is uploaded, as shown in Figure 3.

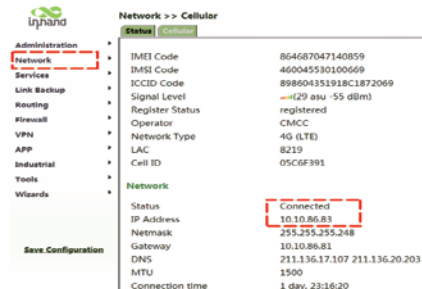

Figure 1

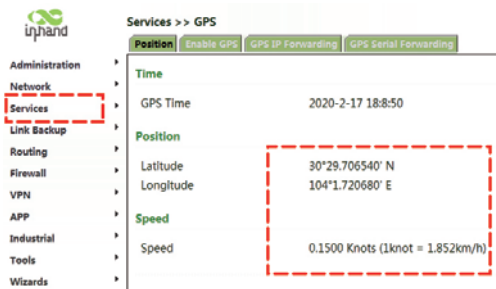

Figure 2

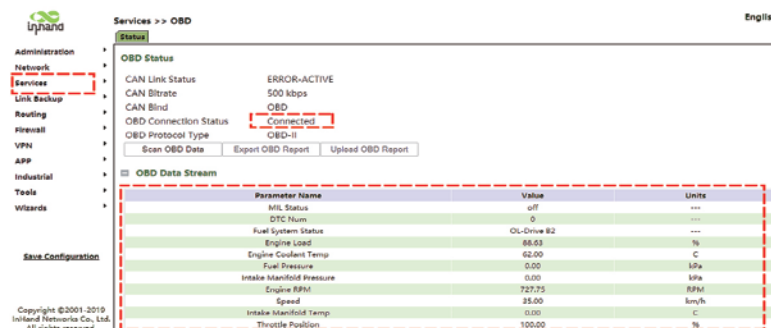

Figure 3

6. Default Setting Restoration

You can press the Reset button to restore default settings as follows.

Step 1: Power on the device and press the Reset button at the same time. About 15 seconds later, only the System LED indicator is turned on in red.

Step 2: Release the Reset button when the System LED indicator is turned off and then turned on in red.

Step 3: Press and hold the Reset button for 1 second when the System LED indicator is turned on. Then, release the Reset button.

After step 3, the System LED indicator blinks for 2 to 3 seconds and then turns off. In this case, the device is successfully restored to default settings.

