

Summer

everything you need

garbage cans . graffiti remover
hoses . lawn/garden . icemelt
heated jackets . security lighting . gloves
rakes . safety equipment . tools . shovels
matting . glass cleaner . garbage bags
mailboxes . wheelbarrow . sprinklers
shovels . commercial laundry . shop vacs
carpet cleaners . professional cleaners . and more

AMRE ANSWER GUIDE

Building Maintenance Parts and Supplies

2018-2019 CATALOGUE



*exclusive
full year
guide!*

www.amresupply.com 1.800.661.9891

Don't forget: Login online for wholesale pricing!

appliance parts . plumbing . sink repair parts . lighting fixtures
bulbs . mops . brooms . vacuums . cleaning chemicals . floor care
odour care . paper products . bathroom fans . air conditioning
floor fans . extinguishers . safety . tools . garburators
door security . door hardware . pulls . LED . door knobs
baseboard heaters . hot water tank . fittings . sinks
toilets & repairs . faucets . and more

thru the year...



Print Date June 1, 2018 Full Year Edition

Winter





**Need parts
& expert advice?
It's Easy at AMRE**

AMRE SUPPLY

Property Performance Centres

SUPPORT

“Our trained professionals are dedicated to helping with all your requirements”

- National Care Center
- Industry Trained Staff
- Dedicated Representatives

PRODUCTS

“Quality parts and products you need, in-stock and priced right!”

- Unsurpassed Selection
- Quality Products
- Trusted Brands

PROPERTIES

“We cater to all types of buildings - commercial to residential. Providing the parts and products you need”

- Commercial & Residential
- Hospitality & Healthcare
- Warehouse & Industrial

SERVICES

“At AMRE, you will find all of the tools and services you need to get the job done fast!”

- Special Order Services
- Online Tools
- Simple Solutions

CONNECTIONS

“With pickup locations and same day shipping, get your parts fast and easy!”

- Walk-in Locations
- Canada Wide Distribution
- Delivery Fleet



www.amresupply.com
1.800.661.9891

Across Canada . western . central . east

AMRE
Answer
Guide

AMRE . 24/7
we have you covered

Visit us instore
or online!



Website

www.amresupply.com
Amre's website has all of the tools you need to get all of your answers at a click of a button.



AmreMobileWebsite

AmreMobile website.
Look up model#'s, check pricing, check stock and place an order right from the palm of your hand! www.amresupply.com/mobile



Phone . Fax

Amre Customer Care
Friendly, helpful service from our industry experts!
Any questions, anytime!
We now have french speaking operators ready to take your call!



Email

customercare@amresupply.com
Send us questions or pictures of the "hard to find" parts you're looking for, we can help you out!



AmreChat

Instant Answers Online
Use the online Amre chat for fast knowledgeable customer service support.
Available during regular business hours.



Social Media

Facebook & Twitter
New product releases, events and online specials only available on the Amre Facebook & Twitter pages.

Locations Across Canada

Stop in one of our Amre store locations to see our great selection of products.



Order by 4pm for 24-48hr shipping to almost anywhere in Canada!

www.amresupply.com
1.800.661.9891



EDMONTON D/T MegaCenter

Edmonton S
5020 - 75 St.
(780) 461-2929
Fax: 780-465-4271

11413-120 St
(780) 426-2673
Fax: 780-784-1222

CALGARY MegaCenter

#101, 5760 - 9th Street SE
(403) 243-6662
Fax: 403-243-9368

RICHMOND MegaCenter

7671 Alderbridge Way
(604) 273-7377
Fax: 604-279-2310

Saskatoon
411A - 50th St. E.
(306) 955-2673
Fax: 306-955-3992

Surrey
#101, 5433 - 152 Street
(604) 575-9727
Fax: 604-575-5077

Winnipeg

1370 Sargent Ave.
(204) 775-8409
Fax: 204-786-5718

Hamilton

16 Brockley Drive
(905) 560-2673
Fax: 905-560-2405

SCARBOROUGH MegaCenter

2161 Midland Ave.
(416) 412-7278
Fax: 416-412-7890

London

1761 Oxford St. East
(519) 451-2300
Fax: 519-451-3361

Windsor

Unit 1, 5900 Rhodes Dr.
(519) 250-0000
Fax: 519-250-8621

MISSISSAUGA MegaCenter

Unit 5-4800 Eastgate Parkway
(905) 625-1267

Ways to Pay:

Convenient EXPRESS Account or our ENTERPRISE Charge Account.
Other methods of payment.

We accept:



CUSTOMER CARE

PH: 1.800.661.9891
FAX: 1.877.456.3336
customercare@amresupply.com

CREDIT BILLING

PH: 1.877.456.7448
FAX: 1.800.875.5893
accounts.receivable@amresupply.com

AMRE HEADLINES



ProPick

Let our AMRE pros pick the parts for you! Look for the ProPick symbol for our expertly chosen, tried and true recommendations. We have exactly what you are looking for, in-stock at your convenience. **AMRE Supply, making business easier everyday.**

Shipping Charge Change



As a result of increasing fuel costs and carrier fuel surcharges, we have decided to make a change to our flat rate shipping charge.

Effective May 9, 2018, our flat rate shipping within Provinces will be \$12.99, while Territories will remain at \$34.99.

We thank you for your continuous support and look forward to working with you in the future.

Don't Forget to Login to See Your Wholesale Prices!

We encourage you to **request a login on our website** to utilize more of the features that can save you time and money.

One of the biggest perks of logging in is **wholesale pricing!** Enjoy AMRE office tools, create shopping lists, view your purchase history, create and manage users, and view invoices, backorders and statements.



Our 50th year anniversary continues as 2018 goes by!

We are still **celebrating the past 50 years** and thanking our customers with special events, contests, exclusive sales, and so much more. To be informed of our **50th year celebrations**, keep a close eye on our website, subscribe to our e-newsletter, and follow us on our social media channels.

We'll be running our Gear Up promotion in July and November, 2018. **Any purchase over \$100 will receive a peel and reveal ticket to instantly win prizes!**

Keep watching our website for announcements on our annual Customer Appreciation BBQs!

On behalf of all the staff and management of AMRE Supply, we would like to take this opportunity to thank all of our customers for your business over the past 50 years. We appreciate your support and we look forward to an exciting future with greater milestones.

UPDATE

New Website Coming Soon

We are proud to announce that our new website is almost ready to be launched! The updated site will have a fresh new look, be mobile-friendly, and includes new features to make it easier to navigate. Stay tuned to our social media channels for the official launch date.



Did you know that you can lease equipment? We have partnered with National Leasing Company to offer you affordable payment options on a variety of our products. Leasing will allow you to easily upgrade your equipment while conserving cash.

Equipment leasing benefits:

- Get your equipment fast
- Increased buying power
- Custom payment streams
- Potential tax benefits
- Dedicated support
- Five-minute application
- 24, 36, and 48 month leases
- \$3500.00 Minimum



Waste Disposal Program



LED Retrofits



Equipment Programs



Mailboxes

24 HR.



Order by **4pm** for **24-48hr shipping** to almost anywhere in Canada!



Shipping

At AMRE Supply, we understand the importance of receiving your order quickly to ensure that your facilities needs are met. It is our goal to provide you with the best service possible in order for you to meet these needs, and exceed them.

24 Hour Shipping Promise

Local Delivery Area Destinations

Destinations within our branch locations' delivery area will be delivered Same or Next Business Day by our fleet of AMRE delivery trucks.

Out of Area Destinations

Any orders received by 4:00 p.m. local time will be shipped out within the Same Business Day. With 12 locations across Canada, shipments will reach most areas with 24 hours and 48 hours for more remote destinations.

Larger pallet orders shipped by truck may require more time.

Don't forget to login to see wholesale pricing

www.amresupply.com



We have hundreds of informative videos to help make maintenance easier, for all properties. These videos are sure to help you get the job done right, and done quickly, which means saving time and money. New videos and video series are constantly being added so make sure that you hit the subscribe button!

Specific model repair videos for Plumbing, HVAC, Appliance, Seasonal, and More...

Our different video series focus on: Lighting, Bathroom Faucets, Home Electronics, Flushometer Repairs, Janitorial Tutorials, Gas Furnaces, Humidifiers, Toilets, and Heating.

These and so much more can be found on the AMRE website and on our Youtube Channel!

**www.AmreSupply.com
www.Youtube.com/AmreSupply**



Seasonal Product Selection

AMRE has the parts and products you need to keep your property performing year-round!

Cold Weather

Ice Melters, Ice Scrapers, Snow Brushes, Snow Shovels, Spreaders, Milwaukee Heated Gear, Gloves

Warm Weather

Hoses, Pest Control, Shovels & Spades, Spray Guns & Nozzles, Spreaders, Sprinklers, Sunscreen, Wheelbarrows

All Season

Zone Valves, Janitorial Products, Lighting, Filtration, Boiler Repairs, Controls, Thermostats, and more.



LED Update



As LED technology continues to improve, the broad scope of LEDs available have replaced many incandescent and compact fluorescent lights. As incandescent and CFL's are phased out, AMRE Supply will be slowly removing incandescent and CFLs lamps from our inventory. LED's offer low wattages, higher light output, lower prices, **government incentive rebates, and traditional designs to make it an easier choice than ever.** We offer competitive pricing on our huge selection of LEDs.

If you find that choosing an LED can be confusing, **check out the helpful lighting tips on our website or watch the Lighting Spec. Sense series of videos on our YouTube** for brief information.

You can also contact our National Customer Care where they will guide you to choosing the right solution for your needs. In a quick minute, you will know what to look for when it comes to comparing brands or SKUs.

From lumen light output and colour temperature, to CRI and wattage, we will explain the differences so you can make the the best choice for your facilities needs.



New!

New Products!
Below is a list of
great new items so
watch for this **new symbol**
throughout!

Janitorial

- Rubbermaid Enhance.....9
- Rubbermaid Resist.....11
- Service Cart.....15,16
- Moving Blanket.....16
- Finish.....20
- Wood Floor Cleaner.....22
- Certainty Brand.....28
- Body Shampoo.....39
- Hand Cleanser.....41, 42
- Urinal Odour Barrier Fluid.....47
- Malodour Eliminator.....50
- Vehicle Air Freshener.....50
- Refresh Brand50
- Squeegees56
- Sponge.....57
- Brooms.....59
- Microfibre Mops.....62
- Bucket.....66
- Needle Disposal.....67
- Shop Vac.....74
- Vacuums.....76
- Vacuum Bags.....77
- Steam Cleaner.....85

Plumbing

- Urinal147
- Gasket151
- Flapper153
- Toilet Lever154
- Toilet Push Button.....157
- Delta Shower Head166
- Viega ProPress fittings173
- Sharkbite Hose Bibb.....174
- Frost-Free Wall Hydrant176
- Moen Faucet.....180
- Delta Faucet182
- Encore Repair Parts195
- Price Pfister Repair Parts202
- Valley Repair Parts206
- Flush Valve210
- Delta Repair Parts210
- Moen Flushmeter Parts216
- Toto Flushmeter Parts218
- Zurn Flushmeter Parts.....220
- Pump Accessories.....221
- Hot Water Tank Repairs.....223

Safety

- Needle Disposal279
- Hearing Protection.....280
- Gloves282, 283
- Pest Control.....285

Lighting / Electrical

- Fixtures.....91, 93, 95, 100, 101
- Extension Pole.....111
- Receptacle.....134
- Switches WIFI.....137
- Extension Cord.....140
- Smoke Alarm143, 144
- Door Bell.....146

Appliances

- Danby225
- Frigidaire.....226
- Fridge Parts228
- Range Parts.....229-232
- Ranghood.....233
- Dishwasher Parts236

HVAC

- Bathroom Exhaust Fans..239, 240
- KMC Sensors/Actuators254
- Zone Valve Parts255
- Boiler Maintenance.....263
- Humidifier Parts271
- Fans.....274
- Air Conditioners.....275
- Vacuum Pump276

Hardware & Tools

- Door Levers.....288
- Door Latches289
- House Numbers.....301
- Sliding Glass Door Pull.....304
- Window Roller308
- Mirror314
- PVC Cement.....320
- Gorilla Adhesive.....321
- Gorilla Tape323
- Gorilla Silicone.....326
- Garden Hoses334
- Striping Machines.....338
- Striping Paint & Stencils.....338
- Paint Covers.....340
- Knives.....341
- Milwaukee Stud Finder.....353
- Milwaukee Measuring Tape.....357

Table of Contents

Complete Year *edition!*

	Janitorial 8-85	
	Lighting/Electrical 86-146	
	Plumbing 147-223	
	Appliances 224-238	
	HVAC 239-276	
	Safety 277-286	
	Hardware 287-331	
	Seasonal 332-337	
	Tools 338-357	
	Index & Terms 358-363	

Check out these newly added items.

New!

Watch the Amre website for more great **NEW** items added regularly!

www.amresupply.com



THE TOUGHEST JUST GOT MORE PRODUCTIVE



- Bottom Handles
- Cinches
- Venting Channels



37.9L (10gal) 15-5/8" D X 17-1/8" H Bag: 26" x 36"			
261000GRAY	Gray	261000WHT	White
261000YEL	Yellow	261000RED	Red
75.7L (20gal) 19-1/2" D X 22-7/8" H Bag: 30" x 38"			
1779734	Black	262000GRAY	Gray
262000WHT	White	262000YEL	Yellow
262000RED	Red	262073BLUE	Blue Recycle
121.1L (32gal) 22" D X 27-1/4" H Bag: 35" x 47"			
1867531	Black	263200GRAY	Gray
263200WHT	White	263200RED	Red
263200YEL	Yellow	263273BLUE	Blue Recycle
166.6L (44gal) 24" D X 31-1/2" H Bag: 42" x 48"			
264360BLA	Black	264360GRAY	Gray
264360WHT	White	264360RED	Red
264360YEL	Yellow	264307BLUE	Blue Recycle



Bottom Handles:
Allow for easier dumping & handling

Cinches:
No more tying knots with 4 cinch positions

Venting Channels:
50% easier to remove with no vacuum effect



BRUTE CONTAINER ACCESSORIES

LIDS

Part#	Description	Colour	FIG.
260900GRAY	Lid for 2610	Gray	A
260900WHT	Lid for 2610	White	A
260900RED	Lid for 2610	Red	A
260900YEL	Lid for 2610	Yellow	A
261960GRAY	Lid for 2620	Gray	A
261960WHT	Lid for 2620	White	A
261960RED	Lid for 2620	Red	A
261960YEL	Lid for 2620	Yellow	A
261960BLA	Lid for 2620	Black	A
263100GRAY	Lid for 2632	Gray	A
263100WHT	Lid for 2632	White	A
263100RED	Lid for 2632	Red	A
263100YEL	Lid for 2632	Yellow	A
1867532	Lid for 2632	Black	A
264560GRAY	Lid for 2643	Gray	A
264560WHT	Lid for 2643	White	A
264560RED	Lid for 2643	Red	A
264560YEL	Lid for 2643	Yellow	A
264560BLA	Lid for 2643	Black	A



LIDS

Part#	Description	Colour	FIG.
263788GRAY	For 2632	Gray	B
263788RED	For 2632	Red	B
264788GRAY	For 2643	Gray	B
264788RED	For 2643	Red	B
265788GRAY	For 2655	Gray	B
354300GRAY	For 2632	Gray	C
1788376	Lid for 32gal	Blue	D
1788378	Lid for 32gal	Blue	E
1788380	Lid for 32gal	Blue	F

DOLLY

Part#	Description	Colour	FIG.
264000BLA	F2620 to 2655	Black	J
264600BLA	Tandem foldable 2620 to 2655	Black	K



CADDY BAGS

Part#	Description	Colour	FIG.
9W8700YEL	For 2643	Yellow	M
HC0039	Caddy Bag	Yellow	N

N



M





9510G
Lid sold separately

Interchangeable, colour-coded tops

Part#	Description
9510G	87.1L (23gal) (30" Hx20" Lx11" W), Grey
9512	87.1L (23gal) (30" Hx20" Lx11" W), Black
9513	87.1L (23gal) (30" Hx20" Lx11" W), Blue Recycle
9501G	Paper top for recycle bins
9503	Bottle and Can top for recycle bins
9515	Swing lid

Globe Slim Container is space efficient. Perfect for restaurants, bars, hotels, and anywhere with tight spaces. Colour-coded lids for waste separation: slotted blue top for paper; green round-hole top for glass bottles, jars, and metal cans; black swing top for general refuse.
(Min bag size: 30" x 38")



Untouchable Square Recycling Container

Part #	Size	Dimensions	Min. Bag Size
356973BLUE	87.1L (23gal)	16.5"x15.5"x30.9"	32"x42"
395873BLUE	132.5L (35gal)	19.5"x19.5"x27.6"	40"x42"

Accessories	Size	Description
269000BLUE	87.1L	Paper recycle
279400DBLUE	132.5L	Paper recycle
269100BLUE	87.1L	Bottle/Can
279100DBLUE	132.5L	Bottle/Can



Rubbermaid Sleek design for professional look, c/w recycle symbol and bag cinch.



Pro GRADE

Commercial Recycling Box

571473BLUE	14gal	20.75"L x 16"W x 14.75"H
571873BLUE	18gal	25.75"L x 16.5"W x 26.5"H

Rubbermaid Built-in handles, stackable or nesting, Commercial grade for years of use indoor and out.



Desk Side Recycling Container

Part#	Size	Dimensions
295573BLUE	12.9L(13.58qt)	11.4"x8.25"x12.1" H
295773BLUE	39L(41.25qt)	15.25"x11"x19.9" H

Min. bag size 20" x 22"
Min. bag size 26" x 30"
Rubbermaid Container c/w recycling symbol, Perfect solution to place beside desk side trash cans.



Recycling Containers

315	2 hole wall mount
316	3 hole free standing

FROST Blue and grey two tone finish. Includes two plastic liners and category labels in French and English. Optional metal liners (315-500G). Each liner has a 67L (17.7gal) capacity.
316 additional features:
Anchors included to secure, indoor and outdoor, adjustable feet, tumbler lock and keyed.



New!



Ask us about Rubbermaid ENHANCE Commercial Products.
Affordable and designed to fit your look and space!





6.6L (7qt) 8-7/8" L x 6-3/8" W x 10.8" H

254000BEIG Beige
(Min bag size: 20" x 22")



13.2L (14qt) 11-1/8" L x 8-1/4" W x 12-1/4" H

254100GRAY Gray
254100BLA Black
254100BEIG Beige
(Min bag size: 20" x 22")



Rubbermaid Fire Resistant Wastebasket. Long lasting fiberglass, resists chips and dents



12.9L (13.5qt) 11-3/8" L x 8-1/4" W x 12-1/8" H

295500BEIG Beige
295500BLA Black
(Min bag size: 20" x 20")



26.6L (28qt) 14-3/8" L x 10-1/4" W x 15" H

295600BEIG Beige
295600BLA Black
(Min bag size: 24" x 24")



39L (41qt) 15-1/4" L x 11" W x 19-7/8" H

295700BEIG Beige
295700BLA Black
(Min bag size: 26" x 30")
Rubbermaid Wastebaskets. All plastic construction, rolled rims, easy to clean



Fire Resistant Models also available



Round Metal Wastebasket

1302GY 27L

Manufactured from high quality steel with baked enamel finish. Reinforced wire rims for extra strength.

Rubbermaid SlimJim containers

Stainless Steel w/Black

Part #	Size LxWxH	Step
1901985	30L 17"x13"x22"	Front
1901986	30L 22"x10"x23"	End
1901992	50L 18"x14"x29"	Front
1901993	50L 23"x12"x29"	End

*Sizes are rounded

SlimJim containers are the perfect choice for any environment. FM approved, large foot pedal clearance, minimize noise, Liners sold separate see website, also available in 15L or 90L and other colors, dual recycling liners also available

FEATURES:

Slim Profile, small footprint. Fingerprint resistant stainless. Internal hinge protects walls. Liner retainer and cinch

Resin (Plastic) Black

Part#	Size	Step
1883609	30L 17"x11"x21"	Front
1883610	30L 20"x12"x22"	End
1883611	50L 18"x12"x28"	Front
1883612	50L 21"x14"x28"	End

*Sizes are rounded



1883609
Front Step



1901986
End Step

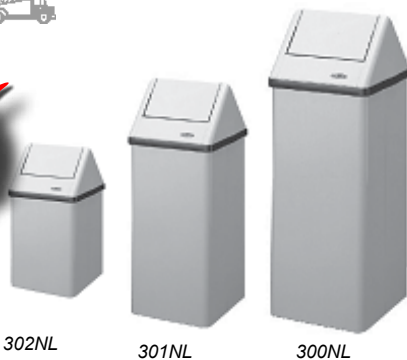

302NL

301NL

300NL



303-3NL



304-NL

Flip lid garbage can - White

Part #	Size/Dimensions	Bag	Liner
302-NL	(54L/14gal) 13 3/4"W X 14 3/4"D X 26 3/4"H	26" X 36"	no
302	(41L/11gal) 13 3/4"W X 14 3/4"D X 26 3/4"H	26" X 36"	yes
301-NL	(80L/21gal) 13 3/4"W X 14 3/4"D X 34 3/4"H	26" X 36"	no
301	(64L/19gal) 13 3/4"W X 14 3/4"D X 34 3/4"H	26" X 36"	yes
300-NL	(105L/28gal) 13 3/4"W X 14 3/4"D X 42"H	35" X 50"	no
300	(80L/21gal) 13 3/4"W X 14 3/4"D X 42"H	35" X 50"	yes

FROST garbage containers with flip top lid.

Liners: 300-500 fits 300 Models, 301-500 fits 301 Models, 302-500 fits 302 Models

Complete Tops: 300-501 fits 300/301/302

Flip lid garbage can

Part #	Size/Dimensions	Colour	Bag Size	Liner
303	(50L/11gal) 15 3/4"W X 8"E X 33"H	White	26" X 36"	yes
303-NL	(50L/11gal) 15 3/4"W X 8"E X 33"H	White	26" X 36"	no
303-3	(50L/11gal) 15 3/4"W X 8"E X 33"H	S.S.	26" X 36"	yes
303-3NL	(50L/11gal) 15 3/4"W X 8"E X 33"H	S.S.	26" X 36"	no
304-NL	(77L/17gal) 21"W X 8"E X 39"H	White	35" X 50"	no

FROST garbage containers with flip top lid.

Liners: 303-500: For code 300, 80 litres (21 US, 17.5 imp. gal.), Dim: 23" x 13-1/4" x 7-1/4".

Complete Tops: 303-501:fits 303 white, 303-3-501:fits 303S.S.





57 Litre (15 Gallon) 15-3/8" D x 36-1/2" H
816088BEIG Beige
816088BLA Black
816088BRN Brown
 Rubbermaid Marshal Classic Container. Rugged construction resists dents and scratches, indoor use, fire safety.
25 gallon Avail. 3550 - Rigid Liner sold separate
Bag Size: 35" X 47"



170.3L (45gal) 24 7/8" L X 24 7/8" W X 41 1/2" H
917388BEIG Beige
917388BLA Black
 Rubbermaid modern styling and easy-to-service. For stadiums, parks, shopping malls and other high-traffic areas. Pedestal base ring for stability and security. 4 Openings.
Bag size: 42" X 48"



9W0000BLA 9W0100BLA 9W0400BLA

132.5L (35gal) 31"H x 24"L x 24"W
9W0000BLA Blk Funnel Top
9W0100BLA Blk Dome Top
9W0400BLA Add on window wash kit
 Rubbermaid Landmark series container. Style combined with functionality. Bolt down base for stability.
Bag Size: 42" X 48"



125L (28gal) 18.5"D x 30"H
310-S Satin Stainless Steel
 Ideal for high traffic areas requiring the quality and durability of an all stainless unit without the commitment of wall mounting. Perfect for lobbies and reception areas.



160L (42.3gal) 28.5" H X 23" D
2020-RED
2020-BLACK
2020-GREEN*
2020-YELLOW
2020-BLUE
 Frost Stingray Waste Receptacle. All metal construction, rotational moulded heavy duty plastic liner. Side opening, latch closing.
Customized colors also available.
Bag Size: 35" x 50"



BRUTE® Rollout Container

9W2700GRAY	Gray	189.3L (50gal)
9W2773BLUE	Blue Recycle	189.3L (50gal)
29.8" L X 23.3" W X 36.8" H		
9W2100GRAY	Gray	246.1L (65gal)
9W2173BLUE	Blue Recycle	246.1L (65gal)
29.8" L X 25.3" W X 41.8" H		
9W2200GRAY	Gray	359.6L (95gal)
9W2273BLUE	Blue Recycle	359.6L (95gal)
35.4" L X 27.3" W X 45.6" H		

Molded in foot tilt helps manoeuvre heavy loads.
Blue is Recycle.



76L (20gal) 17" Dia. X 25" H
12143NL
 All Galvanized cans and lids are made of 30 gauge metal.
12143L Lid for 12143NL
Bag Size: 26" x 36"



New! Dent Resistant. Corrosion Resistant
 Fade & UV Resistant. Stain & Graffiti Resistant

Ask us about Rubbermaid RESIST Commercial Products.
 Combining lasting durability with designer looks to compliment any environment



New Upgraded Series Garbage Bags!

We are happy to announce our new series of Garbage Bags garbage bags by Polyethetics

GG Series

Polyethetics is the first manufacturer to use 100% recycled material to create 100% degradable products which are 100% recyclable, but that doesn't have to mean a lesser quality bag. Try and see the Polyethetic difference

Utility - Good for light trash, kitchen and waste basket liners

Regular - General use, all purpose bag

Strong - Good for heavier garbage

Extra Strong - Thicker and stronger, for extra strength needs

XX Strong - Super strength for demanding needs

XXX Strong - Contractor grade 3mil thick, highest quality

High Density - Premium quality for wet trash, good for food service areas



2800 Series Frosted High Density

Premium quality with exceptional strength. Ideal for heavy wet trash. Popular for food service, malls, lunch rooms, office areas, laundry etc... Packed in easy to dispense mini rolls

Garbage Bags

New Part#	Size	Capacity	Qty.	Strength	Price
Black					
GG2022RB	20" x 22"	32 to 45L	500	Regular	
GG2224RB	22" x 24"	32 to 45L	500	Regular	
GG2636RB	26" x 36"	45 to 71L	250	Regular	
GG2636SB	26" x 36"	45 to 71L	200	Strong	
GG2636XSB	26" x 36"	45 to 71L	125	Extra Strong	
GG3038RB	30" x 38"	77 to 98L	250	Regular	
GG3038SB	30" x 38"	77 to 98L	200	Strong	
GG3038XSB	30" x 38"	77 to 98L	125	Extra Strong	
GG3550RB	35" x 50"	115 to 187L	200	Regular	
GG3550SB	35" x 50"	115 to 187L	125	Strong	
GG3550XSB	35" x 50"	115 to 187L	100	Extra Strong	
GG3550XXSB	35" x 50"	115 to 187L	75	XX Strong	
GG3550XXXSB	35" x 50"	115 to 187L	50	XXX Strong	
GG4248SB	42" x 48"	125 to 225L	100	Strong	
GG4248XSB	42" x 48"	125 to 225L	100	Extra Strong	

Frosted . White . Clear . Blue Garbage Bags

New Part#	Size	Capacity	Qty.	Strength	Price
White					
GG2022RW	20" x 22"	32 to 45L	500	Regular	
Clear					
GG2636RC	26" x 36"	45 to 71L	100	Regular	
GG3038RC	30" x 38"	77 to 98L	250	Regular	
GG3550SC	35" x 50"	115 to 187L	125	Strong	
GG3550XSC	35" x 50"	115 to 187L	100	Extra Strong	
GG4248SC	42" x 48"	125 to 225L	100	Strong	
GG4248XSC	42" x 48"	125 to 225L	100	Extra Strong	
Frosted High Density					
2822-90	20" x 22"	32 to 45L	1000	Utility	
2863-90	30" x 38"	77 to 98L	500	Regular	
2875-90	36" x 50"	115 to 187L	250	Strong	
2877-90	43" x 48"	125 to 225L	200	Strong	
Blue					
GG2636RBL	26" x 36"	45 to 71L	250	Regular	
GG3038XSBL	30" x 38"	77 to 98L	125	Extra Strong	
GG3550XSBL	35" x 50"	115 to 187L	100	Extra Strong	



A



B



C



D

Part#	Size	Use	Colour	Mil	Cap.	Case
A) 40242M	24" x 28"	Tall Kitchen	White	0.7	45L	30/cs
B) 31422	31" x 42"	XL Outdoor	Black	1	121L	20/cs
C) 33483	33" x 48"	Contractor HD	Black	3	159L	32/cs
D) 30482	30" x 48"	Lawn & Leaf	Clear	1	98L	20/cs

Looking for a specific brand, style, strength or size of garbage bag?

Ask our customer service team today. Many other options are available on request.

Calculator To Determine Bag Dimensions To Fit Round Containers

Diameter of Container:	_____ "
x 1.57083	_____ "
Bag Width =	_____ "
Diameter of Container	_____ "
/2	_____ "
+ Height of Container	_____ "
+ Overhang	4 _____ "
Bag Length =	_____ "



To Fit Square or Rectangular Containers

Total 4 Sides of Container:	_____ "
/2	_____ "
Bag Width =	_____ "
The smallest of the 4 sides	_____ "
/2	_____ "
+ Height of Container	_____ "
+ Overhang	4 _____ "
Bag Length =	_____ "





Cease-Fire Cigarette Butt Receptacle

26800 Gray
Flame-retardant poly won't rust, dent or crack. Simple to empty, tie-down notches, rain bonnet keeps rain out.



12 1/4" L X 12 1/8" W X 39 7/8" H

9W3000BLA Black
9W3000SSTON Sandstone
Tuscan Style, combines clean good looks with easy Groundskeeper® maintenance. Stainless steel snuff plate minimizes smoldering.



39" L X 13" W

9W3300AGBRNZ Bronze
9W3300BLA Black
Smoke management receptacles
All-metal construction, unobstructed funnels to reduce jamming. High-capacity receptacles for heavy traffic areas. Domed tops for weather resistance. Integrated padlock tabs provide security against tampering and theft.



Rubbermaid smokers pole.

R1SM Silver Metallic
R1BK Black
Simple space saving design. Durable aluminum UV powder coated construction. Quick release feature for easy maintenance.



12 1/4" L X 12 1/8" W X 39 7/8" H

257088BLA Black
257088BEIG Beige
257088BRN Brown
Classic style, restricted opening shields cigarette butts from view, weather and flow of oxygen. Two-piece design makes cleaning quick and easy. Inner galvanized steel canister securely holds large quantities of cigarette waste.



18" L X 11 5/8" W

9W3200SSBLA Stainless Steel
Smoke management receptacles
All-metal construction, unobstructed funnels to reduce jamming. High-capacity receptacles for heavy traffic areas. Domed tops for weather resistance. Integrated padlock tabs provide security against tampering and theft.



Frost Wall or Post Mounted Ashtrays

Part#	Size	Dimensions
908	1 L	9" H X 7" W X 3" E
909	2.3 L	13.5" H X 9" W X 5" E
909-100		48" H X 6" Post

Heavy duty all stainless unit is ideal for pedestrian common areas. 18 gauge stainless steel, 304, # 4 brushed finish (18 and 20 ga. on Code 908).
Replacement liner for 909 available, part# 909-500.



Frost Outdoor Ashtray (6L)

920F Black w/ Stainless Steel.
Manage entrance and smoking areas with style. 18 gauge stainless steel 304, black powder coating. Tumbler keyed locked, large capacity receptacle.
3-3/8" x 6" x 18-3/4"
Easy Install. Easy Cleaning. Holds 1,500-1,800 Cigarettes.

S25 White
B25 Black
Silica Sand. Used for all types of ash urns.
5 x 5lb bags



We carry many different styles and designs!
Need a quantity price quotation?
Contact us today, we can help!





Best Sellers

Mobile Collector - Black

- 9T1700BLA** Utility 1/2 Yard 300 lbs 56 3/4" L X 28" W X 38 5/8" H
 - 9T1800BLA** Standard 1 Yard 600 lbs 72 1/4" L X 33 1/2" W X 43 3/4" H
 - 130700BLA** Optional Lid 56" L X 28" W X 9" D
- Industrial strength construction transports heavy loads with ease. Seamless one-piece molded truck bodies with reinforced lip.



Mobile Collector - Black

- 9T1300BLA** Utility 1/2 Yard - 450 lbs
57 1/8" L X 26 7/8" W X 33 7/8" H
 - 9T1400BLA** Standard 1/2 Yard - 850 lbs
57 3/8" L X 26 7/8" W X 33 7/8" H
 - 9T2200BLA** Optional Lid 52" X 27 7/8" X 9" H
- Fits through standard commercial & onto elevators easily.



1881750

Mobile Collector - Black

- 9T1500BLA** Utility 1/2 Yard - 1250 lbs
70 3/4" L X 33 1/2" W X 42 1/4" H
 - 9T1600BLA** Standard 1 Yard - 2100 lbs
70 3/4" L X 33 1/2" W X 42 1/4" H
 - 9T2300BLA** Optional Lid 66 5/8" X 34 1/2" X 9" H
- Fits through standard commercial & onto elevators easily.



Rubbermaid Collapsible X/Cart.

- 1881749** 4 Bushel
24.1" L x 20.3" W x 24" H
 - 1881750** 8 Bushel
35.7" L x 24.1" W x 34.6" H
 - 1881781** 2 x 4 Bushel
35.7" L x 24.1" W x 34.6" H
- Durable, easy to maneuver basket truck efficiently transports large, bulk loads, then conveniently collapses to minimize storage footprint. Easy clean detachable bag, premium casters with bumper guards. *220lb capacity.*

Mobile Collector - Black

- 130400BLA** Utility 1/2 Yard - 450 lbs
56 3/4" L X 28" W X 38 5/8" H
 - 130500BLA** Standard 1/2 Yard - 850 lbs
60 1/2" L X 28" W X 38 5/8" H
 - 130600BLA** Heavy Duty 1/2 Yard - 1400 lbs
60 1/2" L X 28" W X 38 5/8" H
 - 130700BLA** Optional Lid 56 1/2" L X 28 1/2" W X 9" D
- Inset wheels, protect walls, fixtures & patrons. Easy to clean & resists pitting & corroding. *Optional domed lids available.*



Spring Platform Trucks - Black

- 461100BLA** 14cu.ft 500lbs 44 1/8" L x 31" W x 32 1/2" H
 - 461800BLA** 20cu.ft 600lbs 48" L x 34 1/8" W x 36 1/2" H
- Spring platform brings contents to a convenient working level for safer and less-fatiguing handling of material. Conceals loads without reducing capacity.



Waste Collection Trucks - Gray

- Standard series**
- 460800BLA** 8cu.ft 300 lbs 38" L x 26" W x 28 1/8" H
 - 461200BLA** 12cu.ft 400lbs 42 3/4" L x 28" W x 33" H
 - 461900BLA** 20cu.ft 600lbs 48" L x 34 1/8" W x 36 1/2" H

Executive series with quiet casters

- 1867538** 12cu.ft 400lbs 42 3/4" L x 28" W x 33" H
- 461400BLA** 14cu.ft 500lbs 44 1/8" L x 31" W x 32 1/2" H
- 461600BLA** 16cu.ft 500lbs 43 3/4" L x 31" W 37" H
- 1867537** 16cu.ft 1000lbs 43 3/4" L x 31" W 37" H
- 460900BLA** Optional Lid 4608 38 3/4" L x 25 3/4" W x 8 1/2" H
- 461300BLA** Optional Lid 4612 43 1/8" L x 27 1/2" W x 8 1/2" H
- 461500BLA** Optional Lid 4614/4616 44 1/8" L x 31" W x 8 1/2" H
- 461700BLA** Optional Lid 4619 48 1/2" L x 34" W x 8 1/2" D



Material transport and laundry handling. Metal frames, durable support. Conceals loads without reducing capacity. Diamond wheel placement for manoeuvrability.

Mega Brute Mobile Collector

- 9W7300BLA** 120gal/400lb cap., 52.5" L x 27.5" W x 42.5" H
 - 9W7200BLA** Optional lid
 - 354060BLA** SlimJim 23gal optional
- Highly manoeuvrable, versatile waste and linen collection and sorting system. *Can liner retainer, large 12" wheels and 5" non marking locking casters, easy access rear doors, storage area and more.*





3 Shelf 38-7/8" L x 20-1/8" W x 38" H

9T6800BLA
300lb, smooth casters, quiet rolling easy cleaning. Elegant and versatile. Ergo design. Solid gentle bumper bottom.



3 Shelf - with wheels

5001G
33" L x 17" W x 37" H, 200lbs cap.
5002G
40" x 19" W x 37" H, 300lbs cap.
Strong, sturdy handles. Ideal for offices, restaurants, healthcare facilities, or hotels.



Trademaster Cart w/4 drawers

451388BLA
40-5/8" L x 18-3/8" W x 33-3/8" H, 500lb cap.
453388BLA
1 Door 49" L x 26-1/4" W x 38" H, 750lb cap.
Low maintenance, rust, dent and chip proof.
5" Non-marking castors, c/w key lock.
Black/Red



31-1/2" L x 27" W x 42" H

9T5700BLA
9T5800BLA w/1 cab.
Commercial Grade Ladder Cart. Carries 6ft. ladder, will hold long items, tools all in a minimal space that is easy to manoeuvre.
Black/Red. 500lb cap



Service Cart 39-3/4" L x 17" W x 33" H

22325
Accommodates up to 500lbs.
Lightweight and easy to maneuver.



38" L x 19-1/4" W x 33-3/8" H

618000BLA
618088BLA w/locking Cab.
Trades Cart w/5" quiet castors. 4 compartmentalized boxes. 2 storage bins for tools & supplies. *330lb cap.*
Black/Red.



Lipped Shelf H.D. Utility Cart

450088BLA
39" L X 17-7/8" W X 33-1/4" H
452088BLA
45-1/4" L X 25-7/8" W x 33-1/4" H
1867535
36" L x 24" W x 32-1/4" H
Rubbermaid Exec Series w/5" quiet casters. Perfect for transporting materials, supplies and heavy loads. Won't rust, chip, dent or peel. 4" castors. Ergo handle. *Molded in storage compartments, holsters, hooks & notches.*
Black. 500lb cap



32-5/8" L x 19-7/8" W x 33-1/2" H

773488BLA
5 Drawer mobile work center. Built in cord wrap, peg board side panels, locking castors & lock bar for security & safety.
Black/Red. 250lb cap



Heavy Duty Adaptable Utility Cart

1997206 46-1/5" L x 17-4/5" W x 36" H
1997208 51-1/2" L x 25-1/5" W x 36" H
Rubbermaid Heavy Duty Adaptable Cart. Superior versatility, 500lb capacity, black, shock absorbing rear locking castors, pipe cutting notch, 2" extra height

- FEATURES:**
- Adjustable handle
 - Tool slots
 - Flip up shelf
 - Small parts storage near handle
 - 2 Snap-in hooks
 - Grooves to add 1/2" plywood top



Work Smarter with Rubbermaid products! Available at Amre Supply!





Commercial Grade

36" L x 24" W

440300BLA 500lb cap.
440600BLA 1000lb cap.
Rubbermaid platform cart. Ideal for moving heavy large loads. 2 fixed/2swivel castors. Molded tie downs.



32-1/2" L x 20-1/2" W

440000BLA 250lb cap.
Rubbermaid utility cart. Sturdy structural foam deck won't rust, chip or peel. Easy on walls and doors. 3 position handle to push, pull or fold flat. Non-marking castors.



32-1/2" L x 20-1/2" W

440100BLA 500lb cap.
Rubbermaid utility cart. Sturdy structural foam deck won't rust, chip or peel. Easy on walls and doors. 3 position handle to push, pull or fold flat. Non-marking castors.



24" x 36"

C000403
Platform Cart. Quality steel construction, ribbed rubber mat, vinyl bumper, 2 swivel and 2 fixed 5" castors, *foldable handle, 660lb capacity.*



45-1/5" L x 23-4/5" W x 34-2/5" H

430000BLA
Rubbermaid convertible utility cart. Easily converts from a utility cart to a platform truck then folds flat for storage. 400lb capacity, (Utility)
 - Push buttons
 - Locking casters
 - Foot pedal
 - Recessed top
 - 2 Fixed, 2 swivel casters
 - Ergonomic innovative design



New!



60" L x 30-1/5" W x 45" H

446400BLA
A-Frame Panel Truck. Ideal for safely moving large, bulky sheet and panel goods. Single, 32" high side inclined frame & side rail holds load firmly in place while allowing for usable storage space for tools and supplies

3 configurations

61-1/2" L x 25-1/4" W x 42" H

449600BLA
Rubbermaid multipurpose convertible cart. 3 configurations platform, u boat and 2 shelf utility cart. 750lb to 1000lb capacity. Simple fast push button conversion. 2 fixed 2 swivel castors.



24" x 44"



24" x 52"



24" x 52"



H003780
Heavy duty convertible hand cart. 600lb capacity, all steel construction, converts easily from dolly to cart. 2 pneumatic tires.



H003787
BRICO Appliance Dolly with ratchet. All steel construction strap provides extra hold for appliances, ratchet mechanism for tightening strap. 440lbs. capacity, stair bumpers and 6" solid wheels



H003771
 Leaves a hand free for doors and steadying the load. Hauls up to 600 lbs. on 10" pneumatic tires. 49" H x 21" W, hand truck is made of 1" steel tubing, 14" x 8 3/4" toe plate.

New!



B003155
 Moving Blanket & Cover. 72" x 80"





Housekeeping Carts



60"L x 50"H x 22"W

618900BLA

Rubbermaid Executive Full Size Housekeeping Cart. Adjustable shelf, double bag capacity, durable 8" ball bearing locking castor wheels, full size cabinet, Durable commercial construction.

Janitor Carts



50-13/16"L x 20-7/8"W x 37-13/16"

3001

Cart w/ Yellow vinyl bag Globe Janitor Cart. Accommodates most buckets and wringers sizes, multiple hooks to hold brooms, dust pans and floor signs, includes 100L heavy duty zippered bag, 3" casters on front and 8" rugged casters on back



46"L x 21-3/4"W x 38-3/8"H

617388BLA

Cart w/ Yellow vinyl bag 618100YEL Opt. Locking Cabinet 1966719 Vinyl Replacement Bag Rubbermaid Cleaning Cart with Zippered Bag. Smooth easy clean surface, Rubbermaid quality, non-marking 8" wheels and 4" castors



38-1/2"L x 22-1/2"W x 20-1/2"H

1861429

Rubbermaid High Capacity Cart Executive Series, 40% more storage space, 4" quiet castors. Flexible and configurable. *Cart w/Black vinyl bag & 10 qt Sanitizing pails*



Perfect for smaller facilities

34-1/2"L x 11-1/2"W x 22-1/2"H

1861430

Cart w/Black vinyl bag Rubbermaid Executive Series Traditional Janitor Cart. Front platform for bucket, 11 tool hooks, front access zipper bag, lightweight, locking cabinet doors, waste cover.

51-1/2"L x 22"W x 44"H (Fig. A)

- A) 9T9200BLA 3 Bag Cart Only, Black
- B) 9T8100BLA Black Bag (Executive)
- B) 9T9300RED Red Recycle Bag
- B) 9T8000YEL Yellow Bag
- B) 9T9300GRN Green Recycle Bag
- B) 9T9300BLUE Blue Recycle Bag
- C) 9T9000BLA 9 Pocket Organizer
- D) 9T8400BLA 30qt Organizing Bin

Rubbermaid High Capacity Cleaning Cart.

High capacity bags (sold separately) provide multi-stream waste sortation for efficient, cost-effective recycling. Compact footprint - only 22" wide for easy mobility inside tight spaces. Rubber Tool Grips hold handles upright. Non-rusting and easy-to-clean aluminum and structural web plastic construction. Comfort Grip cart handle provides easy maneuverability and includes lobby dust pan/vacuum holder. 4" swivel casters and 8" wheels.



Don't see a style you are looking for? Give us a call, we have many other models available. Large job quotes available

Janitorial





Strippers



Geraldine - Nonammoniated Wax & Finish Stripper
 Unlocks the molecular structure of all types of waterbased floor finishes and sealers. Penetrates, dissolves and lifts the wax to the surface to be picked up easily

- 1040400** 3.78L
- 1040500** 18.9L
- 1045500** 208L



Extreme No-Rinse Floor Stripper

Developed to quickly strip multiple coats of burnished finish from a variety of floors. Rinse free.

- 1840400** 3.78L
- 1840500** 18.9L
- 1845500** 208L



Extra Ultra Ultra Concentrated Floor Stripper

High power, high productivity floor stripper is an ultra concentrated formula that penetrates and removes multiple coats of burnished finish with minimum labor. Rinse Free

- 1941200** 946mL
- 1944700** 2L Fastdraw



Champion Powerful Super Stripper

Labour friendly floor care. Formula effectively penetrates and power strips floor finish and sealer quickly and efficiently with minimal effort.

- DB52004** 5L
- DB52003** 20L



Dynamite Odourless Stripper/Degreaser

An effective stripper that penetrates deeply to remove stubborn sealers, finishes and heavy buildups. Odourless, fast acting, ideal for areas with sensitive air quality or involve 24/7 operations.

- DB52008** 5L



Formula-1 Powerful Super Stripper

Pleasantly scented powerful floor stripper, developed to penetrate and remove the worst floor finish build-up quickly and easily with a minimum amount of labour.

- DB52000** 5L
- DB52001** 20L



Neutralizers



Baseboard Stripper

Excellent foam cleaner which clings to vertical surfaces to remove floor finish and soil build up. Scented aerosol spray.

- DB50161** 510g



Film Away - Removes Icemelt Residue Neutral Film Remover

This neutral detergent with the Dustbane D.S.T. technology offers you a great cleaner, combined with a neutralizing feature for ice melter residues. Can also be used as a multitask cleaner that offers superior cleaning power and reduces the risk of leaving your floor with an unbalanced pH.

- DB51440** 4L



Floor Neutralizer & Cleaner (pH 1)

Effective penetrating action conditions floors by neutralizing and cleaning stripper residues before applying a water emulsion floor sealer or finish.

- DB53540** 5L



pH7 Neutral Daily Floor Cleaner

Emulsifies and suspends dirt and grime from table tops to floors. Won't attack, haze, dull floor gloss or leave a film.

- 1380400** 3.78L
- 1380500** 18.9L
- 1385500** 208L

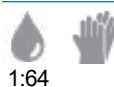

Sealers



Gard - Floor Sealer

Designed as a base coat to protect floors. It boasts superior levels of durability, is detergent resistant and leaves a smooth surface for the application of floor finish.

- DB53781** 5L
- DB50112** 20L



2-3



Floor Sealer

Acrylic sealer designed as a basecoat to protect floors for years. Hard, durable and detergent resistant, this sealer can be used on all types of resilient tile and terrazzo floors.

- 6070400** 3.78L
- 6070500** 18.9L
- 6075500** 208L



2-4



Glare Floor Finish

High gloss floor finish provides the optimum in durability and wear.

- 6050400** 3.78L
- 6050500** 18.9L
- 6055500** 208L



2-4



Hi-Tech Floor Finish

A floor finish breakthrough designed specifically to achieve outstanding performance when used in a high speed maintenance program.

- 6100400** 3.78L
- 6100500** 18.9L
- 6105500** 208L



2-4



Sealer/Finish



Accolade - Sealer/Finish

Seals and finishes in one easy step, providing exceptional gloss and leveling. Specifically formulated to protect both resilient and non-resilient floors.

- DB53784** 5L
- DB53785** 20L



2-3



Look for these helpful symbols throughout our Janitorial section.



Symbol Legend

- Wear Safety Goggles
- Wear Protective Gloves
- Contains Acid
- WHMIS Product
- CFIA Approved
- DIN Product
- Dilute with water
- Dilute with warm water
- Environment Safe
- Coats Recommended
- 1-3
- Time Saver
- Professional Grade
- Fire Resistant
- Environment Products
- Environmentally Improved
- High Efficiency Appliance

facts...

Floor finishes create a glossy, protective layer that keep your floors attractive and free of scratches and stains. However, over time these layers wear down and become dirty, and need to be removed before a new one can be reapplied. Floor stripping is all about completely removing old wax, soil and debris found on the floor. Generally it is one of the most labor intensive and time consuming jobs in the professional cleaning industry.



Finishes

New!



Hybrid Versatile Floor Finish

Polymer system formulated with XBF technology that provides the longest lasting finish ever. Self sealing extended wear formula retains film integrity and outstanding gloss even after repeated detergent mopping and burnishing.

6600400 3.78L



2-6



Untouchable with SRT Floor Finish

Low odor, black heel mark resistant floor finish that is an exceptional choice for those who want the highest gloss and wear with the least amount of labor. Scuff Resistant Technology

6060400 3.78L

6060500 18.9L

6065500 208L



2-4



Express with SRT Floor Finish

Fast drying, fast curing, and extremely low odor floor finish with superior black heel mark resistance. Formulated with Max-Cure Technology that utilizes a highly durable, internally cross-linked polymer specially blended to minimize dry and cure times.

6580400 3.78L

6580500 18.9L

6585500 208L



2-6



Hard As Nails - Hard Film Floor Finish

High gloss, long wearing finish that cures faster and harder than any other metal-interlock finish.

6590400 3.78L

6590500 18.9L

6595500 208L



2-5



Orbit - Floor Finish

Zinc Free, A.P.E. and VOC free, Multi-use, Rapid Recoating Developed for use in high profile areas, "Wet Look" gloss and durability.

DB52064 4L

DB52066 20L



1:4

1-3



Acclamation - All Systems Floor Finish

Fast drying formula, developed for use in high profile areas where the ultimate "Wet Look" gloss and durability are desired".

DB52060 5L

DB52061 20L



1-3



Gran-Prix XL - All Systems Floor Finish

Innovative floor maintenance solution. With its versatile, acrylic copolymer based formula, it's the perfect floor finish for all maintenance systems.

DB52020 5L

DB52021 20L



1-3



Elite - All Systems Floor Finish

Developed for use in high profile areas where the ultimate "Wet Look" gloss and durability is desired. 1-3 coats recommended.

DB52051 5L

DB52052 20L



1-3



Endurance - High Durability Floor Finish

Known for its maximum durability and minimal maintenance, it features exceptional gloss, wear and scuff resistance.

DB52158 5L



3



Glacier - High Solids Floor Finish

A true 25% high solids floor finish. By applying 1 to 2 coats, you will get the results of 3 to 4 coats of other floor finishes. This floor finish will save physical energy, labour and will lower maintenance costs.

DB53935 5L

DB53936 20L



1-3



Maintainers



Easy Task - Spray Buff

Spray buffing compound combines detergents, thermoplastics and solvent for the answer to terrific looking floors. Simply spray on floors and polish with a spray buff pad to easily remove black heel marks, scuffs and scratches leaving a wet look gloss.

6081200 946mL
6080400 3.78L



Betco One Step Restorer



Formulation effectively cleans the floor while restoring the top layer of finish.

6184800 946mL
6184700 2L Fastdraw
6180400 3.78L
6180500 18.9L



1:128

Challenger - Floor Cleaner/Maintainer



Cleans and restores gloss in one operation. Specifically formulated to clean floors maintained with ultra high-speed finishes. A floor finish that stays cleaner longer, reducing the need to strip floors. Works great on finished wood floors.

DB51330 5L
DB51332 20L



1:160



Best Scrub High Performance Cleaner

Effectively removes the top layers of soiled floor finish preparing the floor surface for recoating. Perfect product for any type of floor maintenance program to help extend the time between restorative stripping procedures.

6700400 3.78L
6700500 18.9L



1:15



Mr. Clean - Professional Floor Cleaner

Cleaning & shine preservation for shiny finished floors incl. ceramic & vinyl tile, terrazzo, & varnished hardwood. Fresh scent.

02621 3.78L



1:512



Spic & Span Professional Floor Cleaner

Versatile multi-purpose cleaner for floors, walls, restrooms, etc. Dual surfactant system emulsifies greasy soils and suspends them for easy removal.

02001 Reg (3.78L)



1:256

Floor Sweeping



Dust Mopping Dust mop treatment

An easy to use dust control for any surface. Eliminates dust created during the dusting task, reduces airborne dust while extending the life of your floor finish.

DB50159 375g Aerosol



Dust Mop Treatment

Designed to eliminate oily residue this water based dust mop treatment is compatible with all floor finishes and gym floor seals.

0352300 482g Aerosol



Floor Absorbent

Floor Dry Ultra absorbent. All purpose oil, grease and water. High absorbent volume.

RBC160 25lb



The original!

Sweeping Compound

Reduce airborne dust during sweeping & removal of dust & dirt from sealed, unsealed wood, concrete & metal floors. 100% Biodegradable and move "Recyclable plastic container to description and add Reusable, recyclable container

DB52509 22kg (50lb)
DB52100 100kg (225lb)



Amre carries repair & replacement parts for all Rubbermaid Products



Floor Cleaners



pH7 Ultra - Neutral Daily Floor Cleaner
Emulsifies and suspends dirt and grime from table tops to floors. Won't attack, haze, dull floor gloss or leave a film.

1784800 946mL
1784700 2L Fastdraw
1780500 18.9L
1785500 208L



1:256



pHerfect Floor Neutralizer & Cleaner

Formulated with neutralizing agents and surfactants to both penetrate and clean tough soils and neutralize ice melt stains. Ideal for conditioning floors after stripping and before coating.

5330400 3.78L
5330500 18.9L



1:64



Daily Scrub SC Heavy Duty Daily Floor Cleaner

Designed for floors which are frequently burnished, this product will quickly and completely remove deeply embedded soils.

1884800 946mL
1884700 2L Fastdraw



1:1024



Bioactive Solutions - No-Rinse Floor Cleaner

Formulated with detergents, emulsifiers, builders and proprietary BioActive bacteria that digest complex proteins starches and fats found in foodservice and other applications.

2584700 2L Fastdraw
2580400 3.78L
2580500 18.9L



1:64



Green Earth - Daily Floor Cleaner

For maintaining high gloss on finished floors. Will thoroughly wet, emulsify and suspend soil from highly polished floor surfaces without attacking the gloss of the floor.

5364700 2L Fastdraw
5360400 3.78L
5365500 208L



1:256



New!

PK Cleaner Wood Floor Cleaner

Quickly and efficiently cleans gym floors. Rapidly removes black heel marks and scuffs saving time and energy before coating the floor.

6900400 3.78L



1:64



Carpet Care

New!



FiberCAP MP Multi-Purpose Encapsulation Cleaner

Contains the most advanced technology in encapsulation chemistry. Enhances soil entrapment and provides better release from the carpet fiber.

4200400 3.78L



1:50



New!



FiberPRO TLC Carpet Degreaser & Traffic Lane Cleaner

Formulated to quickly penetrate and lift out grease and grime. Quickly loosens and emulsifies a variety of soils from both natural and synthetic fibers.

4060400 3.78L



1:50



FibrePRO Enzyme Deodorizer Organic Stain Remover & Deodorizer

Contains liquid bacteria which digest odor causes at their source. Special O3Z malodor counteractants prove instantaneous neutralization of odors and leave a pleasant fragrance.

4181800 473mL
4180400 3.78L



FiberPRO Dry Foam Carpet & Upholstery Shampoo

Highly concentrated blend of detergents and solvents which instantly emulsify oily soil, loosen dirt and trap it for easy removal.

4010400 3.78L



1:50



Cleaners



FibrePRO Bonbet Bonnet Shampoo

Formulation dries in less than one hour, is nonflammable, evaporates fast and cleans a wide variety of soils while leaving no residue.

4080400 3.78L



1:8



FibrePRO Spot Bet Spot & Stain Remover

All purpose carpet spotter combines detergent and deodorant technology to remove the most stubborn spots and stains. It effectively removes spots caused from a variety of oil and water-based stains.

4251200 946mL



CSQ EXTRACTION Cleaner Carpet Cleaner/Deodorizer/Sanitizer

Formulated to clean, deodorize and sanitize carpets. Contains a twin chain quaternary ammonium compound which reduces the growth of Gram-negative and Gram-positive bacteria. Ideal for use on carpets in health care facilities, hospitals, nursing homes, clinics, dentist offices and others.

DB53181 5L



1:80



Eco - EXPERT Carpet Cleaner

This neutral pH formula can be safely used on all stain resistant and colorfast carpets; works well with all Dustbane spot and stain removers. The blend of very low foaming surfactants will not clog vacuums, and allow recovery tanks to be completely utilized. Contains no phosphates. Certified UL 2795

DB53191 4L
DB53193 20L



1:256



Foam Suppressor



De-Foam Suppressor Extraction Machine De-Foamer

Dissipates foam in the recovery tanks of extraction carpet cleaning equipment, wet pick-up vacuums and automatic scrubbers. Unscented. Use 28-85ml directly into recovery tank

DB53156 5L



Dri-Foam Rotary Carpet & Upholstery Shampoo

Environmentally friendly: A.P.E. free, butyl free, phosphate free. For use on all types of carpeting, especially where there is heavy traffic. Recommended for use on colourfast fabrics only.

DB53042 5L



1:50



Spot / Stain Removers



Spot Shot Carpet Stain & Odor Eliminator

Proven to remove all kinds of tough stains old or new. Mud, dirt, soda, grime and much more.

WD00932 650ml



Stain Remover

Resolve Foam Carpet Cleaner is easy to use. Just shake and spray. Lifts out spots and stains. Cleans and deodorizes large carpet areas. Adds stain repellent to make future cleaning easier.

41015 623g



Tips for spot cleaning

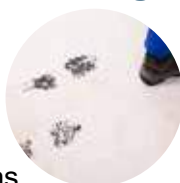

How To Remove: Ground-In Dirt Stains

1. Vacuum first to remove any loose pieces
2. Spray spot cleaner on
3. When dry, vacuum thoroughly



How To Remove: Pet Stains

1. Remove solid residue and blot excess moisture with a towel
2. Spray spot cleaner on
3. Blot with a clean, damp towel



How To Remove: Coffee Stains

1. Blot as much coffee out with a clean, damp towel
2. Spray spot cleaner on
3. Blot with a clean, damp towel



All Purpose



Lysol Multi-Surface

All-Purpose Cleaner. Pourable cleaner can be used on hard, non-porous surfaces. Kills 99.9% of bacteria. 1.2L

RC78909 Lemon
RC78910 Orange



Lysol All Purpose Cleaner and Disinfectant.

Powerful cleaning and freshening. Kills 99.9% of bacteria including Salmonella, E.coli, Listeria monocytogenes, Staph, HIV-1. Lemon Scent

75227 650ml



Fantastik ready-to-use

All purpose cleaner, for quick easy removal of dirt and stains. Pleasant fresh scent

95008 650ml
483223 3.78L



Pure White Vinegar

Household cleanser, for killing most mold, bacteria, and germs. Environmentally friendly and very economical. 5% acetic acid.

PIVIN18 5L



Industrial Vinegar

Can be used to clean a wide variety of surfaces. Kills bacteria, mold and mildew. Non toxic cleaner. 5% acetic acid.

DB53550 4L



1:50



Professional Comet with bleach

Formula has two short-chain surfactants that act like solvents to cut through grease and other soils. Perfume scent

10909 945ml
02291 3.78L



Preference - Neutral Cleaner

Everyone loves the sparkling clean floors and the fresh floral fragrance. This neutral cleaner, with its labour-saving no rinse formula, removes soil but leaves no residue.

DB55907 5L
DB55910 20L



1:80



Best Sellers

Crazy Clean Orange Citrus

All-Purpose Cleaner. Spray and wipe foaming natural orange solvent will clean almost anything with amazing results. Leaves fresh citrus scent.

985W 539g



For tough stains on toilet bowls, wall tiles, tubs, sinks, chrome, stainless steel, stove tops and ranges, pots and pans.

81393 400g



Spray Nine - Multipurpose

Removes all types of dirt, grease, grime, and stains!

26822 650mL Trigger
26832 946ml Trigger
26804 3.78L Refill



Spray Nine - Industrial Grade

Professional strength cleaner degreaser.

C13532 946ml
C13504 4L



Cleaner/Degreaser

Simple Green Concentrated is one of the most versatile all-purpose cleaners you can buy! It's non-toxic and biodegradable, without harmful bleach.

13005 3.78L



Bar Keepers Friend Spray and Foam

Versatile, multi-surface cleaning product. Works upside down without losing its prime. Removes mineral deposits, oily residues, rust stains and everyday grime

11724 750ml



Bar Keeper's Friend Quality Since 1882

For glass-ceramic cook tops, stainless steel cookware and pressure cookers. Unscented

11510 12oz
11514 21oz



Bar Keepers Friend Soft Cleanser

For kitchen & bathroom. Liquid cleanser with power of citric acid. Non abrasive, safe on brass, copper, porcelain, fiberglass, stainless steel and more

11600 13oz
11626BK 26oz



General Purpose



Spectaculoso
Multi-Purpose Cleaner

Clean and deodorize most water-washable surfaces with this fantastic lavender cleaner.

- 10234700** 2L
- 10030400** 3.78L
- 10035500** 208L



1:128

Top Flite
All Purpose Cleaner Concentrate

Clean and deodorize most waterwashable surfaces with this advanced formula.

- 1501200** 946mL
- 1504700** 2L Fastdraw
- 1500400** 3.78L
- 1500500** 18.9L
- 1505500** 208L
- 1502700** 1041L



1:64



Top Flite Plus
All Purpose Cleaner

This cleaner is effective on grease, oil, crayon, fingerprints, lipstick, smoke film, ink, coffee and cola stains on most washable surfaces.

- 0592300** 538g Aerosol



Green Earth
Natural All Purpose Cleaner

This versatile and dilutable cleaner quickly and effectively removes a variety of soils from any surface not harmed by water. Formula is designed to leave a lasting fragrance of clean.

- 1984700** 2L Fastdraw
- 1980400** 3.78L



1:64



Green Earth Peroxide Cleaner
Multi Purpose Cleaner

For daily use on floors, showers, glass and other hard surfaces. This one product can clean your entire facility. Removes mold stains and soap scum on tile, grout, bathtub surfaces and fixtures.

- 3291200** 946mL



Green Earth
Peroxide Cleaner

For daily use on floors, showers, glass and other hard surfaces. This one product can clean your entire facility. Removes mold stains and soap scum on tile, grout, bathtub surfaces and fixtures.

- 3364700** 2L FastDraw
- 3360400** 3.78L
- 3365500** 208L



1:64



Oxy-Q
Hydrogen Peroxide Based Disinfectant

Utilizes the power of hydrogen peroxide to create a non-toxic, complete cleaning solution. Dilute it according to your application — one product does it all.

- DB52880** 4L



1:256



Bio-Bac II - Bio-Based Cleaner/Deodorizer

A blend of surfactant and bio-cleaning agents (bacillus) that provides a revolutionary cleaning solution. It penetrates hard surfaces to remove organic soils in a safe and efficient way. This "people friendly" bacteria keeps working long after the initial application. Certified UL 2792

- DB53762** 4L



1:120



Choosing the right cleaning product using the pH scale:

Running from 0-14, the pH scale helps you to determine whether a substance is acidic or alkaline. A substance with a pH of 7 is neutral; anything lower than 7 is increasingly acidic, with 0 being the most acidic, & anything higher than 7 is increasingly alkaline, with 14 being the most alkaline.

Cleaning is an attempt to neutralise the impact of acidic or alkaline ions in a stain or soiling. So if you wish to clean a soil that is acidic, you should use an alkaline cleaning product, and vice-versa.



General Purpose Disinfectants



Pinosan

Offers a powerful cleaning, deodorizing and disinfecting performance. Its neutral quat formula has a broad spectrum of efficacy against bacteria, fungi and viruses and leaves a pleasant pine fragrance. DIN: 02213133

DB53016 5L
DB53017 20L



1:80



Vanguard

Concentrated version of Vanguard specifically formulated for the healthcare industry, cleans, disinfects and deodorizes in one labour-saving step. Neutral quat-based cleaner destroys bacteria, viruses, fungi and other microorganisms on hard surfaces. It also effectively inhibits the growth of odour-causing mold and mildew.

DIN: 02213095
DB53023 5L



1:160



Symplicity Sanibet Multi-Range Disinfectant

A versatile broad-range sanitizer, can be used to sanitize serving ware, utensils, pots & pans, and food processing equipment. It can also be used for disinfecting floors and walls.

2374707 2L FastDraw
2370407 3.78L
2370507 18.9L
2375507 208L



1:512



Fight-Bac Broad Spectrum Disinfectant

Quaternary based, anti-bacterial cleaner ideal for use in hospitals, nursing homes, schools and hotels. Provides excellent performance in cutting grease, heavy soil and filth with quick drying times.

3111207 946mL



Quat Plus - Disinfectant/Cleaner

Disinfectant and germicidal detergent with the cleaning performance of a neutral quat that eliminates malodour by destroying a wide range of bacteria, fungi and viruses without the harsh smell of chemicals. Effective against influenza A (H1N1). DIN: 02298694 Certified UL 2794

DB50232 4L



1:256



Daily Disinfect SC

A concentrated multi-purpose germicidal detergent and deodorant effective in hard water. Disinfects, cleans, and deodorizes in one labour saving step.

3554707 2L FastDraw
3250407 3.78L



1:256



Germicidal Cleaner

Convenient aerosol spray one step disinfectant and deodorizer. CFC free. Floral fragrance.

DB50158 539g



Professional Use bleach

****BE SURE NOT TO MIX WITH ANY OTHER CLEANER****
Removes stains, disinfects, and purifies. Made of Sodium Hypochlorite.

BN20 3.6 L, 6% bleach
AV3 5 L, 12% bleach



Professional Comet Disinfecting Bathroom Cleaner.

Patented, non-abrasive, full-strength spray cleaner for common restroom surfaces.

Citrus scent
35021 945ml
35023 3.78L



Disinfectant Spray Aerosol.

For use in hospitals, nursing homes. Bactericidal, Staphylocidal, Tuberculocidal, Fungicidal, Pseudomonocidal, Virucidal, Eliminates odours. Fruity scent.

15DIN 439g



General Purpose Disinfectants



Professional - Mr Clean

Multi-surface Disinfectant. kills 99.9% bacteria, great for kitchens, bathrooms, floors, garbage cans, pet areas etc... Summer scent

PG31504 3.78L



Pine Sol

Effective on grease and grime. Used to clean floors, counters, sinks, stoves, showers, tubs, tile, and toilet bowls; deodorizing garbage cans and pet areas.

40294 828ml

CL40153 4.25L



Household Ammonia

Excellent and budget-friendly cleaner. Used in commercial settings, leaves a streak-free shine.

L5500 4L



Lysol Kitchen Antibacterial Cleaner and Disinfectant.

Kills 99.9% of bacteria including Salmonella, E.coli, Listeria monocytogenes, Staph, HIV-1. Citrus Scent

50305 650ml



Lysol All Purpose Cleaner and Disinfectant.

Powerful cleaning and freshening. Kills 99.9% of bacteria including Salmonella, E.coli, Listeria monocytogenes, Staph, HIV-1. Lemon Scent

75227 650ml



LYSOL Disinfectant Spray

Kills 99.9% of viruses and bacteria on commonly touched, hard, non-porous surfaces. Crisp Linen scent.

34052 350g



Lysol wipes Pre-moistened

Disposable wipes clean, kills 99% of odour-causing germs and bacteria on non-porous surfaces in 30 seconds. 35 sheets

75552 Citrus

75553 Spring Waterfall



Oxy D.S.T.

Hydrogen Peroxide Based Cleaner

Combines the powerful cleaning and degreasing properties of Dustbane's Dynamic Surfactant Technology with the amazing stain lifting power of oxygen bleach. Certified UL 2759

DB53375 120 Wipes



Eliminate - One Step Cleaner, Disinfectant, Virucide and Deodorizer

Clean more with less. Clean and disinfect in just 4 minutes. Eliminates 99.9% of bacteria, leaving surfaces clean and disinfected

DB53377 180 Wipes



Triple Action

Cleaner, Degreaser & Disinfectant

3 in 1 cleaning solution. Reduce inventory, simplify your purchasing and maintenance program

DIN: 02322110

DB53376 120 Wipes



New!



A full line of wipes options
Sanitizing, Disinfectant, Disinfectant Plus,
Personal Care & Specialty Wipes



A complete line of Sanitizing Wipes for every facility.

The one-step Certainty™ Surface Sanitizing Wipe System is designed to reduce waste and minimize the work involved in maintaining a clean and healthy facility.



Surface Sanitizing Wipes

Kills 99.9% of germs in 60 seconds. Easy and convenient surface sanitizing with just one wipe.
WE96200 200 Wipes



Touch Screen Wipes

Alcohol Free and easily cleans dirt, grime, fingerprints and smudges from any electronic or touch screen.
56200 200 Wipes

Specially designed dispensers to best suit your facility and wiping needs.

Certainty™ has developed a complete line of dispensing equipment that promotes wellness and hygiene.



The perfect solution for fitness and gym equipment, offices, grocery stores, and more!

Disinfecting Wipes

Kills 99.9% of bacteria, viruses and fungi in just 10 minutes. DIN registered with Health Canada. Designed for high traffic or high use facilities. Uses a soft airlaid wipe for optimum surface coverage.

- 9685** Refill, 800 wipes, 2/cs
- C9WALLW** Wipes Dispenser, White
- C9STN** Dispenser Stand



Stainless Steel Floor Stand & Garbage
C9SSFS
Use with 9685 wipes



Available in both blue and black.
9118



9115



9019

- 9019-01** Large Wall Dispenser
- 9118-DS** High Capacity Sanitizing Wipes Station, Blue
- 9118-DS2B** High Capacity Sanitizing Wipes Station, Black
- 9115-02-CAN00** Refill Pouch, 1500 count, 2/cs (Fits 9118 / 9019)
- 90100-01PUR7** Our High Standards Start Here Sign Only

- One Wipe technology virtually eliminates roping, reducing retailer costs
- Easy pull dispensing prevents wipe fallback and bunching

New patent-pending nozzle features: re-wetting design ensuring consistent wipe saturation and germ-kill new nozzle ships with every case.



Detergents



**Excelsior
Hard Surface Cleaner**

Offers a cleaning solution with exceptional performance without the use of harsh chemicals. It offers superior cleaning efficiency therefore reducing labour. Certified UL 2759

DB50211 4L
DB50213 20L



1:256



Bio-Bac II - Bio-Based Cleaner/Deodorizer

A blend of surfactant and bio-cleaning agents (bacillus), revolutionary cleaning solution. Removes organic soils in a safe and efficient way. This "people friendly" bacteria keeps working long after the initial application. Certified UL 2792. **Good for pet odor.**

DB53762 4L



1:120



Compare - Neutral Detergent

A versatile, general purpose detergent. Its concentrated formula makes cleaning economical and efficient as only a small amount is required to complete the cleaning task.

DB51410 5L
DB51411 20L



1:160



Green Klean - Neutral cleaner and degreaser

A multi-use neutral cleaner and degreaser which can also replace many specialty products, thereby drastically reducing inventory and simplifying purchasing requirements. A highly efficient cleaning solution that is safe for the user and the environment.

DB51283 5L



1:160



Nu-Life - Soap Film Remover

Penetrates and dissolves hard water soap scum and deposits for easy and effortless removal. Lemon-mint scent. Also works on icemelt residue

DB51272 5L



1:80



**Pine Cleaner
Pine Oil Detergent**

An effective all purpose cleaner and deodorant fortified with pine oil.

DB55060 5L



1:40



Azure

All-Purpose, delivers exceptional performance, ideal for glass surfaces. Mild formula acts as a dust collector when sprayed lightly on a microfiber cloth and an excellent stainless steel cleaner. APE, VOC and ammonia free. Certified UL 2759

DB50202 750ml RTU
DB50201 4L



1:40



Power Wash

No scrubbing needed. Works great as a spray and wipe degreaser. Safe to use on decals at any strength. Fast acting formula. Contains an additive to dissolve and emulsify rust stains. Water-based, biodegradable, bleach and solvent free

DB51369 4L
DB51370 20L



1:80



Cost in Use

An important factor to consider when purchasing a product is the "cost in use". Comparing the liter's prices is not a good indication of the final price paid. The formula to obtain the cost in use is as follows:
(Price / Litre) / Total Parts From Dilution = Cost in Use

Here's an example:

Dilution	Price	Format
1:80	\$15.00	4 L

$$\$15.00 / 4 L = 3.75 / 81 = \$0.046$$



Food Service/Industrial Degreasers



Emerald

Its safe yet powerful formula effectively cuts through grease, oil, and heavily soiled surfaces. This biodegradable cleaner / degreaser is solvent free. Certified UL 2759

DB50203 750ml RTU

DB50206 4L

DB50208 20L



1:160



Power Kleen Cleaner/Degreaser

Non-butyl water-based cleaner & degreaser. Use on any surface where grease and oil residue are a problem. Lemon scent.

DB53220 750ml RTU

DB53215 5L



1:80



Triple Action - Liquid Cleaner/Degreaser/Disinfectant

In one easy step. Reduce your inventory while simplifying your purchasing decision and maintenance program with this 3-in-1 cleaning solution. DIN: 02240187

DB51345 750ml RTU

DB51347 5L

DB51349 20L

DB53376 120 Wipes



1:160

Industrial Degreasers



Power Lift Pressure Washer Cleaner

An industrial grade degreaser highly effective to quickly remove grease, oil, dirt and grime. Offers a performance superior to solvent based cleaners while being safe on all metal and non-metal surfaces, including rubber.

DB51359 4L



1:160



Orange-A-Tang Multi-use Solvent

A powerful citrus solvent that is effective on a wide range of spots and soils, including gum and tar as well as oil and grease.

DB53514 4L



1:80



Complex Orange Liquid Degreaser

Solvent free degreaser which quickly emulsifies and removes the toughest dirt and soils. Orange fragrance.

DB51413 4L



1:80



Resolve - Cleaner/Degreaser

An A.P.E. and butyl-free cleaner and degreaser recommended for use on any washable surface where dirt, grease and oily residue become a problem.

DB53209 5L

DB50142 20L



1:80



Bio-Bac II - Bio-Based Cleaner/Deodorizer

A blend of surfactant and bio-cleaning agents (bacillus), revolutionary cleaning solution. Removes organic soils in a safe and efficient way. This "people friendly" bacteria keeps working long after the initial application.

Certified UL 2792.

DB53762 4L



1:120



Kitchen Degreaser

A heavy-duty degreaser specifically formulated to instantly dissolve the greasy, oily soils found in commercial kitchens. This ultra concentrated fast acting product delivers unbeatable performance and true economy by saving you time and labor.

10121200 946mL RTU

10120400 3.78L



1:32



Citruspray Foaming Degreaser/Deodorizer

High foaming action quickly dissolves the toughest filth, grease, dirt, oil, wax, ink, resin, carbon, soot and soap scum.

1371200 946mL

1375500 208L





Trusted commercial grade cleaners for a professional result

Degreaser



Liquid Chisel Max
Ultra Strength Non-Butyl Degreaser
This ultra strength degreaser is perfect for cleaning concrete, floors, walls, machinery, engines, and a variety of other water washable industrial surfaces soiled with heavy grease or oil.

- 1450400** 3.78L
- 1450500** 18.9L
- 1455500** 208L
- 1452700** 1041L



1:100



Citrus Chisel
Non-Butyl Citrus Cleaner/Degreaser
Superior performance cleaner/degreaser. A synergistic mixture of natural citrus solvents and a totally unique surfactant system.

- 1671200** 946mL
- 1674700** 2L FastDraw
- 1670400** 3.78L
- 1670500** 18.9L
- 1675500** 208L
- 1672700** 1041L



1:100



Speedex
Heavy Duty Cleaner/Degreaser
This fast acting cleaner/degreaser instantly removes crayon, lipstick, graffiti, oil and heel marks from a variety of surfaces.

- 1731200** 946mL
- 1730400** 3.78L
- 1735500** 208L



Green Earth Velocity
Neutral Non-Butyl Degreaser
This versatile, dilutable dynamo quickly and effectively removes inks, oils, greases and fats from a variety of surfaces.

- 1974700** 2L FastDraw
- 1970400** 3.78L
- 1975500** 208L



1:64



Citrusolv Concentrate
Natural Degreaser & Deodorizer
Ideal for removing oily films from metal surfaces, unclogging drains and grease traps, removing tar from most hard surfaces, cleaning motors, removing adhesives, decals and many other difficult cleaning tasks.

- 2091800** 473mL
- 2090400** 3.78mL
- 2090500** 18.9L
- 2095500** 208L



1:132



Green Earth Natural Degreaser
Concentrated Hard Surface Industrial Degreaser
This powerful degreaser is the naturally preferred solution for all degreasing task. Breaks down greases, oils, and fats including industrial petroleum greases on all water safe surfaces.

- 2174700** 2L FastDraw
- 2170400** 3.78L
- 2175500** 208L



1:64



Since 1950, Betco has been a world-class leader in facility solutions. Our full line of products features over 350 innovative solutions for facility cleanliness. This, complemented by our full line of equipment and floor machines, makes Betco a one-stop shop for the highest-performing solutions in the industry. With innovation at our core, we are committed to researching end users' needs to predict and develop the next great facility maintenance solution.



Oven, Fryer, & Grills



Oven, Fryer, & Grill Cleaner

Designed to penetrate the deposits and break the chemical bond, releasing the baked-on deposits from the oven surface. This nonfuming product works fast and leaves a fresh fragrance behind.

10010400 3.78L



Oven Jell - Grill & Range Hood Cleaner

Premium fast-acting oven & grill cleaner formulated to cling to vertical surfaces providing long contact time for easier cleaning. More effective than foaming products this formulation quickly dissolves even the toughest soils.

1391200 946mL

1390400 3.78L

1395500 208L



Tiger Oven Cleaner

Spray and allow to work for 10 minutes. Wipe all surfaces clean with wet cloth breaks up grease and lifts heavy soils

AV612 510g



Oven Cleaner

Alkaline formula quickly and efficiently removes baked on grease, fat, soot and carbon. No C.F.C. Clinging foam, thick foam, use for immediate or overnight oven cleaning.

DB50170 510g



Easy-Off Fume Free

Cold-oven technology penetrates tough oven grease and effectively cleans with no harsh fumes and no lye. Lemon scent

00394 400g Aerosol



Fryer & Griddle Cleaner

Quickly Penetrates and Emulsifies Baked on Grease, Oil and Carbon on Metal Surfaces. Unscented. Contains a rust inhibitor. Free rinsing

DB53896 5L



1:40



Easy-Off Heavy Duty

Advanced grease-cutting formula for burned-on grease and grime.

00392 600g Aerosol

00404 475ml Trigger

Pro GRADE



Affresh Cooktop Cleaner

Removes and cuts through the toughest baked-on residue.

This non-abrasive cleaner is safe for all glass, ceramic and porcelain cooktops.

W10355051B 284ml



Microwave Cleaner



Microwave Cleaner

Steams to soften grunge and build-up. Foams away stains and odors for like new clean. Safe for all microwaves. Incl. 2 scrubbing sponges. Lemon Scent.

MW06T 2/pk



Freezer



Deep Freeze Cold Room & Freezer Cleaner

Hard working floor wall and equipment cleaner to use in all subfreezing cold storage and freezer areas. Removes dirt grime fat and grease deposits from hard surfaces this product works fast and will not harm concrete or leave a slippery residue

1320400 3.78L

1325500 208L



Why you need to clean your oven...

How often?

Cleaning your oven should be a monthly task, but you should wipe down the oven door **at least once a week.**

As with most things, the longer you leave it the harder it will be to get back into good condition.

Why?

Your oven can become less efficient at reaching temperatures and **eventually may just stop working** all together if burnt food is left unattended.

Crusty build up can also impact the taste of your food and, while high temperatures can kill some bacteria, it's not a good place to be cooking food.

tip



Dishwashing Detergent



Symplicity Tilly - Hand Dishwashing Detergent
 Economical lotionized neutral pH manual dishwashing detergent specially designed for industrial, institutional and restaurant use. Tilly produces an abundance of long lasting suds, works quickly and leaves surfaces spot and film free.
1100400 3.78L
1100500 18.9L



1:128



Symplicity Citrusuds - Hand Dishwashing Detergent
 A heavy duty lemon scented pot & pan detergent specifically designed for restaurant, institutional and industrial use where long lasting suds and easy removal of grease are a must.
21094700 2L FastDraw
21090400 3.78L



Dish Shine Liquid Dish Detergent
 High performance at an economical price. Recommended for hand washing dishes, glassware and silverware. Lemon fragrance.
DB55064 5L



1:600



Symplicity In-Sync Super Concentrated Hand Dishwashing Detergent
 Premium dishwashing detergent leaves dishes sparkling clean and film free. In-Sync is specifically designed for supermarket, institutional and restaurant use where fast grease emulsification and lasting suds are a must.
18511200 946mL
18510400 3.78L
18510500 18.9L



1:256



Symplicity Envy - Hand Dishwashing Detergent
 Powerful, grease fighting clean while remaining gentle on hands. Rich formula delivers a mountain of suds with every drop. Floral fragrance.
2119B900 946ml



Symplicity In-Sync - Hand Dishwashing Detergent
 Premium dishwashing detergent leaves dishes sparkling clean and film free. Ideal for cleaning pots and pans. Ocean fragrance.
1851B900 946ml



Finish PowerBall Dishwasher tablets.
 Fresh Scent. Brilliant streak free shine with JetDry powerball.
RC81158 60/pk



Dawn dish washing liquid.
 Orange scent. Anti-bacterial fast acting tough formula. Ultra concentrated.
22206 709ml



Sunlight manual Dish Liquid
 Designed for the institutional environment. Ideal for the greasiest dishes, glassware, cutlery or pots & pans. Citrus scent
2979769 6L



Cascade Dishwasher ActionPacs
 With Dawn Fresh Scent. Power to fight stains and rinse away tough food particles.
44601 25/pk



Cascade dishwasher detergent.
 Sheeting action for virtually spotless dishes. Specially formulated for use in automatic under counter dishwashers. Lemon scent
31683 3.51L Gel



Cascade dishwasher detergent.
 Sheeting action for virtually spotless dishes. Specially formulated for use in automatic under counter dishwashers. Fresh scent
31564 4.4KG Powder



Dishwasher Cleaner



Glisten dishwasher cleaner.
2-in-1 cleans freshens and maintainers dishwashers and removes cloudy film and spots from dishes and glassware
19045 4oz



Affresh Dishwasher Cleaner
Innovative cleaner tablets to help remove even the most stubborn odours from dishwashers. Fresh up to a month
W10288149B 3/pk



LimeFresh Dishwasher detergent booster
For hard water conditions, removes film, residue and nasty hard water spots. Enhanced cleaning power of phosphate free detergents. Up to 37 applications.
80527 750g



Symplicity L-S-R Delimer - Machine Descaler
Concentrated Delimer formulated with a blend of organic & inorganic acids combined w/controlled foam surfactants for superior performance. LSR Delimer contains an odor eliminating fragrance that eliminates the objectionable odor that occurs in use with other similar products.

2480400 3.78L
2485500 208L



FINISH Dishwasher Cleaner
Intensively cleans hard to see places in your dishwasher, use once a month
82887 8.45oz



Appliance Cleaner



Affresh Kitchen and Appliance Cleaner.
Cuts through everyday spills leaving a streak free shine.
W10355010B 473ml



Affresh stainless steel cleaner.
Leaves a streak-free and polished shine. Cleans fingerprints, smudges and residue from appliances and more

W10355016B 473ml Spray
W10355049B 35/pk Wipes



603 Green - Multi Purpose
604 Pink - Washroom
605 Blue - Glass
Microfibre hand cloths
Pick up twice the bacteria and dirt as common hand wipes.
5/pk



3131B Blue
3131P Pink
3131Y Yellow
3131G Green
Microfibre cloths
Perfect for all your commercial cleaning needs.

tip

Why Microfibre Cloths Are Great

- No lint or streaks left behind
- Can hold up to 8 times their weight in water
- Clean nearly any surface with just water
- Split fibres grab dirt and other particles
- Easy to clean and maintain
- Economical and eco-friendly



Laundry



Citro Laundry Detergent

Low suds powder laundry detergent for automatic washers (hot or cold water). Concentrated high quality, phosphate free formulation. Lemon scent.

CHLESS-15 18kg



Ultra Tide Professional

With oxy bleach. Specially formulated for professional fabrics and stains.

PG04000 6.29kg



Washer Fresh

HE Washer Fresh cleaning tablets. All High Efficiency Washing Machines are prone to odor-causing build-up.

80406 6 Tablets



Symplicity Duet-L with Bleach Alternative Laundry Detergent with Enzymes

All-in-One Liquid Detergent for residential style machines. Duet-L brightens & whitens and lifts stubborn dirt and stains. Performs well in all water temps. and safe for all types of waterfast natural and synthetic fabrics.

4750400 3.78L

4750500 18.9L

4755500 208L



Affresh Washer Cleaner Pucks. Removes and prevents odor causing residue in all brands of washers.

W10135699 3/pk



Disposer Cleaners



Disposer Care

Powerful blue foam strips away food particles, grease, and odour causing grunge. Cleans entire disposer. Lemon Scent.

DP06N-PB 4/pk



Plink Garbage Disposal Cleaner

Quick and Easy to Use. Washes Away Foul Odors. 10/pk

PLM12T Lemon

PCO12T Orange



Specialty Cleaners



Brasso

Leaves a smooth polished surface and a brilliant shine. Cleans, polishes and protects brass, copper, chrome, stainless steel and pewter.

00049 142ml



Stainless Steel Cleaner.

Provides performance and gloss, with no excessive residue, no hazing and no excessive buffing required.

DB50172 397g



Stainless Steel Cleaner

Polishes, protects stainless steel without scouring. Resists fingerprints, grease, and water spatter; preserves factory finish.

841W 425g



Sheila Shine

Removes dirt and grime, greasy film, water marks, it even covers scratches!

81000 10oz



Stainless Steel Cleaner & Polish

Oil in water emulsion - the best combination of ingredients to remove both water & oil-based soils, stains, and spills. Ideal for all brushed and high gloss metal surfaces.

0652300 482g Aerosol



Scratch-B-Gone Kit

Make it look like new, again! Removes scuffs fine scratches and deep scratches. Remove chemical discoloration caused by cleaning products, bleach and acids from your appliances. Remove rust and heat scorching.

W10296904RM 20-25 appl./pack.



Removers



FibrePRO Gum Remover

Quickly and easily removes chewing gum, candle wax and other gummy substances. The fast-freezing action of this gum remover simplifies clean up by freezing the gum so that it can be popped off with a putty knife.

0092300 198g Aerosol



Chewing Gum Remover

The ideal solution to quickly and easily remove chewing gum and candle wax.

DB50163 235g



Chewing Gum Remover

Removes gummy substances, candle wax and putty with minimum effort. Freeze action, cherry scent

813W 184g



Goo Gone

Removes chewing gum, grease, tar stickers, labels, tape residue, oil, blood, lipstick and mascara, shoe polish, crayon, bumper stickers. Citrus scent

CE605 236ml



Goof Off

Removes almost anything. Grease, adhesives, gum, latex paint, pen, markers, lipstick etc...

PF004806 133mL

PF002416 474ml

PF002617 650ml spray



Graffiti Remover

Safe on many surfaces, this product may be used on restroom walls, trucks, buses, public buildings and sidewalks. This product removes spray paints, scuff marks, marker, ink, crayon and other solvent based marks and stains.

0152300 418g Aerosol



Doodle Buster Graffiti Remover:

A Low VOC, low toxicity, biodegradable yet very powerful solution for removing paint, ink, marker, and other types of graffiti. Rinse with water. Also great on pet stains.

DB50247 1L



Graffiti remover.

Use on any hard surfaces such as glazed and unglazed tile, oil based painted surfaces, baked enamel, ceramics, etc.

DB50174 482g



Gel Vandal Mark Remover

Created by crayon, pencil, inks, spray paints, tape, waxes, and lipstick. Eliminates scuff marks from floors and walls.

880W 425g



Gas Fireplace Glass Cleaner.

Safely removes stubborn deposits from most non-porous surfaces. Seals and protects for improved appearance and easier cleaning.

KK0044 227ml



Glass Cleaner.

Ideal for cleaning glass on woodstoves, fireplace inserts or pellet stoves. Specially thickened to cling to vertical surfaces.

KK0051 473mL



Clear Flame Glass Cleaner

Easy to use trigger that effectively removes creosote, soot and grime on fireplace enclosure doors and hearth.

KK0290 650mL



Glass Cleaners



Azure Window/Glass Cleaner

Delivers exceptional performance and leaves surfaces sparkling clean without streaks. APE, VOC and Ammonia Free. Certified UL 2759

DB50202 750ml RTU
DB50201 4L



1:40



Expo Glass Cleaner

Leaves mirrors, windows and other surfaces sparkling. Fresh scent. Fast drying and non streaking

DB53701 5L



1:8



Green Earth Glass Cleaner
Streak Free Glass & Surface Cleaner

Effective cleaning of glass and other hard surfaces. Cleans and polishes without scratching, streaking, fogging or clouding. Concentrated for effective and economical use.

5354700 2L FastDraw
5350400 3.78L



1:64



Magic Glass Cleaner

A Fast, Effective, Glass Cleaner that cuts through dirt, oily film, and other deposits. Scented

DB50164 539g



Clear Image
Non-Ammoniated Glass & Surface Cleaner

This glass and surface cleaner, quickly dissolves smudges, fingerprints, bug residues and other stubborn soils. It cleans and polishes glass without streaking, fogging or clouding.

0922301 538g Aerosol



Clear Image
Non-Ammoniated Glass & Surface Cleaner

This glass and surface cleaner, quickly dissolves smudges, fingerprints, bug residues and other stubborn soils. It cleans and polishes glass without streaking, fogging or clouding.

0922302 538g Aerosol
1921200 946mL
1920400 3.78L
1925500 208L



Deep Blue - Ready To Use
Ammoniated Glass & Surface Cleaner

Not only does it quickly penetrate dust, smoke, grease and grime on all glass and window surfaces, but it is also excellent for cleaning stainless steel, Formica, plastic, porcelain and chrome.

1081200 946mL
1080400 3.78L
1085500 208L



Deep Blue Concentrate
Ammoniated Glass & Surface Cleaner

Not only does it quickly penetrate dust, smoke, grease and grime on all glass and window surfaces, but it is also excellent for cleaning stainless steel, Formica, plastic, porcelain and chrome.

1814800 908mL
1814700 2L FastDraw



1:64



Glass Cleaner

Windex powered formula saves time, effort and labour.

CB807701 765ml
CB006722 5L



Glass Cleaner

Cleans glass, windows, mirrors, windshields; enamel surfaces, chrome, tile, porcelain and other hard surfaces.

SW050CC 539g



Windshield washer fluid.

Withstands winter temperature up to -35° C.

PM-35 4L



Wood Cleaners



Furniture Polish

Cleans and shines in one effortless operation. Silicone and wax formula protects against spills and stains. CFC free. Lemon scented.

DB50168 496g



Pledge

Cleans & brightens dull furniture w/o waxy build-up. Lemon scent

94430 502g



Sprayway Furniture Polish.

An emulsion polish formulation that dusts and cleans in one easy application. Removes finger marks, smudges, grease marks and stains.

811W 20oz



Murphy's Oil Soap Wood Cleaner

Safely cleans finished wood and other household surfaces without leaving a residue. Does not contain ammonia, bleach or oils.

MUR01103 3.78L



Lemon Oil Furniture Polish

This natural lemon oil formulation cleans, polishes and protects fine furniture, woodwork, vinyl, plastic, Formica and metal. It easily removes wax build-up, fills in minor scratches and cracks and rubs out quickly to a clear, bright, hard shine.

0602300 482g Aerosol



Hand/Skin Care



Industrial Hand Soap - Powdered Hand Cleaner

Combines heavy duty abrasives with blended soap powders to give the deep cleaning power you need, when you need it.

DB52307 22 kg



GOJO Natural Orange Pumice

Hand Cleaner. Light Citrus scent

0957-08 14oz

0955-02 1gal.



GoJo Foam Hand Cleaner.

Countertop bottle, mild eco-friendly foaming hand cleaner.

5715-06 222ml



O'Keeffe's

Lip repair for Extremely Dry, Cracked Lips

K1710102 Cooling

K1700102 Original



O'Keeffe's

Skin repair for Extremely Dry, skin

K1700002 7oz



GoJo Scrubbing Wipes.

Dual textured, scrubs then wipes, has aloe, does not dry out hands. Removes grease, tar, tough dirt, adhesives, ink, paint and other tough soils. 10-1/2"x12". Orange scented.

6396-06 72/Tub



3oz



91g

O'Keeffe's

Healthy Foot Cream. For dry cracked or split feet.

K1320001 91g

K1280003 3oz



3oz



91g

O'Keeffe's

Healthy Hand Cream. For dry cracked or split hands.

K1350001 91g

K1290003 3oz



Hand Cleaners



Antiseptic Hand Soap

Suds forming, skin protecting emollient. Contains 2 antimicrobials that provide disinfectant; will not become contaminated in the dispenser; tested & proven against both Gram-positive & Gram-negative bacteria associated w/surgical and cross-infections. DIN: 00564311

DB51732 5L

Use with DB51701 & 9330 Dispenser



Tradition - Liquid Hand Cleaner

Tradition has a rich lather. Its emollient containing formula effectively cleans and leaves hands feeling smooth and soft. Certified UL 2784

DB50220 4L

Use with DB51701 & 9330 dispenser.



Corsage - Pink Hand Soap

Moisturizes and softens hands while cleaning. A pleasure to use because of the rich lather and pleasant fragrance.

DB55896 5L

Use with DB51701 & 9330 Dispenser



Tradition Plus - Foaming Hand Cleaner

Tradition Plus has a rich lather. Its emollient containing formula effectively cleans and leaves hands feeling smooth and soft, reduces usage by more than 50%. Certified UL 2784

DB50228 4L

Use with DB51700, 04 or 02 dispenser.



Ultra Orange

Using a natural citrus solvent and synthetic abrasive, it gently cleans even the most deeply embedded grime, soil and dirt. Orange scent.

DB51766 4.5L

Use with pump (DB51773) and rack (DB51777)



Polypower - Industrial Hand Cleaner

High quality, efficient detergency of cosmetic grade surfactants with the deep cleaning action of a synthetic abrasive, soft on hands.

DB51770 4.5L

Use with pump (DB51773) and rack (DB51777)



Pink Lotion Skin Cleanser
Ultra Mild Lotion Skin Cleanser

pH balanced and formulated with emollients, this ultra mild lotion skin cleanser gently moisturizes the skin while protecting skin health. Clean-rinsing and non-irritating, convenient for continual use.

1120400 3.78L

1125500 208L



Green Earth Clear Foaming Skin Cleanser
Dye Free & Fragrance Free Foaming Skin Cleanser

Cleans hands without impacting the skin, will not cause dryness or skin irritation, encourages frequent hand washing.

7150400 3.78L



Green Earth Lotion Skin Cleanser
Luxurious Lotion Skin Cleanser

Thick, rich lotion provides a pleasant hand washing experience, maintains skin health and is recommended for frequent hand washing.

7830400 3.78L



New!

Lotion Hair & Body Shampoo Clean Rinsing & Lightly Fragranced Shampoo

Appealing, non-lingering fresh fragrance leaves skin feeling clean and refreshed. Designed to leave hair and skin delicate, soft and conditioned.

7730400 3.78L



Deck Mount Dispensers

DISPENSER



401310



402243



The OneShot® dispenser

- 401310 Chrome/Black
 - 402073 Chrome
 - 402241 Low Profile Chrome/Blk
 - 402243 Low Profile Metal/Chr
- State-of-the art Smart Sensor™ patented technology to detect hands and automatically releases the perfect amount of soap.

REFILLS



- 4013111 800ml x 4
 - 4015411 1600ml x 4
- OneShot Enriched Lotion Hand Soap with Moisturizers. Enriched with Glycerin, Silk Proteins, Aloe Vera, and Vitamin E. Hypoallergenic for sensitive skin.
- 4013131 800ml x 4
 - 402363 800ml x 4
 - 402364 1600ml x 4
- OneShot Green Certified Lotion Soap. Green Seal™ certified. Hypoallergenic for sensitive skin.
- Enriched Lotion Free 'N Clean Soap. Enriched with Glycerin, Silk Proteins, Aloe Vera, and Vitamin E. Hypoallergenic for sensitive skin. Dye-free and fragrance-free. Biodegradable

DISPENSER



- DEB950
- 1L For dispensing of Debonaire Foaming Skin Cleansers. For use in office, institutional and light-use industrial washrooms.
For Refills Use DEB212 & DEB218

REFILLS



- DEB212 1Lt x 8
 - DEB218 1Lt x 8
- Debonaire Extremely mild, delicately fragranced foaming skin cleanser, instant foaming, very little water required to generate rich lather.
- Debonaire mild yet gentle antibacterial foaming skin cleanser containing Triclosan, proven broad spectrum bactericide. instant foaming, very little water required to generate rich lather.
For use with DEB950 Dispenser

DISPENSER



- Prime Source
 - 760042131 Grey wall dispenser
- Touch free foam soap dispensing system.

REFILLS



- 75004253 Lavender
 - 76004253 Antibacterial
- Foam soap, each scent comes in a 2/pk



Property Performance Centres





PRODUCTS

"Quality brands you trust, in-stock and priced right"

- Professional grade
- Full selection for one stop shopping
- Trusted quality



Dispensers & Refills

Dispensers



Compass Touch Free Foaming Dispenser
Provides reinforced training instructions for proper handwashing procedures. The LCD screen on each dispenser guides you through the 6-step process for washing hands as recommended by the Centers for Disease Control. Uses 750 ml cartridge refills.
9230000 White



Ask about our no charge dispenser program!

Refills



Green Earth Clear Foaming Skin Cleanser. Dye Free & Fragrance Free Foaming Skin Cleanser
Cleans hands without impacting the skin, will not cause dryness or skin irritation, encourages frequent hand washing.
715C307 4 x 750mL



Dispensers



Clario Dispenser
Sanitary factory sealed bags for no product contamination. Large site glass for easy products identification and maintenance. Precise portion control for cost-effective dispensing. Use 1000 ml bag refills.
9181900 Manual, White
9182000 Manual, Black



Clario Foaming Dispenser
All Clario dispensers use the same 1000 ml bags. Excellent foam quality offers a superior hand washing experience. Aesthetically pleasing design complements any facility.
9186600 Automatic, White
9182100 Manual, White



Regular Refills



Pink Lotion Skin Cleanser Ultra Mild Lotion Skin Cleanser
pH balanced and formulated with emollients, this ultra mild lotion skin cleanser gently moisturizes the skin while protecting skin health. Clean-rinsing and non-irritating, convenient for continual use.
1122900 6 x 1000mL



Alcohol Free Foaming Hand Sanitizer
Formulated with a well-recognized antimicrobial to kill germs quickly, this creamy foaming lather is enriched with air to provide thorough sanitizing while using almost 50% less liquid than traditional alcohol-based hand sanitizers.
7522907 6 x 1000mL



Lotion Hair & Body Shampoo Clean Rinsing, Lightly Fragranced Hair & Body Shampoo
Appealing, non-lingering fresh fragrance leaves skin feeling clean & refreshed. Fragrance appeals to both male & female users. Designed to leave hair and skin delicate, soft and conditioned.
7732900 6 x 1000mL



Green Earth Clear Foaming Skin Cleanser Dye Free & Fragrance Free Foaming Skin Cleanser
Cleans hands without impacting the skin, will not cause dryness or skin irritation, encourages frequent hand washing.
7152900 6 x 1000mL



Green Earth Lotion Skin Cleanser Luxurious Skin Cleanser
Thick, rich lotion provides a pleasant hand washing experience, maintains skin health and is recommended for frequent hand washing.
7832900 6 x 1000mL



Antibacterial Foaming Skin Cleanser
Aloe Enriched formula contains 0.13% benzalkonium chloride for rapid broad spectrum germ kill while still moisturizing. Mild to hands, cleans light to medium soils.
7512907 6 x 1000mL



4L Dispensers & Refills

Dispensers



Triton 4L Manual Dispenser

Triton's durable, yet practical dispenser offer heavy duty and large quantity dispensing. Factory sealed 4L bottles are easy to load, store and handle. The Triton Skin Care system is perfect for maintenance shops, factories, and facilities where a heavy duty cleaner is needed.

9182800 Black



Refills



XHD Hand Cleaner

Extra Heavy Duty Hand Cleaner With Walnut Shell

Formulated with soy and walnut shell scrubbers for extra deep cleaning to quickly cut through the heaviest greases and oils, and conditioners to prevent drying and cracking.

7933100 4 x 4L



*HD Orange Hand Cleaner
Heavy Duty Skin Cleanser With Pumice*

Formulated with natural citrus solvents to quickly cut through most greases and oils, and fine milled Aztec pumice for extra deep cleaning.

7923100 4 x 4L



*Pink Lotion Skin Cleanser
Ultra Mild Lotion Skin Cleanser*

pH balanced and formulated with emollients, this ultra mild lotion skin cleanser gently moisturizes the skin while protecting skin health. Clean-rinsing and non-irritating, convenient for continual use.

1123100 4 x 4L



2L Dispensers & Refills

Dispensers



Triton 2L Manual Dispenser

Triton's durable, yet practical dispenser offer heavy duty and large quantity dispensing. Factory sealed 2L bottles are easy to load, store and handle. The Triton Skin Care system is perfect for maintenance shops, factories, and facilities where a heavy duty cleaner is needed.

9182700 Black



Refills



Lotion Hair & Body Shampoo

Clean Rinsing, Lightly Fragranced Hair & Body Shampoo. Appealing, non-lingering fresh fragrance leaves skin feeling clean and refreshed. Fragrance appeals to both male and female users. Designed to leave hair and skin delicate, soft and conditioned.

7736200 6 x 2L



*Pink Lotion Skin Cleanser
Ultra Mild Lotion Skin Cleanser*

pH balanced and formulated with emollients, this ultra mild lotion skin cleanser gently moisturizes the skin while protecting skin health. Clean-rinsing and non-irritating, convenient for continual use.

1126200 6 x 2L



*HD Orange Hand Cleaner
Heavy Duty Skin Cleanser With Pumice*

Formulated with natural citrus solvents to quickly cut through most greases and oils, and fine milled Aztec pumice for extra deep cleaning.

7926200 6 x 2L



New!

Hand Cleaner

Formulated with soy and walnut shell scrubbers for extra deep cleaning to quickly cut through the heaviest greases and oils.

7936200 6 x 2L



Hand Cleaner Dispensers



B-822 4" Spout
B-8226 6" Spout
Top-filling design for ease of maintenance and labour savings. Vandal-resistant locking cover and free-turning spout. Corrosion-resistant.
B-822-95 1L capacity
Bottle only - replacement for both the B-822 & B-8226



B-2111

B-2111 4-3/4"W x 8-1/8"H
B-4112 7"W x 6-1/8"H

For use with *liquid hand soap*. Surface-mounted dispensers are 304 stainless steel with satin-finish. Vandal-resistant with clear refill window. 1.2L Capacity



B-4112



Open Top - Regular
 Easy to fill and is dishwasher safe. 1mL per pump
DB51701 800mL Cap.



Open Top Liquid hand Soap
 Open Top Liquid hand Soap/Lotion Dispenser. White. 1cc per pump.
9330 887mL Cap.



Foaming Dispenser



Soap Dispenser
 Uses 50% less. Only 0.25mL per pump. Fill with foaming bulk soaps only.
DB51700 800mL Cap.



Lite'n Foamy Foam Dispenser
 1000ml (34oz) reservoir, adhesive or screw mount
SCC-9756WHT WH
SCC-9757 BLK



Ask about our **no charge dispenser programs** to see if your facility qualifies.



35400353 75000140 35400352 75000144

- AMRE Supply** Touch Free Dispensers with PRIME SOURCE® Foam Handwash
- Lifetime Performance Guarantee – includes batteries
 - SANITARY SEALED™ Refills keep germs out
 - PRIME SOURCE® Foam Handwash is EcoLogo® Certified
 - Recyclable PET refill bottles
 - Available in 1200ml and 700ml sizes



Part#	Description	Color	Size	Case
35400353	AMRE Supply LTX-12 Touch Free Dispenser	Wh./Grey	1200ml	
75000149	PRIME SOURCE® Clear & Mild Foam Handwash Refill	Clear	1200ml	2
35400352	AMRE Supply LTX-7 Touch Free Dispenser	Wh./Grey	700ml	
75000144	PRIME SOURCE® Clear & Mild Foam Handwash Refill	Clear	700ml	3



35400351 75000138 35400350 75000128

- AMRE Supply** Manual Dispensers with PRIME SOURCE® Foam Handwash
- Lifetime Performance Guarantee
 - SANITARY SEALED™ Refills keep germs out
 - PRIME SOURCE® Foam Handwash is EcoLogo® Certified
 - Recyclable PET refill bottles
 - Available in 1250ml and 700ml sizes



Part#	Description	Color	Size	Case
35400351	AMRE Supply ADX-12 Manual Dispenser	Wh./Grey	1250ml	
75000138	PRIME SOURCE® Clear & Mild Foam Handwash Refill	Clear	1250ml	3
35400350	AMRE Supply ADX-7 Manual Dispenser	Wh./Grey	700ml	
75000128	PRIME SOURCE® Clear & Mild Foam Handwash Refill	Clear	700ml	4



Hand Sanitizer Dispensers



Designed to be placed in both small and high traffic spaces. Compact size and multiple mounting options for ultimate adaptability. Exposed refill for easy monitoring and servicing. Easy to install 450mL refills snap in place quickly. Smaller than a dispenser and holds more product than a bottle.

Dispenser includes screw-in and adhesive wall mounts.

Purell ES System

- 1455-D1-CAN00** Dispenser w/ 1 Refill
- 6870-06-CAN00** Refills 6/cs
- 5830-08-BLK** Black Rail Mount Bracket
- 5840-08-WHT** White Surface Mount Bracket



1455-D8-CAN00



5840-08-WHT

5830-08-BLK



PURELL® LTX™ Touch Free Dispensers with PURELL® Advanced Hand Rub

- Lifetime Performance Guarantee – includes batteries
- SANITARY SEALED™ Refills keep germs out
- PURELL® ADVANCED Hand Rub is EcoLogo® Certified
- Recyclable PET refill bottles

Available in 1200ml and 700ml sizes

Part#	Description	Color	Size	Case
354019201	PURELL® LTX-12™ Touch Free Dispenser	White	1200ml	
35401302	PURELL® Advanced Moisturizing Foam Hand Rub	Clear	1200ml	2
354013201	PURELL® LTX-7™ Touch Free Dispenser	White	700ml	
35401303	PURELL® Advanced Moisturizing Foam Hand Rub	Clear	700ml	3



PURELL LTX Floor Stand

- 2423-DS** Chrome
 - 2424-DS** White
- Does not come with DISPENSER, must be ordered separately. LTX-12 (354019201)*



Hand Sanitizers

Dispensers & Refills



2120-06 1000ml
Purell NXT Hand Sanitizer Dispenser. Good choice for space saving, requires NXT style refills



2156-01 1000ml /ea.
2156-08 1000ml 8/cs
Purell refills for NXT push dispenser models only. Kills 99.99% most common germs.



2720-12 1200ml
Purell TFX Series Touch Free Hand Sanitizer Dispenser. Requires TFX series refills. 3 C batteries included. 3yr performance guarantee.



- 20-14** 8oz
- 9659-12** 12oz
- 9674-12** 12oz w/Aloe
- 9022-10EA** 100 Wipes
Purell hand sanitizer. Available in pump bottles or handi wipes. Kills 99% of germs.



5395-02 1200ml 2/cs
Purell Advanced Moisturizing Sanitizer. Specially formulated to be mild to the skin, non-drying. For TFX Touchless dispensers.



5456-04 1200ml 4/cs
Instant Hand Sanitizer. Purell refills for TFX touchless dispenser models only. **Will not fit newer LTX models.** Kills 99.99% most common germs.



Bowl/Urinal Cleaners



Strate Flush 23% hydrochloric acid
An acid bowl cleaner designed to clean and deodorize in one operation. Does not harm plumbing and septic systems. Pungent fragrance.
DB53742 1L
DB53744 5L



Presto - 10% hydrochloric acid
An acid-based cleaner that effectively removes rust, stains, scale, and hard water deposits instantly. It cleans and disinfects in one easy step. Does not harm plumbing and septic systems. DIN: 02278898
DB55922 1L



Unbowlievable 24% hydrochloric acid
Designed for routine cleaning of ceramic toilet bowls and urinals only. Removes heavy lime, rust, scum and common organic soils. Industrial Use. Pungent scent
00026 1L



Vim
Clings to vertical surfaces and contains no harsh abrasives. Unscented
2979865 946mL



Javelin bowl cleaner w/surface protection.
Removes lime, scale, rust and hard water stains. Cleans and deodorizes
JL1030T06 946ml



Lysol Disinfectant Toilet Bowl Cleaner.
Thick formula adheres to stains and coats the bowl above and below the waterline. Angled bottle, Cleans, brightens & disinfects.
50814 Regular, 946mL
RC34062 W/Bleach, 946mL



Pull Heavy Duty 23% Acid Toilet Bowl Cleaner
23% hydrochloric acid toilet bowl cleaner was carefully formulated with added detergents, to ensure it will work quickly and remove even the most stubborn rust, scale and mineral deposits. Ideal for hard water areas. It cleans and descales in one easy step.
0711200 946mL



Kling 9% Thickened Acid Toilet Bowl Cleaner
Thickened, 9% hydrochloric acid toilet bowl cleaner contains detergents and compounds that quickly remove rust, scale, and hard water mineral deposits. Because it clings to vertical surfaces, it provides more contact time for better cleaning action than thin formulations.
0751200 946mL



Stix Toilet Bowl, Porcelain, & Shower Tile Cleaner
Phosphoric acid, detergents, wetting agents unite to quickly remove hard water mineral deposits, scale, rust, soap scum and filth from restroom surfaces.
0761200 946mL



BioActive Solutions Push Drain Maintainer, Floor Cleaner, & Spotter
Stable liquid suspension of cultured bacteria and malodor counteractants capable of digesting complex proteins, starches, fats, oils and greases, paper, vegetable gums, hair and other organic waste.
1331200 946mL
1334700 2L FastDraw
1330400 3.78L
1330500 18.9L
1335500 208L

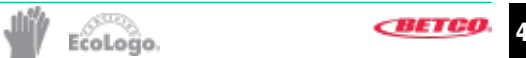

Washroom Cleaners



Bio-Bac II - Bio-Based Cleaner/Deodorizer
A blend of surfactant and bio-cleaning agents (bacillus), revolutionary cleaning solution. Removes organic soils in a safe and efficient way. This "people friendly" bacteria keeps working long after the initial application. Certified UL 2792. **Good for pet odor.**

DB53762 4L

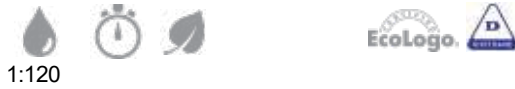

1:120



Oxy-Q Hydrogen Peroxide Based Disinfectant
Utilizes the power of hydrogen peroxide to create a non-toxic, complete cleaning solution. Dilute it according to your application — one product does it all.

DB52880 4L



1:256



Polar - Bathroom Cleaner
A multipurpose cleaner that powerfully removes dirt, soap scum, hard water build up, and mineral stains from a multitude of surfaces. Its non-acidic formula eliminates the risk of damage to sensitive materials. Certified UL 2759

DB50216 1L
DB50218 4L



Blu-Lite & Foaming Blu-Lite Plus
An effective phosphate and APE free cleaner, disinfectant, descalant and deodorizer for washrooms. Fresh fragrance.

DB53747 1L
DB53749 5L
DB53757 1L (Foam)
DB53755 4L (Foam)



1:40



Aqua Scrub
This one-step cleaner and polisher has efficient cleaning abilities and a fresh lemon mint scent. Its high viscosity allows it to cling to surfaces to give optimum contact time. An effective acid replacement cleaner that provides a deep cleaning for multiple surfaces.

DB53732 1L
DB53734 5L



Nu-Life - Effectively removes salt deposits from most surfaces

Soap Film Remover penetrates and dissolves hard water soap scum and deposits for easy and effortless removal. Neutralizes ice melter salts. Lemon Mint scent

DB51272 5L



1:80



Pumie Porcelain and Tile Cleaner.

Cleans where chemicals fail. Removes stubborn lime, rust and drain snake marks from porcelain & ceramic, Plastic handle style for hard to reach spots.

JAN12 Pumie Stick
JAN6 Pumie w/Handle

Pumie



T'N'T - Tub & Tile Cleaner
Clings to Vertical Surfaces Free Rinsing Controlled Suds. For Industrial Use.

4357 1L



BTB Instant Mildew Stain Remover
Works as a mildew stain remover to quickly clean and whiten even the most difficult stains. Formulated with an odor counteractant and chlorine stabilizer.

3211200 946mL



Green Earth Restroom Cleaner Concentrated Non-Corrosive Heavy Duty Restroom Cleaner

Heavy duty cleaner that is chemically designed to remove heavy soap scum, body and tanning oils, mineral deposits and other soils found in all areas of the restroom. Effective on tile and grout surfaces, countertops, sinks and toilets.

5484700 2L FastDraw
5480400 3.78L



1:64



Washroom Cleaners



Best Bet
Liquid Abrasive Creme Cleanser
 Liquid Creme cleanser quickly removes embedded rust, soap scum, stains, grease, oxidation, hard water minerals and filth from a variety of surfaces.
0771200 946mL



AF79
Acid Free Bathroom Cleaner & Disinfectant
 Excellent multi-purpose germicidal detergent that disinfects, cleans, & deodorizes in one easy step. Offers excellent cleaning performance on a wide variety of restroom environmental surfaces.
0791207 946mL



Tile Clean
Deep Cleansing Hard Tile Cleaner
 Fast acting foaming cleaner for all types of hard tile surfaces and grout
1190400 3.78L



1:43



Green Earth Bathroom Cleaner
Non-Corrosive Heavy Duty Restroom Cleaner
 Restroom Cleaner for cleaning and removing difficult hard water stains and soap scum on sinks, counters fixtures, tubs, floors, walls, glazed tile, and porcelain.
3091200 946mL



Sure Bet
Foaming Shower Restroom Cleaner
 Sure Bet disinfects, cleans, and deodorizes in one labor-saving step. This formulation penetrates and dissolves soap scum, ground in dirt and grime, mineral deposits, rust, lime soap build up, hard water satins, and kills household germs.
3243200 946mL



Sure Bet II
One-Step Acid Cleaner, Disinfectant, & Deodorizer
 Disinfects, cleans, & deodorizes in one labor-saving step. Formulation penetrates & dissolves soap scum, ground in dirt and grime, mineral deposits, rust, lime soap build up, hard water satins, & kills germs.
3141207 9.46mL
3144707 2L FastDraw
3140407 3.78L
3140507 18.9L
3145507 208L



1:32



Tilix Bathroom Cleaner.
 Safe for most bathroom surfaces, dissolves soap scum on contact. Bleach-free formula.
CL01152 946mL



Tilix Mold & Mildew remover.
 Bleach powered to remove stains and disinfect.
12438 946ml



Lime Licker
 Remove scale and/or oxidation build-up from a variety of surfaces. Fast Acting. Fruity scent.
00027 1L



Javelin Lime and Scale Remover
 Dissolves hard water deposits, soap scum, rust stains and urine stains. Low odour & low toxicity. Safe on most metals including stainless steel, brass, aluminium, steel and more.
JL1040 946ml



Fibreglass Cleaner
 Gel-Gloss tub and shower, cleans, seals and shines.
GG-1B 437ml (Liquid)
3131 437ml (Aerosol)



Waterless Urinal Odour Barrier Fluid
 Oil-based liquid designed to float on top of fluid in a water free urinal cartridge, a flushing urinal well or in a floor drain. Ocean breeze scent.
2917000 857ml



Drain Openers



Javelin Drain Deodorant

Instantly dissolves odour in garbage disposals, waste and overflows, sinks and floor drains. Lemon scent.

JA1000 510g



Urinal Drain Cleaner

Powerful, yet safe - dissolves tough uric acid salt buildup, mineral scale and rust deposits in drain lines. Restores full flow and prevents restrictions from forming. Regular use provides protective coating and prevents future buildup

JL1010 946ml



Non Acid Drain Cleaner

Maximum strength - strongest opener on the market today. Fast acting. Penetrates through standing water. Safe on all plumbing materials including cast iron, PVC, ABS, copper and steel. Uses sodium hydroxide. Lemon scent

JL1000 946ml



Nitro

Powerful and fast acting solution for drainage issues as it clears the toughest clogs. Safe for all septic systems and pipes, including PVC, plastic and old pipes.

DB50176 1L



Powerhouse

Dissolves blockages caused by organic matter & opens drain lines on contact.

00023 1L



Pressure Plumber Plunger

Used in toilets, shower stalls, floor drains and garbage disposals. PPC-300 Sold Separately

CAK-1



Pressure Plumber

Used on Single Sinks, Double sinks and Bathtubs. Compressed air shoots any clogs with pressure. 24 Applications

PPC-300



Pro GRADE



Urinal Supplies



Deodorant Blocks/Non Para-Benzene.

Remove hard water scale, uric salt and the congealed solids that cause blockages and odours. Woody Spice scent.

DB53412 48/pk



Urinal Deodorant Block.

2-1/2" Round Urinal Deodorant Block. 3oz (85g) Cherry fragrance.

06311W 12/pk

06931 each



Urinal Screen

Para products are activated by air. Use in urinals with standing water.

Non-staining. Deodorizes continuously for up to 30 days. Cherry scent

01901 each



Flat Urinal Screen

Urinal Screen with Odor Counteractant

Urinal screen combines the action of deodorizers and odor counteractant to control the toughest odors in a restroom. A specially designed screen protects the drain against debris and reduces splash back. Each.

2517200



Urinal Screens

Rubber screen, blocks waste build-up. Sold individually.

HC0001CH Cherry

HC0001BG Bubble Gum



WAVE CUCUMBERMELON
WAVE KIWI/GFRUIT
WAVE FABULOUS
WAVE SPICEDAPPLE
WAVE HERBALMINT
WAVE MANGO

WAVE WINTERGREEN
WAVE OCEANMIST
WAVE COTTONBLOSSOM
WAVE GUAVA/PAPPLE
WAVE CITRUS

99% Anti-Splash Design
combined with Deodorizer!

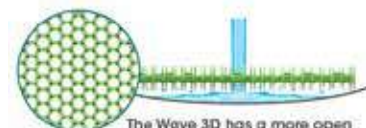

The Wave 3D has a more open design, increased height, and thus does not splash.

Wave 3D Urinal Screens. Combines 30 day urinal air freshener/deodorizer with the absolute splash elimination. Also includes easy reminder system so you know when to change out. 2/pk



Odour Care

AquaScent

Aquascent's advanced technology utilizes premium natural fragrance oils, and unprecedented residual performance to give your "clean image" a refreshing boost. Eliminate chemical smells commonly found in cleaning solutions. It can be used both as an air freshener or additive in your cleaning solution.

DB51144 5L



1:160



Cancel

A liquid, multi-purpose, water soluble malodour counteractant that effectively neutralizes a wide range of unpleasant odours. It can be used both as an air freshener or additive in your cleaning solution.

DB55100 5L



1:80



Disappear

Counteracts & eliminates unpleasant odours. Ultra powerful formula makes any undesirable odour disappear quickly without using or leaving an overpowering cover-up (masking) perfume. Used as an air freshener or additive in your cleaning solution.

DB51010 750ml RTU

DB51014 5L



1:160



Stink Relief

The ultimate in odour control & freshness. This natural enzyme-based formula destroys odour at its source while being safe to use around people and animals, is non-toxic, non-flammable, hypo-allergenic and biodegradable.

DB51146 5L



Friendly Air

An advanced concept in malodour removal that eliminates disagreeable and lingering odours. Safe, non-toxic and nonflammable, it will not stain any material unaffected by plain water.

DB51017 5L



BAN-O

Eliminates unpleasant odours at the source. Excellent deodorant for use in washrooms, garbage cans, refuse disposal bins, lockers, changing rooms, and anywhere offensive odours exist.

AVJ80 4L



1:80



Lemon Zest

BestScent Air Freshener immediately defeats lingering odours, freshening the treated area with a pleasant aroma.

2331200 946mL RTU

2264700 2L FastDraw

2260400 3.78L

2265500 208L



1:256



Lavender Mist

BestScent Air Freshener immediately defeats lingering odours, freshening the treated area with a pleasant aroma.

13331200 946mL RTU

13344700 2L FastDraw

13340400 3.78L



1:256



Ocean Breeze

BestScent Air Freshener immediately defeats lingering odours, freshening the treated area with a pleasant aroma.

2351200 946mL RTU

2314700 2L FastDraw

2310400 3.78L

2315500 208L



1:256



Mountain Meadow

SenTec traps and removes odours from the air, significantly reducing the malodor present in the room.

40257000 946mL RTU

4125B200 2L FastDraw

41250400 3.78L



1:256



Pure Linen

SenTec traps and removes odours from the air, significantly reducing the malodor present in the room.

40307000 946mL RTU

4130B200 2L FastDraw

41300400 3.78L



1:256





Febreze car vent clips.

Air Freshener unique scent release technology to continuously eliminate odors.
81113 Linen & Sky



What is the difference between an **air freshener, odour counteractant and deodorizer?**

Deodorizer / Air Freshener - Mask odours but does not cover the odour permanently — it simply adds a good odour to a bad odour or can give a room a fresh scent.

Odour Counteractant / Eliminator - They neutralize the malodour by breaking down its molecules in the air. An air freshener with odour counteracts is the best solution for a facility with offensive malodours such as smoke and rotting food.

Enzyme Based - Attack the contamination, creating enzymes that break down odour-causing matter. For bio-based odour such as urine. Humid conditions or rewetting the surface can reactivate the odours. The great benefit of enzyme based products is that they will keep working even after the initial application.

New!

Refresh
your car!



4 Per Pack

- E300888003** New Car/Cool Breeze
- E300888900** Summer Breeze/Alpine Meadow
- E300889100** Fresh Strawberry/Cool Lemonade
- E300908400** Lighting Bolt/Ice Storm

Refresh Your Car Vent Sticks

Provide an affordable and easy-to-use approach to adding incomparable scents to your car. Dual scents. Simply insert them in your vent and enjoy the fragrance.

2 Per Pack

- E301336700** Fresh Linen
- E300868404** Hawaiian Sunrise
- E300868002** Very Cherry
- E300868203** New Car

Refresh Your Car Mini Diffusers

Once attached to your vent, Refresh Your Car Mini Diffusers allow you to adjust the fragrance level of your car. The smaller size allows you to put them in more areas of your car, without blocking the flow of air.

New!



OTTO Fresh Vehicle Air Freshener.

Just open and place it under your seat. No messy oils, gels or liquids.

OTTO-16 Clean Breeze



Bestscent Smoke & Odour Eliminator

Water based aerosol with Neutrabond malodor counteractant technology and specially blended fragrances.

0622300 454g Aerosol



New!



Sentec Malodour Eliminator Aerosol

Don't just cover up odours, completely eliminate them. Scientifically built & designed to leave a positive impact on your facility & occupants is like no other in the market today.

- 42252300** Mountain Meadow
- 42302300** Pure Linen



Bestscent Air Freshening Aerosol

Water based aerosol with Neutrabond malodor counteractant technology and specially blended fragrances. 454g.

- 0242300** Ocean Breeze
- 0362300** Lavender Mist





Citrus Air
Multi-purpose product!
Aerosol Room Air deodorizer unique citrus fragrance, neutralizes odours on contact. Citrus qualities also act as an amazing cleaner as well as adhesive remover etc...!
DB50175 369g



Disinfectant Deodorant
A convenient way to disinfect and deodorize surfaces. Ideal for disinfection of hard non-porous surfaces. Floral scent
DB50162 425g



Odour Neutralizer!
Ozium Industrial/Institutional strength sanitizer neutralizes odours. Fits most dispenser systems or use as hand held. Simply one of the worlds best!
OZIUMOC-19 198.5g



Citrus Burst Air Freshener
Institutional, Commercial & Industrial use. Eliminates most objectionable odours such as onion, garlic and smoke. Citrus scent
244W 425g



Dry Air Freshener and deodorizer.
Attacks odours trapped in carpeting, upholstery, and draperies without staining. Perfect for bathrooms, smoke areas, offices etc...
165W 284g Tropical Fruit
161W 284g Apple Blossom



Attack - Odour Counteractant & Air Freshener.
Eliminates tough odors in the air and combats odors trapped in carpeting, upholstery, draperies, fabric and clothing. Orange scent.
586W 369g



Febreze Fabric Refresher.
Spray on carpets, curtains, and other hard-to-wash fabrics to replace odors with long-lasting freshness. Spring & Renewal scent.
18930 800mL



Febreze Institutional - Ready to use
Spray directly on fabrics until slightly damp. As it dries, odours disappear. Safe for virtually all fabrics. Available in ready to use and concentrate formulas. Fresh scent.
03259 945ml
33032 3.78L



Febreze Air Effects
Air Freshener sweeps away stifling odours using our patented technology & leaves only a clean, refreshing scent. Tough bathroom, cooking, smoke odour and more. 275g spray can
PG96257 Heavy Duty Crisp Clean
07100 Linen & Sky



Febreze Noticeables Alternating Scented Oil Warmer
Air Freshener Fragrances sold separately. Plug in style.
22714 1/pk



Febreze Noticeables Dual refills.
Air Freshener keeps rooms smelling fresh and clean for days. Dual refills alternate between complimentary scents.
45540 Linen & Sky
45541 Meadows & Rain
Fits PG22714 dispenser.



Don't forget to login to see wholesale pricing

www.amresupply.com

DISPENSER

Aerosol Dispensers
Spray timer adjusts to release in intervals. Polypropylene construction. 24-hour/day (light sensing) modes of operation. Wall mount is easy to refill. Longer-lasting battery life
7531L Stratus 3 dispenser
5, 10, 15, 20 min. intervals

Best Sellers



REFILLS

Covers up to 6000 ft.

- 7931** Citrus Grove
 - 7906** Cinnamon Spice
 - 7915** Very Vanilla
 - 7917** Mango Madness
 - 7918** Fresh Linen
 - 7908** Tropical Tradewinds
 - 7909** Baby Powder
 - 7930** Orchid Spice
 - 7932** Fresh Garden
 - 7929** Fruit Basket
 - SW114W** Rain Forest (Dura Plus)
- Air Freshener provides up to 3400 metered sprays of deodorizing fragrances. 7oz.



FREE! Ask about our free dispenser program!
Give us a call **1.800.661.9891**

Janitorial



Fuel Cell Technology covers upto 6,000sqft

DISPENSER

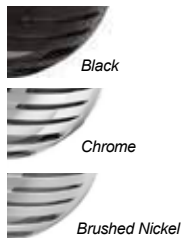

- 1957531 Black
- 1957532 White
- 1957533 Chrome
- 1972664 Brushed Nickel

Rubbermaid TCell™ 2.0
Air Freshener Battery free silent passive system, versatile mounting, 30 or 45 day dispensing options, spill resistant, sleek and modern, cost effective, 4.09"D x 2.36"H



REFILLS

- | Part # | Scent |
|---------|-----------------|
| 1957522 | Citrus Zest |
| 1957521 | Spring Blossoms |
| 1957523 | Mango Blast |
| 1957524 | Cucumber Melon |
| 1957525 | Marine Fresh |
| 1957526 | Lavender Mint |
| 1957263 | Pure |

Air Freshener Refills are sold per each, but come 6 per case



NON - Metered



DISPENSER



1793547 1793548

TCell™ Air Freshener Dispenser
Delivering a precise dose of pure designer fragrance and odour neutralizer that remains constant for 60 to 90 days *without the use of batteries.*

- 1793546 Black
- 1793547 White
- 1793548 Chrome

REFILLS

Lasts 60-90 Days!



- | Part# | Scent |
|---------|------------------|
| 402498 | Pure Neutralizer |
| 402110 | Wakening Spring |
| 402111 | Polar Mist |
| 1836256 | Purifying Spa |
| 402187 | Crystal Breeze |
| 402470 | Cucumber Melon |
| 1836258 | Energizing Spa |
| 1836257 | Relaxing Spa |
| 402112 | Blue Splash |
| 402369 | Mango Blossom |
| 402473 | Summer Sorbet |
| 402472 | Tropical Sunrise |

The TCell™ Air Freshener refills contain Micro-trans®, a true odour neutralizer. TC® refills contain only the highest quality essential oils. Range of fragrances, mild to intense for a clean, fresh scent.



NON-Metered

For large spaces that need a simple odour solution.



DISPENSER

Eco Air 2.0 Passive Freshener System
Air Freshener Lasts 30 days, Outperforms gels, wicks, and aerosols, no batteries or fans.

EACAB White Cabinet
Use in restrooms, conference rooms, entry ways, lobbies, trash rooms etc. 100% recyclable.



Fragrance	Color
Herbal Mint	Green
Kiwi Grapefruit	Red
Fabulous	Purple
Mango	Orange
Citrus	Yellow
Spiced Apple	Pink
Cotton Blossom	Blue
Cucumber Melon	Light Green

REFILLS

- EA36CB Cotton Blossom
- EA36CM Cucumber Melon
- EA36CT Citrus
- EA36HM Herbal Mint
- EA36KG Kiwi Grapefruit
- EA36MG Mango
- EA36SA Spiced Apple
- EA36TRP Tropical

Air Freshener Refill fits in its own dispenser, and many others such as T-Cell. 6/case



Spray Heads & Bottles



3557 8"
Multi-purpose trigger
Red/white Multi Purpose
Sprayer



3558B 9-1/4"
High Output & Leakproof
Blue/white Large Capacity
Trigger Sprayer



DB63927 9"
Foaming trigger white
Multi Purpose Sprayer



HC0025 24OZ
HC0033 32OZ
Bottle round w/WHMIS



KA9 4L
DB51773 5L
Bottle Pumps

24 HR. 
Order by **4pm** for **24-48hr shipping**
to almost anywhere in Canada!

Eco Easy Fill



EASY AS 1-2-3!

Easy to use and set up. Just insert the straw into the container, screw on the Eco Easy Fill dispenser then connect to a water source and your portable dilution system is ready to use!



SAFE

Safety through the integrity of the system in preventing leakage and exposure. Designed to simplify work and eliminate spills that can be dangerous to the user.



ECONOMICAL

Eliminates the risk of spills which prevents chemical loss and promotes a cost effective use of the chemical. The accuracy of the dilution in precise and foolproof dilution of chemical concentrates eliminates waste.



ENVIRONMENTAL STEWARDSHIP

Designed to prevent accidental discharge of concentrates.



	White DB51070	Black DB51072	Yellow DB51091	Blue DB51092	Green DB51093	Grey DB51069
Dilution	1:10	1:20	1:40	1:80	1:120	1:256
Dustbane Products	Azure, etc.	Oxy-Q Bio-Bac II, Restore, Time-Out Plus, etc.	Oxy D.S.T, Bio Bac II, Emerald, etc.	Quat Plus, Vanguard Disappear, etc.	Excelsior, Eco-Expert, Emerald, etc.	Vanguard, Excelsior, etc.

Ask us about the Dustbane line-up
of Modular Super Concentrates.
A great supporting chemical
solution for proportioning systems!



Proportion / Dilution Control Systems

HSP7983 3+1
HSP7984 2+2

Dustbane Proportioning System
Flexible and easy to install systems that consistently dispense precise amounts of chemicals. Ensures optimal cleaning performance.
Can be configured with 2x1GPM+2x4GPM or 3x1GPM+1x4GPM.
On-site consultation and training available.



20011TS 1 gal.
20012TS 2 gal.
20013TS 3 gal.
Janitorial/Sanitation sprayers, ideal applicator for cleaners, degreasers and disinfectants



BETCO® Chemical Management System
FASTDRAW

Reduce your Carbon Footprint!
 Decrease chemicals and plastic in the waste stream.



Innovative



Simple



Versatile



Fastdraw Freedom Portable Dispensing System

One portable dispensing system does it all. Fill bottles, buckets, automatic scrubbers and foaming spray applications from small convenient package. Simply hook up the hose and dial your application.

9129000



Fastdraw Chemical Management Dispenser System

Small and compact and the simple design makes it extremely easy to change products. Dispenser fits virtually anywhere. With FASTDRAW® 1 you will always get the right solution.

9104300 1 Product



Fastdraw PRO Chemical Management Dispenser System

Most durable, versatile & simple 4 bay locking chemical management system on the market. Durable exterior, robust 3 point lock for each door and hinges that with stand the toughest cleaning environment. Dispenser is designed to dispense to bottles or buckets from each bay and can be mounted in a corner or flat walls. Filling quart bottles has never been more simple, slide the fill tube into the bottle and push up.

9159900 4 Product



Fastdraw Product Rack

Holds up to four 2L bottles of cleaner to be used with the system. Incl. hardware, lock and spare keys.

9104400

bottles not included



Over 40 FastDraw Selections Available!

Ask Amre about creating a Custom FastDraw program!



Latex

Economical/Quality Latex

Ansell

- 198-M M
- 198-L L
- 198-XL XL

17 mil economy natural latex gloves. Snag, puncture, abrasion and cut resistant. Cotton flock lining. 12"/bag



Handsoff® Reusable Flock-Lined



- ALMSG SM
- 3333-M M
- 3333-L L
- 3333-XL XL

Natural 15 mil rubber latex is resistant to a wide variety of chemicals, oils and solvents. Cotton flock lining. 12" straight cuff. *Not for medical use, sold pair/ea.*



Latex - Rubber

Natural Rubber Latex

Ansell

- 208-M M
- 208-L L
- 208-XL XL

29 mil palm is 50% thicker than standard gloves. Increased strength and puncture/cut protection. 100% cotton flock lining. 12"/bag



Natural Rubber Latex

- 459B-M M
- 459B-L L
- 459B-XL XL

Natural 30 mil rubber latex is resistant to a wide variety of chemicals, oils and solvents. 12" rolled cuff.



Caution: Latex gloves contain natural rubber latex, which may cause allergic reactions in some individuals.

Looking for a specific glove? We have hundreds of styles to choose from, give us a call.

Disposable

Blue Rubber Latex Disposable



- Grease Monkey
- 5553PF-M M
- 5553PF-L L
- 5553PF-XL XL

15 mil heavyweight natural rubber latex. Powder free. 11" rolled cuff. Non-sterile. 50 gloves/box.



Conform Rubber Latex Disposable



- 6666-S S
- 6666-M M
- 6666-L L
- 6666-XL XL

5 mil natural rubber latex protects from a variety of chemicals. Powder free. Rolled cuff. CFIA approved, non-sterile. 100 gloves/box.



Disposable

Nitrile Powder-Free



- 8888PF-S S
- 8888PF-M M
- 8888PF-L L
- 8888PF-XL XL

5 mil blue nitrile offers superior strength with excellent resistance to punctures and tears, chemically resistant to oils, solvents and grease. Powder free. Rolled cuff. CFIA approved, non-sterile. 100 gloves/box.



Disposable

Handsoff® Vinyl Disposable



- PRIME SOURCE
- Lightly Powdered
- 75006120 S
- 75006130 M
- 75006140 L
- 75006150 XL
- Powder-Free
- 75006230 M
- 75006240 L

High quality 5 mil gloves. Increased sensitivity and stretch-to-fit without restriction of circulation. Rolled cuff. 100 gloves/box.



Nitrile

Nitrile 5 mil thickness



- Grease Monkey
- 5554PF-M M
- 5554PF-L L
- 5554PF-XL XL

5 mil powder free nitrile. Exceptionally durable with superior abrasion and puncture resistance, works well in oil slick applications. 9.5" rolled cuff. CFIA approved. 100 gloves/box.



Nitrile 8 mil thickness



- Grease Monkey
- 5555PF-M M
- 5555PF-L L
- 5555PF-XL XL
- 5555PF-XXL XXL

8 mil heavyweight, powder free nitrile. Exceptionally durable with superior abrasion and puncture resistance. 11" rolled cuff. CFIA approved. 50 gloves/box.



Nitrile powder free



- 4444PF-S S
- 4444PF-M M
- 4444PF-L L
- 4444PF-XL XL

5 mil teal nitrile. Superior strength with excellent resistance to punctures and tears, chemically resistant to oils, solvents and grease. Powder free. Rolled cuff. CFIA approved, non-sterile. 100 gloves/box.



Nitrile

Ansell

- 37175-M M
- 37175-L L
- 37175-XL XL

Sol-Vex Nitrile Gloves offer superior snag, puncture and abrasion protection. Suitable for heavy-duty cleaning applications. FDA compliant. 12 gloves/bag.



Polyethylene



- LDPE5S S
- LDPE5M M
- LDPE5L L

Watson Food Preparation Disposable Polyethylene Gloves. 1.5 mil polyethylene for single use hand protection when handling food. Powder free. 500 gloves/box.



Toilet Brushes

2335
Basic Bowl Brush. Stiff bristles and curved handle for easy cleaning

823
Round Bowl Brush
Medium-course bristles with round head

163
Soft Grip Round Bowl Brush. Features under the rim scrubber

3000
Toilet Bowl Swab
Resists acids and alkalinity. Soft bristles won't scratch porcelain.

3452
Brush & Caddy Set

Scrub Brushes

4100G 9"
Stiff short handle gong brush

838 20"
Medium/Stiff Utility Scrub Brush. Chemical and solvent resistant bristles

4005 6"
Iron Scrub Brush. Plastic block, easy grip design

4022
Soft Grip Hand & Nail Scrub Brush

150AG
Stiff Union Scrub Brush
Aggressive natural union fibre for scrubbing tough to clean areas.

Deck/Wall Brushes

4023G 9"
Tile & Grout Brush.
Soft grip handle with molded in scraper.

F2310 10"
Pot & Pan Scrub Brush.

690210A 10"
Deck brush with handle, assembled.

53561912A 12"
Deck brush with handle, assembled.

667 14"
Counter Duster, plastic block, blue poly fiber

Counter Brushes

Window Squeegees

New!

46610AG 10"
46614AG 14"
46618AG 18"
Stainless Steel Handle w/ Channel. High quality window cleaning tool designed for commercial use.

New!

46510AG 10"
46514AG 14"
T-Bar w/ Scrubber. Microfibre pile maximizes the scrubber's surface area, easily trapping dust and debris.

New!

46110AG 10"
46114AG 14"
46118AG 18"
Squeegee Channel w/ Rubber

New!

46100AG
Squeegee Handle

New!

37610AG 10"
37010AG 10" Refill
37614AG 14"
37014AG 14" Refill
37618AG 18"
37018AG 18" Refill
Golden Glove T-Bars & Refills
Constructed of high-impact plastic with special water-holding reservoirs to keep the scrubber wet longer.

New!

46001AG
Includes 3x10' extension pole, 10" and 14" scrubber refill, 10" and 14" scrubber t-bar, 10", 14", and 18" squeegee channel, and squeegee handle.

New!

3 Piece
46710AG 10'

4 Piece
46716AG 16'
Extension Pole. Constructed of light-weight fluted aluminum to reduce user fatigue.

Erasers

New!



107AG 12/pkg

Eraser Sponges. No detergent or chemicals needed. Just use dampen sponge with water to erase.



01495 4/pkg

Mr. Clean Magic eraser cleans tough dirt, lifting it away from walls, floors, and more.



PG82047 4/pk

Mr. Clean Magic Eraser Kitchen Scrubber. Removes 2x more greasy kitchen mess per swipe with the grease fighting power of dawn.



Steel Wool



KA50SS 12/pkg

Stainless Steel Scouring Sponges. Aggressive scourer will not rust and is made from one continuous piece of stainless steel – no loose ends to break off.



- NA121158 #3, Coarse
 - NA121157 #2, Medium/Coarse
 - NA121156 #1, Medium (Household)
 - NA121155 #0, Fine (Scouring)
 - NA121154 #00, Very Fine (Metal Polish)
- Steel Wool, 12/pkg.



- CL01346 10/Pkg.
 - 92162 50/Pkg.
- SOS Steel Wool Soap Pads

Scrubbers/Sponges

3M

3M2000-1 1/pkg.
3M2000 20/pkg.

3M Pads Scotch-Brite Power Pad 2000. Scours up to four times faster than conventional scouring products. 5.5" x 4"



3M

3M3000-1 1/pkg.
3M3000 20/pkg.

3M Pads Scotch-Brite Power Pad 3000. Two cleaning tools in one. Scotch-Brite Power pad combined with a sponge. 4.5" x 3"



7002G 1/pkg

Heavy Duty Scrub Sponge Dual action sponge, works well on walls, tables, fixtures, countertops and floors. 6" x 4"



3M

3M88 10/pkg.

3M Pads Scotch Brite Heavy Duty Pot & Pan. Removes baked-on food from pots and pans. Use in place of metal sponges. 5" x 3.5"



- 3M86 Heavy Duty, 12/pkg
 - JR8669 Medium Duty, 10/pkg
- Scouring and scrubbing pads. 6" x 9"



4A

Medium Aqua Sponge. Good choice on soft surfaces that might scratch such as laminates. 6" x 3.5"



122230 2/pkg.

Glass & Ceramic Scrunge. Features two sides, one rough to eliminate burnt-in stains and greasy dirt film, and a soft side to remove grease, loose dirt particles and to leave a streak-free polish.



New!



68250 2/pkg

Handyscrub Soft Scrubber. Silver technology provides antibacterial protection against cross-contamination.



TCTM10



TCEMM1

TCTM10 Microfiber

TCEMM1 Microfiber

Microfiber washing mitt 7" X 10" with elastic wrist. Attracts and holds dust and dirt.



3600G



14508

Wall Washing

3600G 9" Flat "Sticky" Holder only. Swivel head with locking collar adjusts ensuring a snug fit with most handles. Will also hold most 10"x5" utility pads.
14508 9" Wall Mop. Cotton wall washer mop, with velcro attachment.



Pads

Wall Washing utility pads.

- 690AG White, Light
 - 691AG Blue, Medium Duty
 - 692AG Brown Medium/Stiff Duty
 - 693AG Black, Coarse
- 10" x 5"

Looking for **Hand Dryer Parts?**
Stop in or give us a call! **We stock all Brands.**





603 Green - Multi Purpose
604 Pink - Washroom
605 Blue - Glass
Microfibre hand cloths pick up twice the bacteria and dirt as common hand wipes. 5/pk



3131B Blue
3131P Pink
3131Y Yellow
3131G Green
Microfibre cloths Perfect for all your commercial cleaning needs.



13-536-10 10 lbs pack
Medium duty service and shop rags. Coloured, similar to polo cotton t-shirt material, low cost, no lint.



BARWIPES
Bar Towels, Terri-Cloth cotton wipes. 17.5" x 14.5", 12/pk



Looking for a
Special Product or Brand Name?
 Give us a call!
 We can help you out.



34015P 180/box
WYPALL X60 Wipes. Great general purpose wiper reinforced for extra scrubbing power. 17" x 12.5"



05843EA 1 Roll
05843 24/case
WYPALL L30 Wipes, similar to shop wipes, suitable for all kinds of jobs, 70 sheets per roll



450360EA 1 Roll
450360 30/case
Tork Advanced ShopMax Shop Towel. Power through oil, grease and solvents. Thick construction, highly absorbent and low lint. 60 sheets/roll.

Caddy



3010
 Plastic housekeeping caddy



315488BLA
 Rubbermaid housekeeping caddy

Dusters



4025 28"
 Lambswool Duster



4026 30-60"
 Lambswool Duster



TCEWD2
RCR Topsi Microfiber
 5 Fingered Duster. 3-3/4" x 3-3/4" x 16-7/8". Attracts and holds dust and dirt



TCEBD1
Microfiber Blind Duster. Clean up to 3 blind slats at once with no chemicals needed. The machine washable microfibre cloth attracts and holds dust and dirt. 3" x 1" x 9".



TCED1
Compact Microfiber Duster with Foldable Handle. Machine washable. Attracts and holds dust and dirt for a chemical free clean.



Swiffer - Duster



11804 Starter Kit
21459 10/pk Refills only
Swiffer Duster Kit. Picks up dust and locks it away with thousands of flexible fluffy fibres. Includes 1 handle & 5 refills



92927 Starter Kit
PG21620 6/pk Refills only
Swiffer 360 duster kit. Designed to clean dirt in grooves and crevices. 50% more fibers than regular Swiffer dusters. Includes 1 handle & 3 refills



PG44750
Swiffer 360 Duster Extender Kit. Extends up to three feet with an extendable duster handle that pivots and locks into four different positions. Includes 1 handle & 3 refills
 Uses PG21620 Refills



Indoor Broom



3032 9"
Lobby Dust Broom, poly
bristles won't stain
3/4" x 34" handle



454 9"
Angle Broom, plastic cap, ideal
housekeeping broom.
48" Metal Handle



452 10"
Neat N'Easy Magnetic Broom
3" fibers, static allows for fine
dust pick-up.
48" Metal Handle



4011G 12"
Angle Broom with mono block,
whisk feature.
7/8" x 48" metal handle



453 12"
Magnetic Broom, 3" split-tip
bristles for fine dust & debris,
48" metal handle



458-BS 13"
Big Sweep angle broom.
48" steel handle



4006 15"
Jumbo Commercial
angle broom.
48" metal handle

**Janitorial experts
available for onsite
consultations.
Inquire today!
Available in most
major cities**

Corn Broom



760 3 string
Lobby Corn Broom
3/4" x 30" wood handle



1037 1 Wire/3 String
A-Frame Heavy Corn Broom
w/fiber center.
1-1/8" x 48" wood handle



4002G 1 Wire/3 String
Heavy Duty Corn Broom, 100%
corn fibers.
1-1/8" x 48" wood handle



4001G 1 Wire/3 String
Industrial Corn Broom, 100%
corn fibers.
1-1/8" x 48" wood handle

Push Broom

New!



For Fine Debris - Indoor

4061 18"
4062 24"
4053 18" Head Only
4054G 24" Head Only
Soft bristles ideal for sweeping smooth
floors and dry debris. Includes 60" wood
handle & steel brace

New!



For Medium Debris - Indoor/Outdoor

4063G 18"
4064G 24"
4055G 18" Head Only
4056G 24" Head Only
Medium bristles ideal for general sweep-
ing. Includes 60" wood handle & steel
brace

New!



For Heavy Debris - Outdoor

4065G 18"
4066G 24"
4057F 18" Head Only
4058G 24" Head Only
Rough bristles ideal for mud, leaves,
rocks, landscaping. Includes 60" wood
handle & steel brace



**Flip to page 61 for
replacement broom
and mop handles!**



87-1
Broom Brace, powder-coated metal, fits
18" to 36" pushbrooms



Mops & Frames



Floor Dust Mop Frames

- 3104** 18" Frame only
 - 3105G** 24" Frame only
 - 3106G** 36" Frame only
 - 3107G** 48" Frame only
 - 3108G** 60" Handle with quick release
- 5" Wide Series. *Frame & Handle Sold Separately*

Electrostatic Synthetic Dust Mops

- 3100R** Red 18"
 - 3101R** Red 24"
 - 3102R** Red 36"
 - 3103R** Red 48"
- Fabric back with tie closures. 5"
Frame & Handle Sold Separately

Dust Pans



- 3005** 12"
 - 4312** 15" Clip on handle
- Plastic Dust Pan.



- 4088** 16"
- Metal Dust Pan, Heavy duty.



- 148237**
- Vileda Dust Pan and Brush Set
Clip-on short-handled brush and dustpan. Flagged tips trap dust and dirt, ergo handle



497-1



3031G



10182



Lobby Dust Pan

- 497-1** 25" metal handle, 13-1/2"W x 14"D
- 3031G** 11" w/snap lock feature, ergo handle
- 10182** 12" w/snap lock feature and handle clip

Litter Scoop

- HC0353** Frame & Bag
 - HC0356** Repl. Bag Only
- Litter, Trash, garden debris, good for indoors and outdoors.
Heavy duty bag

Carpet Sweepers



421288BLA



421288BLA



421388BLA

Floor & Carpet

- 421288BLA** 8" W x 9-1/2" L
Rubbermaid 6.5" sweep path, 44" handle. For bare floors or low pile carpets

Dual Action Floor & Carpet

- 421388BLA** 9-1/2"W x 11-1/4"L
Rubbermaid 7.5" sweep path, 44" handle. For bare floors or low pile carpets. Two brush rollers for maximum cleaning and versatility.



Floor Squeegee



4090 22"
Reinforced double foam floor squeegee. First blade pushes, second wipes. Ideal for uneven surfaces.
Tapered Handle Sold Separately



TCP324C 24"
Security Steel Floor Squeegee. Bright yellow for security, chemical resistant
Includes 54" Handle



TCP2324 24" Straight
TCP2324C 24" Str. w/wood handle
Aluminum floor squeegee. Neoprene rubber blade for smooth or semi-smooth surfaces. Resistant to oil and chemicals, safe spark-free use, won't rust



TCP2424 24" Curved
TCP2430 30" Curved
Aluminum floor squeegee. Neoprene rubber blade for smooth or semi-smooth surfaces. Resistant to oil and chemicals, safe spark-free use, won't rust
Tapered Handle Sold Separately



25330 30"
Moss foam rubber squeegee. Effectively cleans light and medium debris on smooth and semi-smooth surfaces.
Tapered Handle Sold Separately



3308 36" Curved
Single-edge floor squeegee. Cleans heavy debris on all types of surfaces. Heavy-duty, 14-gauge zinc plated steel frame. Accepts tapered handles.
Tapered Handle Sold Separately



36036 36"
Industrial floor squeegee. Rust-resistant and lightweight. Ideal for moving large amounts of liquid over smooth or rough surfaces.
Tapered Handle Sold Separately



4200 Handle w/ 6 blades
4201 Repl. Blades (5/pk)
12" long handle. Use this scraper for the effective removal of chewing gum, chipping paint, or tape!

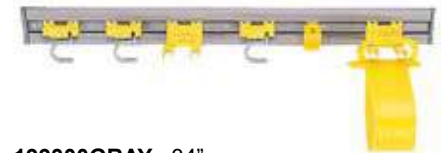

199300GRAY 34"
Tool Holder Kit. S-hooks hold 5/8" to 1 1/4" (1.6 cm to 3.2 cm) handle diameters. Deep double hooks afford easy accessibility. Clip holder for work notes and instructions.

Replacement Handles



Tapered Handles
2514 54" X 15/16"
52506 54" X 1-1/8"
52513 60" X 1-1/8"
For Floor Squeegees, coarse sweeping brooms and window washing equipment



Threaded Wood Lacquered
52504 54" X 15/16"
Larger diameter for greater strength
For brooms or mop heads.



Metal Tip Lacquered
4075 54" X 15/16"
4076 60" X 15/16"
For push brooms or wash brushes with added strength.



Fiberglass Threaded Tip
2410 60" X 1"
For brooms or wring wet mops.

Professional products for professional needs!



New!

Reduce chemical usage and pickup more bacteria with microfiber!

Globe Microfiber Flat Mop System. The fast connect system allows frames and handle to be used interchangeably.

New!



GL GLOBE

- 3312 12"
- 3325GL 18"
- 3326G 24"

Microfiber Wet Mop Pads.

Dense 3-5 micrometer quality fibre removes more dust, dirt, and microbes than conventional cleaning products.

New!



- 3362 12"
- 3368 18"
- 3320G 18" With Fringe
- 3374 24"

Microfiber Dry Dust Pads.

High-pile and looped fringe construction grabs and hold larger dust particles and debris.

New!



GL GLOBE

- 3306G 12" Frame
- 3307G 18" Frame
- 3308G 24" Frame
- 3305G 60" Telescopic Hdle



- Q74500YL00 20" - 40" Short extension handle
- Q75000YL00 58" Handle
- Q75500YL00 48" - 72" Straight handle
- Q760000000 48" - 72" Ergo Handle

Rubbermaid Quick Connect Handles. Lightweight aluminum, Fits all Rubbermaid quick connect frames and heads. Also available in new Executive series styling.

1863894

Rubbermaid Double Sided Folding Mop Frame.

Use with Rubbermaid Double-Sided microfiber mops. *(Not recommended for use with Q76000 or Q75000). Use with Double sided mops and Hygen Filter Bucket.*



- Q56000YL00 18" Wet/Dry Frame
- Q58000YL00 36" Dusting Frame
- Q59000YL00 48" Dusting Frame
- Q59500YL00 60" Dusting Frame

Rubbermaid Hygen Quick Connect Frames. Rounded plastic end caps protect walls and furniture. Lightweight aluminum. Use with quick connect handles.

Removes up to 80% more dust and dirt than traditional cotton.



Q41200GR00



Q41800GR00

- | | | |
|------|-------------------|--------------------|
| Size | Microfiber | Microfiber Fringed |
| 18" | Q41200GR00 | Q41800GR00 |
| 36" | Q43600GR00 | Q43800GR00 |
| 48" | Q44800GR00 | Q44900GR00 |
| 60" | n/a | Q46000GR00 |

Rubbermaid Microfiber Dust Mops. Scrubbing strips, higher pile looped end construction, capture and hold more dust and debris. Withstands 200F hot water laundering and bleach safe. Green. Fringed.



Q41000BL00



Q41500BL00

- Q41000BL00 18" Mop (Blue)
- Q41500BL00 18" Mop w/scrubber (Blue)

Rubbermaid Microfiber Damp Mops. Superior microfiber textiles proven to remove 99.9% of microorganisms. Scrubbing strips. Reduces water and chemical consumption up to 90%. Withstands 200F hot water laundering and bleach safe. Other styles available. Use with 18" frame.

Clean up to 500sqft with one wring! Cleans up to 20% faster than string mops!



1791678



1791794



1791791



1791792



1791679

- 1791678 General Purpose Smooth surfaces
- 1791796 Rough Surface Ceramic tile, stone, terrazzo
- 1791791 Wet & Scrub Smooth surfaces
- 1791792 Fringed Dust Mop Smooth surfaces
- 1791679 Wet and Dust Mop Plus for double sided Pulse

Rubbermaid Double Sided Microfiber Mops. Superior durability. Double sided design, twice the coverage. 17.5"L x 12"W to be used with double sided frame.





**Small in size,
big in performance!**

138841

UltraSpeed Mini Starter Kit includes

- 1 10L bucket
- 1 wringer
- 1 frame
- 1 MicroLite pad
- 1 MicroSafe pad

UltraSpeed Mini Kit (Handle sold sep)



UltraSpeed Mini is the latest addition to the highly successful **UltraSpeed family**, created specifically for **small area cleaning tasks** (10 - 30 m²). The compact 10 L bucket and flat mop makes it ideal for offices, cafes, small retailers and restaurants, as well as reception areas. UltraSpeed Mini is a small and compact system, that features the ergonomics, performance and hygiene benefits of the existing UltraSpeed range.

ACCESSORIES



138844

UltraSpeed Mini Handle

The textured finish gives an improved "soft grip". Handle extendable from 32"-56", with hook attachment for easy storage.



517556

Replacement Mini Mop Frame

Light and durable break frame. Swivel joint for easy cleaning of vertical surfaces. 14"



137573

MicroLite Mop

90% PES microfibres for outstanding cleaning performance, 10% PA fibre (grey) for stubborn dirt removal, Colour coded tags. 14"



137574

MicroSafe Mop

Developed especially for the use on rough and safety floors. Extra hard cut pile brush fibres, Colour coded tags. 14"

Swiffer - Wet mop



REFILL

PG08441 12/pk
Swiffer Wet Jet refill pads.



REFILL

23679 Fresh Scent
PG24334 Citrus

Swiffer Wet Jet refill multi-purpose cleaning solution. Dissolves tough, greasy and sticky dirt and leaves a fresh fragrance. Fast drying and non-streaking. 1.25L

92811

Swiffer Wet Jet Starter Kit.

- Swiffer Wet Jet powermop
- 500ml multi-purpose cleaning solution
- 5 refill pads

Swiffer - Dry Mop



Pro
GRADE



PG09060EA

Swiffer Sweeper Handle

Cleans up what a mop and broom leave behind.

REFILL

35154 12/pk
Swiffer Sweeper Wet Cloths.

Pre-moistened cloths easily remove soils from floors.

REFILL

33407 32/pk
Swiffer Sweeper Dry Cloths.
Thick dry cloths.



Complete & Refills



D708 8oz /225g
D7010 10oz /275g
D7012 12oz /350g
D7016 16oz /450g
Cotton Yacht/Deck Mop.
 4-Ply cotton cut end, highly absorbent, 48" metal handle



1508 8oz
1512 12oz
Wring EZY cotton mop head
 (cut ends) threads onto stand-ard threaded handle.



1805 9oz
TuffStuff looped end, blended yarn mop head.
 Ringtail, launderable. Threads onto standard threaded handle.



20702 Complete Mop
20751 Refill
Classic Bee Mop, angled head for thorough cleaning, Super dry sponge, good for all floor types, easy wring handle.



117526 Classic Mop
117529 Classic Mop Refill Only
Vileda Classic Cotton Mop.
 Highly absorbent cotton mop for deep cleaning both smooth and more irregular surfaces, but also to wipe out spills and splashes. 8oz.



119998 SuperMop
129301 SuperMop Refill Only
Vileda SuperMop string mop.
 Microfibre and cotton woven strings absorb, lift stubborn, greasy dirt and polish to a shine. Ideal for cleaning rougher surfaces, and deep inside grooves and corners.



122438 Super Twist Mop
129272 Super Twist Refill Only
Vileda Super Twist string mop.
 Red spot eraser removes the toughest dirt spots without scratching your floors, Blue microfibre Smartfibres effectively collect hair and particles, ultra-absorbent, machine washable



148241 Micro Twist Mop
148242 Micro Twist Refill Only
Vileda MicroTwist mop.
 Built-in ratchet-twist system wrings out more water, double tail bands, 100% microfibre, super-absorbent



143153 Mop & Bucket System
143124 Mop Refill Only
Vileda Easy Wring Spin Mop & Bucket System.
 Exclusive bucket design with built-in wringer with foot activated pedal, 100% microfibre head, telescopic handle to adjust to height and extend reach.



152985 Microfibre Spray Mop
152995 Refill Pad Only
Vileda ProMist Spray Mop
 Fill with your favorite cleaning solution, spray and clean, cleans and dries floors quickly, 360° swivel head, fine mist sprayer, microfibre pad with scrub zone, machine washable refills. No batteries needed, cleaning solution not included.

Handles Only



3119G 54"
3120G 60"
Fibreglass Handles, plastic quick bit head, for narrow headband mops



540WQ 54"
Quick Change Wood Handle, 1-1/8" diameter, metal hardware



1660 60"
Jaw Wet Mop Handle, for wide headband mops

See page 61 for more handles to choose from or go online to checkout our selection!

www.amresupply.com



Mop Heads

Choosing the right mops for the right job!

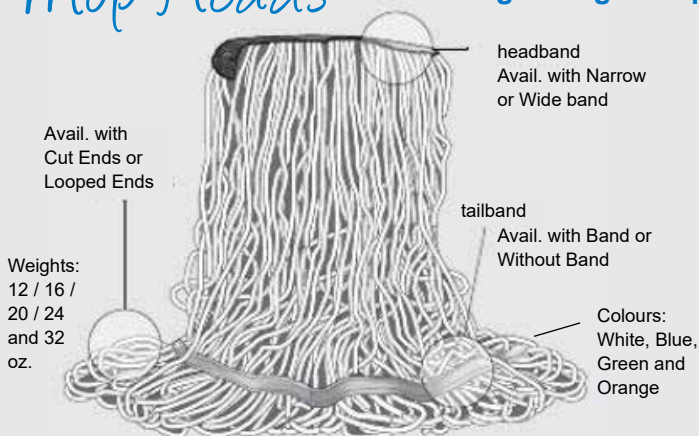

COTTON

Good absorption and retention. Low initial cost.
USES: General, picking up liquids and scrubbing.

SYNTHETIC

Long staple fiber for superior tensile strength, no lint.
USES: Rough surfaces

Styles:



synthetic



cotton



cut



loop

Ordering Chart

PART #	TYPE	BAND	CUT OR LOOPED	COLOUR	SIZE
3085G	Synthetic	Narrow	Cut	White	12oz
3086G	Synthetic	Narrow	Cut	White	16oz
3087G	Synthetic	Narrow	Cut	White	20oz
3088G	Synthetic	Narrow	Cut	White	24oz
3089G	Synthetic	Narrow	Cut	White	32oz
3012	Synthetic	Narrow	Looped	Blue	12oz
3090	Synthetic	Narrow	Looped	Blue	16oz
3091	Synthetic	Narrow	Looped	Blue	20oz
3092	Synthetic	Narrow	Looped	Blue	24oz
3832	Synthetic	Narrow	Looped	Blue	32oz
3090O	Synthetic	Narrow	Looped	Orange	16oz
3091O	Synthetic	Narrow	Looped	Orange	20oz
3092O	Synthetic	Narrow	Looped	Orange	24oz
3832O	Synthetic	Narrow	Looped	Orange	32oz
3050B	Synthetic	Wide	Looped	Blue	16oz
3051B	Synthetic	Wide	Looped	Blue	20oz
3052B	Synthetic	Wide	Looped	Blue	24oz
3096	Synthetic	Narrow	Cut	Blue	16oz
3097	Synthetic	Narrow	Cut	Blue	20oz
3098	Synthetic	Narrow	Cut	Blue	24oz
3099	Synthetic	Narrow	Cut	Blue	32oz
3093G	Cotton	Narrow	Cut	White	16oz
3094	Cotton	Narrow	Cut	White	20oz
3095	Cotton	Narrow	Cut	White	24oz
3232	Cotton	Narrow	Cut	White	32oz

SIDE PRESS



HC0080YE
Bucket & sidepress
wringer combo, 26 quart

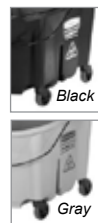

WaveBrake®

758088YEL Yellow
1863896 Black
1863897 Gray
Rubbermaid bucket and side-
press wringer combo, reduced
splashing, 35 quart



DOWN PRESS

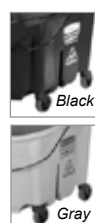

WaveBrake®

757788YEL Yellow
1863898 Black
1863899 Gray
Rubbermaid WaveBrake bucket
and downpress wringer combo
reduced splashing, 35 quart



3078
Bucket & downpress wringer,
35 quart



Buckets



HC8006RD 6qt Red
HC8006BL 6qt Blue
HC8006GN 6qt Green
 Centurion Small Utility Pail.
 Great as stand alone, also fits
 Centurion Janitor cart.



3605 11qt
 Plastic Bucket with easy
 pour spout



800 15qt
 Plastic Bucket with wringer



21051 16qt
 Bee Mop Bucket with easy
 pour spout



268 17qt
 Plastic Bucket with Easy
 Pour Grip



HC0067
 Window Cleaning Bucket
 with 4 castors



3621
 Window Cleaning Bucket with
 4 castors and screen



New!



3350G
 Dock N' Mop Microfiber Mop
 Bucket with a snap-on water
 tight lid.

Floor Safety



MULTILINGUAL
 English, French,
 Spanish



1867505 26" Black
1867506 26" Gray
 Rubbermaid Executive Series multi-
 lingual 2 sided floor safety sign.



MULTILINGUAL
 English, French,
 Spanish, German



1867509 38" Black
1867510 38" Gray
 Rubbermaid Executive Series multilingual
 4 sided floor safety sign.



MULTILINGUAL
 English, French



7112 25"
 Caution Wet Floor Sign. Bilingual 2-sided

MULTILINGUAL
 English, French,
 Spanish, German



611278YEL 25"
 Closed Sign. Multilingual,
 2-sided

MULTILINGUAL
 English, French,
 Spanish, German



611477YEL 37"
 Closed Wet Floor Sign.
 Multilingual, 4-sided

MULTILINGUAL
 English, French



7200G 26"
7201G 36"
 Closed Wet Floor Cone.
 Bilingual, 4-sided



MULTILINGUAL
 English, French

7115G
 Hanging Closed
 For Cleaning Sign.
 Bilingual

MULTILINGUAL
 English, French,
 Spanish



7114G 19.5"
 Pop-Up Safety Cone with Storage
 Tube. Multilingual, 3-sided



Open



Closed

9S1100YEL
Mobile Barrier - can be set straight, curved or in a
 circle. 13 ft. long with 16 articulating panels, has
 two 5" non-marking wheels



625 Stainless Steel
Frost Hands Free Napkin Disposal Unit

Ideal for high traffic areas, Door opens at 4" from sensor and remains open for 5 sec. Battery life 10,000 cycles or 2 years, 4xC required, leak-proof 5.1L poly liner.
10-3/4" W x 17-5/8" H x 4" D



B-270 Satin-finish stainless st.
Sanitary Napkin Disposal

Cover is drawn, one-piece construction; secured to cabinet with full-length stainless steel piano-hinge. Capacity: 1.0-gal. (3.8-L).
Unit 7 1/2"W x 10"H x 3 13/16"D (190 x 255 x 95mm).



402338 White Rubbermaid Sanitary Bin, Designed to provide a safe and hygienic way to dispose of sanitary waste, lined, foot pedal operation, 5 Gallon,
19" H x 22" D x 6" W



1120 Stainless Steel **Event log display frame.** Tamper resistant opening without the use of a key, fits 8-1/2"x11" paper, durable acrylic glazing, c/w mounting screws.
Size: 9.5"W x 12.125"H x .45"D



620 White
622 Stainless Steel
Economical surface mounted disposal.

Flexible mounting and ease of maintenance for partition panel systems or any type of wall construction. Pivoting self closing lid. Easy cleaning and maintenance. French/English napkin disposal label is embossed on lid. Overall dim: 8"W (20.3) x 13-1/4"H (33.6) x 4-1/2"D (11.4).



14500147 Kraft Waxed Paper Receptacle Liners for use with Convertible Sanitary Napkin Receptacles HOS 250/201W, HOS ND-1E, Sanisac and all standard wall units. 7-1/2w x 3-1/2d x 10-1/4h with gusset. 500 liners per case

New!



878 Container
878-500 Internal Liner
Frost Stainless Steel Biomedical Sharps Disposal System. Once full, just throw whole internal liner away.

Facial Tissue Dispensers



175F Recessed mounting Polished chrome. 20 ga. steel. Easy removal of facial tissue. Surface mount front secured with "P" keyed lock to prevent theft.
11-7/8" W x 6-1/4" H x 2-1/2" D



01-1010 - Chrome Recessed Tissue Holder.
11-15/16" x 6" x 2-3/8"



180 Surface mounted Polished chrome. 20 ga. steel. Easy removal of facial tissue. Surface mount front secured with "P" keyed lock to prevent theft.
11-7/8" W x 6-1/4" H x 2-1/2" D



Toilet Seat Cover Dispenser



HG1 White Plastic
HG1-SS Stainless Steel
Holds 2 sleeves of 250 1/2 fold toilet seat cover refills, sold separately.
Paper: Refills separate - HG2500 (10x250/case) - HG1000 (4 x 250/case) 16-1/8" x 2-1/2" x 11-1/2"



Baby Changing Station



781888LPLAT Horizontal Station
781788WHT Liners (320/pk)
Rubbermaid Commercial Horizontal Baby Changing Station. *Other models available.* Platinum color.





Hands Free



1187 White 120v
1187-1 White 220v
 Frost Cast aluminium, 20 second drying time. 2200 watts, 61-67 db, Brushless 3,450 rpm motor. Sensitive distance of sensor: 4-12". There is a .6 sec delay for on and a 2 second delay for off.
5 year warranty.



Express High Speed w/L.E.D.



1192 White, 120v
1193 Satin Stainless St., 120v
 Frost hand dryer. Areas with limited space requirements. Drying time: 10-12 seconds.
 - Unit rated at 1600W. Heat element - 900W.
 - Dual ball bearings brush motor is 700W, 18000 R.P.M.
 - Air speed output: 100 m/s. Sensor range: 7". 78dB
5 year warranty. Bright blue L.E.D. helps identify ideal drying area.



NOVA 5 Push Button Hand Dryer



0112-00 White
 NOVA 5 is a low-sound-level and durable hand dryer. The motor is brushless, so no need for brush replacement. This dryer is a great washroom solution for medium traffic facilities. ADA Compliant
5-Year warranty



Eco-Fast Series



1194F Chrome, 120v
1195 White, 120v
1196 Stainless St., 120v
 Frost hand dryer ideal for renovations and areas with 15 amp circuits.
 - Unit is rated at 1000W. Heat element: 500W
 - Operating Voltage: 110-120 VAC, 50/60Hz, 0.84-1kw., Amps 8.4. Brush motor with dual ball bearings 500W, 29,000 RPM. 78dB
5 year warranty.

New!
Airblade V-Quiet
 "HU02" models are now
30% more quiet and are
 certified by Quiet Mark!



Dyson Airblade V
307173-01 HU02 White 110/120V
307174-01 HU02 Nickel 110/120V
307172-01 HU02 Nickel 208V
 Modern & sleek
 - 12 second dry time
 - 5yr warranty
 9.2"W x 15.5"H x 3.93"D



Dyson AB14 Airblade dB
301854-01 AB14 White 110/120V
301853-01 AB14 Grey 110/120V
300677-01 AB14 Grey 208V
 - 50% Quieter
 - 12 second dry time
 - 5yr warranty
 12"W x 26"H x 9-3/4"D

Replacement Filters & Acc.

920336-01 HEPA Filter AB02/04/06/14
965280-01 HEPA Filter AB12
965395-01 HEPA Filter AB09/10/11
964691-01 AB12 S.S. Back Plate with splash guard

dyson airblade



Dyson Airblade Tap

301848-01 AB09 Short
301849-01 AB10 Long
301850-01 AB11 Wall
 Wash and dry hands in the sink
 - Infrared hands free
 - 120V, 1400W
 - 14 second dry time
 - 1.9 & 4L/min flow

Check out our website,
 or ask one of our sales
 representatives,
 about current
Dyson promotions!

dyson



Desk



Tower

305217-01 Blue/Iron Desk
305216-01 White/Silver Desk
305161-01 Blue/Iron Tower
305160-01 White/Silver Tower

Dyson pure cool link Fan/Air Purifiers
 Removes 99.97% of allergens, eliminates toxic fumes and odours, purifies all year round and cools in summer, automatically monitors, reacts and purifies

dyson



Blue/Iron Desk



White/Silver Desk

Hot & Cool models

305573-01 Blue/Iron Desk
305574-01 White/Silver Desk
 Dyson Pure Hot+Cool Air Purifier
 Automatically monitors, reacts and purifies, easily monitor your indoor air quality and see live, local air quality metrics from your smartphone, captures smells, powerful airflow, auto night mode and along with purifying, heats and cools.





FOLD

Xpress Countertop - Interfold-Multifold

302020 White
302028 Black
302030 Stainless Steel
 Towel dispenser, upscale touch, only one towel at a time, minimizing cross contamination, reducing waste and refilling expenses. Anti-slip pads, overflow protection, refill level indicator.
Paper: MB574
Size: 12.7"W x 7.2"H x 4.6"D
Perfect for high end restrooms, offices etc...



FOLD OR ROLL

Universal

101 White
103 Stainless Steel
101-1 White with lock
101-J Jumbo, White with lock
 Accepts standard single fold and roll towels (max. 6"Dia. and up to 10"L), *jumbo version* (max 7-1/8"dia and up to 9"L).
Paper: 75000250, 75000251, SB1840A
Size: 9.5" x 10.5" Regular 6.75"D Jumbo 7.25"D

ROLL

Essential Scott "Mechanical Hands-Free"



46253 Smoke
 Capacity: 1 Roll of Essential style rolls, portion controlled, mechanical hand-free dispensing. Designed to save you time and money.
Paper: SC02001
(must be Essential compatible roll)
Size: 12.63"W x 16.13"H x 10.2"D

ROLL

H21 Tork "Lever Auto Transfer"



84TR Smoke
 Capacity: 1 Roll 8" Dia, 3" Stub roll. Translucent cover, easy to clean and maintain. Only touch the paper you need. It has a stub roll auto-transfer feature. Built-in pilferage control.
Paper: Paper: RB800, RB206, RK350E, RB6002, RK600E, RK800E, RK206E, 75000257, 75000256, 75000259, 75000258, RB600
Size: 15.5" H x 12.94" W x 9.25" D

ROLL

H21 Tork "Push Bar"



87T Smoke/Grey
 Capacity: 1 Roll 8" Dia., 3" Stub Roll. See-through front. Large capacity. Push Bar controlled consumption.
Paper: RB800, RB206, RK350E, RB6002, RK600E, RK800E, RK206E, 75000257, 75000256, 75000259, 75000258, RB600
Size: 15.75" H x 10.5" W x 8.75" D

ROLL

H1 Tork "Elevation Matic"



5510202 White
551028A Black
 Capacity: 1 Roll of H1 style rolls, portion controlled, mechanical hands-free dispensing, for high traffic restrooms and push bar for emergency feeds.
Paper: 290089 or 290088
(Must be H1 compatible roll styles)
Size: 13.3" W x 14.7" H x 8" D



FOLD

Universal - Multifold

105 White
107F Stainless Steel
 The compact makes it ideal for use in any room or location. Front loading and comes with lock.
Paper: MB574
Size: 11"W x 13.5"H x 4.2"D

ROLL

M2 Tork "Elevation" Centerfeed



559020A White
559028A Black
 Easy, one-handed touch free operation and Portion Control feature dispenses one towel every time.
Paper: 120932 or 121202 M2 style Tork Center-feed Towel only.
Size: 14.39" H x 9.42" W x 8.95" D - (1 Roll Cap.)

ROLL

H1 Tork "Intuition" Touch Free Electronic



5511201 White
5511281 Black
 Capacity: 1 Roll of H1 style rolls. Touch-free electronic, two dispensing modes, sensor mode and hanging mode, for high-traffic venues. Adj. towel length. Batteries lasts up to 40 rolls. Uses 3 "D size" batteries.
Paper: 290089 or 290088 (Must be H1 comp. roll styles)
Size: 14.6" H x 13.2" W x 8.1" D

ROLL

H21 Tork "Electronic Touch Free Auto-Transfer"



86ECO Smoke
 Capacity: 1 Roll 8" diameter, 3" Stub roll. Touch-free electronic dispenser, translucent cover, textured surface hides scratches. Sturdy key lock. Takes 4-D cell batteries (not included).
Paper: RB800, RB206, RK350E, RB6002, RK600E, RK800E, RK206E, 75000257, 75000256, 75000259, 75000258, RB600
Size: 14.39" H x 11.78" W x 9.12" D

Napkin Dispensers

Reduces paper use up to 25%



6232000



6332000



6232000 Tabletop Black
6332000 Stand-up Black
Tork Xpressnap Napkin Dispensers. Great for all sizes of lunchrooms, offices, coffee areas etc... Other colors & styles available.
 6232000: 250 capacity, 6.1" x 7.9" x 5.9"
 6332000: 1000 capacity, 24.5" x 9.25" x 9.25"
Paper: 908EX, DX900



OPEN - Paper Dispensers



Single

Double

Heavy duty economical dispenser.

146 Single - 6-3/8" W x 3-1/8" H x 4-1/4" Ext
150 Double - 12-5/8" W x 3-1/8" H x 4-1/4" Ext
 Tension springs restrict paper consumption. Concealed self locking device, polished chrome.
Paper: Standard toilet tissue rolls including 4.2" x 4.5", 500 sheet rolls



Multi-Roll Toilet Tissue Successive Access

165 Stainless Steel, Surface Mount
165-R Stainless Steel, Recessed
 Stainless Steel Heavy duty efficient dispenser. Will only dispense its reserve second roll after the first roll is empty. Capacity - two rolls per unit, c/w keyed tumbler lock.
Paper: Standard toilet tissue rolls
Size: 6" W x 11-3/8" H x 6-1/2" D

CLOSED - Paper Dispensers

SINGLE ROLL



Tork Elevation Bath Tissue Jumbo Roll
555028A Black
555020A White
 For high-traffic washrooms. Roll is protected creating less waste. A new stub roll feature provides extra high capacity.
Paper: 12024402
Size: 13.6" W x 10.8" H x 5.2" D



Tork Elevation Bath Tissue Jumbo Roll
554020A White
554028A Black
 1 Roll with 1 Stub Roll. Extra high capacity reduces maintenance costs. Eliminates risk of cutting or scratching hands.
Paper: 12021502
Size: 14.2" H x 17.2" W x 5.2" D



Jumbo Toilet Paper Dispenser
66TR Smoke
 High capacity for reduced costs and fewer service interruptions. Built-in pilferage control.
Paper: TJ0922A, TJ0912A, 75004361
Size: 11.8"H x 10.6"W x 5.9"D



Kimberly-Clark JRT Bath Tissue Dispenser
09602 Smoke/Grey
 1 Roll Coreless. High capacity makes it ideal for high-traffic areas and reduces maintenance costs. Easy load dispenser with keyless entry.
Paper: 07006
Size: 14.25" x 9.75" x 6"

CLOSED - Paper Dispensers

DOUBLE ROLL



Jumbo Toilet Paper Dispenser
56TR Smoke,
 See-through front reduces maintenance, allows quick and easy service checks.
Paper: TJ0922A, TJ0912A, 75004361
Size: 11.8"H x 19.3"W x 5.5"D



59TR Smoke
 High impact plastic and design help prevent breakage. Easy to clean and maintain
Paper: 75000284, 05485, 05144, 05705 or any other standard toilet paper rolls
Size: 8.5" H x 12.75" W x 5.57" D



Kimberly-Clark JRT Bath Tissue Dispenser
09608 Smoke/Grey
 Capacity: 2 Roll Coreless. Dispenser is designed to minimize run-out, waste, and maintenance time. No door, no key, and no core to throw away.
Paper: 07006
Size: 20" x 11" x 6"



Tork "Elevation" Jumbo Roll Mini
5555200 White
5555290 Black
 Compact, high-capacity, for high-traffic washrooms. Eliminates risk of cutting or scratching hands. Protected rolls - less waste.
Paper: Use with 12024402
Size: 10" H x 17" W x 5.7" D





Universal bathroom tissue. 2-ply tissue

Part #	Description	Colour	Sheet Size	Ply	Sheets/Roll	Roll/Case
05485	Toilet Paper	White	4.2" x 3.8"	2	500	48
TM1604	Toilet Paper	White	4.2" x 3.75"	2	750	48
75000284	Toilet Paper	White	4.5" x 3.8"	2	500	48

High quality at the most economical price. Ideal for all public environments. Individually wrapped roller for sanitary protection. For cost-conscious buyers while still providing standard softness, absorbency, and strength.



Classic quality, 2-ply tissue

Part #	Description	Colour	Sheet Size	Ply	Sheets/Roll	Roll/Case
05144	Toilet Paper	White	4.2" x 3.8"	2	429	48

Protective poly individually overwrapped rolls, hygienic, reduces risk of moisture damage, recyclable. White cores give roll an upscale look. 4.2" and wide sheet fits most dispensers.



Purex 2 Ply Premium Bathroom Tissue

Part #	Description	Colour	Sheet Size	Ply	Sheets/Roll	Roll/Case
05705	Toilet Paper	White	4.2" x 4"	2	506	60

Quilted, embossed. Individually poly recyclable wrapped. Ply bonded to reduce risk of separation. Tail tie for roll start. Upscale white core. Made with 100% recycled fiber. Perforated overwrap for quick easy access. Popular choice for quality hotels everywhere.

Trusted by quality Hotels



Scott "Coreless JRT Jr." bathroom tissue - 2-ply tissue

Part #	Description	Colour	Ft./Width	Ply	Roll Dia.	Core Dia.	Roll/Case
07006	Coreless	White	1150' x 3.78"	2	9"	Coreless	12

Designed for Kimberly-Clark JRT Bath Tissue System. Ultra-High capacity gives you 15% more bath tissue than standard jumbo rolls with the elimination of the core. Enjoy efficient maintenance, fewer hassles, and less waste.



Tork "Advanced" 2.34" Core jumbo , 2-ply tissue

Part #	Description	Colour	Ft./Width	Ply	Roll Dia.	Core Dia.	Roll/Case
12021502	Jumbo Tissue	White	1600' x 3.55"	2	10"	2.34"	6

High capacity, fewer refills and reduces labor. Large size is pilfer proof, hard to conceal. Can't use at home. Reduced stub roll means less waste. Fewer cores and no wrappers leads to source reduction. Less storage space is needed. Perforated. Made from 100% recycled fibre provides environmental benefits, and a positive image builder.



Tork "Universal" 3.3" Core, soft, absorbent 2-ply jumbo tissue

Part #	Description	Colour	Ft./Width	Ply	Roll Dia.	Core Dia.	Roll/Case
TJ0912A	Jumbo Tissue	White	2000' x 3.55"	1	8.8"	3.3"	12
TJ0922A	Jumbo Tissue	White	1000' x 3.55"	2	8.8"	3.3"	12

Quality, value & performance. Made from 100% recycled fibres with no added dyes or fragrances. Rapid break-up capability is ideal for all plumbing systems. Universal core is designed to fit virtually all size jumbo tissue dispensers. Extra long lasting tissue, less maintenance and better control of paper waste. Smaller case cubes frees up about 40% more storage space vs. conventional rolls.



Tork Advanced jumbo bath tissue's high capacity - 2-ply tissue

Part #	Description	Colour	Ft./Width	Ply	Roll Dia.	Core Dia.	Roll/Case
12024402	Mini Jumbo	White	751' x 3.55"	2	7.4"	2.3"	12

Large size is pilfer proof, hard to conceal. Can't use at home. Reduced stub roll means less waste. Fewer cores and no wrappers leads to source reduction. Less storage space is needed. Made from 100% recycled fiber provides environmental benefits, and a positive image builder.



Prime Source 3.3" Core, Jumbo bathroom - 2 ply tissue.

Part #	Description	Colour	Ft./Width	Ply	Roll Dia.	Core Dia.	Roll/Case
75004361	Jr. Jumbo Tissue	White	1000' x 4"	2	8.8"	3.3"	12

High quality at the most economical price. Ideal for all public environments. A great choice to watch the budget without compromising quality or comfort. 3.3" Core to fit most brands of Jumbo Roll dispensers.



Tork "Universal" Perforated Paper Towel - 2 ply

Part #	Description	Colour	Ply	Towel Size	Towels /Roll	Roll Dia	Rolls /Case	Sheets /Case
HB1990A	Perforated Reg.	White	2	11" x 9" H	84	4.6"	30	2520
HB1995	Perforated Jumbo	White	2	11" x 9" H	210	5.45"	12	2520
HB1995EA	Perforated Jumbo	White	2	11" x 9" H	210	5.45"	1	210

High-bulk, 2-ply construction that maximizes absorbency for superior spill holding power using fewer towels. It's ideal for cleaning and wiping all surfaces. This super strong towel holds together even on tough jobs. The 210 count gives you twice the toweling. Individually wrapped. Made from 100% recycled fibres.

Prime Source White, Household Roll Towels - 2 ply

Part #	Description	Colour	Ply	Towel Size	Towels /Roll	Roll Dia	Rolls /Case	Sheets /Case
75000260	Perforated Reg.	White	2	11" x 9" H	84	4.5"	30	2520

High quality value priced towel, ideal for everyday cleaning and public area use. Soft and absorbent.

Swan Professional Perforated Towel Roll - 2 ply

Part #	Description	Colour	Ply	Towel Size	Towels /Roll	Roll Dia	Rolls /Case	Sheets /Case
01650	Perforated Reg.	White	2	11" x 9" H	90	4.6"	24	2160

Good absorbency and utility in a Professional / Kitchen Towel. Individually wrapped rolls prevent contamination in workplace. The right blend quality, performance and cost effectiveness.

Tork "Advanced" Centerfeed Towels M2 - 2 ply

Part #	Description	Colour	Ply	Towel Size	Towels /Roll	Roll Dia /Core Dia.	Rolls /Case	Feet/Roll
120932	M2	White	2	7.6" x 11.8"	500	7.8" / 2.9"	6	492
121201	M2	White	2	9" x 11.8"	600	7.8" / 2.9"	6	590
121202	M2 Large	White	2	8.25" x 11.8"	610	7.9" / 2.9"	6	600

Offers one-at-a-time service, reduces waste. Fit M2 class Tork dispensers. High cap., reduces labor and refills. High absorbency - less towels used. Touch only dispensing towel. Made from 100% recycled fibre.

Tork "Universal" Hardwound Roll Hand Towels - 1 ply

Part #	Description	Colour	Ply	Towel Size	Feet /Roll	Roll Dia /Core Dia.	Rolls /Case	Feet /Case
RB206	Universal 206'	White	1	7.87"	206'	5" / 1.8"	24	4944
RK206E	Universal 206'	Natural	1	7.87"	206'	5" / 1.8"	24	4944
RB350	Universal 350'	White	1	7.87"	350'	5.5" / 1.8"	12	4200
RK350E	Universal 350'	Natural	1	7.87"	350'	5.5" / 1.8"	12	4200
RB6002	Universal 600'	White	1	7.87"	600'	6.7" / 1.8"	12	7200
RK600E	Universal 600'	Natural	1	7.87"	600'	6.7" / 1.8"	12	7200
RB600	Advanced 600'	White	1	7.87"	600'	7.8" / 1.8"	12	7200

Soft, strong, highly absorbent, quality, performance, and value. Embossing enhances hand feel and maximum absorbency, fewer towels used. Provides source reduction and less packaging. Long lasting rolls. Made from 100% recycled fibre provides environmental benefits.

Prime Source Roll Hand Towels - 1 ply

Part #	Description	Colour	Ply	Towel Size	Feet /Roll	Roll Dia /Core Dia.	Rolls /Case	Feet /Case
75000256	350'	White	1	8"	350'	5.5"/1.8"	12	4200
75000257	350'	Natural	1	8"	350'	5.5"/1.8"	12	4200
75000258	800'	White	1	8"	800'	8"/1.8"	6	4800
75000259	800'	Natural	1	8"	800'	8"/1.8"	6	4800

High quality value priced. For public environments, offices, public restrooms, lunch rooms, maintenance facilities, and schools. Economic choice of rolled hand towel without compromising quality.

Tork "Advanced" Hand Towel Roll H1 - 1 ply

Part #	Description	Colour	Ply	Roll Width	Roll Dia. /Core Dia.	Towels /Roll	Feet /Roll	Rolls /Case
290089	Advantage H1	White	1	7.75"	7.25" / 1.49"	884	700	6
290088	Universal H1	Natural	1	7.75"	7.25" / 1.49"	884	700	6

Designed for Tork Matic and Tork Intuition H1 style roll towel dispensers. Soft, strong, and highly absorbent, quality, performance, and value. Embossing enhances hand feel and maximum absorbency so fewer towels are used per hand dry. Made from 100% recycled fibre. *Note: Towels per roll will change depending on dispenser and length setting.



Natural



Natural



Natural



Hand Towels



Scott "Essential" Hardwood Roll Towels - 1 Ply

Part #	Description	Colour	Ply	Towel Size	Roll Dia/Core Dia	Feet/Roll	Rolls/Case
SC02001	Essential	White	1	8"	7.87"/1.75"	950	6

Designed for Scott Essential Towel Dispenser System. Hygienic. Dependable. Long-Lasting. The perfect solution for high-traffic areas. Environmentally responsible towel.



Tork "Universal" Singlefold Hand Towels - 1 ply

Part #	Description	Colour	Ply	Towel Size	Folded Size	Towels/Pk	Packs/Case
SB1840A	Universal Singlefold	White	1	10.25" x 9.12"	5.1" x 9.12"	250	16

Soft, absorbent, quality, performance and value. Embossing enhances hand feel. Reduce your overall costs and it fits all standard singlefold towel dispensers. Second fold creates 1/2" tab to aid dispensing. Towels are made from 100% recycled fibres providing environmental benefits, and a positive image builder.



Singlefold Hand Towels - 1 ply

Part #	Description	Colour	Ply	Towel Size	Folded Size	Towels/Pk	Packs/Case
75000250	Singlefold	Natural	1	10.5" X 9.3"	5.125" X 9.125"	250	16
75000251	Singlefold	White	1	10.5" X 9.3"	5.125" X 9.125"	250	16

High quality, value priced single fold towel by Prime Source. Reduce costs with controlled 1 at a time dispensing. Good for all facilities including offices, lunchrooms, shops, restrooms, etc.



Tork "Advanced" Multifold Hand Towels - 1 ply

Part #	Description	Colour	Ply	Towel Size	Folded Size	Towels/Pk	Packs/Case
MB550A	Advanced Multifold	White	1	9.5" x 9.12"	3.2" x 9.12"	250	16
MK530A	Advanced Multifold	Natural	1	9.5" x 9.12"	3.2" x 9.12"	250	16

Soft and absorbent towels provide the right combination of quality, performance and value. Embossing enhances hand feel and maximum performance. High wet strength provides a premium quality people appreciate. Fast absorbency helps to control usage. Towels are made from 100% recycled fibres providing environmental benefits, and a positive image builder.



Tork Xpress® Premium Soft Multifold Hand Towels - 1 ply

Part #	Description	Colour	Ply	Towel Size	Folded Size	Towels/Pk	Packs/Case
MB574	Premium Multifold	White	2	14.5" x 8.4"	3.6" x 8.4"	94	32

Larger, stronger towels don't tab or break apart, one-at-a-time dispensing. Hands dry faster, greater absorbency. High-performance towels, use fewer, resulting in greater cost savings. Maintain a high-end image with reduced waste and clutter. Contains a minimum of 50% recycled fiber content and a minimum of 40% Post Consumer fibers and is EPA compliant. FSC® Certified.

Your restroom makes an impression so make it luxurious!

Napkins



Tork Xpressnap Dispenser Napkins - 1 ply

Part#	Description	Colour	Ply	Napkin Size	Folded Size	Napkins/Pk	Packs/Case
908EX	Napkin	Natural	1	13" X 8.5"	6.5" X 4.25"	500	12
DX900	Napkin	White	1	13" X 8.5"	6.5" X 4.25"	500	12

Tork interfold napkins are 100% recycled. One at a time dispensing ensures reduced usage. Economical yet larger than competitive napkins offering strength, absorbency and quality.

Face Tissue



Tork Universal, Advanced & Facial Tissue - 2 ply

Part #	Description	Ply	Size	Tissue/Pk	Packs/Case
TF6810A	Advanced Tissue	2	8-1/5" x 8"	100	30

Extra soft and absorbent facial tissue offers the right combination of performance and value. The flat box style is ideal for the vanity or in-wall dispensers. Made from 100% recycled fibres.



PrimeSource Facial Tissue - 2 ply

Part #	Description	Ply	Size	Tissue/Pk	Packs/Case
75000283	Tissue	2	8" x 8-1/2"	100	30

High quality value priced facial tissue. As a quality brand that delivers the same softness and construction as other brand names you can rest assured that you can achieve an economy solution without compromising quality. Suitable for all public environments.



1.25" Hose Dia. Shop Vacuums

Shop-Vac Hang Up Mini®
Portable



shop-vac

202-10

1 gal, 1 H.P.

- Cord Length: 6 Feet
- Operation Sound Level: Quiet
- Hose Size: 1.25" Diameter
- Warranty: 2 Years
- Wall Mountable Design
- Hand Held Design



930-0482

4 gal, 4.5 H.P.

- Cord Length: 18 Feet
- Operation Sound Level: Quiet
- Hose Size: 1.25" Diameter
- Warranty: 3 Years
- Blower Feature
- Onboard Accessory Storage

1.25" Hose Dia. Accessories (fits all 1.25" Shop Vacs.)



906-43 3-piece set Round Brush, Gulper Nozzle and Crevice Tool



906-32 Dual Surface Nozzle. For both bare floors and carpets



906-14 3-piece Wand extension set



906-15 Round Brush. For dry pick-up tasks such as dirt, sawdust, furniture, or venetian blinds.



906-16 Crevice Tool. For radiators and vehicle interiors



906-19 Gulper Nozzle. The fast pick-up tool.



905-65 8' QSP® Hose w/handle & Airflow Control. Curved handle at the end of the hose, convenience & comfort.



1.5" Hose Dia. Shop Vacuums

Shop-Vac Heavy Duty Portable Contractor



shop-vac

587-3000

4 gal, 6 H.P.

- Cord Length: 6 Feet
- Operation Sound Level: Quiet
- Hose Size: 1.5" Diameter
- Warranty: 3 Year
- Lock-on Hose
- Hand Held Design

Shop-Vac Ultra



shop-vac

962-10

8 gal, 6 H.P.

- Cord Length: 18 Feet
- Oper. Sound Level: Quiet
- Hose Size: 1.5" Diameter
- Warranty: 3 Years
- Tank Drain
- Stainless St. Tank
- Lock-on Hose
- Blower Feature
- Onboard Accessory Storage

1.5" Dia Access

(fits all 1.5" Shop Vacs.)



906-44-9 Round Brush. Dusts and cleans irregular surfaces.



903-21-82 Master Nozzle



906-45 Crevice Tool. Vac access to all of those hard-to-reach areas where dirt and dust builds up

Adapters



906-49 Conversion Unit - the problem solver will adapt a hose size from 2 1/2" to 1 1/2".



906-85 Conversion Unit, 2-1/2" to 1-1/4". The problem solver will adapt a hose size



906-87 Universal Tool Adapter. Made of soft plastic that can be cut to many different diameters. Adapts to 1", 1-1/4", 1-1/2" and 2" exhaust ports.

2.5" Hose Dia. Shop Vacuums

Shop-Vac Ultra



shop-vac

962-09

10 gal, 5 H.P.

- Cord Length: 6 Feet
- Oper. Sound Level: Quiet
- Hose Size: 2.5" Diameter
- Warranty: 3 Years
- Tank Drain
- Lock-on Hose
- Blower Feature
- Onboard Acc. Storage

Shop-Vac Wet/Dry Pump



shop-vac

582-12

12 gal, 5 H.P.

- Cord Length: 12 Feet
- Oper. Sound Level: Quiet
- Hose Size: 2.5" Diameter
- Warranty: 3 Years
- Tank Drain
- Lock-on Hose
- Blower Feature
- Onboard Accessory Storage
- Built In Water Pump

2.5" Hose Dia. Accessories (fits all 2.5" Shop Vacs.)



801-78 Cleaning Kit. For large dry pick-ups, 6' hose, two Extension Wands, and an 8" Utility Nozzle



906-75 Utility Nozzle is ideal for most bulk dry pick-up jobs.



919-61 Claw Utility Nozzle (Fits 1-1/4", 1-1/2", 2-1/2"). Ideal for vehicle interiors, boats and campers.



906-84 2-Piece Extension Wands



906-78 Crevice Tool. Give your vac access to hard-to-reach areas.



906-77 14" Floor nozzle comes equipped with a built-in brush for wide area bulk dry pick-up



905-03 8' Hose. Large diameter helps prevent clogs when vacuuming bulky debris.

Canister



TARGA 330 - Dry - 1.4 hp - 9 amps - 4.4 gal

DB28541
 CFM..... 94
 Motor type..... 2 stage/Flow thru
 RPM..... 23,200
 dB rating 59
 Cord length..... 35'
 Hose size..... 8' x 1-1/2"



SOLD SEPARATELY

Tool kits:

DB28631 Tool/Accessory Kit
DB28501 Bags 10/pk



DB28631



TARGA 660 - Dry- 1.4 hp - 9 amps - 5.5 gal

DB28542
 CFM.....94
 Motor type.....2 stage/Flow Thru
 RPM.....23,200
 dB rating59
 Cord length.....50'
 Hose size.....8' x 1-1/2"



SOLD SEPARATELY

Tool kits:

DB28632 Tool/Accessory Kit
DB28502 Bags 10/pk



DB28632



TARGA 990 - Wet/Dry - 1.6 hp - 11.3 amps - 5.5 gal

DB28543
 Water lift91.5"
 CFM.....103
 Motor type.....2 Stage/Bypass
 RPM.....23,400
 dB rating62
 Cord length.....50'
 Hose size.....8' x 1-1/2"



SOLD SEPARATELY

Tool kits:

DB28633 Tool/Accessory Kit
DB28502 Bags 10/pk



DB28633

Power Nozzle - 14" / 5300RPM / 1.4Amp



DB28392
 Dustbane DB499 Professional Power Nozzle. Revolving brush includes soft horsehair bristles and a rubber tab making it highly efficient on carpet and hard surfaces. 10' cord, lightweight 6lb

Sanitaire



SC3683B
 Mighty Mite
 At 10 lbs and less than 20" long, this canister can get into hard to reach places where almost no other cleaner can go. 2.6 gal capacity, 10 amps, 20' cord, 10" cleaning path.
 60666B - Filter
 60295B-6 - Dust Bags 3/pk



ProTeam Proguard 4 Portable Wet/Dry Vac

107128

For emergency spills, detail cleaning and portable jobsite maintenance, there's no better choice for true wet/dry vacuum performance in an easy-to-carry package. 4 gal capacity.

107182 - Dust Bags 3/pk
 107178 - Dust Filter



An ergonomic solution for greater efficiency, higher production and safety!
 Use with ProTeam backpack or canister vacs.



ProBlade Carpet Tool Kit

107530

Improved ergonomics, more intuitive setup, boosts efficiency & worker satisfaction. Incl.: 14" ProBlade Carpet Floor Tool, Straight Telescoping Wand, 17" Crevice Tool, 3" Dusting Brush, 5" Upholstery Tool



ProBlade Carpet & Hard Surface Tool Kit

107532

Improved ergonomics, more intuitive setup, boosts efficiency and worker satisfaction. Incl.: 14" ProBlade Carpet and 14" Hard Surface Floor Tool, Straight Telescoping Wand, 17" Crevice Tool, 3" Dusting Brush, 5" Upholstery Tool



Upright Vacuum

New!



Bissell ProBag

BGU1451T

Motor 10 amp
 Container Dust Bag
 Cleaning Path 13"
 Cord Length 30'
 Warranty 1 Year
[U1451PK25 - Dust Bags 25/pk](#)



New!



Eon QuietClean

SC5500A

Motor 10 amp
 Container Dust Bag
 Dust Capacity 3 dry qt.
 Cleaning Path 12"
 Cord Length 40'
 Warranty 1 Year
[68104 - Dust Bags 5/pk](#)



HEPA Heavy Duty Applications

SC5815D

Motor 10 amp
 Container Dust Bag
 Dust Cap. 4.5 dry qt.
 Cleaning Path 15"
 Cord Length 40'
 Hose 3:1 stretch
 Warranty 2 Years
[61840-1 - HEPA Washable Filter](#)
[61820 - Dust Bags 3/pk](#)



HEPA Dirt Cup

SC5845B

Motor 10 amp
 Container Dirt Cup
 Dust Capacity 3.5 dry qt.
 Cleaning Path 15"
 Cord Length 40'
 Hose 3:1 Stretch
 Warranty 2 Years
[61840-1 - HEPA Washable Filter](#)



ProTeam ProGen 15 Upright Vacuum

107330

Added performance and features for cleaning professionals. A commercial upright with increased maneuverability and animated dashboard display. 3 level filtration with HEPA
 - 9.8A, 100CFM, 1100W
 - 8ft hose, 50ft cord
 - 3.25L capacity, 18lb
 - 15" Wide, c/w upholstery & crevice tools
[107377 - Dust Bags 12/pk](#)



BackVac

Dustbane Fast Track Back Vac

DB27100

CFM 152
 Water Lift 101"
 db Rating 67
 Cord Length 50'
 Capacity 1.5gal
 HP 1.5
 Amps 11.4
 Weight 9.8lbs

- Includes Standard Tool Kit
- Pivoting right and left handed hose
- Adj. straps, Cushioned antibacterial back-pad
- Integrated lumbar support



[DB27102 Dust Bags, 10/pk](#)

BackVac

ProTeam Super Coach Pro w/HEPA

107310 Pro6 6qt (6.6L)

107303 Pro10 10qt(11L)

Ergo comfort design, 4 level filtration
 Quiet only 66dBA
 Motor 9.5A
 Container Dust Bag
 Capacity 6.6L or 11L
 Clean Path 14"
 Cord Length 50'
 Weight 10lbs
 Includes 1-1/2" hose, 2 micro filters, 14" Xover floor tool, 42-59" wand, 17" crevice tool, 3" brush, 5" upholstery tool. 3yr+ warranty.
[107314 Dust bags Pro6, 10/pk](#)
[107313 Dust bags Pro10, 10/pk](#)



New!

BackVac

Betco Back Pack Vac

E8590300

CFM 120
 Water Lift 100"
 db Rating 66
 Cord Length 50'
 Capacity 1.25gal
 Amps 11.4
 Weight 10.6lbs

- Includes Multi-Task Tool Kit
- Lightweight and versatile design reduces operator fatigue.
- Quad filtration captures fine dust particles.
- Ergonomic backrest and onboard tool holder.



[DB27102 Dust Bags, 10/pk](#)



New!



90610B-12 3/pk
Central Vacuum bags. For Beam, Eureka, Kenmore, Kelvinator, Electrolux vacs



DB28501 330
DB28502 660/990
Dustbane Targa vacuum bags, 10/pkg.



107314 Pro 6 (6.6L)
107313 Pro 10 (11L)
ProTeam Backpack Vac Bags. Micro filter disposable dust bags.



70001 QS1/QS2 - 10/pk
Dustbane upright vacuum bags, micro filter

New!



391C 3/pk
Venmar Broan Nutone central vacuum bags.



103483 10/pk
Proteam intercept micro filter bags

New!



87-5300 10/pk
Windsor disposable vac bags



62370-10 10/pk
Eureka/Electrolux/Sanitaire Paper Bags "BV-2" Backpack Vac. (SC412)

New!



68104 5/pk
Sanitaire RL Premium vac bags.

New!



BA261 5/pk
Kenmore disposable vacuum bags.



10/37 3/pk
Type "A" Top Fill Paper Bags. Fits many brands.



80-7514888
Taski OEM
JAN-TABORA2-10
Non OEM
Taski Paper Bags. Large. Bora 12 & Vento 15 models. 10/pk



80-7514886 10/pk Taski OEM
Taski Paper Bags. Small. Baby Bora & Vento 8 models.



WI1802 10/pk
Windsor & Sebo sensor plastic collar micro, 3ply plastic collar.



BA875 12/pk
Panasonic Upright Bags. (U and U3 models)



BA232 5/pk
Carpet Pro Bags. Model VAC5000T

New!



CPP-3 3/pk
Sentry Bags III



JAN-CMPRO-10 10/pk
Janitized vacuum bags. For VAC5000T upright

New!



BA8146 5/pk
Ghibli AS6 paper vacuum bags.



XQC1002 10/pk
Microfiber bags for Quick Clean dry commercial canister vacuum, Fits VACD-CC200 OEM. H13 Filtration, 99.95% @ 0.3 Microns.

New!



3184 3/pk
Hoover PB WindTunnel paper vac bags.



shop-vac
906-61 4-6.5 Gal
906-62 8-11.5 Gal
906-63 13-18 Gal
Shop-Vac Disposable collector filter bags. For dust dirt and debris on models with side inlets only. 3/pk



shop-vac
906-71 4-6.5 Gal
906-72 8-11.5 Gal
906-73 13-18 Gal
Shop-Vac High efficiency disposable filter bags. Specially designed for pick up of fine debris like drywall dust etc. 2/pk.



DB27102
Dustbane Fast Track Back Vacuum Bags
10/pk. Fits: DB27100





DB28906 1-1/4"
Targa 330/Enviro
Floor Tool for Dustbane Targa
vacuums



DB29009 1-1/4"
Targa 330/Enviro
DB29008 1-1/2"
Targa 660/990
Eco Carpet Tool for Dustbane



80-7523260
Taski Floor Tool. For newer
style Vento 8 & 15. Wand sold
separate



80-8503460
Taski Floor Tool. For older
style Taski Bora Models.
Wand sold separate



62228-4 SC5845
63858 SC9180
Sanitaire/Electrolux/Eureka
brush rollers, 62228-3 shown.
Fits SC5845 and many other
models.



DB28999 1-1/4"
Dusting Brush for Dustbane
Targa vacuums. Must use
DB29003 reducer for Targa
660/990.



DB28997 1-1/4"
Crevice Tool for Dustbane
Targa vacuums. Must use
DB59003 reducer for Targa
660/990



DB29003 1-1/2" to 1-1/4"
Reducer for Dustbane Targa
vacuum accessories.



80-8503280
Taski Bora 12 Replacement
Hose. For older Bora 12
models only.



DB28993
Dustbane Targa Power
Nozzle Hose Assembly



DB26122
Dustbane Targa vacuum hose
cover. 10ft length. Fits models
Enviro, 330, 660 and 990.

Visit our
website for
installation
instructions



DB26172
Dustbane vacuum power-
head cable kit. For use with
DB28392 499 Power Nozzle.



XSS2046
Sebo PowerBrush agitator
brush strip



Part#	Len.	Model
DB26035	35ft	330/Enviro
DB26050	50ft	660/990

Dustbane Targa vacuum cord.



DB29004 Upper
DB29005 Lower
Dustbane powerhead replace-
ment wands.



DB28994 1-1/4"
Pistol Grip for Dustbane Targa
Enviro/330 vacuums.



61120 2/pk
Eureka/Sanitaire Bravo,
Victory Proline. EXT U. Fits
SC5815, SC5845



XS315
Carpet Pro Belt. 5/8"x8". Fits
model VAC5000T



BF140
Panasonic Flat Upright.
1/2"x7-11/16"



DB22306
Dustbane Targa vacuum castor
wheel. Fits models Enviro, 330,
660 and 990.

Filters



DB26018VG 330
DB26020VG 660/990
Air Clean Filters for Targa
vacuum models



shop-vac
901-07 3/pk
Shop vac filter for pick up of
larger debris and dry material.
Must be used in combination
with 905-85 foam sleeve.



shop-vac
903-04
Cartridge Filter for Wet or Dry
Pickup. Designed to combat
your toughest challenge, fits
most Shop-Vac® wet/dry Vacs.
Fits full size vacs.



shop-vac
903-9882
Small Cartridge Filter. Small,
dry debris. Fits Hang Up Vacs,
5 Gallon Contractor Portable,
Floormaster Plus, All Around
Plus, and Heavy Duty Portable.



68910
SC9180
Eureka/Electrolux/Sanitaire
Washable Hepa Filter



shop-vac
905-85
Use the Foam Sleeve for picking up wet
messes when used alone. The Foam Sleeve
is also required when using reusable disc
style filters. Required unless you are using a
cartridge filter.



shop-vac
903-40
Shop-Vac® with CleanStream® - Gore® HEPA
Cartridge Filter. Wet & dry pick-up. Maintains
suction power even when used with fine debris
like drywall dust!



Light to Medium Traffic

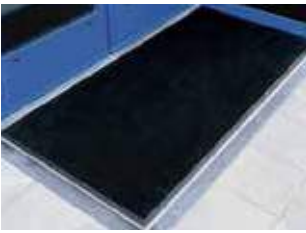

22 Black



11 BROWN



20 CHARCOAL

Medium to Heavy Traffic



10 CHOCOLATE



20 CHARCOAL

Medium to Heavy Traffic



22 Black



#1 choice for contractors and property managers.



Protect your carpets.

Gritstop Fingermat

Black	Size
GFM222432	24 in. x 32 in
GFM223239	32 in. x 39 in.
GFM223660	36 in. x 60 in.
GFM223672	36 in. x 72 in.

Over 2700 rubber finger/ft². Rubber Thickness 5/8". Total wt.70 lbs./ft.2 Super scraper fingers and containment well. Go after the worst in heavy soil and snow, complete with bevelled edging. *Custom sizes available. 5 year warranty*

Poly-Tuft

Brown	Charcoal	Size
PTF110203	PTF200203	2 ft. x 3 ft.
PTF110304	PTF200304	3 ft. x 4 ft.
PTF110305	PTF200305	3 ft. x 5 ft.
PTF110306	PTF200306	3 ft. x 6 ft.
PTF110310	PTF200310	3 ft. x 10 ft.
PTF110406	PTF200406	4 ft. x 6 ft.
PTF110408	PTF200408	4 ft. x 8 ft.
PTF110410	PTF200410	4 ft. x 10 ft.

Cut Pile, 100% Polypropylene, (PVC) Vinyl backing, Face wt.15 oz./yd.2 Total wt.70 lbs./ft.2. Roll width 3 ft., 4 ft. or 6 ft. +/.

Roll length 60 ft. (+/- 5%) Poly

Tuft is a solid value in a cut pile wiper mat. A "perennial favorite", complete with edging. *Custom sizes available. Other Colours available*

Herringbone

Chocolate	Charcoal	Size
HBN100304	HBN200304	3 ft. x 4 ft.
HBN100305	HBN200305	3 ft. x 5 ft.
HBN100306	HBN200306	3 ft. x 6 ft.
HBN100310	HBN200310	3 ft. x 10 ft.
HBN100406	HBN200406	4 ft. x 6 ft.
HBN100408	HBN200408	4 ft. x 8 ft.
HBN100410	HBN200410	4 ft. x 10 ft.

Needlepunch, 85% Polypropylene, (PVC) Vinyl backing

Face wt. 27 oz./yd.2, Total wt. 80 lbs./ft.2

Roll width 3 ft., 4 ft. or 6 ft. +/.

Roll length 60 ft. (+/- 5%)

Herringbone "V" pattern adds a dynamic look to an excellent wiper/scrapper mat, complete with edging. *Custom sizes available. Other Colours available*

Antifatigue Mat - Bubble Mat

Black	Size
BMI220203	2 ft. x 3 ft. Individual, wt 9lbs
BMI220304	3 ft. x 4 ft. Individual, wt 18lbsDomed Top (Solid).

Natural Rubber, 54% recycled, Eco Friendly, Linear connectors. Thickness 5/8". Includes an integrated bevelled edge, complete with bevelled edging affixed. *1 year warranty*

Carpet Mask

Clear	Size
CPM012135	21" x 35ft
CPM012120	21" x 200ft
CPM012420	24" x 200ft
CPM013620	36" x 200ft

Cost effective temporary protection for carpeted surfaces. Solvent based self adhesive (Use on synthetic carpet only). Easy to remove, skid resistant surface, 2mil.

Carpet Saver

Rubber	Size
BTT221632	16" x 32"

Inexpensive containment of water, snow melt, and soils. 3/4" Depth





No more mops or buckets!



Betco Motomop

#E847000

The Small Area Cleaning Machine

Cleans 4x faster than a mop and bucket, and is 38x more effective in picking up soils, when measured with an ATP test meter. Engineered design leaves the floor dry reducing the potential for costly slip and fall accidents. Versatile and compact features are perfect for schools, hospitals, retail or any institution that wants a better more cost-effective clean.



folds up for easy storage



Air Movers



E8550700

FibrePRO Air Mover

Smooth quiet & dependable operation. 0.5HP, 2500CFM, 3 speeds



107596

Air Mover. Powerful 2200CFM .4HP c/w handle kit for easy moving. 3 Speeds, 3 operating positions. 30ft poser cord. 28lbs. 3yr warranty.

shop-vac



1032000

Air Mover 3 Speed air control, built in outlets, 3 operating positions for drying carpets/floors, walls, and ceilings. 10' cord len. 500CFM, 1.5A

Don't forget

to login to see wholesale pricing
www.amresupply.com

Shopping Lists

Create and save re-usable shopping lists for your favourite products to make reordering a breeze! Bob's Plumbing Items, Lisa's Cleaning Supplies, Building A Maintenance Supplies, create and name as many lists as you want to stay organized and you can even share the lists with other users!

Most Popular Items

With a click of a button view the top items in your purchase history!

View Invoices, Backorders & Statements

Updated daily you can view and/or print invoices, backorders and account statements. Search by date, po#, part# or invoice # and follow eta's on your backorders.

Create & Manage Users

Add multiple users to your account and manage purchase limits, share shopping lists, review purchases and more...

On-line Payment Solutions



AMRE SUPPLY
Property Performance Centres
\$12.99 Flat-Rate Shipping to Provinces (Some Restrictions Apply)

Locations: Calgary, Edmonton, Hamilton, London, Richmond, Saskatoon, Scarborough, Surrey, Windsor, Winnipeg

Call Us Toll-Free: 1-800-661-9891

Navigation: HOME, LOCATIONS, BRANDS, ABOUT US, NEWS, CAREERS, MSDS FORMS, POLICIES, RETURNS, CREDIT APPS, CONTACT, LOGIN

Search: Product Search, Product #, Keywords, or Bar Code, Model Search, Enter Model #, GO

Cart: 0 Items in Cart

Live Chat Support ONLINE Click Here for Help!

Keep your basement dry and your possessions safe! Test your sump pump:

Conventional and Ultra High Speed Pads

CONVENTIONAL PADS



- Emerald - Stripping**
Aggressive, heavy-duty pad for max wet stripping performance
- Black - Stripping**
Aggressive, heavy-duty wet stripping pad
- Green - Stripping**
Heavy-duty deep scrubbing pad. For Scrub and recoat applications
- Blue - Cleaner**
Moderate scrubbing pad for recoat or light spray floor cleaning
- Red - Buffing**
Conventional, multi-purpose pad for wet and dry buffing and light scrubbing
- White - Super Polish**
Non-aggressive pad for polishing clean, dry floors
- Thin Maroon - DRY STRIPPING PAD**
Aggressive pad designed for stripping floor finish. The fibers are coated with a high-quality abrasive for a fast, efficient job.

ULTRA HIGH SPEED PADS



- Blue Ice**
Super soft for dry burnishing, for deep and lasting shine
- Hair Blend Light**
Combines natural hair and fiber in an advanced way, bringing out the gloss on softer, more buffable floor finish
- Hair Blend Heavy**
Blend of synthetic fibers and natural hair. Pads last longer
- Hair Blend Extra Heavy**
Made of animal hair, with a hard and aggressive binder
- Eraser**
Restores finishes and improves gloss on hard floor surfaces. Removes marks and scuffs quickly with minimal finish removal. Exhibits excellent durability



Conventional

	Emerald	Black	Green	Blue	Red	White	Thin Maroon
10"	-	DB42005	DB42051	DB42074	DB42097	DB42143	DB42823
11"	-	DB42006	DB42052	DB42075	DB42098	DB42144	DB42824
12"	DB42317	DB42007	DB42053	DB42076	DB42099	DB42145	DB42825
13"	DB42318	DB42008	DB42054	DB42077	DB42100	DB42146	DB42826
14"	DB42319	DB42009	DB42055	DB42078	DB42101	DB42147	DB42827
15"	DB42320	DB42010	DB42056	DB42079	DB42102	DB42148	DB42828
16"	DB42321	DB42011	DB42057	DB42080	DB42103	DB42149	DB42829
17"	DB42322	DB42012	DB42058	DB42081	DB42104	DB42150	DB42830
18"	DB42323	DB42013	DB42059	DB42082	DB42105	DB42151	DB42831
19"	DB42324	DB42014	DB42060	DB42083	DB42106	DB42152	DB42832
20"	DB42325	DB42015	DB42061	DB42084	DB42107	DB42153	DB42833
21"	DB42326	DB42016	DB42062	DB42085	DB42108	DB42154	DB42834
22"	-	DB42017	DB42063	DB42086	DB42109	DB42155	DB42835

Ultra High Speed

	Blue Ice	Hair Blend Light	Hair Blend Heavy	Hair Blend Extra Heavy	Eraser
17"	DB42408	-	DB42284	DB42301	DB42447
18"	DB42409	-	DB42281	DB42302	DB42448
19"	DB42410	DB42344	DB42286	DB42303	DB42449
20"	DB42411	DB42345	DB42287	DB42304	DB42450
21"	DB42412	DB42346	DB42288	DB42305	DB42451
22"	DB42804	-	DB42289	DB42306	DB42452
24"	DB42413	DB42348	DB42291	DB42308	DB42454
27" 1/4"	-	DB42339	DB42337	DB42309	DB42455
27" 3-1/4"	DB42414	DB42353	-	DB42338	DB42456

Please contact our Customer Care Team for other sizes and styles that are quickly available

PH: 1.800.661.9891
customer@amresupply.com





Auto Scrubber



BETCO

E8303900 Genie B Auto Scrubber

Genie B brings the benefits of automatic scrubbing to small and congested areas that are hard to clean with traditional equipment. Battery operated and compact this machine can virtually replace the mop and bucket to provide more effective and efficient cleaning.

Floor Machine



BETCO

E8301007 Foreman 20DS

Dual Speed Floor Machine
Betco floor machines are engineered for easy use rugged durability and long lasting reliability. Each model comes standard with a heavy duty 1.5HP motor to take on all cleaning jobs from scrubbing to stripping or carpet bonnet cleaning.

Floor Machine



DB19918 Integra TX UHS

Creates a brilliant gloss surface. The result is a spotlessly clean floor which leaves even small areas looking clean and bright.



Call us for a huge selection of floor machines!

SPECS:

	Genie B Autoscrubber E8303900	Foreman 20DS E8301007	TX UHS DB19918
Productivity	11,300 sq.ft/hr (1050sq.m/hr)	2,400 sq.ft/hr 730sq.m/hr	3,000 sq.ft/hr 914sq.m/hr
Scrubbing Width	14" (35cm)	20" (51cm)	20" (51cm)
Squeegee Width	17" (44cm)	-	2000RPM
Number of Brushes	1 x 14" (1 x 35cm)	1 x 20" 1 x 51cm	1 x 20" 1 x 51cm
Brush / Pad Speed	140RPM	175-300RPM	2000RPM
Brush Motor Power	1/3HP	1.5HP	1.5HP
Water Lift (Squeegee)	45"	-	-
Solution Tank Cap	3 Gal (11L)	-	-
Recovery Tank Cap	3 Gal (11L)	-	-
Power Supply	1 x 12V	120V Corded	115V Corded



Auto Scrubbers



E2993500

Stealth ASD20B - Walk Behind Auto Scrubber

New and innovative design with an extreme noise reduction system to make this the most quiet machine in it's class. The brush assist traction reduces operator fatigue and increases productivity.



E2996200

Stealth DRS21BT MicroRider Auto Scrubber

From the pioneers in Stealth cleaning technology, Betco's latest innovation lowers cleaning costs by 36% and delivers the quietest machine ever! Operating at only 54 dBA, the Stealth MicroRider makes day cleaning a reality, only faster and more cost effective than ever before.



E2993600

Crewman AS20B- Auto Scrubber

The Crewman™ auto scrubber is a unique combination that brings a lot of value while helping you spend money wisely. When looking for you next scrubber, the Crewman is a simple, reliable, affordable machine for your facility.



DB19362-C-AGM Hurricane 450XTT

An innovative design that ensures maximum productivity within the most compact size possible.



SPECS:

	Stealth ASD20B E2993500	Stealth DRS21BT E2996200	Crewman AS20B E2993600	Hurricane 450XTT DB19362 -C-AGM
Productivity	20,000 sq.ft/hr (1858sq.m/hr)	31,000 sq.ft/hr (2880sq.m/hr)	15,000 sq.ft/hr (1393sq.m/hr)	18,836 sq.ft/hr (1750 sq.m/hr)
Scrubbing Width	20" (51cm)	21" (53cm)	20" (51cm)	20" (51cm)
Squeegee Width	30" (76cm)	28" (71cm)	26" (66cm)	24" (61cm)
Number of Brushes	1 x 20" (1 x 51cm)	1 x 21" (1 x 53cm)	1 x 20" (1 x 51cm)	1 x 20" (1 x 51cm)
Brush / Pad Speed	140RPM	140RPM	140RPM	140RPM
Brush Motor Power	1 x 0.55HP	1 x 0.60HP	1/2HP	350W
Motor Type	2-Stage (480W)	2-Stage (480W)	3-Stage (650W)	3-Stage (550W)
Water Lift at Squeegee	76" (193cm)	45"	45"	44" (112cm)
Solution Tank Capacity	10 Gal (40L)	17 Gal (65L)	9 Gal (34L)	11 Gal (40L)
Recovery Tank Cap.	13 Gal (50L)	20 Gal (75L)	11 Gal (42L)	12 Gal (45L)
Power Supply	2 x 12V	2 x 12V	2 x 12V	2 x 12V
Unit Size (LxWxH)	46" x 21" x 39" 116 x 53 x 99cm	52" x 26" x 47" 132 x 66 x 119cm	43" x 22" x 38" 109 x 55 x 96cm	22" x 33" x 48" (56 x 84 x 122cm)
Weight	154 lbs (70kg)	240 lbs (109kg)	200 lbs (91kg)	154 lbs (70kg)
Run Time	3 Hours	4 Hours	2.5 Hours	2 Hours
Noise Level	54 dB	54 dB	65 dB	68 dB





Auto Scrubbers



DB19366-C-AGM DB19368-C-AGM Hurricane Rally

The Hurricane Rally is designed to clean the areas that are inaccessible with larger riders. It is small and easily maneuverable, but yet offers a wide cleaning path for maximum productivity in your larger cleaning areas.



DB19326-C-AGM DB19328-C-AGM Hurricane 900XTT

Our largest scrubber for your bigger jobs. It is designed to tackle the most extreme washing project. It's equipped with a large capacity tank to keep you working longer and efficiently.



DB19360-C-AGM Hurricane 900XTT Cylindrical

Our largest scrubber for your bigger jobs. It is designed to tackle the most extreme washing project. It's equipped with a large capacity tank to keep you working longer and efficiently.



SPECS:

	Rally 21 DB19366-C-AGM	Rally 28 DB19368-C-AGM	900XTT 28" DB19326-C-AGM	900XTT (Cylin.) 30" DB19360-C-AGM	900XTT 36" DB19328-C-AGM
Productivity	34,229 sq.ft/hr (3180 sq.m/hr)	43,788 sq.ft/hr (4068 sq.m/hr)	49,514 sq.ft/hr (4600 sq.m/hr)	52,743 sq.ft/hr (4900 sq.m/hr)	64,584 sq.ft/hr (6000 sq.m/hr)
Scrubbing Width	21" (53cm)	28" (71cm)	28" (71cm)	30" (75cm)	36" (92cm)
Squeegee Width	28" (71cm)	37" (94cm)	33" (83cm)	40" (101cm)	43" (110cm)
Number of Brushes	1 x 21" (53cm)	2 x 14" (2 x 36cm)	2 x 14" (2 x 36cm)	2 x 6" Rollers (2 x 15cm)	2 x 18" (2 x 46cm)
Brush / Pad Speed	215RPM	285RPM	200RPM	1000RPM	200RPM
Brush Motor Power	400W	2 x 400W	2 x 400W	1 x 1000W	2 x 500W
Motor Type	2-Stage (480W)	3-Stage (550W)	3-Stage (650W)	3-Stage (650W)	3-Stage (650W)
Water Lift at Squeegee	48" (122cm)	48" (122cm)	65" (165cm)	65" (165cm)	65" (165cm)
Traction Motor	Yes	Yes	Yes	Yes	Yes
Solution Tank Capacity	21 Gal (80L)	21 Gal (80L)	38 Gal (145L)	38 Gal (145L)	38 Gal (145L)
Recovery Tank Cap.	22 Gal (83L)	22 Gal (83L)	45 Gal (170L)	45 Gal (170L)	45 Gal (170L)
Power Supply	4 x 6V	4 x 6V	6 x 6V	6 x 6V	6 x 6V
Maximum Speed	6 km/hr	6 km/hr	6 km/hr	6 km/hr	6 km/hr
Unit Size (LxWxH)	52" x 26" x 41" (132 x 66 x 104cm)	52" x 26" x 41" (132 x 66 x 104cm)	68" x 33" x 54" (173 x 84 x 137cm)	68" x 35" x 54" (173 x 89 x 137cm)	77" x 46" x 58" (196 x 117 x 147cm)
Weight	260 lbs (118kg)	401 lbs (182kg)	838 lbs (380kg)	838 lbs (380kg)	838 lbs (380kg)
Run Time	3.5-4 Hours	3.5-4 Hours	5 Hours	5 Hours	5 Hours
Noise Level	65 dB	65 dB	70 dB	70 dB	70 dB



Extractor

Esteam Ninja Extractors

Save Time. Money. Hassles. Headaches.

Put The Industry's Leading Portable Extractor To Work For You!

Leading the pack, the Esteam CSA-US approved NINJA CLASSIC™ portable extractors offer convenience and reliability like no other. *Rely on the world's most popular extractors to save you time and money!*

Ninja Classic Portable Extractors

- #EST-NJA150 150PSI
- #EST-NJA150-10 150PSI With Heater
- #EST-NJA200 200PSI
- #EST-NJA200-10 200PSI With Heater
- #EST-NJA500 500PSI
- #EST-NJA500-10 500PSI With Heater



40 Litre (10 Gallon) Solution and 40 Litre (10 Gallon) Recovery Capacity: allows for maximum efficiency in time and labour costs, allowing you to work longer without any downtime. The dual 2-stage motor is hooked up in series to give you great airflow and sealed suction. Models with heater include 1850 watt/200 °F heater.

Tools



#EST-250-008
1-1/2" Dual Jet S-Bend Wand



#EST-255-080
3" Hand Tool



#EST-260-038-25
Vacuum Hose With Cuffs
1-1/2" x 25'



#EST-261-042-25
Solution Hose With Quick Connect
1/4" x 25'



E8730300

FiberPro 20 - Self-Contained Extractor

Highly productive, professional carpet cleaning. Sleek simply design with a large 20 gallon capacity you achieve maximum productivity in large areas. Ergonomically designed handle, quick-change spray jets, high performance vacuum shoe and self propelled variable speed.



DB19384

Power Clean 900XT

Operator-friendly control panel makes it easy to operate. The Power Clean 900XT's easy glide vacuum shoe moves across the carpet effortlessly



Steam Cleaner

Cleaning with the Magic Vapor is almost like...magic!

MAGVAPSYS

Intersteam Magic Vapor Steam Cleaning System

Easily melt grease, remove dirt and deep clean surfaces with this super powerful steam cleaner. A unique construction featuring a copper boiler and external heating bands takes the heating power of this machine to the max. Includes complete accessory package



CHECK OUT OUR WEBSITE www.amresupply.com for our FULL SELECTION OF CEILING FANS

30" 6 Blade - Twister



Brushed Pewter

PART# **COLOUR** **REVERSE BLADES**
CF3230651S Brushed Pewter white or grey
CF3230611S White white or bleached oak
 Hugger mount, 1 X 60W, 30", 6 blade, Twister - complete with globe light kit

42" 4 Blade - Neptune Hugger



Brushed Nickel



Oil Bronze

PART# **COLOUR** **REVERSE BLADES**
CF15542411S White white or bleached oak
CF42NEP4BN Brushed Nickel maple or cherry
CF42NEP4ORB Oil Bronze walnut or medium
 Hugger Mount, c/w schoolhouse globe light kit, max. 1 X 60W medium base bulb (not included).

42" 5 Blade - Tradition / Seymour



pine/white blades, alabaster glass

Oil Rubbed Bronze - w/beaded glass

PART# **COLOUR** **REVERSE BLADES**
CF42TRA5ORB Oil Rubbed Brz. walnut or natural oak
CF42SEY5WH White pine or white blades
 Dual mount, c/w light kit. Bulb: 3 x 60W

42" 5 Blade - Rue



Cherry blades - w/flat opal glass



PART# **COLOUR** **REVERSE BLADES**
CF42RUE5BN Brushed Nickel Walnut or Cherry
 Dual mount, 3 x 60W, flat opal glass

42" 4 Blade - Catalyst VI



Brushed Pewter

White

Best Sellers

PART# **COLOUR** **REVERSE BLADES** **# BLADES**
CATALYST VI White white only 4
CATALYSTII Brsh. Pewter white or grey 5
 Dual mount, 3 X 50W, PAR20 OR R20, remote control adaptable, 42", c/w ring head light kit.

42" 5 Blade - Eclipse



Brushed Pewter

PART# **COLOUR** **REVERSE BLADES**
CF9042551S Brushed Pewter bleached oak or white
 Dual mount, 2 X 60W, remote control adaptable, 42", 5 blade - Eclipse, complete with single dome glass light kit

42" 5 Blade - Omni



PART# **COLOUR** **REVERSE BLADES**
CF10242551S Brushed Pewter gray/white
 Frosted Swirl Glass Light Kit. Dual Mount, remote control adaptable. Requires 3 x 50W R20 medium base lamps

42" 5 Blade - Rex



Walnut/Cherry blades - Brushed Nickel



PART# **COLOUR** **REVERSE BLADES**
CF42REX5ORB Oil Bronze Walnut/Med Oak
CF42REX5BN Brush Nickel Walnut/Cherry
 Dual mount, Flat opal glass, LED 15W 1000 Lumens 3000K, 25,000hr, dimmable

BEST VALUE



Swirl Glass, 11"D x 4-3/4"H, 2/A/40W
IFM211-WH white
IFM211-BPT br. pewter
 13"D x 4-7/8"H, 2/A/60W
IFM213-WH white
IFM213-BPT br. pewter
2/pk Swirl Glass
IFM211T-BPT
IFM211T-WH
 11"D x 4-3/4"H ceiling fixtures, 1/A/75W

Available in LED!



Melon Glass
 11"D x 4-3/8"H, 2/A/40W
625021WH white
625021PTR pewter
 13"D x 5"H, 2/A/60W
635022WH white
635022PTR pewter
 15"D x 5-1/4"H, 2, 2/A/60W
635023WH white
635023PTR pewter

Available in LED!



Alabaster (Marble) Glass
 11"D x 4-5/8"H, 2/A/40W
625031WH white
625031PTR pewter
 13"D x 5"H, 2/A/60W
635032WH white
635032PTR pewter

Available in LED!

PRO PICK



680112MB-PTR 680116MB-WH

All Fixtures come with Marbled Glass
 12-1/4"D x 4"H - 2/A/60W 16"D x 4-7/8"H - 3/A/60W 20"D x 5-3/4"H - 4/A/60W

Size	Pewter	White
12"	680112MB-PTR	680112MB-WH
16"	680116MB-PTR	680116MB-WH
20"	680120MB-PTR	680120MB-WH
12"	L680112MP010A1	12W LED/1140lumen/3000K
16"	L680116MP016A1	16W LED/1520lumen/3000K

Check your local government incentive programs for energy saving rebates!

Twin Pack

BEST VALUE



IFM1612T-BPT 2/pk
 Alabaster Glass 12"D x 4-1/2"H, 2/A/60W, Brushed pewter, clip light

Available in LED!



Satin White Glass
 12"D x 3-3/8"H, 2/A/40W
612392BN Brsh. Nickel
612392CH Chrome
 15-1/4"D x 4-1/8"H, 2/A/60W
612394BN Brsh. Nickel
612394CH Chrome

Available in LED!



Mushroom Light
810208WH
810208PTR
810208PB
 7-1/2"D x 4-3/4"H
 1 x 60W/A19
810210WH
810210PTR
810210PB
 9-1/2"D x 5"H.
 1 x 100W/A19

Dual Mount Options, Adapter Included



Part # Colour Lumen
62-962 3000K 820
62-963 4000K 860
62-964 5000K 950

LED Utility Fixture
 7-5/8"D x 3-3/4"H, White, 50,000 HR, 13.5W LED, Dimmable, 65W equivalent



IFM9213BPT
 Brushed Pewter with Alabaster Glass
 2/A/15/60W
 12-3/4"D x 4-1/2"H



Easy Install, mounts directly to 3/4" junction boxes



Blink Slim Series LED Flush Fixtures

3000K, 50,000 hrs, 5yr warranty, die cast aluminum, damp location rated, dimmable with compatible dimmers, 120-277V, 90CRI, Only 1/2"H

7" 12W/960 Lumen

- S9882 White
- S9883 Brush Nickel

9" 16W/1300 Lumen

- S9886 White
- S9887 Brush Nickel

Other colours available



Extra High Lumen Output!



L.E.D. Disk Light. Acrylic Lens

11"D x 1"H, 35,000hr, 3000K, **22W**, 1540 Lumen

- LED-SM11DL-BN-C Brush Nickel
- LED-SM11DL-WT-C White

"22 WATTS"

15"D x 1"H, 35,000hr, 3000K, **30W**, 2100 Lumen

- LED-SM15DL-BN-C Brush Nickel
- LED-SM15DL-WT-C White

"30 WATTS"



LED Blink Series

13"D x 1"H, Dimmable 25W, 1180 Lumens, 3000K, 40,000 HR

- S9650 White
- S9651 Brushed Nickel

LFM102A13BN

Brushed Nickel with Acrylic Lens
12-1/2"D x 3"H, 3000K,
18W/1300 Lumens/36,000 Hours



L614573CH010A1 Pol. Chrome

L614573BN010A1 Brushed Nickel

Square fixture with frosted glass. 9"W x 9"L x 3"H, 3000K, 12W LED, 1140 lumens.



- L612314BN010A1 Brushed Nickel 12Watt
- L612314CH010A1 Chrome 12Watt
- L612314BN016A1 Brushed Nickel 16Watt
- L612314CH016A1 Chrome 16Watt

LED Ceiling light with satin white glass. 3000K, 11"Dia x 3-1/4"H



Part #	Dia.	Watt	Lumens
L650900BN010A1	12"	12	1140
L650901BN016A1	13"	16	1520
L650901BN024A1	13"	24	2280
L650902BN024A1	15"	24	2280
L650902BN031A1	15"	33	3135

Brush Nickel steel trim with white acrylic lens. 12" and 13" are 3-1/2"H, 15-1/4" is 4-1/4"H, 3000K



Available in LED!



11" Diameter (3-3/8"H)
CFL 13W TT Lamp

- 650100-113 1/13WTT
- 650100-213 2/13WTT

650100-G Lens Only

14" Diameter (3-3/8"H)
CFL 13W TT Lamp

- 650102-213 2/13WTT

650102-G Lens Only

Also available in GU24 CFL version



Available in LED!



11" Diameter (3-1/2"H)
CFL 13W TT Lamp

- 650200-113WH 1/13WTT
- 650200-213WH 2/13WTT

650200-G Lens Only

13-3/4" Diameter (3-1/2"H)
CFL 13W TT Lamp

- 650202-213WH 2/13WTT

650202-G Lens Only

Also available in GU24 CFL version



Best Sellers



Finally the LED light all commercial properties have been waiting for...



Round

Order #	Color Temp K	Initial Lumens
<u>6" - 10 Watt</u>		
64154	3000	600
64155	4000	600
<u>8" - 12 Watt</u>		
64156-STD	3000	800
64157	4000	800
<u>11" - 15 Watt</u>		
65598	2700	1050
63298	3000	1050
63299	4000	1000
<u>14" - 25 Watt</u>		
65599	2700	1700
63302	3000	1700
63303	4000	1650
<u>16" - 26 Watt</u>		
65665	3000	2000
65666	4000	2100

Also available in 18", 20" and 22"

Round with brush nickel trim

Order #	Color Temp K	Initial Lumens
<u>6" - 10 Watt</u>		
64247	3000	550
64248	4000	550
<u>8" - 12 Watt</u>		
64249	3000	750
64250	4000	750
<u>11" - 15 Watt</u>		
64095	3000	1200
64096	4000	1200
<u>14" - 25 Watt</u>		
64099	3000	2000
64100	4000	2000

Round with double brush nickel trim

Order #	Color Temp K	Initial Lumens
<u>12" - 20 Watt</u>		
65605	3000	1525
65606	4000	1531
<u>14" - 25 Watt</u>		
65607	3000	1875
65608	4000	1931
<u>16" - 26 Watt</u>		
65611	3000	2000
65612	4000	2200

Square

Order #	Color Temp K	Initial Lumens
<u>11" - 15 Watt</u>		
63300	3000	1050
63301	4000	1000
<u>14" - 25 Watt</u>		
63304	3000	1700
63305	4000	1650



Tri-level Dimming Technology to Maximize Energy Savings

- 65723**
- Fully programmable to customize a perfect solution
 - Daylight sensor
 - Adjustable hold-time
 - Adj. detection area
 - Stand by dimming level and period
 - 4000K, 50,000hrs, 120v, 80CRI, 1020 lumens



Perfect solution for areas that require light 24hrs a day

All above fixtures include a tough frosted acrylic lens that can withstand most abuse. Sleek design will match almost any decor.

120v, 60hz, 50,000hr rated, 80CRI, dimmable.

These quality LED commercial rated fixtures are the perfect solution for hallways, stairways, walls, bedrooms and much more.

Compatible with Round 11" 65598 series or 14" 65599 series traditional ceiling luminaires.

Shades

12"	15"	Colours
65681	65688	Linen/White
65682	65689	Linen/Beige
65683	65690	Linen/Black
65684	65691	Linen/Gray
65685	65692	Wood/Natural
65686	65693	Cork/Natural
65687	65694	Silk/Frosted white
66044	66045	Barn Wood/Natural





Surface Mount

LED DOWNLIGHT - AVG. LIFE: 50,000 - DIMMABLE - Surface Mounted

PART#	WATTS	COLOUR	LUMENS	SIZE	TRIM
LED-SM4D-WT-C	12	3000	900	4"	White
LED-SM4D-BN-C	12	3000	900	4"	Brushed Nickel
LED-SM6D-WT-C	15	3000	1095	6"	White
LED-SM6D-BN-C	15	3000	1095	6"	Brushed Nickel

Adapts to any existing electrical box.



LED DOWNLIGHT - Wall or Ceiling Surface Mount

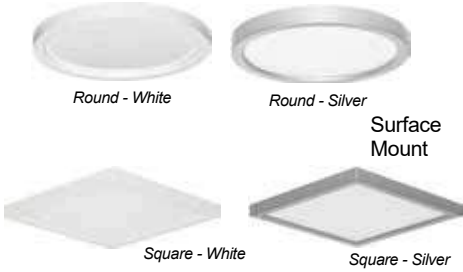

Surface Mount

PART#	WATTS	COLOUR	LUMENS	SIZE	TRIM
LED-SM55DL-WT-C	12W	White	660	5.5"	Round
LED-SM55DL-BN-C	12W	Brush Nickel	660	5.5"	Round
LED-SM7DL-WT-C	15W	White	850	7"	Round
LED-SM7DL-BN-C	15W	Brush Nickel	850	7"	Round
LED-SM63DL-WT-C	13W	White	720	5.5"	Square
LED-SM63DL-BN-C	13W	Brush Nickel	720	5.5"	Square
LED-SM8DL-WT-C	18W	White	1000	7"	Square
LED-SM8DL-BN-C	18W	Brush Nickel	1000	7"	Square

Low profile flushmount LED downlights. 3000K color, 35,000hr, 5yr warranty, dimmable, acrylic lens. Also available in ORB



GREAT Deal! 2/pk

Downlight Retro-fit

LED DOWNLIGHT - AVG. LIFE: 25,000 - DIMMABLE - Recessed Mounted



PART#	WATTS	COLOUR	LUMENS	SIZE DIA.	TRIM
S9598	8.5	2700	510	5-1/8"	White
S9599	12	2700	800	7-1/2"	White

Adapts to any existing recessed can. Adj. length 3-13/16" - 5-3/8" for 4" and 4-1/2" - 6-5/16" for 6"



4" & 6" Downlight Kits

- Easily converts most 4", 5" and 6" recessed downlights into more energy efficient solutions**
- Quick and easy installation
- IC rated when used in an approved IC rated recessed housing
- Suitable for use in damp locations



6" Downlight

The look of traditional recessed lights at a fraction of the energy and maintenance costs

LED DOWNLIGHT - 120V - DIMMABLE - Energy Star Qualified

NOW BRIGHTER!

PART#	SIZE	WATTS	BASE	COLOUR	AVG HRS.	CRI	INITIAL LUMENS	WATT EQU.
63641	4"	10	E26	2700	40,000	82	682	50
63644	4"	10	E26	3000	40,000	83	684	50
63647	4"	10	E26	4000	40,000	88	723	50
63650	6"	12.5	E26	2700	40,000	82	800	65
63653	6"	12.5	E26	3000	40,000	84	809	65
63656	6"	12.5	E26	4000	40,000	83	853	65

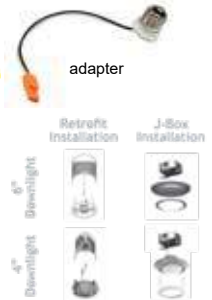

DOWNLIGHT LOW PROFILE - 120V, CRI 80, DIMMABLE

PART#	DESCRIPTION	SIZE	SHAPE	WATTS	COL. TEMP	COLOUR	AVG HRS.	INITIAL LUMENS
63891	LPDL4/SQR/9W/30K/WH/STD	4"	SQ.	9	3000	WHITE	40 000	530
63893	LPDL4/SQR/9W/30K/SLV/STD	4"	SQ.	9	3000	BRUSH. ALU.	40 000	530
65936	LPDL4/S2/RND/9W/27K/WH/STD	4"	RD.	9	2700	WHITE	50 000	520
65937	LPDL4/S2/RND/9W/30K/WH/STD	4"	RD.	9	3000	WHITE	50 000	550
65938	LPDL4/S2/RND/9W/30K/BN/STD	4"	RD.	9	3000	BRUSH. ALU.	50 000	550
65941	LPDL4/S2/RND/9W/40K/BN/STD	4"	RD.	9	4000	BRUSH. ALU.	50 000	580
65946	LPDL6/S2/RND/12W/30K/WH/STD	6"	RD.	12	3000	WHITE	50 000	780
65947	LPDL6/S2/RND/12W/40K/WH/STD	6"	RD.	12	4000	WHITE	50 000	800
63866	LPDL6/RND/12W/30K/SLV/STD	6"	RD.	12	3000	BR. NICKEL	40 000	780
63869	LPDL6/RND/12W/40K/SLV/STD	6"	RD.	12	4000	BR. NICKEL	40 000	820



These low profile downlights are perfect for all types of small spaces and suitable for almost any residential or commercial indoor lighting applications.

- Great for limited ceiling space as they are only 1" thick
- Easy installation, excellent light output
- 5yr Warranty, Dimmable, 120V, 40,000 HR rated, 80CRI



Semi Flush



Marbled Glass
15"D x 9-7/8"H
3/A/100W
660480PT
660480ORB



Chrome with White Fabric Shade
& Glass Diffuser
3 1/4"H X 15"W
20W/1200 Lumens
25,000 Hours
LFM101A13CH



New!



Brushed Nickel with Off-White
Shade & Acrylic Lens
14"D x 8-1/2"H
3/A/60W
613048BN



Brushed Nickel with
Frosted White Glass
13"D X 9-1/4"H
2/GU24/23W **Lamp Inc.**
ES601322BN



Pendant



Faux Glass
16"D X 11"H
1/A/100W
811871PT



Faux Glass
18"D X 12-1/2"H
1/A/100W
811870PTR



Pendant
15-5/8"D X 8-1/2"H
1/A/100W
805849WH



Save Money!
Don't miss out!
Energy Efficient
lighting!



Clear Ribbed Glass
17-1/2"D X 9-1/4"H
1/A/100W
811331WH



Rowan Pendant. Brushed Nickel
with Flat Opal Glass.
17-1/2"D X 14-1/2"H X 62-1/2"W
1/A/100W Medium base
IPL177B01BN18



Marble Glass
15"D X 18"H - 3/A/100W
811480PT
19-1/8"D X 19-1/2"H
811481PTR



Sussex Black Metal Pendant
12"D x 12-3/4" - 60-3/4"H, 12W/840
Lumens/25,000 Hours
LPL103A01BK



Polo Pendant. Brushed Nickel with
Painted White Interior. Requires
1/A/100W Medium Base
16"D X 14-1/2"W X 62-1/2"H
IPL222B01BN16 16"
IPL222B01BN18 18"



New!



Esma Pendant. Brushed Nickel
& Faux Wood with Painted White
Interior. Requires 1/A/100W
14"W x 12"-60"H
IPL449B01BNW



Juno Oil Rubbed Bronze Pendant,
Watermark Glass
5-1/2"D x 18-3/8" - 66-3/8"H,
12W/840
Lumens/25,000 Hours
LPL104A01ORB



Families



All Fixtures come with Marbled Glass

Pewter	Dimensions	Lamps
815116PTR	15-3/4" D X 22" H	3 X A19 Med. Base 60W
815120PTR	20" D X 21-1/4" H	3 X A19 Med. Base 100W



815120PTR

New Yorker Series



IWF256A01BPT



ISF256A03BPT



ICH256A03ORB



ICH256A05ORB



Brushed Pewter or Oil Rubbed Bronze Flat Opal Glass - Med Base

Brushed Pewter	Oil Rubbed Bronze	Dimensions	Lamps
IWF256A01BPT	IWF256A01ORB	8"H X 5"W X 7"E	1/A/60W
ISF256A03BPT	ISF256A03ORB	12"H X 15"W	3/A/100W
ICH256A03BPT	ICH256A03ORB	21"H x 18"W	3/A/100W
ICH256A05BPT	ICH256A05ORB	21-1/2"H X 21"W	5/A/100W

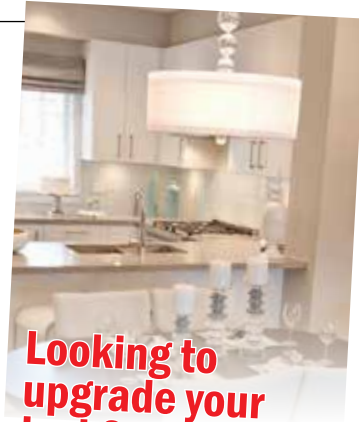

Looking to upgrade your look?
Call us today for a Reno quote and take advantage of great savings!

Crawford



IFM256A13BPT



ICH625A03BN



ICH625A05BN



IPL625A01BN



Brushed Nickel with flat opal glass - Med base

Part #	Dimensions	Lamp
IFM256A13BPT	13"W x 6"H	2/A/60W
ICH625A03BN	21"W x 22"H	3/A/100W
ICH625A05BN	23-1/2"W x 22"H	5/A/100W
IPL625A01BN	5"W x 17.5"-59.5"H	1/A/100W

Rue



IFM587A14BN



ISF587A02BN



IVL587A01BN



IVL587A02BN



IVL587A03BN



Brushed Nickel with Flat Opal Glass

Part #	Dimensions	Lamp
ICH587A05BN	24"H X 25"D	5 X 60W Med Base
ICH587A03BN17	24"H X 17"D	3 X 60W Med Base
ISF587A02BN	13"H X 15"D	2 X 60W Med Base
IPL587A01BN	12-1/5" - 60-1/5"H X 6-1/8"D	1 X 60W Med Base
IFM587A14BN	7"H X 13-3/4"D	2 X 60W Med Base
IVL587A01BN	7-1/2"H X 6"W X 7"E	1 X 60W Med Base
IVL587A02BN	8"H X 15"W X 6-1/2"E	2 X 100W Med Base
IVL587A03BN	8"H X 24"W X 6-1/2"E	3 X 100W Med Base



ICH587A05BN



ICH587A03BN17



IPL587A01BN

Ask us about government rebates available on many energy saving fixtures in some provinces.



Wall Hung

213140BN

1 x 100W Med Base

L213140BN012A1 12W LED

Satin white glass wall sconce with brushed nickel trim. 5-3/4"W x 11-3/4"H x 4"E. LED is 3000K, 1140 lumen.



213130BN 2 x 60W Med Base

L213130BN012A1 12W LED

Satin white glass wall sconce with brushed nickel trim. 8"W x 12"H x 4"E LED is 3000K, 1140 lumen.



L212430BN012A1

Brushed Nickel with Frosted Glass 10-1/4"W x 11-1/4"H x 4"E 12W / 3000K / 1140 Lumen



New!

Suitable for Outdoor Use!*
BZ and BK only

1 LIGHT

2 LIGHT

COLOUR

215670BN

215661BN

Brushed Nickel

215670BZ

215661BZ

Bronze

215670BK

215661BK

Black

With Satin White Cylinder Glass.

1 or 2/A15/60W

1 light 4-1/4"W x 9-3/4"H x 3-3/4"D

2 light 4-1/4"W x 15-1/4"H x 3-3/4"D

Brushed nickel indoor use only



211690BN 1 x 100W Med Base

L211690BN012A1 12W LED

Brush Nickel, frosted white glass 9"W x 12"H x 5"D 300K, 1140 lumen



208612PTR 1 x 100W Med Base

L2018612PT012A1 12W LED

12W/3000K/1140 Lumen

Faux Glass

12"W x 6-1/4"H x 3-3/4"D

LED is 3000K, 1140 lumens

Also Available in 16" and other colours.



250480PTR Pewter

250480ORB Bronze

Alabaster Style

13-1/2"W x 5"H x 6-3/4"D

1/A/100W



L219460CH

Polished Chrome with Etched Opal Glass, 3000K Dimmable 5"W x 13"H x 3-1/2"D, 10W LED, 800 Lumens



724131BN Brushed Nickel

724131CH Chrome

4-1/2"W X 8"H X 6-3/4"D

Barclay Collection

White Satin Glass. 1/A/100W.

Also available in Oil rubbed Bronze.



IWL92BPT

Brushed Pewter with

Alabaster Glass

12-1/2"W x 4-1/2"H x 6"D

1/A/100W



New!

Great for hotel guests

LWF141A01BK

Matte Black. 3000K with On/Off Switch. 4-3/8"W x 8"H x 15-3/4"D. 11.5W LED, 200 Lumens. 36,000 hours.



Renovating?

Renovating your hallways or common areas?

With a wide variety of manufacturers and hundreds of fixture choices, AMRE can help narrow down the search and save you money, call us for more information or a quote today!



Find a fixture you like? Convert it to LED easily! Contact AMRE for more details!



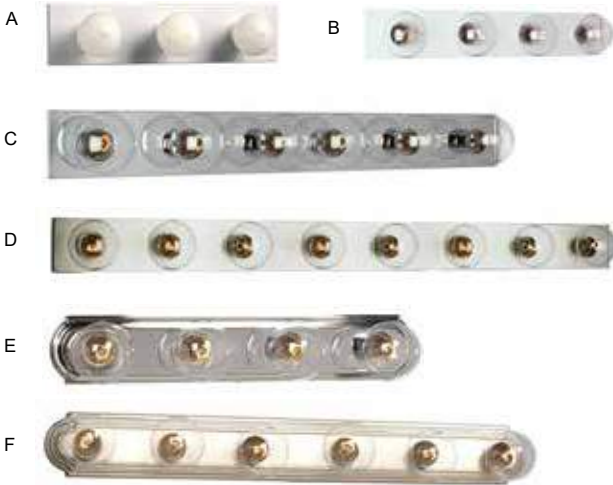

A. 18" Wide Vanity
3/60W
713618 Chrome
713200 White
713318 Pewter

E. 24" Round Vanity
4/60W
730624 Chrome
730224 White

B. 24" Wide Vanity
4/60W
714624 Chrome
714200 White
714324 Pewter

F. 36" Round Vanity
6/60W
730636 Chrome
700736 Pewter

C. 36" Wide Vanity
6/60W
716636 Chrome
716200 White
716336 Pewter

D. 48" Wide Vanity
8/60W
718648 Chrome
718200 White
718348 Pewter



Cydney LED Vanity Light
19"W x 4-3/8"H x 3-3/4"D
26.5W, 1600 Lumen, 3000K, 36,000hrs
LVL135A19BK Black
LVL135A19BN Br. Nickel
36"W x 4-3/8"H x 3-3/4"D
42W, 2368 Lumen, 3000K, 36,000hrs
LVL135A36BK Black
LVL135A36BN Br. Nickel



White Acrylic Lens
24-3/4"L X 6"H X 4-3/8"E
2 X 17W T8 - Fluorescent
EFV824217
36-3/4"L X 6"H X 4-3/8"E
2 X 25W T8 - Fluorescent
EFV836225
49-1/4"L X 6"H X 4-1/2"E
2 X 32W T8 - Fluorescent
ES921248BN



White Acrylic Lens
24-1/4"L X 6"H X 4-1/2"E
2x12W LED, 2280 Lumens, 3000K
L921224BN022A1*
24-3/4"L X 6"H X 4-3/8"
20W LED, 1700 Lumens, 3000K
LVL113A24BN
36-3/4"L X 6"H X 4-3/8"E
32W LED, 2400 Lumens, 3000K
LVL113A36BN
36-1/4"L X 6"H X 4-1/4"E
3x12W LED, 3420 Lumens, 3000K
L921236BN033A1*
49-1/4"L X 6"H X 4-1/2"E
4x12W LED, 4560 Lumens, 3000K
L921248BN044A1
(Also available in 3500K and dimming)
*Extra High Lumen Output!**



Locations Across Canada

Stop in one of our Amre store locations to see our great selection of products.

- | | | | | | |
|---|--|---|--|--|---|
| <p>Edmonton S
5020 - 75 St.
(780) 461-2929
Fax: 780-465-4271</p> | <p>EDMONTON D/T
MegaCenter
11413-120 St
(780) 426-2673
Fax: 780-784-1222</p> | <p>CALGARY
MegaCenter
#101, 5760 - 9th Street SE
(403) 243-6662
Fax: 403-243-9368</p> | <p>RICHMOND
MegaCenter
7671 Alderbridge Way
(604) 273-7377
Fax: 604-279-2310</p> | <p>Saskatoon
411A - 50th St. E.
(306) 955-2673
Fax: 306-955-3992</p> | <p>Surrey
#101, 5433 - 152 Street
(604) 575-9727
Fax: 604-575-5077</p> |
| <p>Winnipeg
1370 Sargent Ave.
(204) 775-8409
Fax: 204-786-5718</p> | <p>Hamilton
16 Brockley Drive
(905) 560-2673
Fax: 905-560-2405</p> | <p>SCARBOROUGH
MegaCenter
2161 Midland Ave.
(416) 412-7278
Fax: 416-412-7890</p> | <p>London
1761 Oxford St. East
(519) 451-2300
Fax: 519-451-3361</p> | <p>Windsor
Unit 1, 5900 Rhodes Dr.
(519) 250-0000
Fax: 519-250-8621</p> | <p>MISSISSAUGA
MegaCenter
Unit 5-4800 Eastgate Parkway
(905) 625-1267</p> |





Geneva II Collection
 Brushed Nickel with Frosted Glass, 3000K
L710737BN022A1
 24-1/2"W x 3"H x 4"E
 2x12W, 2280 Lumens
L710738BN033A1
 36-3/8"W x 3"H x 4"E
 3x12W, 3420 Lumens



Omni Collection
 Frosted Checkered Glass, Pewter
L790505PT024A1
 24"W x 6-3/4"H x 4-3/8"E
 2 x 12W, 3000K, 2280 lumen
L790507PT036A1
 32-5/8"W x 6-3/4"H x 4-3/8"E
 3 x 12W, 3000K, 3420 lumen

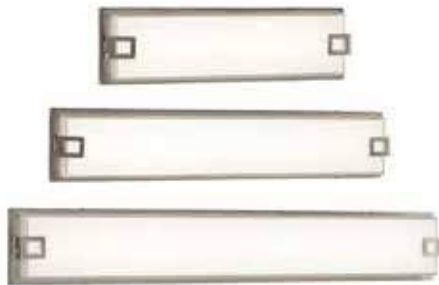

New!

Cyrus Collection
 Brushed Nickel with White Glass, 3000K Dimmable
L719452BN
 18-1/4"W x 5"H x 2-1/4"E, 20W LED, 1600 Lumens
L719453BN
 25"W x 5"H x 2-1/4"E, 37.5W LED, 3000 Lumens
L719454BN
 32-1/2"W x 5"H x 2-1/4"E, 47.5W LED, 3800 Lumens



Ambrose Collection
 Polished Chrome with Satin White Glass, 3000K Dimmable
L719461CH
 19-1/4"W x 4-1/2"H x 3-1/2"E, 20W LED, 1600 Lumens
L719462CH
 25-1/4"W x 4-1/2"H x 3-1/2"E, 37.5W LED, 3000 Lumens
L719463CH
 33-1/2"W x 4-1/2"H x 3-1/2"E, 47.5W LED, 3800 Lumens



Bryant Collection
 Chrome finish with acrylic lens, 41.5W, 2600 Lumens, 3000K,
 Dimmable, 36,000hr
LVL114A36CH 36"W x 4-3/8"H x 3-1/2"D



Brady Collection
 Chrome with acrylic lens, 3000K, Dimmable, 36,000hr
LVL115A18CH 18"W x 4-3/8"H x 4"D
 27W, 1620 Lumens
LVL115A36CH 36"W x 4-3/8"H x 4"D
 41.5W, 2600 Lumens



1000's of lights to choose from
www.amresupply.com



Full line distributor for: www.galaxy-lighting.com www.standardpro.com www.canarm.com



Don't forget to Login to see Wholesale Pricing!

- Wholesale Pricing
- Shopping Lists
- Create & Manage Users
- View Invoices, Backorders, & Statements



Crawford Collection
Brushed Nickel with flat opal glass

IVL625A02BN	2/A/100W
14"W x 8"H x 7-1/4"D	
IVL625A03BN	3/A/100W
22"W x 8"H x 7-1/4"D	
IVL625A04BN	4/A/100W
30-1/2"W x 8"H x 7-1/4"D	



Hampton Collection
Brushed Pewter with Painted Glass
Also Available in Chrome and Oil Rubbed Bronze.

Part #	Lamp
IVL370A02BPT	2/A/100W
18"W X 8-1/2"H X 6-1/2"E	
IVL370A03BPT	3/A/100W
24"W X 8-1/2"H X 7"E	
IVL370A04BPT	4/A/100W
32"W X 8-1/2"H X 7"E	



Adelaide Collection - Pewter
Faux Alabaster Frosted Glass

783002PTR	2/A/60W
18"W X 9-1/8"H X 8-3/4"E	
783003PTR	3/A/60W
24"W X 9-1/8"H X 8-3/4"E	
783004PTR	4/A/60W
30"W X 9-1/8"H X 8-3/4"E	



Belfast Collection
Faux Alabaster Frosted Glass

702606CH	2/A/60W	Chrome
702606BN	2/A/60W	Brsh Nickel
14"W X 7"H X 7"E		
703606CH	3/A/60W	Chrome
703606BN	3/A/60W	Brsh Nickel
24"W X 7"H X 7"E		



Barclay Collection
White Satin Glass.
Also available in Oil rubbed Bronze.

724131BN	1/A/100W	Brsh Nickel
724131CH	1/A/100W	Chrome
4-1/2"W X 8"H X 6-1/2"E		
724132BN	2/A/100W	Brsh Nickel
724132CH	2/A/100W	Chrome
14"W X 6-3/4"H X 6-1/2"E		
724133BN	3/A/100W	Brsh Nickel
724133CH	3/A/100W	Chrome
24"W X 6-3/4"H X 6-1/2"E		
724134BN	4/A/100W	Brsh Nickel
724134CH	4/A/100W	Chrome
30"W X 6-3/4"H X 6-1/2"E		



Chatham Collection
Chrome with Flat Opal Glass

IVL220A02CH	2/A/100W
13-3/4"W X 8-1/4"H x 7-1/4"E	
IVL220A03CH	3/A/100W
22"W X 8-1/4"H x 7-1/4"E	
IVL220A04CH	4/A/100W
30-1/2"W X 8-1/4"H x 7-1/4"E	





T8 Wrap around fixtures

Thermally protected electronic ballast also rated for cold temps. 2-1/2"D

EFW824217 24-3/4"L x 6-5/8"W, 2/F17W, T8, max. (sold sep.)

EFW848232 48-3/4"L x 6-5/8"W, 2/F32W T8 (sold sep.)

EFW848432 48-3/4"L x 10-3/4"W, 4/F32W, T8 max (sold sep.)



Why switch to LED?

Making the switch to LED fixtures and lamps offers **significant energy savings** over fluorescent tubes.

LEDs **contain no mercury** and use **less energy** to produce the same light output. LEDs long life means fewer bulb changes **saving you time and money.**



LED Wrap Fixture

4000K, 50,000 hrs, Non-Dimmable, Integrated LED, 5yr warranty, acrylic lens, 2-5/8" H

65-1081 24-1/4"L x 5-1/2"W 20W/1600 Lumens

65-1082 47-3/8"L x 5-1/2"W 40W/3200 Lumens



LED Wrap Fixture

4000K, 36,000 hrs, acrylic lens, Integrated LED, 82CRI, 2-1/2"H

LW12A19 24-1/4"L x 5-3/8"W 19W/1230 Lumens

LW14A40 46-5/8"L x 5-3/8"H 40W/2650 Lumens

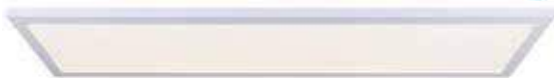

Perfect upgrade from traditional fluorescent for a modern look

Low Profile LED Flat Panels

4000K, 50,000 hrs, 80CRI, White with acrylic lens, Integrated LED, Dimmable with compatible dimmers, Surface, wire or recessed mount, 7/8"H

LPL22A48WH 23-3/4"L x 23-3/4"W 48W/3840 Lumens

LPL14A48WH 47-1/2"L x 12"W 53W/3840 Lumens

LPL24A58WH 47-1/2"L x 23-3/4"W 58W/4640 Lumens



LED Blink Series Low Profile Strip Lights

3000K, 50,000 hrs, 90+CRI, White, 5yr warranty, Dimmable with compatible dimmers, damp location rated, 120-277V, 3/4"H

62-1055 24"L x 5"W 22W/1600 Lumens

62-1056 36"L x 5"W 30W/2100 Lumens

62-1057 48"L x 5"W 40W/2800 Lumens



EFV848232C Brushed Nickel

48-1/2"L x 9-1/2"W x 4-1/4"H

2/F32W T8 max. (sold sep.)

Decorative fluorescent fixture will save energy and add a high end look for an economical price. Acrylic lens will not yellow.



T8 Fluorescent Cloud

White acrylic UV rated lens - will not yellow electronic thermally protected ballast (Bulb sold sep.)



EFU848232

50-1/2"L x 12-1/2"W 3-1/2"H

2/F32W T8 max.

EFU848432

50-3/4"L x 12-1/2"W x 3-1/2"H

4/F32W T8 max.



LED Cloud Light

4100K, 36,000 hrs, White acrylic lens, Dimmable, Integrated LED, 80CRI, 3-1/2"H

LU14A42 50-1/2"L x 12-1/2"W 42W/3100 Lumens

LU24A63 51-1/2"L x 18"W 63W/5000 Lumens



Perfect for Parking Garages



LED Vapour Fixture

5000K, 50,000 hrs, PC body and diffuser, Integrated LED, IP 65 damp location rated, 5yr warranty, corrosion proof.

47-7/8"W x 3-1/8"H x 4-5/8"H

LP848220-DB5K 40W/4200 Lumens

LP848230-DB5K 60W/6600 Lumens





T8 Troffers

Thermally protected electronic ballast, rated for cold temps.

EFR848232 4"D x 48"L x 11-5/8"W
2/F32W T8 max. (sold sep.)

replacement lens: RLFR8482

EFR848432 3-1/2"D x 48"L x 23-5/8"W
4/F32W T8 max. (sold sep.)



LED Shop Light

65032

Fully assembled, just plug in, no wiring required, pull-chain. 4000K, 40W, 4000 lumen high light output, 54,000hr
47-1/4"L x 5"W x 1-1/2"H



T8 Single strip lights. Thermally protected electronic ballast, reg. or side mounted (Bulb sold sep.). 3-1/8"D

FT8151 15"L x 2-3/4"W, 1/F14W T8orT12 max.

FT8181 18"L x 2-3/4"W, 1/F15W T8orT12 max.

EFT824117 24"L x 2-3/4"W, 1/F17W T8 max.

EFT836125 36"L x 2-3/4"W, 1/F25W T8 max.

EFT848132 48"L x 2-3/4"W, 1/F32W T8 max.



EFT896432TD



T8 Double strip lights. Thermally protected electronic ballast, rated for cold temperatures. 3-1/8"D

EFT824217 24"L x 4-1/2"W
2/F17W T8 max. (sold sep.)

EFT848232 48"L x 4-1/4"W
2/F32W T8 max. (sold sep.)

EFT896432TD 2/48"L x 4-1/4"W
4/F32W T8 max. (sold sep.)



LT848218-B4K

2x18W LED Lamps Included
48"L x 3-1/8"H x 4-1/4"D, 4000K, 3800 Lumen,
No ballast, 30,000hr



LED Striplights

4000K, 36,000hrs, Dimmable, White acrylic lens, Linkable (connector included) On/Off switch, Integrated LED.

LT11A12 12-3/8"L 12.5W/1000 Lumens

LT12A20 23-3/4"L 20W/1700 Lumens

LT14A24 46-1/2"L 26W/2500 Lumens

LT14A37 46-1/2"L 40.5W/3500 Lumens



*Huge lumen output
and long life*



LED LSS Series Striplight

Integrated solution for quick and easy installation. Keyhole opening, easy access to wiring, no need to remove the lens or open and all units have knock outs.

- L70 of 100,000 hours
- Ceiling wall or suspended mount
- 0-10V dimmable, 5yr warranty

Order #	Size	Watt	Lumens
65034	24"L	20	2600
65035	48"L	41	5330
65036	96"L	78	10,140



*Corrosion, Water, Dust
and Vandal Proof*

TRI-Proof LED Luminaire

Industrial sites, commercial and public lighting, Reduce energy consumption up to 59%.

- 50 000 hours, 4 000K, 80CRI
- 5 year warranty, Wet location rated
- Surface or suspended mounting options
- Resists to impacts up to IK10
- Operating temperature -20 to 40°C (-4 to 104°F)

Order #	Size	Watt	Lumens	Voltage
64922S	24"L	20	1900	120-277
64923	48"L	40	3800	120-277
64924	48"L	40	3800	347



STANDARD's LED PANEL Series

These edge-lit LED flat panels provide an optimal alternative to traditional fluorescent luminaires. Totally uniform, smooth and visually comfortable lighting with low glare. Sleek aluminum housing with frosted lens for even light distribution. Perfect for offices, educational and medical facilities or commercial buildings.



Spec's: Maintenance free, 50,000hr rated, 80+CRI, ultra thin and lightweight, easy install, edge-lit technology, integrated driver, dimmable 0-10V, Broad light distribution and glare-free

LED Panel Series

PART#	DESCRIPTION	WATTS	VOLTS	LUMENS	LUMENS PER/WATT	BEAM ANGLE	COLOUR TEMP
PANELS 1' x 4'							
64697	LED/PANEL/1X4/120-347V-DIM/40W/35K/STD	40	120-347	4177	104	120	3500
64698	LED/PANEL/1X4/120-347V-DIM/40W/40K/STD	40	120-347	3981	100	120	4000
64699	LED/PANEL/1X4/120-347V-DIM/40W/50K/STD	40	120-347	4373	109	120	5000
PANELS 2' x 2'							
65542	LED/PANEL/2X2/120-347V-DIM/40W/35K/STD	40	120-347	4872	130	120	3500
65543	LED/PANEL/2X2/120-347V-DIM/40W/40K/STD	40	120-347	4926	130	120	4000
65544	LED/PANEL/2X2/120-347V-DIM/40W/50K/STD	40	120-347	5034	130	120	5000
PANELS 2' x 4'							
65545	LED/PANEL/2X4/120-347V-DIM/50W/35K/STD	50	120-347	5559	130	120	3500
65546	LED/PANEL/2X4/120-347V-DIM/50W/40K/STD	50	120-347	5607	130	120	4000
65547	LED/PANEL/2X4/120-347V-DIM/50W/50K/STD	50	120-347	5705	130	120	5000

LED ECO High Bay

Perfect solution for high bay applications and with its low profile and durable design panels, mount from 10 to 50 feet. Reduce energy and maintenance costs, It is easy to retrofit your commercial or industrial application.

- Up to 42 000 Lumens
- L70 122 000 hour life
- Warranted lifetime 50 000 hours
- 0-10 V dimming, Included diffuser
- Surface, pendant or hanging mount
- Operating temperatures: -20 to 50°C (-4 to 122°F)



Order #	Watts	Initial Lumens	Color Temp K	Voltage
2 Foot				
65515	110	14,300	4000	120-277V
65516	162	21,060	4000	120-277V
65518	162	21,222	5000	120-277V
65561	162	21,060	4000	347V
4 Foot				
65517	223	28,990	4000	120-277V
65519	223	29,213	5000	120-277V
65559	321	42,051	5000	120-277V
65560	321	42,051	5000	347V
65562	223	28,990	4000	347V

Accessories

- 64614 Hanger Kit 110W-220W
- 64615 Hanger Kit 160W
- 64616 Pendant Mount
- 64617 Wireguard 110W
- 64618 Wireguard 160W
- 64619 Wireguard 220W
- 64620 Surface Mount 110W-220W
- 64621 Surface Mount 160W

Bell Shape LED High Bay

Designed for all rugged applications, perfect option for new or retrofit applications. One-for-one replacement of 400 W HID Luminaires. Reduce loads on cooling systems with less heat and virtually maintenance free. Designed for high ceiling application, beam angle options from 60° to 120°.

80CRI, Dimmable / 4000K colour temp / 130 lumen per watt

Order #	Watts	Voltage	Initial Lumens	Life Hours L70
65388	150	120-277	19,323	87,000
65389	150	347-480	19,323	87,000
65791	200	120-277	26,062	72,000
65796	200	347-480	26,080	72,000
Reflectors		Beam Angle		
64201		60°		
64202		90°		
64203		70°		



65388



65389



64201



64202



64203

Bullet Style



See our website for movable track heads and track components



A. Single Bullet Canopy
1/75W/PAR20/R20 or A19
766101WH White
766101PTR Pewter

B. Two Bullet Canopy
2/75W/PAR20/R20 or A19
766102WH White
766102PTR Pewter

C. Three Bullet Canopy
3/75W/PAR20/R20 or A19
766103WH White
766103PTR Pewter

D. Two Bullet Track
2/75W/PAR20/R20 or A19
766302WH White
766302PTR Pewter

E. Three Bullet Track
3/75W/PAR20/R20 or A19
766303WH White
766303PTR Pewter

F. Four Bullet Track
4/75W/PAR20/R20 or A19
766304WH White
766304PTR Pewter



bulb styles



Luna III



A. Single Head, Brushed Nickel
Frosted Glass, 1/60W/A15 or
R20
754181BN/FR

B. Double Head, Brushed Nickel
Frosted Glass, 2/60W/A15 or
R20
754182BN/FR

C. Triple Head, Brushed Nickel
Frosted Glass, 3/60W/A15 or
R20
754183BN/FR

D. Double Head, Brushed Nickel
Frosted Glass, 2/60W/A15 or
R20
754172BN/FR

E. Triple Head, Brushed Nickel
Frosted Glass, 3/60W/A15 or
R20
754173BN/FR

F. Quad Head, Brushed Nickel
Frosted Glass, 4/60W/A15 or
R20
754174BN/FR

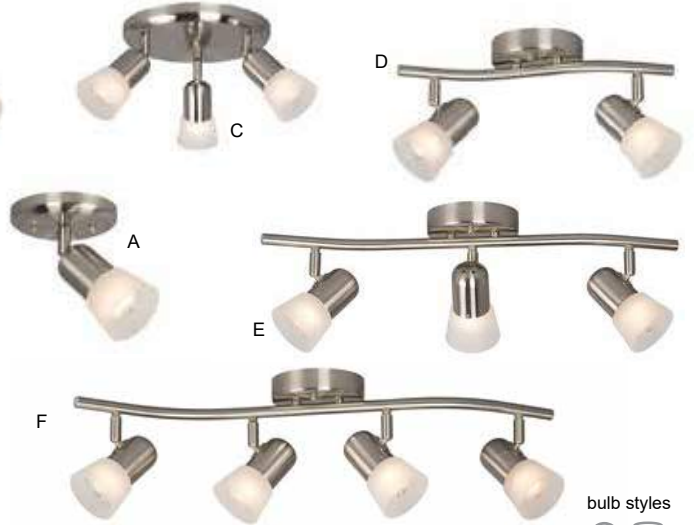

bulb styles



May not be exactly as shown

Newburn

New!

A. Single Head, Brushed Nickel
White Glass, 3.5W LED/3000K,
300 Lumens, Dimmable
L753197BN

B. Double Head, Brushed Nickel
White Glass, 2x3.5W
LED/3000K, 600 Lumens,
Dimmable
L753198BN

C. Triple Head, Brushed Nickel
White Glass, 3x3.5W
LED/3000K, 900 Lumens,
Dimmable
L753199BN

D. Double Head, Brushed Nickel
White Glass, 2x3.5W
LED/3000K, 600 Lumens,
Dimmable
L753192BN

E. Triple Head, Brushed Nickel
White Glass, 3x3.5W
LED/3000K, 900 Lumens,
Dimmable
L753193BN

F. Quad Head, Brushed Nickel
White Glass, 4x3.5W
LED/3000K, 1200 Lumens,
Dimmable
L753194BN

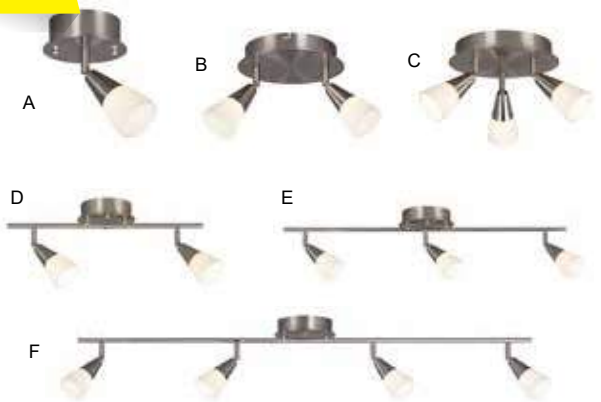

Outdoor Lights



Round Marine
7"D x 3-3/4"E
1/60W
305012WH
305012BK
305012SA

10-1/4"W X 5-1/2"E
1/100W
305011WH
305011BK
305011SA



Oval Marine
4-3/8"W X 8-3/4"H X 4-1/2"E
1/60W
305014WH
305014BK
305014SA

6-1/2"W X 11-1/8"H X 5"E
1/100W
305013WH
305013BK
305013SA



"Ublo" LED Outdoor Fixture
Black with acrylic lens
6-1/4"Dia x 4-1/8"D
8.5W LED, 200 Lumens, 2700K
LOL272BK



LED Outdoor Fixture
7W, 500 Lumens, 3000K,
30000hrs, Acrylic lens, plastic
body
4-1/4"W X 9-1/2"H X 3-1/4"D
BRWL-SQ6W-N-BK



"Fidjy" LED Outdoor Fixture
Black with acrylic lens
4-3/4"W x 10-1/4"H x 3-1/2"D
2x6W LED, 160Lumens, 2700K
LOL271BK



"Haika" LED Outdoor Fixture
Black with acrylic lens
4-3/4"W x 10-1/4"H x 4-1/2"D
12W LED, 400 Lumens, 2700K
LOL273BK

New!



"Leland" LED Outdoor Fixture
Matte Black with frosted glass
4-1/4"W x 13"H x 6-1/2"D
15W LED, 435 Lumens, 3000K
LOL306BK



LED Outdoor Fixture
7W, 500 Lumens, 3000K,
30000hrs, Acrylic lens, plastic
body
6-1/2"W X 8-1/2"H X 4-3/4"D
BRWL-GBB6W-N-BK



Outdoor Cast Lantern
6-1/4"W X 12-1/2"H X 7-1/4"E
1x100W
301090WH
301090BK



Outdoor Cast Lantern
6-1/4"W x 11-1/2"H x 7-1/2"E
1x100W
301830WH
301830BK



Outdoor Cast Lantern
6"W x 16"H x 7"E
1x100W
301020WH
301020BK



Outdoor Cast Lantern
6"W X 15-3/8"H X 6-3/4"E
1x100W
301021WH
301021BK



Dusk-til-dawn



LED Dusk 'Til Dawn Security Light. Black with clear lens. 18W LED, 1500 Lumens included. 50,000 hours.
LED-SL18BK-C



Porch Fixture
4-1/2"W X 7-1/2"H X 5-1/2"E
1/60W
C102-1-B Black Fitter
C102-1-WH White Fitter
61035GW 6" Glass Globe Only



Porch Fixture
6"W X 8-1/2"H X 6-1/4"E
1/60W
C102-1-B Black Fitter
C102-1-WH White Fitter
12301-GC Jam Jar Glass Only



2/pk



Porch Fixture
8-1/2" X 6" X 6-1/2"E
1/60W G style lamp
IOL143TBK-C Black



STANDARD



64602S Bronze
64603S White
 LED Security Light. 50,000hr, 24watt, 180deg
 65ft motion sensor, adjustable, 4000K 2058
 lumen.



L6002BR Bronze
 180° Motion Activated Floodlight with Bulb
 Shields. Adjustable settings. Dusk to dawn
 feature. 2 x 75w PAR max sold separate,
 medium bulbs sold separate

COOPER Lighting

L.E.D.
 Outdoor Security Light
Saves up to 90%!



FSS1530LPES Bronze w/photo cell
 All-Pro LED Security Light
 - 1900 Lumens, 30W
 - Perfect for wall or eave mount
 - Heavy Duty die-cast aluminum
 - 35,000hr life
 - 21W/1350 lumen with dusk to dawn photo
 control



MINI LUX CUBE

STANPRO

Best
 Sellers



FEATURES:

Residential and commercial. Tough weather resistant polycarbonate housing with die cast aluminium base. Prismatic reflector. Easy lamp replacement. Lamp included. SIZE: 6-3/4" x 11" x 5-1/4", 120 volts.

Part#	Mini Lux Wall Cube	Watts/Lamp
WPI-S0050-A	Cube	50W HPS
WPI-S0050-AP	Cube c/w photocell	50W HPS
WPI-S0070-A	Cube	70W HPS
WPI-S0070-AP	Cube c/w photocell	70W HPS

LUX CUBE

STANPRO



FEATURES:

Tough die cast aluminium housing. Moisture and dust proof. Dark bronze powder coat finish, it blends w/any surrounding. Lamp is included White finish available, special order. Alternative voltages and wattages also available. 13" x 9" x 7-1/4"

Part#	Watts/Lamp/Volts
WPS-S0070-A	70W HPS/120

Wall mounted luminaire, best suited for entrances, underpasses or anywhere security lighting is required.

LITHONIA LIGHTING

L.E.D. Outdoor
 Ceiling Light



OLCFM-15-WH White
OLCFM-15-DBB Dark Bronze
LED 15W Outdoor general purpose ceiling mount light.
 - Perfect for porches, covered walks and entrances
 - 70% output at 50,000hrs
 - 15 watt, 1077 Lumens, 4000K
 - Cast aluminum w/ acrylic diffuser
 - 120V, -30C to 40C



STANDARD



Part#	Watts	Volts	Lumen
64841	45	120-277	4100
64842	45	347	4100
64843	65	120-277	6450
64844	65	347	6450



LED Canopy and Garage Light

Equivalent replacement for 100-175w metal halide luminaires.
 -40 to 40C rated. Low profile. 50,000hr, 4000K, 160deg beam angle



We supply a full line of **Energy Efficient Commercial Lighting** including **NEW LED** models
www.amresupply.com/lighting





Wall Pack Square - Integrated Dusk to Dawn Photocell - LED



PART#	WATTS	VOLTS	COLOUR	CRI	AVG. LIFE	INITIAL LUMENS	HID EQU.
65570S	20	120-277	4000	80+	50,000	2100	70



Sleek Wall Pack Round - LED



PART#	WATTS	VOLTS	COLOUR	CRI	AVG. LIFE	INITIAL LUMENS	HID EQU.	FINISH
63772	18	120	4000	83	50,000	1750	70	BLACK
63776	30	120	4000	82	50,000	2800	70-100	BLACK
63774	18	120	4000	83	50,000	1750	70	BRONZE
63778	30	120	4000	82	50,000	2800	70-100	BRONZE

Other Colours Available! White & Silver



Wall Pack Classic - LED



PART#	WATTS	VOLTS	COLOUR	CRI	AVG. LIFE	INITIAL LUMENS	BEAM ANGLE	HID EQU.
65579	30	120-277	4000	70+	50,000	2778	n/a	70-100
65580	50	120-277	4000	70+	50,000	5110	n/a	150-175
65581	60	120-277	4000	70+	50,000	7456	n/a	200-250
65582	40	347	4000	70+	50,000	4654	n/a	100-175

*65580 and 65581 are dimmable

LED Wall Pack luminaires are ideal replacements for traditional High Pressure Sodium & Metal Halide fixtures, while offering a similar design with significant reduction in energy and maintenance costs. Bronze die cast aluminum heat sink. Exceptional performance in cold climates. Round Wall Packs have integrated dusk to dawn photocell incl. Classic Wall Packs use corrosion resistant stainless steel bolts and screws.



Wall Pack Classic - Full Cut-off - LED



PART#	WATTS	VOLTS	COLOUR	CRI	AVG. LIFE	INITIAL LUMENS	HID EQU.
65566	50	120-277	4000	80+	50,000	5826	150-175
65568	80	120-277	4000	80+	50,000	9053	200-250

65568 is dimmable



Outdoor Slim Wall Pack - LED (Bronze)

PART#	WATTS	VOLTS	COLOUR	CRI	AVG. LIFE	INITIAL LUMENS	BEAM ANGLE	HID EQU.
65572	30	120-277	4000	80+	50,000	3337	Adj.	100
65574	50	120-277	4000	80+	50,000	5349	Adj.	150-175
65576	80	120-277	4000	80+	50,000	9328	Adj.	200-250
65578	40	347	4000	80+	50,000	4204	Adj.	100-150

Slim wall pack luminaires offer a sleek design with adjustable tilt to ensure light is being directed where needed. They are perfect for a variety of applications such as entrances, walkways or building perimeter in residential or commercial applications.



Flood Light Series - LED

PART#	WATTS	VOLTS	COLOUR	CRI	AVG. LIFE	INITIAL LUMENS	BEAM ANGLE	MOUNTING TYPE	HID EQU.
65589	30	120-277	4000	70+	50,000	3400	n/a	Knuckle	50
65592	50	120-277	4000	80+	50,000	6000	n/a	Knuckle	150-175
65591	30	120-277	4000	80+	50,000	3400	n/a	Yoke	70-100
65593	50	120-277	4000	80+	50,000	6000	n/a	Yoke	150-175
65594	100	120-277	4000	80+	50,000	12,468	n/a	Slip Fitter	250
65596	150	120-277	4000	80+	50,000	18,852	n/a	Slip Fitter	250-400
65601	150	347	4000	80+	50,000	18,383	n/a	Slip Fitter	250-400
65597	220	120-277	4000	80+	50,000	28,362	n/a	Slip Fitter	400
65602	220	347	4000	80+	50,000	27,252	n/a	Slip Fitter	400
65569S	50	120-277	4000	80+	50,000	5500	n/a	n/a	100-150

LED Flood Light Series are designed for use in commercial, difficult to reach areas that typically house traditional energy consuming fixtures. Versatility in mounting options allows for installation in a variety of applications. Bronze die cast aluminum heat sink. Exceptional performance in cold climates. Corrosion resistant stainless steel bolts and screws Perfect for use for wall washing, lighting pathways, and signage lighting.



Replacement Parts



61035-W White
3-1/4" Fitter, 60W Max.



61035GW White



61038-W White
3-3/4" Fitter 60W Max.



61038GW
8" White Globe, 4" Neck



61008H-CH Chrome
61008H-WH White
5" Swedish Globe Holder,
100W Max.



61008G A = 8"
61010G A = 10"
Swedish Globe, White No Neck

Poly



JAM605W
Plastic Globe White Globe
3-1/16" Threaded Neck



12301-GC
Jam Jar, Clear, 3 1/4" Neck

GLOBES

Custom Sizes Available!

Globe Dia.	Watts	Max HID	White W/Neck	Neck Dia.	White No/Neck	Hole Dia.
6"	60	-	ACWG6N	4"	ACWG6	3.5"
8"	100	75	ACWG8N	4"	ACWG8	3.5"
10"	100	75	ACWG10N	4"	ACWG10	3.5"
12"	100	50	ACWG12N	4"	ACWG12	3.5"
14"	100	50	ACWG14N	4"	ACWG14	5.25"
16"	150	75	ACWG16N	6"	ACWG16	5.25"
18"	200	100	-	-	ACWG18	Spec
20"	300	175	ACWG20N	6"	ACWG20	Spec

Available in clear and white, acrylic remains the strongest industry seller.



31288
Bedroom 2 Lamp Fitter, White
with hardware, wall mount



31288-12
Bedroom 12" Square Glass
Shade, May/May Not Have
Etchings

PC-75
White Plastic Cap 1/8" IPS



22611-H
Bathroom 2 Lamp Fitter,
White with hardware, wall
mount

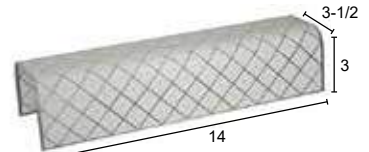

22611-G-14
14" U Shaped Bathroom
Glass, 1 Hole Mount, White

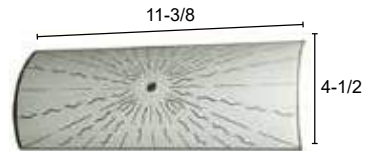

GSG-907
11.5" Curved Bathroom Glass, 1
Hole Mount, White



24611-H
Bathroom 4 Lamp Fitter,
White with hardware,
wall mount



24611-G-24
24" U Shaped Bathroom Glass,
2 Hole Mount, White



SF77-129
Plastic Black Post Top Fitters
60W, For 3" Pole (CSA Approved). Use with acrylic globes.





Measure carefully before ordering, custom cut are special order and non returnable. We highly recommend sending us a sample to ensure correct ordering.



Quick Custom & Other Styles Available

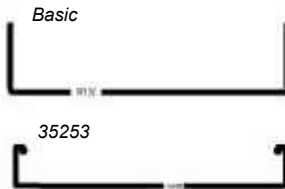

Part #	Size	Ref#
59899	7-5/8"W x 2-3/4"H x 47-3/16"L	F38 / SF252
35298	7-1/4"W x 2-1/2"H x 47-1/4"L	F41 / SF232
35277	9"W x 2-1/4"H x 47-1/4"L	F8 / SF132
F25	6-3/8"W x 2"H x 47-3/4"L	No Ref
E50	8-3/4"W x 2-3/4"H x 47-1/4"L	E50 / SF112
35274	14-1/2"W x 2-1/4"H x 47-1/4"L	F12 / SF114
35253*	11-1/16"W x 1-11/16"H x 47-15/16"L	E2 / SM192

P12 Wrap around clear acrylic lenses for fluorescent light fixtures. Many other sizes and styles available as well as custom jobs. (.110" thickness)

Quick Custom & Other Styles Available

Standard .110" Thick

P12-14-AF-STD	11-3/4" x 47-3/4"
P12-22-AF-STD	23-3/4" x 23-3/4"
P12-24-AF-STD	23-3/4" x 47-3/4"
P12-24-AF-STD F	24" x 48"

Commercial .125" Thick

P12-24-AF-125	23-3/4" x 47-3/4"
----------------------	-------------------

Flat P12 pattern acrylic clear prismatic lenses. Available is standard thickness or commercial .125". Custom sizes available.

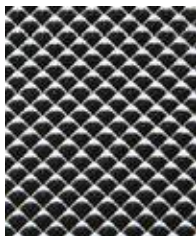

Quick Custom & Other Styles Available

White Styrene Premium Plastic

35444 (ECS-14)	11-3/4" x 47-3/4" (1/2")
ECS-24	23-3/4" x 47-3/4" (1/2")
ECS-24-3	23-3/4" x 47-3/4" (3/8")
Aluminum (Mill Finish)	
AL500-24-MF	23-3/4" x 47-3/4" (1/2")

Eggcrate louvers. Other sizes, styles as well as custom available.

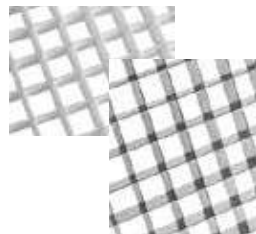

Louvers

Eggcrate style for both lighting and HVAC applications are in stock at most locations



Lenses and Louvers

From simple K12 flat sheet prismatics to paracube louvers, paracircle or hexalite lenses. We can assist you with simple replacements to more effective light distribution. Custom sizes are available from supplier. Call us or visit one of our locations for details!



Great for Closets, Basements, & Attics!



9863-OCC

Leviton Compact Fluorescent Lampholder with Occupancy Sensor 13W 2700K compact fluorescent bulb, 900 lumens, 10,000 hours. Clear polycarbonate lamp guard. Indoor use only. Lamp included.



8827-CW1 Plastic
29816-C Porcelain
Pull chain incandescent lamp holder. Medium base, one piece, top wired. 660W/250V rated.



8829-CW4 Plastic
49875 Porcelain
Keyless incandescent lamp holder. Medium Base, one piece, top wired, 660W/250V rated.



3152
Medium Keyless Lampholder



2006
Medium - Medium Plastic Lampholder



2005
Medium - Medium Porcelain Lampholder



1406-W
Medium - Medium Pull Chain Lampholder with 2 Outlets



Wrap Lenses

Amre Supply carries a variety of acrylic wrap lenses for all brands and makes of surface mount fluorescent fixtures. Send us your exact measurements or provide a sample to ensure the right replacement.



Diffusers

Simple residential fluorescent hallway lighting, outdoor canopy drop pan diffusers for service stations, HID lighting diffusers in commercial parking lots. Let us know what you need and we can find it!



Globes

Commercial, Residential, Municipal applications. We stock and carry white and clear indoor and outdoor acrylic globes for many applications. Coloured globes for specific applications available



FEATURES:

Dual LED display, Quick test push button
For typical emergency lighting needs. Heads can be fitted, top, sides or front of the unit. 120 or 347 volt battery is included.

Emergency Light Series

EMERGENCY LIGHT PACKS

PART#	VOLTS	WATTS	#OF HEADS	TYPE
SLA06036-2N09T	6	36	2	SLA*
SLA06050-2N09T	6	50	2	SLA*
SLB06072-2N09T	6	72	2	SLB
SLA12036-2N09T	12	36	2	SLA*
SLA12072-00	12	72	0	SLA*
SLA12072-2N09T	12	72	2	SLA*
SLB06100-2NT9	6	100	2	SLB
SLB12100-00	12	100	0	SLB
SLB12100-2NT9	12	100	2	SLB
SLC12160-00	12	160	0	SLC
SLC12160-2N09T	12	160	2	SLC
SLC12200-00	12	200	0	SLC
SLC12250-2N09T	12	250	2	SLC
SLC12360-00	12	360	0	SLC
SLC12360-2N09T	12	360	2	SLC

Other models and 24V available on request. *c/w cord installed

REMOTE HEADS

N SERIES	VOLTS	#OF HEADS
N1-06V09WT	6	1
N1-12V09WT	12	1
N1-24V09WT	24	1
N2-06V09WT	6	2
N2-12V09WT	12	2
N2-24V09WT	24	2



N Series Thermoplastic PAR18

Thermoplastic remote heads, Adjustable locking tilt and swivel. Designed for use with 6, 12 or 24V emergency lighting circuits. 5" canopy mounts directly to a standard electrical boxes. White, 9 watts.

N1-06-12V3WLLJ 6or12 1

N2-06-12V3WLLJ 6or12 2

LED remote heads will work on 6 or 12V systems. 3 watt/head



DECORATIVE THERMOPLASTIC EMERGENCY LIGHT SERIES



PART#

SLE-2 6 volts

Slim line decorative emergency light which will fit well in any commercial application. Impact, heat and scratch resistant, thermoplastic and universal mounting plate

- Use on 120 or 347 volt circuits
- 6V maintenance free, sealed lead acid battery is included
- Provides 30 watts for 30 minutes of emergency lighting.
- LED display - Quick test, push button - White finish

IMPORTANT

These new style running man signs cannot be combined with regular exits in a building. If 1 is changed all must be changed to qualify for code.

Plastic

RMPNOWH-IB

Running man exit sign. Plastic

- LED ultra bright light source
- 120/347VAC Input, field selectable
- Sealed Ni-Cad battery, 2.2W Single or double sided
- 90 minutes emergency duration (120 available)
- High impact, UV stabilized, thermoplastic construction
- 12.5" x 8.5", white, c/w 3 pictogram legends
- Universal mount and knockouts



Steel

RMS0WH-IB

Running man exit sign - Steel

- LED ultra bright light source
- 120/347VAC Input, field selectable
- 2.0W power consumption single or double face
- Ni-Cad battery, 90 minute emergency duration
- Steel, 7.74" x 12", white
- Comes with 3 pictogram legends



EXIT SIGNS

Commercial Thermoplastic Exit Series

PART#
SLEXP0WH
SLEXP0WH/IB with internal backup

FEATURES:

- high impact thermoplastic commercial exit signs
- long-life, high brightness LEDs
- consumption as low as just 1.8W AC
- quick-snap faceplates, backplate and universal canopy
- stamped with a universal mounting pattern
- White
- 120/347VAC dual input voltage



Best Sellers

Commercial Steel Exit Series

PART#
SLEXSC0WH
SLEXSC0WH-IB with internal backup

FEATURES:

- Commercial, slim line steel signs
- Long-life, high brightness LED
- Consumption as low as 1.2W
- Multiple conduit knockouts
- Universal mounting canopy kit complete each model
- White baked powder coat finish
- 120/347VAC dual input voltage



Commercial Steel Combination Exit Series

PART#
SPEXS60360-2N09T

FEATURES:

- Commercial, slim line steel signs (white)
- Long-life, high brightness LED
- Multiple conduit knockouts
- Universal mounting canopy kit
- Dual LED display
- Quick test, push button, backup 1/2 hr. battery included
- 6V, 36 watts, 2 head (9WPAR18) 120/347V

Also available in other wattages and voltages on request.



G-112 Exit 12" x 8"

G-113 Arrow 8" x 5"
Self-Adhesive Glow-in-the-dark flexible vinyl signs. Glows up to 8hrs. Visible in normal lighting. Will not wear out. Adheres to non-porous surfaces



SIG32A Exit 12" x 8"

SIGA37 Arrow 14" x 3.5"
High Quality Glow-in-the-dark Plastic Sign. Exit model includes (2) self-adhesive arrow stickers. Durable, Easy installation. Two-sided tape on reverse. 5 minutes of light exposure on the face will provide 26+ hours of illumination.





Emergency Lamps

T-5 EMERGENCY LAMPS, 6V - 24 VOLTS - CLEAR

PART#	TYPE	WATTS	VOLTS	BASE	AVG. LIFE/HRS.
927	T-5	7.2	6	W2.1X9.5d	50
908SL	T-5	9	6	W2.1X9.5d	50
915	T-5	9	12	W2.1X9.5d	50
EMS-2409W	T-5	9	24	W2.1X9.5d	75

Wedge Base



Best Sellers

LED Exit Lamp / U Shape Red (2/pk)



PART#	WATTS	BASE	VOLTS	COLOUR	AVG. LIFE (HOURS)	LUMENS	LEN. (INCHES)
27115-2	1.2	E12/E17/DC	120	Red	100000	-	5-1/8"

T6 EXIT - E12 CANDLE BASE



PART#	WATTS	BASE	VOLTS	COLOUR	AVG. LIFE (HOURS)	FILAMENT	LUMENS	LEN. (INCHES)
15T6/CL/E12	15	E12	145	Clear	7500	C-7A	90	3.0"

T6 - E12



T6 EXIT - E17 INTERMEDIATE BASE



PART#	WATTS	BASE	VOLTS	COLOUR	AVG. LIFE (HOURS)	FILAMENT	LUMENS	LEN. (INCHES)
15T6/CL/E17	15	E17	145	Clear	7500	C-7A	90	3.0"

T6 - E17



T6.5 EXIT - E12 CANDLE BASE



PART#	WATTS	BASE	VOLTS	COLOUR	AVG. LIFE (HOURS)	FILAMENT	LUMENS	LEN. (INCHES)
25T6.5/CL/E12	25	E12	145	Clear	7500	C-8	180	5.5"

T6.5 - E12

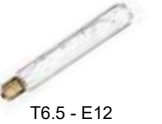

T6.5 EXIT - E17 INTERMEDIATE BASE



PART#	WATTS	BASE	VOLTS	COLOUR	AVG. LIFE (HOURS)	FILAMENT	LUMENS	LEN. (INCHES)
25T6.5/CL/E17	25	E17	145	Clear	7500	C-8	180	5.5"
40T6.5/CL/E17	40	E17	130	Clear	5000	C-8	280	5.4"

T6.5 - E17



A15



PART#	WATTS	BASE	VOLTS	COLOUR	AVG. LIFE (HOURS)	FILAMENT	LUMENS	LEN. (INCHES)
15A15CL	15	E26	130	Clear	5000	C-9	85	3.5"
15A15F	15	E26	130	Frost	5000	C-9	80	3.5"
25A15CL	25	E26	130	Clear	5000	C-9	135	3.5"
25A15F	25	E26	130	Frost	5000	C-9	135	3.5"
40A15CL	40	E26	130	Clear	2500	C-9	290	3.5"
40A15F	40	E26	130	Frost	2500	C-9	280	3.5"
60A15CL	60	E26	130	Clear	2500	C-9	580	3.5"
60A15F	60	E26	130	Frost	2500	C-9	570	3.5"

A15

CHECK ONLINE BEFORE ORDERING
Are these bulbs available in your province?



LED A15 - 120V - DIMMABLE - APPLIANCE/FAN LAMPS - M.O.L. 3-7/16"



PART#	WATTS	BASE	COLOUR	CRI	AVG. HRS.	INITIAL LUMENS	INCAND. EQU. (W)
S9030	5.5	E26	2700/Frost	80	25,000	450	40
S9031	5.5	E26	3000/Frost	80	25,000	450	40
S9032	5.5	E26	4000/Frost	80	25,000	450	40
S9033	5.5	E26	5000/Frost	80	25,000	450	40

Approved for totally enclosed fixtures, damp location, 3yr warranty

PRO PICK

A15

Check the AMRE website for our selection of old style RP-11 and S-8 Emergency lamps!
www.amresupply.com/lighting



CHECK ONLINE BEFORE ORDERING
Are these bulbs available in your province?



A19

4 PACK!



PRO PICK

Omni A19



Omni A19



Omni A19



A19



Omni A19

A19 VIBRATION SERVICE - 2500 HRS



PART#	DESCRIPTION	WATTS	BASE	VOLTS	COLOUR	LUMENS	LEN. (INCHES)
S3941	40A19CL	40	E26	130	Clear	300	4.125
S3951	40A19F	40	E26	130	Frost	300	4.125
S3942	60A19CL	60	E26	130	Clear	580	4.125
S3952	60A19F	60	E26	130	Frost	580	4.125
100A19RS	100A19F	100	E26	130	Frost	1050	4.25

Rough service lamps are designed for heavy duty use such as building site applications where a more robust lamp is required.

These vibration service lamps are approved to replace A19 for government legislation!

LED OMNI A19 - 120V AVG. LIFE 15,000 - NON-DIMMABLE



PART#	DESCRIPTION	WATTS	BASE	COLOUR	CRI	INITIAL LUMENS	INCAND. EQUIV.(W)
64931	Omni A19	9.5	E26	2700	80	750	60
64932	Omni A19	9.5	E26	3000	80	750	60
64970	Omni A19	9.5	E26	4000	80	750	60
64971	Omni A19	9.5	E26	5000	80	750	60

LED Omni A19 - AVG. LIFE: 15,000 - NON DIMMABLE



PART#	DESCRIPTION	WATTS	BASE	COLOUR	CRI	INITIAL LUMENS	INCAND. EQUIV.(W)
66267	Omni A19	6	E26	2700	80	500	40
66268	Omni A19	6	E26	3000	80	550	40
66269	Omni A19	9.5	E26	2700	80	900	60
66270	Omni A19	9.5	E26	3000	80	850	60
S8765	Omni A19	11	E26	2700	80	1100	75
S8766	Omni A19	11	E26	3000	80	1100	75
S8767	Omni A19	11	E26	4000	80	1100	75
S8768	Omni A19	11	E26	5000	80	1100	75
S28787	Omni A19	15.5	E26	4000	80	1600	100

LED Omni A19 are the perfect replacement for traditional lamps. Medium E26 Base. Damp location appr. and 80CRI

LED OMNI A19 - 120V AVG. LIFE: 25,000 - DIMMABLE



PART#	DESCRIPTION	WATTS	BASE	COLOUR	CRI	INITIAL LUMENS	INCAND. EQU. (W)
64809	Omni A19	5.5	E26	2700	81	455	40
64810	Omni A19	5.5	E26	3000	83	521	40
64811	Omni A19	5.5	E26	4000	83	563	40
64812	Omni A19	5.5	E26	5000	86	545	40
64805	Omni A19	9.5	E26	2700	81	832	60
64807	Omni A19	9.5	E26	4000	83	881	60
64808	Omni A19	9.5	E26	5000	85	861	60
S9810	Omni A19	11.5	E26	2700	80	1100	75
S9811	Omni A19	11.5	E26	3000	80	1100	75
S29812	Omni A19	11.5	E26	4000	80	1100	75
S9813	Omni A19	11.5	E26	5000	80	1100	75
S29815	Omni A19	15	E26	2700	80	1600	100
S29816	Omni A19	15	E26	3000	80	1600	100
S29817	Omni A19	15	E26	4000	80	1600	100
S29818	Omni A19	15	E26	5000	80	1600	100

LED A19 - 120V AVG. LIFE 15,000 - SPECIALTY COLOURS - M.O.L 4-3/16"



PART#	DESCRIPTION	WATTS	BASE	COLOUR	INITIAL LUMENS
S9642	A19	2	E26	Red	200
S9643	A19	2	E26	Green	200
S9644	A19	2	E26	Blue	200
S9645	A19	2	E26	Yellow	200

Approved for totally enclosed fixtures, damp locations, 3yr warranty

Check local government incentive programs for energy saving rebates!

LED OMNI A19 - 120V AVG. LIFE 25,000 - TRI-LIGHT - M.O.L 4-5/8"



PART#	DESCRIPTION	WATTS	BASE	COLOUR	CRI	INITIAL LUMENS	INCAND. EQUIV.(W)
S9317	Omni A19	3/9/12	E26	3000	80	280/950/1200	30/70/100
S9318	Omni A19	3/9/12	E26	4000	80	280/950/1200	30/70/100
S9319	Omni A19	3/9/12	E26	5000	80	280/950/1200	30/70/100

Approved for totally enclosed fixtures, damp locations, 3yr warranty





OMNI A21

4 PACK!

Best Sellers

Med. Base E26



Med. Base E26



Med. Base E26



GU24



GU24 Base



GU24 Base

LED OMNI A21 - 120V - NON-DIMMABLE - M.O.L 5-9/16"



PART#	WATTS	BASE	COLOUR	CRI	AVG. HRS.	INITIAL LUMENS	INCAND EQU. (W)
S8786	16	E26	3000	80	15000	1600	100
S8788	16	E26	5000	80	15000	1600	100

Approved for totally enclosed fixtures, damp location, 3yr warranty

SPIRAL CFL



PART#	SHAPE	BASE	WATTS	INCAN EQU.	VOLTS	COLOUR	AVG. LIFE (HOURS)	INITIAL LUMENS	M.O.L. (INCHES)
CF13/27K/4PK	SPIRAL	E26	13	60	120	2700	10000	900	4.4"
CF13/30K/4PK	SPIRAL	E26	13	60	120	3000	10000	900	4.4"
CF13/41K/4PK	SPIRAL	E26	13	60	120	4100	10000	880	4.4"
CF13/50K/4PK	SPIRAL	E26	13	60	120	5000	10000	880	4.4"

MEDIUM BASE



PART#	SHAPE	BASE	WATTS	INCAN EQU.	VOLTS	COLOUR	AVG. LIFE (HOURS)	INITIAL LUMENS	M.O.L. (INCHES)
S7227	SPIRAL	E26	23	100W	120	2700K	12000	1600	4.88"
S7228	SPIRAL	E26	23	100W	120	4100K	12000	1600	4.88"
S7229	SPIRAL	E26	23	100W	120	5000K	12000	1600	4.88"
S7231	SPIRAL	E26	26	100W	120	2700K	10000	1750	5.07"
S7232	SPIRAL	E26	26	100W	120	4100K	10000	1750	5.07"
S7233	SPIRAL	E26	26	100W	120	5000K	10000	1750	5.07"

HI-PRO - MEDIUM BASE - HIGHER LUMEN PERFORMANCE FOR GREATER LIGHT OUTPUT

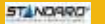

PART#	SHAPE	BASE	WATTS	INCAN EQU.	VOLTS	COLOUR	AVG. LIFE (HOURS)	INITIAL LUMENS	M.O.L. (INCHES)
S7331	SPIRAL	E26	32	100W	120	2700K	10000	2000	6.73"
S7332	SPIRAL	E26	32	100W	120	4100K	10000	2000	6.73"
S7333	SPIRAL	E26	32	100W	120	5000K	10000	2000	6.73"
S7334	SPIRAL	E26	40	150W	120	2700K	10000	2600	7.28"
S7335	SPIRAL	E26	40	150W	120	4100K	10000	2600	7.28"
S7336	SPIRAL	E26	40	150W	120	5000K	10000	2600	7.28"
S7337	SPIRAL	E26	55	300W	120	2700K	10000	3700	9.64"
S7338	SPIRAL	E26	55	300W	120	4100K	10000	3700	9.64"
S7339	SPIRAL	E26	55	300W	120	5000K	10000	3700	9.64"

LED OMNI GU24 - 120V - DIMMABLE



PART#	DESCRIPTION	WATTS	BASE	COLOUR	CRI	AVG. HRS.	INITIAL LUMENS	INCAND. EQUIV.(W)
S9840	Omni A19	9.5	GU24	2700	80	25000	800	60
S9841	Omni A19	9.5	GU24	3500	80	25000	845	60
S9814	Omni A19	11.5	GU24	2700	80	25000	1100	75
S9819	Omni A21	15.5	GU24	2700	80	25000	1600	100

Approved for totally enclosed fixtures, damp locations, 3yr warranty

GU24



PART#	SHAPE	BASE	WATTS	INCAN EQU.	VOLTS	COLOUR	AVG. LIFE (HOURS)	INITIAL LUMENS	M.O.L. (INCHES)
CF13/27K/GU24	SPIRAL	GU24	13	60	120	2700	10000	900	3.6"
CF13/35K/GU24	SPIRAL	GU24	13	60	120	3500	10000	880	3.6"
CF13/41K/GU24	SPIRAL	GU24	13	60	120	4100	10000	880	3.6"
CF18/27K/GU24	SPIRAL	GU24	18	75	120	2700	10000	1150	4.05"
S8209	SPIRAL	GU24	18	75	120	4100	10000	1200	4.05"
CF23/27K/GU24	SPIRAL	GU24	23	100	120	2700	10000	1600	4.4"
S8232	SPIRAL	GU24	23	100	120	3500	10000	1600	4.96"
S8210	SPIRAL	GU24	23	100	120	4100	10000	1600	4.41"
S8207	SPIRAL	GU24	26	120	120	2700	10000	1750	5.16"
S8233	SPIRAL	GU24	26	120	120	3500	10000	1750	5.16"

Contact your local Amre Sales Rep to inquire on the latest wattages and colours available, as they are released!

GU24 SQUAT SHAPE

PART#	SHAPE	BASE	WATTS	INCAN EQU.	VOLTS	COLOUR	AVG. LIFE (HOURS)	INITIAL LUMENS	M.O.L. (INCHES)
S8227	SPIRAL	GU24	13	60	120	2700	10000	850	2.28"
S8228	SPIRAL	GU24	18	75	120	2700	10000	1100	2.60"





B10 - E12 CANDLE BASE, 130V, 3000 HR., 3.9"L

PART#	WATTS	COL.	FILAMENT	LUMENS	STANDARD
CTC15/32	15	Clear	C-7A	75	
CTC25/32	25	Clear	CC-2V	165	
CTF25/32	25	Frost	CC-2V	165	
CTC40/32	40	Clear	CC-2V	280	
CTF40/32	40	Frost	CC-2V	280	
CTC60/32	60	Clear	C-7A/3	430	
CTF60/32	60	Frost	C-7A/3	430	

B10 - E26 - MEDIUM BASE, 130V, 3000 HR., 3.5"L

PART#	WATTS	COL.	FILAMENT	LUMENS	STANDARD
ETC15/32	15	Clear	C-7A	75	
ETC25/32	25	Clear	CC-2V	165	
ETF25/32	25	Frost	CC-2V	165	
ETC40/32	40	Clear	CC-2V	280	
ETF40/32	40	Frost	CC-2V	280	



Candle - LED DECORATIVE LAMPS - 120V - DIMMABLE



PART#	WATTS	BASE	COL.	CRI.	AVG. HRS.	FINISH	INITIAL LUMENS	INCAND EQU. (W)
S8950	2.8	E12	3000	80	25000	CLEAR	165	25
S8951	4.5	E12	2700	80	25000	CLEAR	300	40
S8952	4.5	E12	3000	80	25000	CLEAR	300	40
S8953	4.5	E26	3000	80	25000	CLEAR	300	40

Approved for totally enclosed fixtures, damp locations, 3yr warranty



G16.5 - E12 CANDLE BASE, 130V, 3000 HR., 3"L

PART#	WATTS	COL.	FILAMENT	LUMENS	STANDARD
15G16.5CC	15	Clear	C-7A	70	
15G16.5CW	15	White	C-7A	60	
25G16.5/CND/CL	25	Clear	CC-2V	135	
25G16.5/CND/WH	25	White	CC-2V	120	
40G16.5/CND/CL	40	Clear	CC-2V	250	
40G16.5/CND/WH	40	White	CC-2V	230	
60G16.5/CND/CL	60	Clear	CC-2V	440	
60G16.5/CND/WH	60	White	CC-2V	400	

G16.5 - E26 MEDIUM BASE, 130V, 3000 HR., 3"L

PART#	WATTS	COL.	FILAMENT	LUMENS	STANDARD
25G16.5/MED/CL	25	Clear	CC-2V	135	
25G16.5/MED/WH	25	White	CC-2V	120	
40G16.5/MED/CL	40	Clear	CC-2V	250	
40G16.5/MED/WH	40	White	CC-2V	230	

Globe G16.5 - CANDLE BASE LAMPS LED - 120V - DIMMABLE

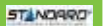

PART#	WATTS	BASE	COL.	AVG. HRS.	FINISH	INITIAL LUMENS	INCAND EQU. (W)
63736	3	E12	2700	25000	CLEAR	200	25
63737	5	E12	2700	25000	CLEAR	374	40
63738	5	E12	2700	25000	FROST	375	40

Globe G16.5 (E12)

G25 - E26 MEDIUM BASE (3-1/8"Dia)



PART#	WATTS	BASE	VOLTS	COLOUR	AVG. LIFE (HOURS)	FILAMENT	LUMENS	LEN. (INCHES)
25G25CL	25	E26	130	Clear	3000	C-9	135	4.5"
25G25WH	25	E26	130	White	3000	CC-6	160	4.5"
40G25CL	40	E26	130	Clear	3000	C-9	255	4.5"
40G25W	40	E26	130	White	3000	C-9	230	4.5"

G25



Globe G25 (E26)

Globe - LED G TYPE E26 BASE LAMPS - 120V - DIMMABLE



PART#	WATTS	BASE	COL.	AVG. HRS.	FINISH	INITIAL LUMENS	INCAND EQU. (W)
S9200	6	E26	2700	25000	FROST	450	40-60
S9201	6	E26	3000	25000	FROST	470	40-60
S9202	6	E26	4000	25000	FROST	490	40-60
S9203	6	E26	5000	25000	FROST	510	40-60





G25 - E26 MEDIUM BASE (3-1/8"Dia) - HALOGEN



G25

PART#	WATTS	BASE	VOLTS	COLOUR	AVG. LIFE (HOURS)	LUMENS	LEN. (INCHES)
S2437	43	E26	120	Clear	1000	750	4.5"
S2438	43	E26	120	White	1000	750	4.5"

Replacement option for 60G25, 60W lamps

G30 - E26 MEDIUM BASE (3-3/4"Dia)



G30

PART#	WATTS	BASE	VOLTS	COLOUR	AVG. LIFE (HOURS)	FILAMENT	LUMENS	LEN. (INCHES)
25G30CL	25	E26	130	Clear	3000	C-9	115	5.4"
25G30WH	25	E26	130	White	3000	C-9	100	5.4"
40G30CL	40	E26	130	Clear	3000	C-9	230	5.4"
40G30W	40	E26	130	White	3000	C-9	215	5.4"

G40 - E26 MEDIUM BASE (5"Dia)



G40

PART#	WATTS	BASE	VOLTS	COLOUR	AVG. LIFE (HOURS)	FILAMENT	LUMENS	LEN. (INCHES)
40G40CL	40	E26	130	Clear	3000	C-9	230	6.9"
40G40W	40	E26	130	White	3000	C-9	215	6.9"
60G40CL	60	E26	130	Clear	3000	C-9	465	6.9"
60G40W	60	E26	130	White	3000	C-9	365	6.9"



What Are Lumens?
Lumens measure the total amount of visible light emitted. It's the physical count of how much light you get from a lamp. This is why lumens are more important than wattage.

FOOTCANDLE

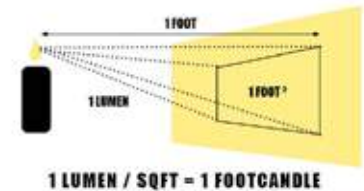

Lamp Exchangers

New!



3 Piece
46710AG 10'

4 Piece
46716AG 16'
Extension Pole. Constructed of lightweight fluted aluminum to reduce user fatigue.



PAR Lamps



S70-3001
Light Bulb Changer removes and installs PAR type lamps. Simply attach the suction cup to the center of the bulb, unscrew the bulb and remove it from the socket. 3-1/4" width. Extension poles sold separate.



R Lamps



S70-3002
Light Bulb Changer removes and installs R type lamps. Simply attach the suction cup to the center of the bulb, unscrew the bulb and remove it from the socket. 2-1/2" width. Extension poles sold separate.



A & PS Lamps



S70-0101
Bulb Changer assists in removing and installing A or PS shaped incandescent lamps. Simply push the "fingers" of the changer over the center of the bulb until it is grasped properly. Unscrew the bulb and remove it from the socket. Extension poles sold separate.

Save energy and money! Check your local government incentive programs for energy saving rebates!





R16



R20



R20



BR30



BR30



BR40



BR40
INFRARED

R16 - E26 MEDIUM BASE (1-7/8"Dia)



PART#	WATTS	BASE	VOLTS	COLOUR	BEAM	AVG. LIFE (HOURS)	FILAMENT	LUMENS	LEN. (INCHES)
40R16/FL/RP	40	E26	120	Soft Wh.	FLOOD	1000	CC-6	472	3.5"
60R16/E/SW	60	E26	130	Soft Wh.	FLOOD	1000	CC-6	730	3.5"

R20 - E26 MEDIUM BASE (2-1/2"Dia)



PART#	WATTS	BASE	VOLTS	COLOUR	BEAM	AVG. LIFE (HOURS)	FILAMENT	LUMENS	LEN. (INCHES)
30R20/FL	30	E26	130	Frost	FLOOD	5000	C-9	135	3.9"
45R20/FL	45	E26	130	Frost	FLOOD	5000	CC-6	225	3.9"

LED R20 FLOOD - MED. - DIMMABLE



PART#	DESCRIPTION	WATTS	BASE	COLOUR	CRI	AVG. HRS.	INITIAL LUMENS	INCAND EQU. (W)
S9630	R20 Flood	6.5	E26	2700	80	25000	525	50
S9631	R20 Flood	6.5	E26	3000	80	25000	525	50
S9632	R20 Flood	6.5	E26	4000	80	25000	525	50

BR30 (3-3/4"Dia)



PART#	WATTS	BASE	VOLTS	COLOUR	BEAM	AVG. LIFE (HOURS)	FILAMENT	LUMENS	LEN. (INCHES)
65BR30/FL55	65	E26	130	Clear	FLOOD	5000	CC-6	470	5.1"

LED BR30 - 120V - DIMMABLE



PART#	DESCRIPTION	WATTS	BASE	COLOUR	CRI	AVG. HRS.	INITIAL LUMENS	INCAND EQU. (W)
S9620	BR30 Flood	9.5	E26	2700	80	25000	750	65
S9621	BR30 Flood	9.5	E26	3000	80	25000	750	65
S9622	BR30 Flood	9.5	E26	4000	80	25000	750	65
S9623	BR30 Flood	9.5	E26	5000	80	25000	750	65

BR40 (4-3/4"Dia)



PART#	WATTS	BASE	VOLTS	COLOUR	BEAM	AVG. LIFE (HOURS)	FILAMENT	LUMENS	LEN. (INCHES)
65BR40FL/ES	65	E26	130	Clear	FLOOD	5000	CC-6	470	6.6"

LED BR40 - 120V - DIMMABLE



PART#	DESCRIPTION	WATTS	BASE	COLOUR	CRI	AVG. LIFE (HOURS)	INITIAL LUMENS	INCAND. EQUIV.(W)
S9639	BR40	16.5	E26	3000	80	25000	1200	85
S9640	BR40	16.5	E26	4000	80	25000	1200	85
S9641	BR40	16.5	E26	5000	80	25000	1200	85

BR40/R40 - INFRARED HEAT LAMPS



PART#	WATTS	BASE	VOLTS	COLOUR	AVG. LIFE (HOURS)	FILAMENT	LUMENS	LEN. (INCHES)
R40/BR40								
125BR40/10	125	E26	120	Clear	5000	C-9	1200	6.6"
250BR40HCL	250	E26	120	Clear	5000	C-9	2400	6.6"
250R40/10	250	E26	120	Red	5000	C-9	N/A	6.6"
375R40/IR/CL	375	E26skt	120	Clear	5000	C11-3	N/A	7.6"



PLUG-IN FLUORESCENT LAMPS FOR MAGNETIC BALLAST FIXTURES

Plug-in lamps provide even light distribution and stay brighter longer with a life of 12 000 hours. They are ideal for interior lighting.

Features

- 2 pin designation
- Starting temperature: -26 °C / -14 °F

Benefits

- Save on maintenance cost

Applications

- Recessed cans
- Wall + Ceiling Fixtures

**Longer Life
12,000 hrs.**

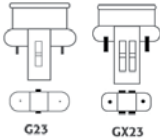

MAGNETIC BALLAST - 2 PIN - TWIN TUBE

STANDARD

PART#	SHAPE	BASE	WATTS	INCAN EQU.	VOLTS	COLOUR	AVG. LIFE (HOURS)	INITIAL LUMENS	M.O.L. (INCHES)
CF5DS/827	TWIN TUBE	G23	5	25W	120	2700	12000	250	4.1
CF5DS/841	TWIN TUBE	G23	5	25W	120	4100	12000	250	4.1
CF7DS/827	TWIN TUBE	G23	7	30W	120	2700	12000	400	5.3
CF7DS/835	TWIN TUBE	G23	7	30W	120	3500	12000	400	5.3
CF7DS/841	TWIN TUBE	G23	7	30W	120	4100	12000	400	5.3
CF9DS/827	TWIN TUBE	G23	9	40W	120	2700	12000	600	6.5
CF9DS/835	TWIN TUBE	G23	9	40W	120	3500	12000	600	6.5
CF9DS/841	TWIN TUBE	G23	9	40W	120	4100	12000	600	6.5
CF9DS/850	TWIN TUBE	G23	9	40W	120	5000	12000	600	6.5
CF13DS/827	TWIN TUBE	GX23	13	60W	120	2700	12000	900	7.1
CF13DS/830	TWIN TUBE	GX23	13	60W	120	3000	12000	900	7.1
CF13DS/835	TWIN TUBE	GX23	13	60W	120	3500	12000	900	7.1
CF13DS/841	TWIN TUBE	GX23	13	60W	120	4100	12000	900	7.1
CF13DS/850	TWIN TUBE	GX23	13	60W	120	5000	12000	900	7.1

LED MAGNETIC BALLAST - 2 PIN - VERT OR HORZ OPERATION - 50,000HR - NON DIMMABLE 7-3/32" MOL

STANDARD

PART#	WATTS	BASE	COLOUR	CRI	INITIAL LUMENS	FLUOR. EQUIV.(W)
65366	6	GX23	2700	83	525	13
65367	6	GX23	4000	83	550	13

7-3/32" MOL
Vert./Horizontal

LED MAGNETIC BALLAST - 2 PIN - HORIZONTAL OPERATION - 50,000HR - NON DIMMABLE 5-1/2" MOL

STANDARD

PART#	WATTS	BASE	COLOUR	CRI	INITIAL LUMENS	FLUOR. EQUIV.(W)
65371	6	GX23	2700	83	500	13
65372	6	GX23	4000	83	525	13

5-1/2" MOL
Horizontal

**Longer Life
12,000 hrs.**

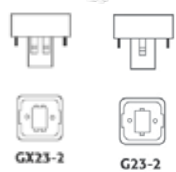

MAGNETIC BALLAST 2-PIN - DOUBLE TUBE

STANDARD

PART#	SHAPE	BASE	WATTS	INCAN EQU.	VOLTS	COLOUR	AVG. LIFE (HOURS)	INITIAL LUMENS	M.O.L. (INCHES)
CF9DD/827	DBL TUBE	G23-2	9	40W	120	2700	12000	600	4.3
CF9DD/841	DBL TUBE	G23-2	9	40W	120	4100	12000	600	4.3
CF13DD/827	DBL TUBE	GX23-2	13	60W	120	2700	12000	900	4.7
CF13DD/830	DBL TUBE	GX23-2	13	60W	120	3000	12000	900	4.7
CF13DD/835	DBL TUBE	GX23-2	13	60W	120	3500	12000	900	4.7
CF13DD/841	DBL TUBE	GX23-2	13	60W	120	4100	12000	900	4.7
CF18DD/827	DBL TUBE	G24D-2	18	75W	120	2700	12000	1200	6.0
CF18DD/835	DBL TUBE	G24D-2	18	75W	120	3500	12000	1200	6.0
CF18DD/841	DBL TUBE	G24D-2	18	75W	120	4100	12000	1200	6.0
CF26DD/827	DBL TUBE	G24D-3	26	100W	120	2700	12000	1800	6.8
CF26DD/835	DBL TUBE	G24D-3	26	100W	120	3500	12000	1800	6.8
CF26DD/841	DBL TUBE	G24D-3	26	100W	120	4100	12000	1800	6.8



Magnetic ballast lamps have 2 pins and electronic have 4 pins.
Check before ordering!





LED MAGNETIC BALLAST - 2 PIN - HORIZONTAL OPERATION



PART#	WATTS	BASE	COLOUR	CRI	AVG. LIFE (HOURS)	INITIAL LUMENS	FLUOR. EQUIV.(W)
S9854	9	G24D	3000	82	50000	850	26
S9855	9	G24D	3500	82	50000	850	26
S9856	9	G24D	4000	82	50000	900	26
S9857	9	G24D	5000	82	50000	900	26



LED MAGNETIC BALLAST - 2 PIN - VERTICAL OPERATION



PART#	WATTS	BASE	COLOUR	CRI	AVG. LIFE (HOURS)	INITIAL LUMENS	FLUOR. EQUIV.(W)
S9862	9	G24D	3000	82	50000	850	26
S9863	9	G24D	3500	82	50000	850	26
S9864	9	G24D	4000	82	50000	900	26
S9865	9	G24D	5000	82	50000	900	26

PLUG-IN FLUORESCENT LAMPS FOR ELECTRONIC BALLAST FIXTURES

Plug-in lamps provide even light distribution and stay brighter longer with a life of up to 12 000 hours. They are ideal for interior lighting.

Features

- 4 pin designation
- Starting temperature: -26 °C / -14 °F

Benefits

- Save on maintenance cost

Applications

- Recessed cans
- Wall + Ceiling Fixtures



2GX7

ELECTRONIC BALLAST - 4-PIN - TWIN TUBE



PART#	SHAPE	BASE	WATTS	INCAN EQU.	VOLTS	COLOUR	AVG. LIFE (HOURS)	INITIAL LUMENS	M.O.L. (INCHES)
CF13DS/E/827	T4	2GX7	13	60W	120	2700	12000	900	6.2"
CF13DS/E/830	T4	2GX7	13	60W	120	3000	12000	900	6.2"
CF13DS/E/841	T4	2GX7	13	60W	120	4100	12000	900	6.2"

ELECTRONIC BALLAST 4-PIN - TWIN TUBE LONG



PART#	SHAPE	BASE	WATTS	INCAN EQU.	VOLTS	COLOUR	AVG. LIFE (HOURS)	INITIAL LUMENS	M.O.L. (INCHES)
FT18DL/830	T5	2G11	18	75W	120	3000	12000	1250	9"
FT18DL/835	T5	2G11	18	75W	120	3500	12000	1250	9"
FT18DL/841	T5	2G11	18	75W	120	4100	12000	1250	9"
PL24/35K/L/4P	T5	2G11	24	90W	120	3500	12000	1800	12.9"
FT24DL/841	T5	2G11	24	90W	120	4100	12000	1800	12.9"
FT36DL/830	T5	2G11	36	150W	120	3000	12000	2900	16.6"
FT36DL/835	T5	2G11	36	150W	120	3500	12000	2900	16.6"
FT36DL/841	T5	2G11	36	150W	120	4100	12000	2900	16.6"
FT40DL/830/RS*T5	T5	2G11	40	175W	120	3000	12000	3150	22.6"
FT40DL/835/RS*T5	T5	2G11	40	175W	120	3500	12000	3150	22.6"
FT40DL/841/RS*T5	T5	2G11	40	175W	120	4100	12000	3150	22.6"
FT55DL/830	T5	2G11	55	300W	120	3000	20000	4800	21.1"
FT55DL/835	T5	2G11	55	300W	120	3500	12000	4800	21.1"
FT55DL/841	T5	2G11	55	300W	120	4100	12000	4800	21.1"

*RS models for rapid start



2G11

LED High Lumen CFL FT40DL (PL-L) Replacement Lamps. Damp Location - Instant On



PART#	SHAPE	BASE	WATTS	COLOUR	CRI	AVG. LIFE (HOURS)	INITIAL LUMENS	M.O.L. (INCHES)
S9730	T5	2G11	23	3500	82	50000	2600	22.5"
S9951	T5	2G11	23	4000	82	50000	2800	22.5"

No re-wiring, electronic ballast dependent

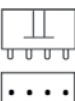

2G11





ELECTRONIC BALLAST 4-PIN - DOUBLE TWIN TUBE

STANDARD

ALL MODELS ARE 82 CRI RATED



PART#	SHAPE	BASE	WATTS	INCAN EQU.	VOLTS	COLOUR	AVG. LIFE (HOURS)	INITIAL LUMENS	M.O.L. (INCHES)
CF13DD/E/827	T4	G24Q-1	13	60W	120	2700	12000	900	5.2"
CF13DD/E/830	T4	G24Q-1	13	60W	120	3000	12000	900	5.2"
CF13DD/E/835	T4	G24Q-1	13	60W	120	3500	12000	900	5.2"
CF13DD/E/841	T4	G24Q-1	13	60W	120	4100	12000	900	5.2"
CF18DD/E/827	T4	G24Q-2	18	75W	120	2700	12000	1200	5.8"
CF18DD/E/830	T4	G24Q-2	18	75W	120	3000	12000	1200	5.8"
CF18DD/E/835	T4	G24Q-2	18	75W	120	3500	12000	1200	5.8"
CF18DD/E/841	T4	G24Q-2	18	75W	120	4100	12000	1200	5.8"
CF26DD/E/827	T4	G24Q-3	26	100W	120	2700	12000	1800	6.5"
CF26DD/E/830	T4	G24Q-3	26	100W	120	3000	12000	1800	6.5"
CF26DD/E/835	T4	G24Q-3	26	100W	120	3500	12000	1800	6.5"
CF26DD/E/841	T4	G24Q-3	26	100W	120	4100	12000	1800	6.5"

LED ELECTRONIC BALLAST - 4 PIN - HORIZONTAL OPERATION

SATCO



PART#	WATTS	BASE	COLOUR	CRI	AVG. LIFE (HOURS)	INITIAL LUMENS	FLUOR. EQUIV.(W)
S9850	9	G24Q	3000	82	50000	850	26
S9851	9	G24Q	3500	82	50000	850	26
S29852	9	G24Q	4000	82	50000	900	26
S9853	9	G24Q	5000	82	50000	900	26

LED ELECTRONIC BALLAST - 4 PIN - VERTICAL OPERATION

SATCO



PART#	WATTS	BASE	COLOUR	CRI	AVG. LIFE (HOURS)	INITIAL LUMENS	FLUOR. EQUIV.(W)
S29858	9	G24Q	3000	82	50000	850	26
S9859	9	G24Q	3500	82	50000	850	26
S9860	9	G24Q	4000	82	50000	900	26
S9861	9	G24Q	5000	82	50000	900	26

ELECTRONIC BALLAST 4-PIN - TRIPLE TWIN TUBE

STANDARD



PART#	SHAPE	BASE	WATTS	INCAN EQU.	VOLTS	COLOUR	AVG. LIFE (HOURS)	INITIAL LUMENS	M.O.L. (INCHES)
CF26DT/E/IN/835	T4	GX24Q-3	26	100W	120	3500	12000	1800	5.2"
CF26DT/E/IN/841	T4	GX24Q-3	26	100W	120	4100	12000	1800	5.2"
CF32DT/E/IN/835	T4	GX24Q-3	32	140W	120	3500	12000	2400	5.8"
CF32DT/E/IN/841	T4	GX24Q-3	32	140W	120	4100	12000	2400	5.8"
CF42DT/E/IN/830	T4	GX24Q-4	42	170W	120	3000	12000	3200	6.5"
CF42DT/E/IN/835	T4	GX24Q-4	42	170W	120	3500	12000	3200	6.5"
CF42DT/E/IN/841	T4	GX24Q-4	42	170W	120	4100	12000	3200	6.5"

Did you know?

NEW LED versions last 4x as long as traditional CFLs Make the switch today!

Contact AMRE for an on-site audit!



T5 - ELECTRONIC LINEAR FLUORESCENT BALLASTS - Program Start

PART#	LAMP	LAMP TYPE	VOLTS
E221T5PS120-277/N	1 or 2	F21T5, F14T5	120-277
E224T5PS120-277/N	1 or 2	F24T5	120-277
E22835T5120-277	1 or 2	F28T5, F35T5	120-277
E22835T5-347	1 or 2	F28T5, F35T5	347

T5 Extreme Temperature Ballast.

XTRM = work in extreme temperatures. -30°C to +90°C. Good for warehouse, parking lots, hot or cold environments.

E454T5PS120-277	1 to 4	F54T5, PLL55W, F39T5, PLL50W	120-277
E454T5PS347/XTRM	1 to 4	F54T5, PLL55W, F39T5, PLL50W	347



T8 - ELECTRONIC LINEAR FLUORESCENT BALLASTS - Instant Start

PART#	LAMP	LAMP TYPE	VOLTS
E132PI120L	1	F17T8, F25T8, F32T8	120
E232PI120G01	1 or 2	F17T8, F32T8, F25T8, F40T8(1only), LED18T8, LED22T8	120
E232PI347G01	1 or 2	F17T8, F32T8, F25T8, F32T8ES, F40T8(1only)	347
E332T8IS120	2 or 3	F32T8, F25T8, F17T8, F32T8ES, F40T8(2only)	120
E332PI347G01	2 or 3	F17T8, F32T8, F25T8, F32T8ES, F40T8(2only)	347
E432PI120G11	1 to 4	F17T8, F32T8, F25T8, F32T8ES, F40T8(3only), LED18T8, LED22T8	120
E432PI347G01	1 to 4	F17T8, F32T8, F25T8, F32T8ES, F40T8(3only), LED18T8, LED22T8	347

Best Sellers

T8 - 8 FT LAMP BALLASTS (* Extreme temperature ballast)

PART#	LAMP	LAMP TYPE	VOLTS	BALLAST TYPE
E296T8IS120/N	1 or 2	F40T8, F72T8, F96T8/ES, F96T8	120	Instant Start
E296FOPI347G01	1 or 2	F40T8, F72T8, F96T8/ES, F96T8	347	Instant Start
E296T8PRS120/N/HO*	1 or 2	F48T8HO, F60T8HO, F72T8HO, F96T8HO	120-277	Program Start
E296T8PRS347/N/HO*	1 or 2	F48T8HO, F60T8HO, F75T8HO, F96T8HO	347	Program Start

T12 - ELECTRONIC (Replaces old NLA magnetic ballasts)

PART#	LAMP	LAMP TYPE	VOLTS	BALLAST TYPE
E240SR120G01	1 or 2	F40T12, F34T12, F30T12, F40T12 (25W shop light)	120	Rapid Start
E240SR347G01	1 or 2	F40T12, F34T12, F30T12	347	Pro Rapid
E296PI120G11	1 or 2	F96T12, F96T12/ES, F72T12, F84T12, F60T12, F48T12 x2 F48T12/ES x2	120	Instant Start
E296T12IS347/N	1 or 2	F96T12, F72T12, F96T12/ES, F84T12, F64T12, F60T12, F48T12	347	Instant Start
E296T12PRS120/HO	1 or 2	F96T12HO, F96T12HO/ES, F72T12HO x2, F60T12HO x2, F48T12HO x2	120	Rapid Start
E296T12PRS347/N/HO	1 or 2	F96T12HO, F96T12HO/ES, F72T12HO x2, F60T12HO x2, F48T12HO x2	347	Pro Rapid

Convert from fluorescent to LED tubes!



FLUORESCENT

LED

TIRED OF GUESSING WHICH MODEL OF CFL BALLAST YOU NEED? High Power Factor . Flicker Free . Auto Restart
All lighting applications and inventory requirements from 120 to 347 volts are covered with FLEXCONNECT's 6 models.

COMPACT FLUORESCENT ELECTRONIC BALLAST (Flex Connect)

PART#	LAMP	LAMP TYPE	VOLTS	BALLAST TYPE
E22642-120-277	1 or 2	26 to 42W, 50 to 55W(1 only), CFL-DTT/4P, TTT/4P, PL-L/4P	120-277	Program Start
E22642-277-347	1 or 2	26 to 42W, 50 to 55W(1 only), CFL-DTT/4P, TTT/4P, PL-L/4P	277-347	Program Start
E21338-120-277	1 or 2	13 to 18W, 26W(1 only), CFL-DTT/4P, TTT/4P, PL-L/4P 16 to 38W type 2D, 14 to 28W, T5 and T8	120-277	Rapid Start
E21338-277-347	1 or 2	13 to 18W, 26W(1 only), CFL-DTT/4P, TTT/4P, PL-L/4P 16 to 38W type 2D, 14 to 28W, T5 and T8	277-347	Rapid Start
E22142-120-277	1	26 to 42W, CFL-DTT/4P, TTT/4P, PL-L/4P, FC9T5, FC12T5	120-277	Rapid Start
E22142-277-347	1	26 to 42W, CFL-DTT/4P, TTT/4P, PL-L/4P, FC9T5, FC12T5	277-347	Rapid Start

Give us a call or go online www.amresupply.com for sizes and detailed information!

COMPACT FLUORESCENT ELECTRONIC BALLAST (Match Box)

PART#	LAMP	LAMP TYPE	VOLTS	BALLAST TYPE
E528-120-SL	1	5 to 28W type 2D, PL, PLT, T5, T8, T12	120	Instant
E528-347-SL	1	5 to 28W type 2D, PL, PLT, T5, T8, T12	347	Instant

Give us a call or go online www.amresupply.com for sizes and detailed information!

T9 CIRCLINE PREHEAT CORE & COIL, ENCASED MAGNETIC BALLASTS

PART#	LAMP	LAMP TYPE	DIMENSIONS	VOLTS	BALLAST TYPE
SSN2PWS	1	FC6T9, FC8T9	2.75"L X 1.89"W X 1.42"H	120	PH encased w/socket

COMPACT FLUORESCENT MAGNETIC BALLASTS

PART#	LAMP	LAMP TYPE	WATTS	VOLTS	BALLAST TYPE
FP90103	1	PL7-TT/2P, PL9-TT/2P, PL9-DTT/2P (NPF)	7 or 9	120	CFL
SP2RC	1	PL13-TT/2P, PL13-DTT/2P (NPF)	13	120	CFL

HIGH INTENSITY DISCHARGE BALLAST (HID)

METAL HALIDE BALLAST

PART NUMBER	VOLTAGE	WATTS/ANSI	TYPE
BALM0050TCL	120/277/347V 60 Hz	50 Watt (M110)	Core & Coil HX-HPF
BALM0070TCL	120/277/347V 60 Hz	70 Watt (M85/M98)	Core & Coil HX-HPF
BALM0100TCL	120/277/347V 60 Hz	100 Watt (M90)	MH/MV Core & Coil
BALM0150TCL	120/277/347V 60 Hz	150 Watt (M81/M102)	MH/MV Core & Coil
BALM0175TCA	120/277/347V 60 Hz	175 Watt (M57 or H39)	MH/MV Core & Coil
BALM0250TCA	120/277/347V 60 Hz	250 Watt (M58 or H37)	MH/MV Core & Coil
BALM0400TCA	120/277/347V 60 Hz	400 Watt (M59 or H33)	MH/MV Core & Coil

Pulse Start and Post Line ballasts available, special order, call for price and availability

HIGH PRESSURE SODIUM

PART NUMBER	VOLTAGE	WATTS/ANSI	TYPE
BALS0035ACR	120V 60 Hz	35 Watt (S76)	Core & Coil
BALS0050ACR	120V 60 Hz	50 Watt (S68)	Core & Coil
BALS0070ACR	120V 60 Hz	70 Watt (S62)	Core & Coil
BALS0100ACR	120V 60 Hz	100 Watt (S54)	Core & Coil
BALS0150ACR	120V 60 Hz	150 Watt-55V ARC (S-55)	Core & Coil

HALOGEN TRANSFORMERS - SIGN

The light weight, compact electronic transformers for 12V Halogen lamps offer high efficiency, low installation and running costs. Short circuit protection, overload protection, automatic restart and dimmable

PART#	WATTS	LAMP LENGTH	INPUT VOLTS	OUTPUT VOLTS	TEMP RANGE
31015STD	60	65L X 35W X 23H	120V	12V	10°C to 40°C
31016STD	80	90L X 35W X 23H	120V	12V	10°C to 40°C
31017STD	150	109L X 36W X 29H	120V	12V	10°C to 40°C



AMRE carries ballasts For All H.I.D. Lamps Give us a call!





EARTH SAVER T5

Benefits

- Operates on programmed start electronic ballast only, unless otherwise identified
- High system efficiency
- Low mercury content and TCLP compliant
- Energy savings and reduced maintenance cost
- High colour consistency
- Limited 2 year warranty
- One System extended lamp / ballast warranty

System comparison

A typical 400 watt metal halide system uses an average of 460 watts of energy. Replacing this system with a 6 lamp, T5HO 54 watt lamp / ballast combo, reduces the energy consumption to 360 watts, representing an instant savings of 100 watts

T5 FLUORESCENT - 0.63 dia.

PART#	WATTS	BASE	COLOUR	CRI	AVG. LIFE (HOURS)	INITIAL LUMENS	MEAN LUMENS	NOM. LEN (INCHES)
F4T5/CW	4	Min Bipin	4100	85	8000	140	130	6
F6T5/CW	6	Min Bipin	4100	85	8000	280	265	9
F6T5/DL	6	Min Bipin	6500	82	8000	240	230	9
F8T5/CW	8	Min Bipin	4100	85	8000	420	400	12
F13T5/CW	13	Min Bipin	4100	62	7500	740	695	21
FP14/830/ECO	14	Min Bipin	3000	85	30000	1350	1280	22
F14T5/35K/8	14	Min Bipin	3500	85	30000	1350	1280	22
F14T5/41K/8	14	Min Bipin	4100	85	30000	1350	1280	22
F21T5/41K	21	Min Bipin	4100	85	30000	2100	2000	34
F21T5/50K	21	Min Bipin	5000	85	24000	2100	2000	34
F28T5/30K/8/PS	28	Min Bipin	3000	85	30000	2900	2755	46
F28T5/35K/8/PS	28	Min Bipin	3500	85	30000	2900	2755	46
F28T5/41K/8/PS	28	Min Bipin	4100	85	30000	2900	2755	46
F28T5/50K/8/PS	28	Min Bipin	5000	85	30000	2750	2610	46

T5 - HIGH OUTPUT (Sold each, 25/pk)

PART#	WATTS	BASE	COLOUR	CRI	AVG. LIFE (HOURS)	INITIAL LUMENS	MEAN LUMENS	NOM. LEN (INCHES)	NOM. DIA (INCHES)	EFFICACY
F24T5/30K/8/HO	24	Min Bipin	3000	85	30000	2000	1900	22	0.63	83
F24T5/35K/8/HO	24	Min Bipin	3500	85	30000	2000	1900	22	0.63	83
F24T5/41K/8/HO	24	Min Bipin	4100	85	30000	2000	1900	22	0.63	83
F24T5/50K/8/HO	24	Min Bipin	5000	85	30000	1900	1805	22	0.63	83
F39T5/30K/HO	39	Min Bipin	3000	85	30000	3500	3325	34	0.63	90
F39T5/35K/HO	39	Min Bipin	3500	85	24000	3500	3325	34	0.63	90
F39T5/41K/HO	39	Min Bipin	4100	85	30000	3500	3325	34	0.63	90
F39T5/50K/HO	39	Min Bipin	5000	85	24000	3500	3325	34	0.63	90
F54T5/30K/HO	54	Min Bipin	3000	85	30000	5000	4750	46	0.63	93
F54T5/35K/HO	54	Min Bipin	3500	85	30000	5000	4750	46	0.63	93
F54T5/41K/HO	54	Min Bipin	4100	85	30000	5000	4750	46	0.63	93
F54T5/850/HO	54	Min Bipin	5000	85	30000	5000	4750	46	0.63	93

T5 - LED - 4' Lamps - 50,000hrs (Sold each, 25/pk)

PART#	WATT	BASE	TEMP	CRI	INITIAL LUMENS	NOM. LEN (INCHES)
S9912	25	MINI BI-PIN	3500K	82	3300	48
S9910	25	MINI BI-PIN	4000K	82	3500	48
S9911	25	MINI BI-PIN	5000K	82	3500	48



Direct replacement for F54T5 lamps in existing fixtures, no re-wiring required. All glass tube, 5yr warranty, damp location. Ballast bypass version also available

COLOUR SPECTRUM

Colour Temperature

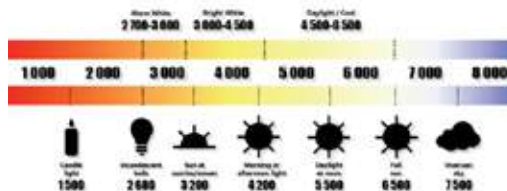



T5 CIRCLINE

T5- 5/8" DIAMETER PENTRON CIRCLINE LAMPS



DEDICATED PROGRAMMED RAPID START BALLASTS

PART#	WATTS	BULB	CRI	COLOUR TEMP	AVG. LIFE (HOURS)	LUMENS	LEN. (INCHES)
FC9T5/30K/8/PS	22	T5	82	3000	10000	1900	8.66-9.06"
FC12T5/830	40	T5	82	3000	10000	3350	11.54-12.01"
FC12T5/840	40	T5	82	4000	12000	2815	11.54-12.01"



T9 CIRCLINE



Circline 4 Pin

T9 - CIRCLINE - 10,000 AVG LIFE HRS. 1.18" DIA. (operates on electromagnetic rapid start ballasts)



PART#	WATT	BASE	COLOUR	CRI	INITIAL LUMENS	MEAN LUMENS	NOM. LEN (INCHES)	EFF.
FC6T9/CW/RS	20	4-Pin G10q	4100	82	890	710	6.5	45
FC8T9/CW/RS	22	4-Pin G10q	4100	82	1350	1110	8.25	61
FC8T9/WW/RS	22	4-Pin G10q	3000	82	1300	995	8.25	55
FC8T9/DL/RS	22	4-Pin G10q	6500	82	1210	1150	8.25	55
FC12T9/CW/RS	32	4-Pin G10q	4100	82	2300	1880	12	72
FC12T9/DL/RS	32	4-Pin G10q	6500	82	2000	1640	12	82
FC16T9/CW/RS	40	4-Pin G10q	4100	82	2750	2393	16	79



T8 - 17 WATTS - AVG LIFE HRS 24000 - 1" NOM.DIA. - 24" NOM. LEN.



PART#	BASE	COLOUR TEMP	CRI	INITIAL LUMENS	MEAN LUMENS	EFFICIENCY
F17T8/30K/8	Med Bipin	3000	85	1400	1330	82
F17T8/35K/8	Med Bipin	3500	85	1400	1330	82
F17T8/41K/8	Med Bipin	4100	85	1400	1330	82

(Sold each, 25/pk)

T8 - PREHEAT LAMPS (STARTER REQUIRED) AVG LIFE HRS 7500 - 1" NOM.DIA.



PART#	BASE	COLOUR TEMP	COLOUR	CRI	INITIAL LUMENS	NOM. LEN (INCHES)
F14T8/CW	Med Bipin	4100	COOL WHITE	62	685	15"
F14T8/D	Med Bipin	6500	DAYLIGHT	62	575	15"
F15T8/CW	Med Bipin	4100	COOL WHITE	62	610	18"
F15T8/D	Med Bipin	6500	DAYLIGHT	76	800	18"
F17T8/CW/28	Med Bipin	4100	COOL WHITE	62	1350	28"
F18T8/CW/K24	Med Bipin	4100	COOL WHITE	62	1225	24"
F18T8/CW/K26	Med Bipin	4200	COOL WHITE	62	1079	26"
F18T8/CW/K30	Med Bipin	4100	COOL WHITE	62	1400	30"

EARTH SAVER T8

Benefits

- Direct replacement for conventional 32 watt lamps except where otherwise identified
- Compatible with all T8 electronic ballasts
- Excellent colour rendering
- High system efficiency
- Low mercury content and TCLP compliant
- Energy savings and reduced maintenance cost
- Reduction in lamp-end blackening
- Limited 2 year warranty
- One System extended lamp/ballast warranty

T8 - 25 WATTS - AVG LIFE HRS 36000 HR.



PART#	BASE	COLOUR TEMP	CRI	INITIAL LUMENS	MEAN LUMENS	NOM. LEN (INCHES)	EFFICIENCY
F25T8/30K/8	Med Bipin	3000	85	2150	2040	36	89
F25T8/35K/8	Med Bipin	3500	85	2150	2040	36	89
F25T8/41K/8	Med Bipin	4100	85	2150	2040	36	89

(Sold each, 25/pk)



T8



T8 - 800 SERIES - 32 WATTS - AVG LIFE HRS 42,000 HR.



PART#	BASE	COLOUR TEMP	CRI	INITIAL LUMENS	MEAN LUMENS	NOM. LEN (INCHES)	EFFICIENCY
F32T8/830	Med Bipin	3000	85	3050	2900	48	92
F32T8/835	Med Bipin	3500	85	3050	2900	48	92
F32T8/841	Med Bipin	4100	85	3050	2900	48	92
F32T8/850	Med Bipin	5000	85	3050	2900	48	92
F32T8/865	Med Bipin	6500	85	2950	2800	48	92

(Sold each, 25/pk)



LED Retrofit T8 Linear Lamp - 50,000 hrs. - 1" Nom. Dia. Dimmable (Sold each, 25/case)

PART#	WATT	BASE	COLOUR	CRI	INITIAL LUMENS	NOM. LEN (INCHES)
65473	9	Med Bipin	4000	80	1350	24
64663	13	Med Bipin	4000	93	1600	36
65474	13	Med Bipin	3500	80	1800	48
65475	13	Med Bipin	4000	80	1900	48
65476	13	Med Bipin	5000	80	2000	48
65477	15	Med Bipin	3500	80	2000	48
65478	15	Med Bipin	4000	80	2100	48
65479	15	Med Bipin	5000	80	2200	48

(Also Available: Safety Max - shatterproof eliminates flying glass, metal, and mercury/phosphors)

T8 - LED -50,000 hrs. - 1" Nom. Dia. 120-277Volts (Sold each, 10/pk)

LED FLUORESCENT REPLACEMENT LAMPS

PART#	WATT	BASE	TEMP	CRI	INITIAL LUMENS	NOM. LEN (INCHES)
S9934	11.5	MED BI-PIN	3000K	82	1700	48
S9935	11.5	MED BI-PIN	3500K	82	1700	48
S9936	11.5	MED BI-PIN	4000K	82	1800	48
S9937	11.5	MED BI-PIN	5000K	82	2100	48
S9975	15	MED BI-PIN	3000K	82	2100	48
S9976	15	MED BI-PIN	3500K	82	2100	48
S9977	15	MED BI-PIN	4000K	82	2200	48
S9978	15	MED BI-PIN	5000K	82	2200	48

T8 - LED - 2', 3' Lamps - 50,000 hrs (Sold each, 10/pk)

LED FLUORESCENT REPLACEMENT LAMPS

PART#	WATT	BASE	TEMP	CRI	INITIAL LUMENS	NOM. LEN (INCHES)
2' LED T8						
S9946	8	MED BI-PIN	3000K	82	1200	24
S9947	8	MED BI-PIN	3500K	82	1200	24
S9948	8	MED BI-PIN	4000K	82	1250	24
S9949	8	MED BI-PIN	5000K	82	1250	24
3' LED T8						
S9990	10.5	MED BI-PIN	3000K	82	1400	36
S9991	10.5	MED BI-PIN	3500K	82	1400	36
S9992	10.5	MED BI-PIN	4000K	82	1450	36
S9993	10.5	MED BI-PIN	5000K	82	1450	36



LED T8 Lamp direct replacement for T8 with instant or rapid start ballast, no re-wiring required, Instant on to full brightness, 120-277v, 5yr warranty. Also available in 3000, 3500 and 5000K temp.



For GX23 and GX23-2 Lamp Bases - Rating: 75 Watt 600V

Part#	Mounting	Fig.	Lamp Base
7218	Horizontal Snap-In	A	GX23 / GX23-2
6573	Horizontal Screw-Down - 2 hole	A	G23 / GX23
7206	Vertical Screw-Down - 4 hole	B	GX23 / GX23-2
7207	Vertical Snap-In	B	GX23

Most Common versions listed, we have access to over 80 different compact fluorescent lampholders.

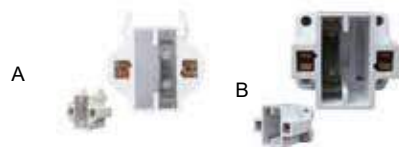

- FS2** 10-20 Watts
 - FS4** 30-40 Watts
 - FS5** 4-8 Watts
 - FS25** 18-25 Watts
- Fluorescent Starters



SK1126SW
T8/T12 Fluorescent Lampholder, slide on, Standard Profile, Captive Nut, 660W/600V

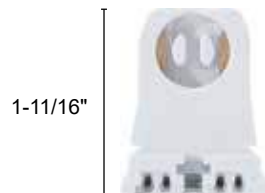

SK1226SW
T8/T12 Fluorescent Lampholder, Low Profile, Captive Nut, 660W/600V

Shunt for T8 Retrofits



38241
T8 Fluorescent Lampholder, Slide-on, Low Profile with Internal Shunt for T8 Retrofits, 660W/600V



SK1126RW (Old Style)
T8/T12 Fluorescent Lampholder, with hardware, 660W/600V



EARTH SAVER T8 - U BENT

Benefits

- Excellent colour rendering
- Low mercury content and TCLP compliant
- Energy savings, reduced maintenance cost
- Limited 2 year warranty*
- One System extended lamp / ballast warranty*



T8 - U BENT - 31 watts* 1-5/8" spacing - 1" dia. 24,000 avg. life hrs. (operates on preheat ballasts)



PART#	BASE	COLOUR	CRI	INITIAL LUMENS	MEAN LUMENS	NOM. LEN (INCHES)	EFF.
FB31T8/35K/8/U1	Med Bipin	3500	82	2750	2600	22.5	89
FB31T8/41K/8/U1	Med Bipin	4100	82	2750	2600	22.5	89



(Sold each, 20/pk)

T8 - U BENT - 6" spacing - 1" dia. 20,000 avg. life hrs. (operates on electronic ballasts)



PART#	WATTS	BASE	COLOUR	CRI	INITIAL LUMENS	MEAN LUMENS	NOM. LEN (INCHES)	EFF.
FB28T8/35K/U6	28	Med Bipin	3500	85	2550	2330	22.5	88
FB28T8/41K/U6	28	Med Bipin	4100	85	2550	2330	22.5	88
FB32T8/30K/U6	32	Med Bipin	3000	85	2800	2220	22.5	80
FB32T8/35K/U6	32	Med Bipin	3500	85	2800	2220	22.5	80
FB32T8/41K/U6	32	Med Bipin	4100	85	2800	2220	22.5	80
FB32T8/50K/U6	32	Med Bipin	5000	86	2800	2220	22.5	80



U BENT

(Sold each, 20/pk)

T8 - LED - 6" U-bend Lamps - 50,000 hrs (Sold each, 12/pk)



LED FLUORESCENT REPLACEMENT LAMPS

PART#	WATT	BASE	TEMP	CRI	INITIAL LUMENS	NOM. LEN (INCHES)
-------	------	------	------	-----	----------------	-------------------

U-BEND 6" LED T8

S9994	11.5	MED BI-PIN	3000K	82	1700	22.5
S9995	11.5	MED BI-PIN	3500K	82	1700	22.5
S9996	11.5	MED BI-PIN	4000K	82	1800	22.5
S9997	11.5	MED BI-PIN	5000K	82	1800	22.5



Direct replacement for linear or U-bend T8 fluorescent lamps in existing fixtures with instant or rapid start ballasts. No rewiring required** Over 40% energy savings vs. standard T8 systems. All glass tube - eliminating the possibility of yellowing. Direct replacement solution allows the fixture to maintain the Original UL and CSA Compliance. Long life- 50,000 hours. Instant on to full brightness / no flicker. 2 ft. DLC - listed. U-bend - NSF certified, shatterproof coated. 5 yr. warranty

T12 FLUORESCENT LAMPS

- Traditional 1-1/2" diameter
- Available in preheat or rapid start depending on application
- Specialty models available on request

T12 - PREHEAT LAMPS (STARTER REQUIRED)



PART#	WATTS	BASE	COLOUR	COLOUR TEMP	CRI	AVG. LIFE	INITIAL LUMENS	NOM. LEN (INCHES)	NOM. DIA. (INCHES)
F15T12/CW	15	Med. Bipin	COOL WH.	4200	62	7500	750	18"	1-1/2"
F20T12CW	20	Med. Bipin	COOL WH.	4200	62	9000	1200	24"	1-1/2"
F20T12/WW	20	Med. Bipin	WARM WH.	3000	52	9000	1250	24"	1-1/2"
F20T12/D	20	Med. Bipin	DAYLIGHT	6500	76	9000	1075	24"	1-1/2"

(Check website for package sizes.)

T12 - SUPER SAVER & STANDARD LAMPS - RAPID START (Sold each, 30/pk)

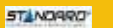

PART#	WATTS	BASE	COLOUR	COLOUR TEMP	CRI	AVG. LIFE	INITIAL LUMENS	NOM. LEN (INCHES)	NOM. DIA. (INCHES)
STANDARD LAMPS									
F30T12CW/RS	30	Med. Bipin	COOL WH.	4100	62	18000	2250	36"	1-1/2"
F30T12/D/RS	30	Med. Bipin	DAYLIGHT	6500	76	18000	1950	36"	1-1/2"
F34T12/CW/ES	40	Med. Bipin	COOL WH.	4100	90	24000	2500	48"	1-1/2"
F40/DX	40	Med. Bipin	DAYLIGHT	6500	90	24000	2250	48"	1-1/2"
F34CW/SS1160	40	Med. Bipin	COOL WH.	4100	62	20000	3070	1160mm	38.1mm

Important!

Some lamps, due to provincial legislation, may not be available for sale in all provinces. Contact your **Amre Representative** for more information.

Best Sellers



T12 SINGLE PIN



CHECK ONLINE BEFORE ORDERING
Are these bulbs available in your province?

T12 - SLIM LINE INSTANT START (SUPER SAVER LAMPS) - SINGLE PIN BASE (Sold each, 15/pk)



PART#	WATTS	TYPE	COLOUR	COLOUR TEMP	COLOUR CRI	AVG. LIFE	INITIAL LUMENS	NOM. LEN (INCHES)	NOM. DIA. (INCHES)	PKG
F96T12/CW/SS	75	Single Pin	COOL WH.	4100	89	12000	5000	96"	1-1/2"	15
F96T12/DX	75	Single Pin	DAYLIGHT	6500	84	12000	4500	96"	1-1/2"	15



T12 RECESSED



T12 RECESSED



T12 - HIGH OUTPUT (800mA) RAPID START LAMPS - RECESSED DC BASE



PART#	WATTS	TYPE	COLOUR	COLOUR TEMP	COLOUR CRI	AVG. LIFE	INITIAL LUMENS	NOM. LEN (INCHES)	NOM. DIA. (INCHES)
F48T12/CW/HO	60	Rec. DC	COOL WH.	4100	62	12000	4050	48"	1-1/2"
F48T12/D/HO	60	Rec. DC	DAYLIGHT	6500	76	12000	3400	48"	1-1/2"
F60T12/CW/HO	75	Rec. DC	COOL WH.	4100	62	12000	5150	60"	1-1/2"
F64T12/CW/HO	80	Rec. DC	COOL WH.	4100	62	12000	5600	64"	1-1/2"
F72T12/CW/HO	85	Rec. DC	COOL WH.	4100	62	12000	6350	72"	1-1/2"
F96T12CWHOSS	110	Rec. DC	COOL WH.	4100	62	12000	8800	96"	1-1/2"
F96T12/D/HO	110	Rec. DC	DAYLIGHT	6500	79	12000	7800	96"	1-1/2"



U BENT



T12 - U BENT - 6" spacing (Sold each, 12/pk)



PART#	WATTS	BASE	COLOUR	COLOUR TEMP	COLOUR CRI	AVG. LIFE	INITIAL LUMENS	NOM. LEN (INCHES)	NOM. DIA. (INCHES)
FB34T12/CW/U6	40	Med. Bipin	COOL WH.	4100	90	24000	2500	22.5	1-1/2"



Great NEW design!

- Quality Glass casing
- Metal traditional ends
- 360° Beam angle



Fluorescent

LED

40% Brighter and uses 40% LESS energy than T8's!



MINI HALOGEN LAMPS

Available in a variety of base sizes and shapes for designated applications

Features

- 6V to 130V
- Bright crisp white light
- Some models equipped with UV stop quartz

4 or 6.35mm

GY6.35 - JCD Bipin - 120 VOLTS, 6.35mm, pin to pin, clear



PART# WATTS BASE AVG. LIFE INITIAL LUMENS NOM. LEN (INCHES)

JCD120V20W/G2	20	GY6.35	2000	180	2.17
JCD120V35W/G2	35	GY6.35	2000	380	2.09
JCD120V50W/G2	50	GY6.35	2000	600	2.09
JCD120V75W/G2	75	GY6.35	2000	1050	1.93
JCD120V100W/G2	100	GY6.35	2000	1500	2.76

JC Bipin - T3 - 12 VOLTS, 4 or 6.35mm, pin to pin, clear



PART# WATTS BASE AVG. LIFE INITIAL LUMENS NOM. LEN (INCHES)

10T3Q/BL	10	G4	2000	130	1.30
20T3Q/BL	20	G4	5000	300	1.30
50T4Q/BL	50	GY6.35	4000	900	1.73

Also available: JC - EYE - PREMIUM - higher quality . long life . precise beam . constant crisp white light



G8 - JCD Bipin - WIDE PIN BASE - 120V 8mm, pin to pin, clear



PART# WATTS BASE AVG. LIFE INITIAL LUMENS NOM. LEN (INCHES)

JCD120V20W/G8	20	G8	2000	200	1.81
JCD120V35W/G8	35	G8	2000	380	1.81
JCD120V50W/G8	50	G8	2000	600	1.81
JCD120V75W/G8	75	GY8	2000	1300	1.88
JCD120V100W/G8	100	GY8	2000	1900	1.88



G4

LED JC G4 - 12V



PART# WATTS BASE COLOUR MOL AVG. HRS. INITIAL LUMENS HALOGEN EQU. (W)

S9542	1.6	G4	3000	1-7/16"	25000	200	18
S9543	1.6	G4	5000	1-7/16"	25000	200	18



G6.35

LED JC G6.35 - 12V - DIMMABLE



PART# WATTS BASE COLOUR CRI AVG. LIFE (HOURS) INITIAL LUMENS

S9544	3	G6.35	3000	80	25000	300
S9545	3	G6.35	5000	80	25000	300

G9 - JD - 120 - 130 VOLTS



PART# WATTS BASE VOLTS COLOUR AVG. LIFE INITIAL LUMENS NOM. LEN (INCHES)

GLASS BASE

H25JD/42MM/CL/G9	25	G9	130	Clear	2000	255	1.65
H35JD/42MM/F/G9	35	G9	130	Frost	2000	380	1.65
H40JD/42MM/CL/G9	40	G9	130	Clear	2000	480	1.65
H40JD/42MM/F/G9	40	G9	130	Frost	2000	480	1.65
H50JD/42MM/CL/G9	50	G9	130	Clear	2000	600	1.65
H50JD/42MM/F/G9	50	G9	130	Frost	2000	600	1.65
H60JD/42MM/CL/G9	60	G9	130	Clear	2000	800	1.65
H60JD/42MM/F/G9	60	G9	130	Frost	2000	800	1.65
H75JD/42MM/CL/G9	75	G9	130	Clear	2000	1050	1.65

CERAMIC BASE

H25JD/56MM/CL/G9	25	G9	120	Clear	2000	255	2.20
H40JD/56MM/CL/G9	40	G9	120	Clear	2000	480	2.20
H40JD/56MM/F/G9	40	G9	120	Frost	2000	480	2.20
H50JD/56MM/CL/G9	50	G9	120	Clear	2000	600	2.20
H50JD/56MM/F/G9	50	G9	120	Frost	2000	600	2.20
H60JD/56MM/CL/G9	60	G9	120	Clear	2000	800	2.20
H60JD/56MM/F/G9	60	G9	120	Frost	2000	800	2.20
H75JD/56MM/CL/G9	75	G9	120	Clear	2000	1050	2.20



G9

LED JD G9 - 120V, DIMMABLE



PART# DESCRIPTION WATTS BASE COLOUR MOL AVG. HRS. INITIAL LUMENS HALOGEN EQU. (W)

63444	LED/G9/3.5W/27K/STD	3.5	G9	2700	1-7/8"	30000	225	18
63445	LED/G9/3.5W/30K/STD	3.5	G9	3000	1-7/8"	30000	225	18
63446	LED/G9/3.5W/40K/STD	3.5	G9	4000	1-7/8"	30000	245	18





JD E11 - 130 VOLTS (Mini can base line voltage) clear, 2,000 Hrs.

STANDARD

PART#	WATTS	BASE	INITIAL LUMENS	NOM. LEN (INCHES)
H50T3/CL/E11/130	50	E11	1120	2.48
H75T3/CL/E11/130	75	E11	1350	2.48
HJD100W/MC	100	E11	1800	2.99
H150T3/CL/E11/130	150	E11	3000	2.83
H250T3/CL/E11/130	250	E11	3000	3.19

JD - EYE - PREMIUM - higher quality . long life . precise beam . crisp white light 

Also Available



T3 - REG. VOLTAGE

STANDARD

PART#	WATTS	BASE	VOLTS	COLOUR	AVG. LIFE	INITIAL LUMENS	NOM. LEN (INCHES)	NOM. LEN (MM)
HJ75W/S/130V	75	R7S	130	Clear	2000	792	3.11	79
H100T3/79MM	100	R7S	130	Clear	2000	1300	3.11	79
H100T3/119MM	100	R7S	130	Clear	2000	1300	4.69	119
H150T3/79MM	150	R7S	130	Clear	2000	2400	3.11	79
H150T3/119MM	150	R7S	130	Clear	2000	1800	4.69	119
H200T3/79MM	200	R7S	130	Clear	2000	3400	3.11	79
H200T3/119MM	200	R7S	130	Clear	2000	3400	4.69	119
H300T3/119MM	300	R7S	130	Clear	2000	5950	4.69	119
H500T3/119MM	500	R7S	130	Clear	2000	10500	4.69	119

EYE - PREMIUM - higher quality . long life . precise beam . constant crisp white light also available.



LED R7S - 120V, T3 Replacements (Non-Dimmable)

STANDARD

PART#	DESCRIPTION	WATTS	BASE	COLOUR	MOL	AVG. HRS.	INITIAL LUMENS	HALOGEN EQU. (W)
64466	R75, 78mm	5	R7S	3,000	78 mm	15,000	450	50
64467	R75, 118mm	8	R7S	3,000	118 mm	15,000	650	100



ES16/MR16 - GU10

- Lamps can be dimmed without the need for special dimmers
- Aluminized reflector keeps fixtures cool
- No fixture design constraints
- "Twist-lock" base
- Do not require transformers
- Many models with UV stop quartz

ICE

The frosted lens on the ICE lamp series provide soft no glare illumination, eliminating dark lines and shadows.



ES16/MR16 - GU10

STANDARD

PART#	WATTS	BASE	VOLTS	COLOUR	BEAM ANGLE°	AVG. LIFE	INITIAL LUMENS	NOM. LEN (INCHES)
S3500	20	GU10	120	Clear	36	2000	120	2.17
S3501	35	GU10	120	Clear	36	2000	280	2.17
S3502	50	GU10	120	Clear	36	2000	500	2.17
H20GU10/NFL/CG	20	GU10	120	Clear	25	2500	120	2.17
H35GU10/NFL/CG	35	GU10	120	Clear	25	2500	280	2.17
H50GU10/NFL/130	50	GU10	130	Clear	25	3000	375	2.17

GU10 - ICE - frosted lens . soft no glare illumination . eliminates dark lines and shadows. 

H20GU10/CG/ICE	20	GU10	120	Frost	40	2500	130	2.17
H35GU10/CG/ICE	35	GU10	120	Frost	40	2500	280	2.17
H50GU10/CG/ICE	50	GU10	130	Frost	40	3000	375	2.17

GU10 - UNI-FROST - fully frosted reflector . spills light in all directions . used in glass pendants and track heads

H35GU10/CG/UFR	35	GU10	120	Frost		2500	300	2.17
H50GU10/CG/UFR	50	GU10	130	Frost		3000	390	2.17



LED MR16 GU10 - 120V - DIMMABLE

STANDARD SATCO

PART#	WATTS	BASE	COLOUR	CRI	AVG. HRS.	INITIAL LUMENS	BEAM ANGLE	HALOGEN EQU. (W)
64634	7	GU10	3000	84	25000	563	25	50
64636	7	GU10	3000	84	25000	553	38	50
S9384	6.5	GU10	4000	80	25000	500	40	50
S9385	6.5	GU10	5000	80	25000	500	40	50









MR16

- Available in 12 volts and 120 volts
- With or without a cover glass.
- Also with specialty glass

Features

- High quality white light
- Long life
- Beam angle offered: 13° - 38°
- Available in specialty EYE and Coloured back, extra long life and Coloured glass



MR16 - E26 BASE (COVER GLASS)



PART#	WATTS	BASE	VOLTS	COLOUR	BEAM ANGLE°	AVG. LIFE	INITIAL LUMENS	NOM. LEN (INCHES)
H35MR16/FL/E26	35	E26	120	Clear	38	2000	240	2.17
H50MR16/FL/E26	50	E26	120	Clear	38	2000	420	2.17



MR16

LED MR16 - E26 BASE - 120V - DIMMABLE



PART#	DESCRIPTION	WATTS	BASE	COL.	CRI	AVG. HRS.	INITIAL LUMENS	BEAM ANGLE	HALOGEN EQU. (W)
63854	MR16 FL	7	E26	3000	80	30000	500	38	50



MR16 - 12 VOLTS



PART#	WATTS	BASE	VOLTS	COLOUR	BEAM ANGLE°	AVG. LIFE	INITIAL LUMENS	NOM. LEN (INCHES)
<i>(COVER GLASS 12V)</i>								
20MR16FL	20	GX5.3	12	Clear	38	4000	260	1.78
35MR16FL	35	GX5.3	12	Clear	38	4000	530	1.78
50MR16FL	50	GX5.3	12	Clear	38	4000	850	1.78
<i>(OPEN 12 V)</i>								
H20MR16FL/12V	20	GX5.3	12	Clear	36	4000	260	1.78
H35MR16FL/12V	35	GX5.3	12	Clear	38	4000	530	1.78
H50MR16FL/12V	50	GX5.3	12	Clear	38	4000	850	1.78
JR1502	50	GX5.3	12	Clear	24	4000	850	1.78



MR16 (GU5.3)



MR16 (GU5.3)

LED MR16 - 12V - DIMMABLE



PART#	WATTS	BASE	COLOUR	CRI	AVG. HRS.	INITIAL LUMENS	BEAM ANGLE	HALOGEN EQU. (W)
63605	7	GU5.3	3000	80	40000	520	25	50
63606	7	GU5.3	3000	80	40000	520	40	50
S9491	6.5	GU5.3	3000	80	25000	500	25	50
S9493	6.5	GU5.3	4000	80	25000	500	25	50
S9494	6.5	GU5.3	5000	80	25000	500	25	50
S9496	6.5	GU5.3	3000	80	25000	500	40	50
S9498	6.5	GU5.3	4000	80	25000	500	40	50
S9499	6.5	GU5.3	5000	80	25000	500	40	50



What is CRI?

Colour Rendering Index (CRI) is a measure of a light's ability to show object colours realistically or naturally.

- CRI Between 0 to 70 - alter our colour perception
- CRI Between 70 to 90 - display colours satisfactory
- CRI Between 90 to 100 - display colours more true to life



CHECK ONLINE BEFORE ORDERING
Are these bulbs available in your province?

PAR HALOGEN LAMPS

PAR16 (1-3/4" Dia)

STANDARD

PART#	WATTS	BASE	VOLTS	COLOUR	BEAM	BEAM ANGLE°	AVG. LIFE	INITIAL LUMENS	NOM. LEN (INCHES)
60PAR16/CAP/NFL30	60	E26	130	Clear	N. FLOOD	30	2500	650	3.23



LED PAR16 - 120V - DIMMABLE

SATCO

PART#	DESCRIPTION	WATTS	BASE	COL.	CRI	AVG. HRS.	INITIAL LUMENS	BEAM ANGLE	HALOGEN EQU. (W)
S9388	PAR16	6.5	E26	3000	80	25000	520	40	60
S9389	PAR16	6.5	E26	5000	80	25000	520	40	60



PAR16

Best Sellers

PAR20 (2-1/2" Dia)

STANDARD

PART#	WATTS	BASE	VOLTS	COLOUR	BEAM	BEAM ANGLE°	AVG. LIFE	INITIAL LUMENS	NOM. LEN (INCHES)
35PAR20CAPNF	35	E26	130	Clear	N. FLOOD	28	5000	235	3.12
50PAR20/CAP/NFL30	50	E26	130	Clear	N. FLOOD	28	5000	410	3.27

Colour models also available on request.



Same look and feel as traditional PAR lamps!

LED PAR20 - 120V - DIMMABLE - SILVER BACK - AVG LIFE: 25,000

SATCO

PART#	DESCRIPTION	WATTS	BASE	COLOUR	CRI	AVG. LIFE (HOURS)	INITIAL LUMENS	BEAM ANGLE	HALOGEN EQUIV.(W)
25° Beam									
S9401	PAR20	7	E26	3000	80	25000	525	25	50
S9403	PAR20	7	E26	4000	80	25000	525	25	50
S9404	PAR20	7	E26	5000	80	25000	525	25	50
40° Beam									
S9406	PAR20	7	E26	3000	80	25000	525	40	50
S9408	PAR20	7	E26	4000	80	25000	525	40	50
S9409	PAR20	7	E26	5000	80	25000	525	40	50

Other Colour Temps Available! Silver Back Looks Like An Traditional Bulb!



PRO PICK

LED PAR20 - 120V - DIMMABLE

40,000 HR Long Life!

STANDARD

PART#	DESCRIPTION	WATTS	BASE	COL.	CRI	AVG. HRS.	INITIAL LUMENS	BEAM ANGLE	HALOGEN EQU. (W)
63952	PAR20 NFL	7	E26	3000	93	40000	502	25	50
63955	PAR20 FL	7	E26	3000	93	40000	502	40	50
63956	PAR20 NFL	7	E26	4000	94	40000	551	25	50
63957	PAR20 FL	7	E26	4000	94	40000	551	40	50



PAR20

Beam Angles

Narrow Flood - 25°
Flood - 30-40°
Wide Flood - 40°+

NARROW BEAM ANGLE



Beam spreads at 45°. Concentrated lighting best used in task & track lighting.

MEDIUM BEAM ANGLE



Beam spreads at 60°. Medium diffused lighting best used in recessed ceiling & track lighting.

WIDE BEAM ANGLE



Beam spreads at 90°. Good diffusion of light for softer spotlight lighting.

EXTRA WIDE BEAM ANGLE



Beam spreads at 120°. Very good diffusion of light for bright whole room spotlight lighting.





PAR30SN SHORT NECK (3-3/4" Dia)



PART#	WATTS	BASE	VOLTS	COLOUR	BEAM	BEAM ANGLE°	AVG. LIFE	INITIAL LUMENS	NOM. LEN (INCHES)
75PAR30CAPFL	75	E26	130	Clear	FLOOD	40	5000	825	3.50



LED PAR30SN SHORT NECK- 120V - DIMMABLE - SILVER BACK - AVG LIFE: 25,000



PART#	DESCRIPTION	WATTS	BASE	COLOUR	CRI	AVG. LIFE (HOURS)	INITIAL LUMENS	BEAM ANGLE	HALOGEN EQUIV.(W)
25° Beam									
S9411	PAR30SN	13	E26	3000	80	25000	1000	25	50
S9413	PAR30SN	13	E26	4000	80	25000	1000	25	50
S9414	PAR30SN	13	E26	5000	80	25000	1000	25	50
40° Beam									
S9416	PAR30SN	13	E26	3000	80	25000	1000	40	50
S9418	PAR30SN	13	E26	4000	80	25000	1000	40	50
S9419	PAR30SN	13	E26	5000	80	25000	1000	40	50

Other Colour Temps Available!



PAR30SN

LED PAR30SN SHORT NECK - 120V - DIMMABLE

40,000 HR Long Life!



PART#	DESCRIPTION	WATTS	BASE	COL.	CRI	AVG. HRS.	INITIAL LUMENS	BEAM ANGLE	HALOGEN EQU. (W)
63970	PAR30NFL Short N.	10	E26	3000	94	40000	830	25	75
63972	PAR30FL Short N.	10	E26	3000	94	40000	830	40	75
63973-STD	PAR30NFL Short N.	10	E26	4000	94	40000	904	25	75
63974	PAR30FL Short N.	10	E26	4000	94	40000	904	40	75

PAR30LN - LONG NECK (3-3/4" Dia)



PART#	WATTS	BASE	VOLTS	COLOUR	BEAM	BEAM ANGLE°	AVG. LIFE	INITIAL LUMENS	NOM. LEN (INCHES)
50PAR30LN/CAP/NFL	50	E26	130	Clear	FLOOD	40	5000	495	4.53

LED PAR30LN LONG NECK- 120V - DIMMABLE - SILVER BACK - AVG LIFE: 25,000



PART#	DESCRIPTION	WATTS	BASE	COLOUR	CRI	AVG. LIFE (HOURS)	INITIAL LUMENS	BEAM ANGLE	HALOGEN EQUIV.(W)
25° Beam									
S9426	PAR30LN	13	E26	3000	80	25000	1000	25	75
S9428	PAR30LN	13	E26	4000	80	25000	1000	25	75
S9429	PAR30LN	13	E26	5000	80	25000	1000	25	75
40° Beam									
S9433	PAR30LN	13	E26	4000	80	25000	1000	40	75
S9434	PAR30LN	13	E26	5000	80	25000	1000	40	75

Other Colour Temps Available!



PAR30LN

LED PAR30LN - 120V - DIMMABLE - LONG NECK

40,000 HR Long Life!



PART#	DESCRIPTION	WATTS	BASE	COL.	CRI	AVG. HRS.	INITIAL LUMENS	BEAM ANGLE	HALOGEN EQU. (W)
63962	PAR30 NFL Long N.	10	E26	3000	94	40000	848	25	75
63963	PAR30 FL Long N.	10	E26	3000	94	40000	848	40	75
63964	PAR30 NFL Long N.	10	E26	4000	94	40000	929	25	75
63965	PAR30 FL Long N.	10	E26	4000	94	40000	929	40	75

Save energy and money! Check your local government incentive programs for energy saving rebates!





Bulbs

PAR. floods

PAR38 (4-5/8" Dia)



PART#	WATTS	BASE	VOLTS	COLOUR	BEAM	BEAM ANGLE°	AVG. LIFE	INITIAL LUMENS	NOM. LEN (INCHES)
39PAR38/HAL/NFL25	39	E26	120	Clear	N. FLOOD	25	1500	550	5.31
60PAR/CAP/FL30	60	E26SKT	130	Clear	FLOOD	36	5000	585	5.31
75PAR38HFL	75	E26SKT	130	Clear	FLOOD	36	5000	825	5.31
90PAR38HFL	90	E26SKT	130	Clear	FLOOD	36	5000	950	5.31

Colour models also available on request.



LED PAR38 - 120V - DIMMABLE - SILVER BACK - AVG LIFE: 25,000



PART#	DESCRIPTION	WATTS	BASE	COLOUR	CRI	AVG. LIFE (HOURS)	INITIAL LUMENS	BEAM ANGLE	HALOGEN EQUIV.(W)
25° Beam									
S9441	PAR38	15	E26	3000	80	25000	1200	25	90
S9443	PAR38	15	E26	4000	80	25000	1200	25	90
S9444	PAR38	15	E26	5000	80	25000	1200	25	90
40° Beam									
S9446	PAR38	15	E26	3000	80	25000	1200	40	90
S9448	PAR38	15	E26	4000	80	25000	1200	40	90
S9449	PAR38	15	E26	5000	80	25000	1200	40	90

Other Colour Temps Available!



PAR38

LED PAR38 - 120V - DIMMABLE

40,000 HR Long Life!



PART#	DESCRIPTION	WATTS	BASE	COL.	CRI	AVG. HRS.	INITIAL LUMENS	BEAM ANGLE	HALOGEN EQU. (W)
63979	PAR38 NFL	15	E26	3000	94	40000	1115	25	100
63980	PAR38 FL	15	E26	3000	94	40000	1115	40	100
63981	PAR38 NFL	15	E26	4000	94	40000	1215	25	100
63982	PAR38 FL	15	E26	4000	94	40000	1215	40	100



LED PAR38 HI PRO- 100-277V - NON-DIMMABLE - AVG LIFE: 50,000



PART#	DESCRIPTION	WATTS	BASE	COLOUR	CRI	INITIAL LUMENS	BEAM ANGLE	HID EQUIV.(W)
S9760	PAR38	18	E26	3000	83	1950	25	70
S9761	PAR38	18	E26	4000	83	2000	25	70

Save time and energy and switch to LED!
With longer life spans than traditional incandescent or halogen, you won't have to change as often!

NEW LEDs can even be used outdoors!





High Pressure Sodium & Metal Halide- Bulbs/Ballasts



SUNLUX® - HIGH PRESSURE SODIUM LAMPS - MEDIUM BASE

Burning Position: Universal - Medium Base

PART#	BULB	DES.	WATTS	AVG. LIFE	LUMENS	ANSI
LU35/MED	ED17	Clear	35	16000	2250	S76HA-35
LU50/MED	ED17	Clear	50	24000+	4000	S68LP-50
LU70/MED	ED17	Clear	70	24000+	6300	S62LG-70
LU100/MED	ED17	Clear	100	24000+	9500	S54SG-100
LU150/MED	ED17	Clear	150	24000+	15800	S55RN-150



COMPACT METAL HALIDE LAMPS - MEDIUM BASE - ENCLOSED FIXTURES

Burning Position: Universal - Medium Base

PART#	BULB	COLOUR	WATTS	AVG. LIFE	LUMENS	ANSI
MH50/U/MED	ED17	Clear	50	10000	3400	M110TM-50
MH70W/U/PS	ED17	Clear	70	15000	5600	M98SJ-70
MH100/U/MED	ED17	Clear	100	15000	9000	M90TW-100
MH150/U/MED	ED17	Clear	150	15000	14000	M107TS-150
MH175/U/MED	ED17	Clear	175	10000	14000	M57-175

Must be installed in enclosed fixtures

STANDARD METAL HALIDE LAMPS - MOGUL BASE - ENCLOSED FIXTURES

Burning Position: Universal

PART#	BULB	COLOUR	WATTS	AVG. LIFE/HRS.	LUMENS	ANSI
MH175/U	ED28	Clear	175	10000	14400	M57PF-175
MH250/U	ED28	Clear	250	10000	21000	M58PH-250
MH400/U	ED28	Clear	400	20000	36000	M59PK-400

Must be installed in enclosed fixtures

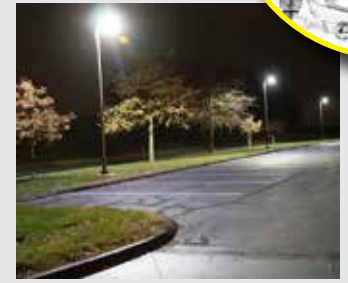

There are now **affordable LED** energy saving solutions for **most HID light fixtures!**

- Save more than **50% on energy**
- Save labor on lamp changes
- Direct replacements
- **New LED lamp** replacement options

Upgrade to **affordable LED replacement fixtures or lamps** today!

Call AMRE for an onsite energy audit



Hi-Pro Wall Pack Series

For use in wall pack, canopy, shoebox or cobra head fixtures

- Replaces HID, 180° Beam
- Direct wire range voltage 100-277V
- Approved for totally enclosed fixtures
- IP64 rated
- Horizontal operation
- 5 Year limited warranty



Hi-Pro LED WALL PACK SERIES - E26 Medium or E39 Mogul Base Options

PART#	WATTS	BASE	COLOUR TEMP.	AVG. LIFE/HRS.	LUMENS	REPLACES	M.O.L
S8905	20	E26	5000K	50000	2800	100w	7-1/8"
S8907	30	E26	5000K	50000	4300	150w	8-1/8"
S8909	30	E39	5000K	50000	4300	150w	8-11/16"
S8925	40	E26	5000K	50000	5600	175w	9-7/8"
S8927	40	E39	5000K	50000	5600	175w	10-5/8"

Hi-Pro LED

High lumen, omni-directional lamps for industrial and commercial applications

- Replaces HID, CFL, and Incandescent
- Direct wire range voltage 100-277V
- Approved for totally enclosed fixtures
- IP65 rated
- Base up, base down or horizontal operation
- 5 Year limited warranty

***** Important *****
When replacing HID 100-270V
a ballast bypass is necessary.



High Lumen Industrial/Commercial LED Lamps, 100-277 Volts

PART#	WATTS	BASE	COLOUR TEMP.	AVG. LIFE/HRS.	LUMENS	REPLACES	M.O.L
S9390	18	E26	5000K	50000	2400	70-120	6-7/8"
S9391	22	E26	5000K	50000	2950	100-150	7-11/16"
S29392	36	E26	5000K	50000	4800	150-200	9-1/4"
S9393	45	EX39	5000K	50000	6000	175-300	10-3/4"
S9394	54	EX39	5000K	50000	7200	250-300	10-3/4"
S9395	80	EX39	5000K	50000	10640	320-400	9-1/4"
S9396	100	EX39	5000K	50000	13300	400-500	9-5/8"
S9397	120	EX39	5000K	50000	16000	600-750	10-3/8"

Also available in 277-347V

Save energy and money! Check your local government incentive programs for energy saving rebates!

Features

- Replaces HID, CFL, and Incandescent
- Direct wire range voltage 100-277V
- Approved for totally enclosed fixtures
- Hi bay, low bay and post top
- Light panels lock into place creating 3 separate beam angle options
- IP65 rated
- 5 year limited warranty



LED HID REPLACEMENT HI PRO- 100-277V - **NON-DIMMABLE**, AVG LIFE: 50000

PART#	DESCRIPTION	WATTS	BASE	COLOUR	CRI	INITIAL LUMENS	BEAM ANGLE	HID EQUIV.(W)
S9750	HID	30	E26	5000	80+	3900	180/270/360	200
S9751	HID	40	EX39	5000	80+	5200	180/270/360	300
S9752	HID	60	EX39	5000	80+	7800	180/270/360	500

Light Panels Move Creating 3 Beam Angle Options!



Fuses - NRN, GP, S / Photocells / Timers

NRN Fuses - Class H/250 Volts A.C. / Fast Acting



- Fast Acting
- Ampere Ratings 1-600 Amps
- Interrupting Rating 10ka RMS Sym.
- CSA certified to Standard 248.6

- UI Listed to Standard 248.6
- P Rating for NRN 15/20/25/30/35/40/45/50/60
- Replaces following NON-Buss, NLN-Littlefuse, EON-Reliance

Part#	AMP	Body Size
250V		
NRN10	10	30A
NRN15	15	30A
NRN20	20	30A
NRN25	25	30A
NRN30	30	30A

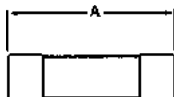

Body Size 30A A = 2" (51mm) C = 9/16" (14mm)



Part#	AMP	Body Size
250V		
NRN35	35	60A
NRN40	40	60A
NRN45	45	60A
NRN50	50	60A
NRN60	60	60A

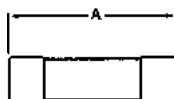

Body Size 60A A = 3" (76mm) C = 13/16" (21mm)



Part#	AMP	Body Size
250V		
NRN70	70	100A
NRN80	80	100A
NRN90	90	100A
NRN100	100	100A

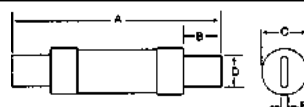

Body Size 100A A 5-7/8" (149mm) B 1" (25mm) C 1-1/16" (27mm) D 3/4" (19mm) E 1/8" (3mm)



Range Fuses

GOULD SHAWMUT Sold Individually



GP Appliance Fuses	Gould Rating	Per. Carton
G3	3	50
GP15	15	50
GP20	20	50
GP25	25	50
GP30	30	50

GOULD SHAWMUT Sold Individually

Sold Individually



Fusestats (Type S)	Gould Rating	Per. Carton
626-10S	10A	4
S15	15A	4
626-20S	20A	4



GOULD SHAWMUT

GGC2	2 amp
GGC3	3 amp
GGC5	5 amp
GGC10	10 amp
GGC15	15 amp

Fast acting glass tube fuses, 250v.

Other fuses available on our website.



WG02F05535 15 amp
WG02F00096 20 amp
250V Ceramic fast acting glass fuses, most commonly used in microwaves



ATO-3 3A - Violet
ATO-5 5A - Tan
Standard blade fuse. Used in many furnaces.



ATM-3 3A - Violet
Fast acting blade Mini-Fuse.



DO MORE
AMRE SUPPLY
Property Performance Centres

Check out our website for a full line of Breakers and Panels! or give us a call!
www.amresupply.com



OT/OTS Fuses



General Purpose Fast Acting
OT - 250V A.C.
OTS - 600V A.C.

- Features:**
- Amp ratings 1 - 600 amps
 - Interrupting rating 50 kA RMS Sym

TR/TRS Fuses



Time Delay - SmartSpot
Tri-ionic Type TR - 250V A.C
Tri-ionic Type TRS - 600V A.C

General Application:
Class RK5 fuses are rejection fuses used to give better protection in existing Class H & K5 fuse equipment. Safely handles harmless starting currents and inrush currents associated with today's motors and transformers.

AJT Fuses



Time Delay
SmartSpot Indicator
AMP-TRAP 2000

General Application:
Class J fuses provide both overload and short circuit protection. Time delay Class J is more universal. Used for IEC Type 2 "no damage" motor protection.





P-RBS 22-18 (100/pkg)
P-BBS 16-14 (100/pkg)
P-YBS 12-10 (75/pkg)
 Butt connector, vinyl



P-HS-RBS 22-18 (25/pkg)
P-HS-BBS 16-14 (25/pkg)
P-HS-YBS 12-10 (25/pkg)
 Heat shrinkable step down butt connectors.



P-COM-12/8 12-8 (25/pkg)
 Compressor Terminal.



P-COM-LEADS-8
 10 AWG 8"
 Compressor Hook Up Lead Kit.



P-HT-BFF-250 Flag
P-HT-BQDF-250 Straight
 High Temperature quick disconnect. Female. 16-14, .250" (100/pkg)

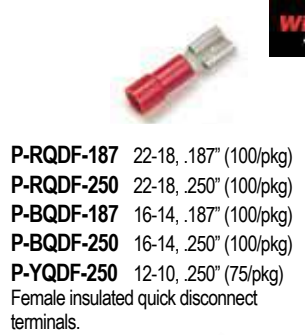

P-RQDF-187 22-18, .187" (100/pkg)
P-RQDF-250 22-18, .250" (100/pkg)
P-BQDF-187 16-14, .187" (100/pkg)
P-BQDF-250 16-14, .250" (100/pkg)
P-YQDF-250 12-10, .250" (75/pkg)
 Female insulated quick disconnect terminals.

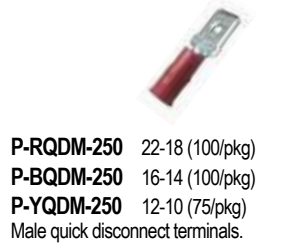

P-RQDM-250 22-18 (100/pkg)
P-BQDM-250 16-14 (100/pkg)
P-YQDM-250 12-10 (75/pkg)
 Male quick disconnect terminals.



P-NBQDM-FI-250 16-14 Male .250" (40/pkg)
P-NBQDF-FI-250 16-14 Female .250" (40/pkg)
 Quick disconnect terminals, nylon, fully insulated.



P-RS6 22-18, #6 (100/pkg)
P-RS10 22-18, #10 (100/pkg)
P-BS6 16-14, #6 (100/pkg)
P-BS10 16-14, #10 (100/pkg)
P-YS10 12-10, #10 (75/pkg)
 Block spade tongue terminals. Vinyl insulated.



P-RQDF/M 22-18 (30/pkg)
P-BQDF/M 16-14 (30/pkg)
 Multi-Stack Disconnect Terminals. .250" width.



P-NRF-FI-250 22-18 .250" (50/pkg)
P-NBF-FI-250 16-14 .250" (50/pkg)
P-NYF-FI-250 12-10 .250" (30/pkg)
 Nylon fully insulated female quick disconnect flag terminals.

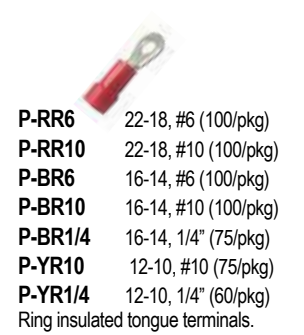

P-RR6 22-18, #6 (100/pkg)
P-RR10 22-18, #10 (100/pkg)
P-BR6 16-14, #6 (100/pkg)
P-BR10 16-14, #10 (100/pkg)
P-BR1/4 16-14, 1/4" (75/pkg)
P-YR10 12-10, #10 (75/pkg)
P-YR1/4 12-10, 1/4" (60/pkg)
 Ring insulated tongue terminals.



P-DMF-F Flat (60/pkg)
P-DMF-PB Piggy back (40/pkg)
 Double Male-Female adapter terminals, .250".



25-002
 Solderless Terminal Kit 450 pcs. of most popular spade, ring, butt, male and female 22-10 sizes.



P-WC-GREY 22-14 Grey (100/pkg)
P-WC-BLUE 22-14 Blue (100/pkg)
P-WC-ORANGE 22-14 Orange (60/pkg)
P-WC-YELLOW 22-10 Yellow (50/pkg)
P-WC-RED 22-8 Red (35/pkg)
 Twist-On wire connector. Sure grip 600V

Large Jars
WCB-J300 22-14 Blue (300/jar)
WCO-J300 22-14 Orange (300/jar)
WCY-J200 22-10 Yellow (200/jar)
WCR-J125 22-8 Red (125/jar)



25-010
 22-8 AWG Twist on Wire Connector Kit 375 pcs.



P-TEW16/26-R 16/26 - Red
P-TEW16/26-B 16/26 - Black
P-TEW14/41-W 14/41 - White
P-TEW14/41-R 14/41 - Red
P-TEW14/41-B 14/41 - Black
P-TEW12/65-B 12/65 - Black
 Thermoplastic equipment wire. PVC 600V, 105°C (221°F), 100ft/pkg. insulated.



P-CES22/14 22-14 (100/pkg)
P-CES-16/10 16-10 (60/pkg)
 Closed End Connector.



CTMBR3/4-0-Q .74", #4 Screw (25/pkg)
CTMBR1-0-Q .99", #6 Screw (25/pkg)
 Rubber adhesive cable tie mounting base, .20" slot, natural.



CT0850MH-0-C Natural (100/pkg)
CT0850MH-X-C Black (100/pkg)
 Cable ties with mounting hole. 8" 50 lb



Natural (100/pkg each)
CT0540ST-0-C 5.8" 40 lb
CT0750ST-0-C 7.5" 50 lb
CT1150ST-0-C 11.2" 50 lb
CT1450ST-0-C 14.5" 50 lb
Black (100/pkg each)
CT0540ST-X-C 5.8" 40 lb
CT0750ST-X-C 7.5" 50 lb
CT1150ST-X-C 11.2" 50 lb
CT1450ST-X-C 14.5" 50 lb
Black (1000/pkg each)
CT0750ST-X-M 7.5" 50 lb
CT1150ST-X-M 11.2" 50 lb
 Cable ties.
 40lbs or 50lbs strength

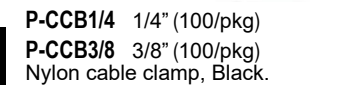

P-CCB1/4 1/4" (100/pkg)
P-CCB3/8 3/8" (100/pkg)
 Nylon cable clamp, Black.



Pro Quality



AT-RACT
22-10 AWG Ratchet action crimp tool for insulated terminals

Pro Quality



AT-RACT-F
22-14 AWG Ratchet action crimp tool for insulated flag terminals

Pro Quality



AT-WS
24-10 AWG Heavy duty wire stripper & cutter

Pro Quality



MG-1400
18-250LB Cable tie removal tool & wire stripper

NMD90 - Loomex (Romex) Cable

Residential wiring used for outlets, switches and other loads in exposed and concealed work in dry locations.

- 14/2NMD7 14/2 per/M
- 14/2NMD7P75 14/2 75M roll
- 14/3NMD7 14/3 per/M
- 14/3NMD7P75 14/3 75M roll
- 14/2BLUENMDX150 14/2 150M roll
- 12/2NMD7 12/2 per/M
- 10/3NMD7 10/3 per/M
- 8/3NMD7 8/3 per/M



GS-366
Crimping Tool Cuts Wire -Strips Wire -Cuts Bolts Crimps Terminals. Insulated/Non- Insulated, Cushioned Handles

KLEIN TOOLS



1011K
Multi-Purpose Wire Stripper/Cutter

AC90 Armoured Cable (BX) - Copper building wire with Aluminium interlocking armour. Used as feeder and service power distribution in commercial, industrial and multi-residential buildings.

- 14/2AC90 14/2 per/M
- 14/2AC90X75 14/3 75M roll
- 14/3AC90 14/3 per/M
- 14/3AC90X75 14/3 75M roll
- 12/2AC90 12/2 per/M
- 12/3AC90 12/3 per/M
- 10/2AC90 10/2 per/M
- 10/3AC90 10/3 per/M



P-SC2038 (L51) 3/8"
14/2-10/2, 14/3-10/3
C1806 (L104) 3/4"
8/2-6/2, 14/3-8/3
Loomex NMD90 Connector, 2 screws



L16
Box Clamp 3/8" One Screw Connector, Loomex or AC90 14/2-10/2, 14/3-12/3 NMD90, 14/4-12/4 AC90

Ethernet/Phone Wire - Sold by Roll Only - some locations may stock per meter



Part#	Description	Size
24/4CAT5E	Ethernet/Phone 24 AWG, 4 pr	305M
24/4CAT6	Ethernet/Phone 24 AWG, 4 pr	305M
RG6U-FT4	Coax video cable RG6	305M

C12210 3/8"
14/2-10/2, 14/3-10/3, 14/4-12/4
C12214 3/4"
6/2-4/2, 8/3-3/3, 8/4-6/4
AC90 armoured cable connector, 90°, 2 screws

DE-OX-40Z
Anti-oxidant and anti-seizing compound improves efficiency and service life of aluminium electrical applications. Suspended zinc particles penetrate and cut aluminium oxide.



90001-WH
4" Round cover plate, white



FST
Car Plug Double Head
2" Hub Open
4 1/8" X 4 3/8" X 3 5/8"



FSF
Single Car Plug 2" Hub Closed
4 1/8" X 4 3/8" X 3 5/8"



BC52151-K
1 1/2" Deep
BC52171-K
2 1/8" Deep
4" Square Box, Concentric Knockouts



BC53151-K
1 1/2" D
BC53171-K
2 1/8" D
4" Square Box Extension Concentric Knockouts

Thomas & Betts 3" Deep



BC1004-LH
3" X 2" X 3"D P Tabs Gangable Armoured and Non-Metallic cable

3" Deep



BC1004-L
3" X 2" X 3"D Flush Mount Gangable Armoured and Non-Metallic cable

2 1/2" Deep



BC1104-LHT
3" X 2" X 2-1/2"D P Tabs Gangable Armoured and Non-Metallic cable

2 1/4" Deep

















BC777-LRB
Raintight while-in-use. Easy Box, Rectangular Rework Box Switch or Plug 2-1/2"D



CISBEX
2" X 3" Switch Box Extension. Max. Adjustable Depth is 7/8"



<p>1/2" Deep</p>  <p>BC56111 4" Ceiling pan, 1/2" D</p>	 <p>BC54151-K 1-1/2" D BC54171-K 2-1/8" D Raintight while-in-use. 4" Octagon Box, 1/2" & 3/4" Concentric Knockouts</p>	<p>1-1/2" Deep</p>  <p>BC54151-L 4" Octagon box 1/2" Concentric Knockouts.</p>	<p>New! 1-1/2" Deep</p>  <p>BC54151-LD 4" Octagon box with rework brackets, 1/2" Concentric Knockouts</p>	<p>AMRE in partnership with Standard have over 25 yrs. experience in providing energy efficient light solutions. Call us today for a free on-site consultation!</p>
<p>1/2" Deep</p>  <p>OBEX 4" Octagon Box, Extension ring, 1/2" D</p>	 <p>BC55151-K 1-1/2" Deep BC55171-K 2-1/8" Deep Raintight while-in-use. 4" Octagon Box extension rings</p>	<p>2-1/8" Deep</p>  <p>BC72171-K 4-11/16" Square. Range & Dryer Box, 2-1/8"D</p>	 <p>BC73151-K 1-1/2" D BC73171-K 2-1/8" D Raintight while-in-use. 4 11/16" Extension Ring for 72171K Box</p>	 <p>BC1110 Raintight while-in-use. 4" X 2 3/8" X 1-7/8"D Utility Box, raised grd screw</p>
<p>1/2" Knock Out</p>  <p>BC54-C-6 4" Box cover</p>	 <p>BC52-C-6 Knockout BC52-C-1 Blank 4" Box Cover</p>	 <p>BC11-C-4 Blank Plate for 1110 Box</p>	 <p>BC11-C-5 Single Switch Plate for 1110 Box</p>	 <p>BC11-C-1 Duplex Plate for 1110 Box</p>



Less Time Charging. More Time Connected! **ZAP!** **LEVITON**

Charge multiple devices easily with Leviton's New Receptacles! USB Ports are controlled by a smart chip which recognizes and optimizes the charging power of your device. Spend less time charging and more time enjoying your device!



T5631-2W
Decora 2 USB/1 Receptacle
- 15A/125V Receptacle
- 3.6A ground-breaking USB charging power
- Smart-chip optimizes charge power for safe fast charging of any USB device
- Tamper resistant, wallplate sold sep.



T5632-W
Decora 2 USB/2 Receptacle
- 15A/125V Receptacles
- 3.6A ground-breaking USB charging power
- Smart-chip optimizes charge power for safe fast charging of any USB device
- Tamper resistant, wallplate sold sep.



New!



T5832-HGW
Hospital Grade Tamper-Resistant.
Decora 2 USB/2 Receptacle
- 20A/125V Receptacles
- Impact and chemical resistant PBT face provides longer service life
- Smart-chip optimizes charge power for safe fast charging of any USB device
- Compact design fits in a standard wallbox





Standard
5320-I Ivory
5320-W White

Tamper Resistant
T5320-I Ivory
T5320-W White

Aluminium Wire Only
12650-I Ivory
12650-W White
 Side Wired & Quick Wire
 15A/125V NEMA 5-15R

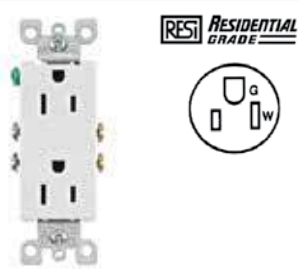

Standard
5325-I Ivory
5325-W White

Tamper Resistant
T5325-I Ivory
T5325-W White
 Decora Side Wired & Quick Wire
 15A/125V NEMA 5-15R



CR20-I Ivory
CR20-W White
 Side Wired Duplex Receptacle
 20A/125V T-Slot version
 NEMA 5-20R. Commercial
 Grade

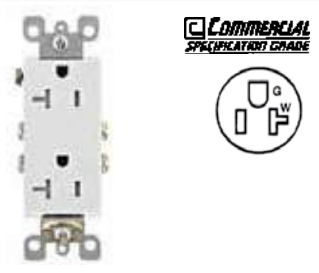

Standard
DR20-I Ivory
DR20-W White

Tamper Resistant
T5825-I Ivory
T5825-W White
 Decora Side Wired & Quick Wire
 20A/125V NEMA 5-20R



LED Guide Light!
 Sensor LED turns off and on automatically for safety in the dark!

T6525-W White
 Decora Tamper-Resistant Receptacle with LED Sensor Guide Light 15A/125V



LED Guide Light!
 Sensor LED turns off and on automatically for safety in the dark!

GFNL1-W White
 Decora GFCI Tamper-Resistant Receptacle. SmartlockPro with LED Sensor Guide Light 15A/125V, cover sold separate

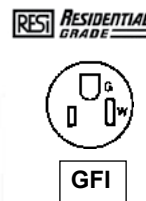

Standard
GFNT1-I Ivory
GFNT1-W White

Tamper Resistant
GFTR1-I Ivory
GFTR1-W White
 Decora GFCI Receptacle, with LED indicator light **15A/125V**, NEMA 5-15R, cover included. 20Amp feed through. SmartLock Pro self testing

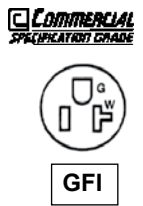

Standard
GFNT2-I Ivory
GFNT2-W White

Tamper Resistant
GFTR2-I Ivory
GFTR2-W White
 Decora GFCI Receptacle, with LED indicator light **20A/125V**, Nema 5-20R, cover included. 20Amp feed through. SmartLock Pro self testing



GFSW1-W White
 Decora Combo GFCI and Switch Tamper-Resistant 15A/125V



AFRBF-W White
 Arc Fault Circuit Interrupter Decora, 125V, 20Amp feed through, 2Pole, 3 Wire, self grounding clip incl., 1HP, back & side wired



45126
 Flush Mount Range Receptacle, 3 pole, 4 wire, grounding 50A/120-240V NEMA 14-50R



45125
 Flush mount Dryer Receptacle, 3 pole, 4 wire grounding 30A/120-240V NEMA 14-30R



5225-I Ivory
5225-W White
 Combination Switch, 15 Amp 120V, 1/2 H.P.@ 120V Switch, 15A/125V Grounding Receptacle



5625-I Ivory
5625-W White
 Decora Combination Single Pole Switch & Receptacle 15A/125V. C/W cover.





5224-I Ivory
5224-W White
 Combination Switch, 2 single Pole 15 Amp 120/277V AC 1/2 H.P.@ 120V, 2 H.P. @ 240V



Standard Single Pole
1451-I Ivory
1451-W White
For Aluminium Wiring Single Pole
2651-2I Ivory
2651-2W White
 Single Pole Quickwire and Side Wired Framed Toggle, 15A/120V Quiet Switch

3-Way



Standard 3-Way
1453-I Ivory
1453-W White
For Aluminium Wiring 3-Way
2653-2I Ivory
2653-2W White
 3-Way Quickwire and Side Wired Framed Toggle, 15A/120V Quiet Switch



1201-2IL Ivory
1201-2L Brown
 Locking Single Pole Switch, Side Wired 120/277V AC, 15 Amp



55500-PRT
 Key for Locking Switch



Perfect for hospitality suites



Standard Single Pole
5611-2I Ivory
5611-2W White
3-Way
5613-2I Ivory
5613-2W White
 Decora AC Quiet Quickwire and Side Wired 120/277V AC, 15 Amp Single Pole, Lense illuminated when off



Standard Single Pole
5601-I Ivory
5601-W White
3-Way
5603-I Ivory
5603-W White
4-Way
5604-2I Ivory
5604-2W White
 Decora AC Quiet quickwire Push-in & Side Wired 120/277V AC, 15 Amp Single Pole



For Gas Fireplaces



5691-2I Ivory
5691-2W White
 Decora AC Quiet Back and Side Wired 120/277V AC, 15 Amp Single Pole



5634-I Ivory
5634-W White
 Decora Combination Single Pole & Single Pole 15A/120/277V

LED Guide Light!

Sensor LED turns off and on automatically for safety in the dark!



6626-W White
 Decora Single Pole Switch with LED Sensor Guide Light 15A/120V



6633-PLI Ivory
6633-PLW White
 Single Pole or 3 Way Slide Dimmer, illuminated with preset on/off switch, incandescent, 600W/120V



6681-W White
 Single Pole Push-On/Push-Off, Full Range Rotary Dimmer, 600W/120V



26115-I Ivory
26115-W White
 Replacement Rotary Dimmer Knobs. For 6681-W



6674-P0W White
 Leviton SureSlide Dimmer. Single Pole or 3 Way Slide Dimmer, 600W Incandescent, 150W LED/CFL, 120VAC. Wide dimming range.

Good for these bulbs!



DSL06-1LZ 1/pk
DSL06-PK2 2/pk
 Leviton RockerSlide Dimmer. Single Pole or 3 Way Slide Dimmer, 600W Incandescent, 300W LED/CFL, 120VAC. Wide dimming range. Includes white, ivory, and light almond color kits.

Good for these bulbs!



DSM10-1LZ
 Leviton RockerSlide Dimmer. Single Pole or 3 Way Slide Dimmer, 1000W Incandescent, 450W LED/CFL, 120VAC. Wide dimming range. Includes white, ivory, and light almond color kits.

Good for these bulbs!



Wireless Control Solutions

Ask us today how we can help review your facility and provide a now easier than ever energy saving solution!



Automated Home Lighting Made Easy.

LEVITON

The Leader in Smart Home Lighting

New!

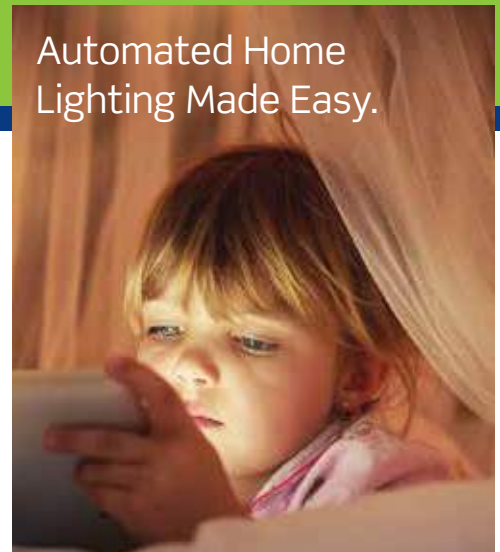

WIFI TECH

Wifi enabled models have unlimited range

Works with Amazon Alexa, Google Assistant, & Nest



DW15S-1BZ 15A Decora Smart Wifi Switch. Control your lights from anywhere using the My Leviton app, no hub required. 1800W Incandescent, 600W LED/CFL, 120VAC. Incl. white & light almond color kits

Works with Apple HomeKit



DH15S-1BZ 15A Decora Smart Wifi Switch w/ HomeKit Technology. Apple iOS enabled. Control your lights from anywhere using the Smart Home app, no hub required. 1800W Incandescent, 600W LED/CFL, 120VAC. Includes white and light almond color kits

Works with Amazon Alexa, Google Assistant, & Nest



DW6HD-1BZ 600W
DW1KD-1BZ 1000W Decora Smart Dimmer. Schedule lights and connected loads to turn on/off at specific times or based on sunrise/sunset. 1000W Incandescent, 450W LED/CFL, 120VAC. Incl. white and light almond color kits

Works with Amazon Alexa, Google Assistant, & Nest



DW3HL-1BW Smart Wifi Plug-In Dimmer, 2 Prong. Control plugged in fixtures easily from anywhere. 300W Incandescent, 100W LED/CFL, 120VAC. For use with 2 prong plugs

Works with Amazon Alexa, Google Assistant, & Nest



DW15A-1BW Smart Wifi Plug-In Dimmer, 3 Prong. Automate and control small appliances, fans, and motors. Rated for motor loads up to 1/2 HP including appliances, lamps, fans, fountains and more. 300W Incandescent, 100W LED/CFL, 120VAC. For use with 3 prong plugs

BLUE TOOTH

Bluetooth enabled models have 30-foot range



DDL06-BLZ Decora Digital Dimmer & 24 Hour Timer. Astronomical clock adjusts to sunrise/sunset. Single pole/3-way. 300W LED and CFL, 600W Incandescent. Includes white, ivory, and light almond color kits



DDE06-BLZ Decora Digital Elec Low Voltage Dimmer. Single pole/3-way. 600W Electronic Low Voltage, 300W LED and CFL, 600W Incandescent. Includes white, ivory, and light almond color kits

Dual Voltage



DDS15-BDZ Decora Digital Switch & 24 Hour Timer. Flexibility to program timed events. Single pole/3-way control. 1800W Incandescent, 15A Fluor (120V), 6A Fluor (277V), 600W LED/CFL, 15A Resistive, 1/2 HP Motor. Includes white and light almond color kits



DDF01-BLZ Decora Digital Fan Speed Switch. Ability to set maximum fan speed level for energy savings. Single pole/3-way control. Fan load, 1.5 amps, 120VAC. Includes white, ivory, and light almond color kits



DD710-BDZ Decora Digital Fluor Ballast & LED Power Supply Dimmer. Electronic 0-10VDC Fluorescent and 0-10VDC LED Power Supply. 8A (120V) 950VA, 5A (277V) 1350VA. Includes white, ivory, and light almond color kits

LEVITON
5 YEAR WARRANTY

Adding convenience, energy savings and safety to your home or business is EASY with Decora Digital.

Engineered with advanced technology to function with low wattage LED's



Motion Sensors

RESI RESIDENTIAL GRADE



Part#	Incan. Watts	LED	CFL	Motor	Ballast
IPS02-1LW*	300W	150W	150W	1/6hp	200VA
IPS06-1LW	600W	150W	-	-	-
IPS15-1LZ	1800W	600W	600W	1/2hp	1800VA

Motion Sensor, single pole & 3-Way, 30s - 30m adjustable time delay, 180°. field, 900 sq. ft. coverage, white and 120VAC, 60Hz. Resistive 2.5 amps. *Single pole only.

Honeywell



HVC0001
Honeywell Digital Bath Fan Control, White. Timer made up to 60 min or program to come on and off at certain times of day. replaces normal switch operations manually or programming

Honeywell



PLS730B1003
Honeywell EconoSwitch Programmable Timer. White. 7-day program. Control incan., halogen, fluorescent, ballasts, and motors.

LEVITON
"Humidity Sensor"



IPHS5-1LW
Humidity Sensor and Fan Control Adjustable Humidity, sensitivity and time-out control. Single pole, 1/6HP motor, 120V, 400VA, 600W-INCAN, 150W-LED/CFL

COMMERCIAL SPECIFICATION GRADE



4976-GY Grey
Thermoplastic Weather Resistant Cover Duplex Receptacle or Combination Device, 2 Independent Self Closing Lids, Horizontal

COMMERCIAL SPECIFICATION GRADE



4996-GY Grey
Thermoplastic Weather Resistant Cover Decora/GFCI 1 gang Self Closing Lid, Horizontal

RESI RESIDENTIAL GRADE



80401-I Ivory
80401-W White
Decora plastic standard Size Wallplate 1 Gang

"Oversized"
Perfect for covering up imperfections



86601 Ivory
86601 White
Decora 1 gang oversized cover plate. 3-1/2"W x 5-1/4"H

RESI RESIDENTIAL GRADE



80409-I Ivory
80409-W White
Decora plastic standard size wallplate 2 Gang

RESI RESIDENTIAL GRADE

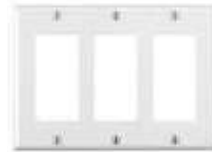

80411-I Ivory
80411-W White
Decora plastic standard size wallplate 3 gang

RESI RESIDENTIAL GRADE



80412-I Ivory
80412-W White
Decora plastic standard size wallplate 4 gang

COMMERCIAL SPECIFICATION GRADE
"Nylon"



80405-I Ivory
80405-W White
Decora GFCI and toggle switch wallplate, standard size

RESI RESIDENTIAL GRADE



80455-I Ivory
80455-W White
2 gang combo cover. 1 duplex and 1 decora

COMMERCIAL SPECIFICATION GRADE



80414-I Ivory
80414-W White
Decora blank wallplate adapter

RESI RESIDENTIAL GRADE

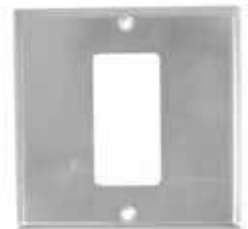

6198-W White
6198-CR Chrome
Steel razor to GFCI plug outlet conversion plate. 4-1/2" x 4-1/2"



Grade Specifications

Leviton: Industrial, Commercial and Residential. The groups represent their amperage and voltage from highest to lowest (some product classes may have slight differences).

INDUSTRIAL SPECIFICATION GRADE

COMMERCIAL SPECIFICATION GRADE

RESI RESIDENTIAL GRADE

LEVITON

COMMERCIAL
SPECIFICATION GRADE



86014 Ivory
88014-W White
84014 S. Steel
1 Gang/1 Blank

COMMERCIAL
SPECIFICATION GRADE



86001 Ivory
88001 White
1 Gang/1 Toggle

COMMERCIAL
SPECIFICATION GRADE

"Oversized"
Perfect for
covering up
imperfections



86101 Ivory
88101L White
1Gang/1 Toggle Oversized Plate
3-1/2"W x 5-1/4"H

COMMERCIAL
SPECIFICATION GRADE



86009 Ivory
88009 White
2 Gang/2 Toggles

COMMERCIAL
SPECIFICATION GRADE



86011 Ivory
88011 White
3 Gang/3 Toggles

COMMERCIAL
SPECIFICATION GRADE



86012 Ivory
88012 White
4 Gang/4 Toggles

COMMERCIAL
SPECIFICATION GRADE



86005 Ivory
88005 White
2 Gang/1 Toggle-1 Duplex

COMMERCIAL
SPECIFICATION GRADE



86003 Ivory
88003 White
84003 S.Steel
1 Gang/1 Duplex

COMMERCIAL
SPECIFICATION GRADE

"Oversized"



86103 Ivory
88103 White
1 Gang/1 Duplex Over-
sized Plate
3-1/2"W x 5-1/4"H

COMMERCIAL
SPECIFICATION GRADE



86016 Ivory
88016 White
2 Gang/2 Duplex

COMMERCIAL
SPECIFICATION GRADE



86006 Ivory
88006 White
2 Gang combo cover.
1 Toggle and 1 blank

COMMERCIAL
SPECIFICATION GRADE



86008 Ivory
88008 White
2 Gang combo cover.
1 Duplex and 1 blank

COMMERCIAL
SPECIFICATION GRADE



86018 Ivory
88018 White
1 Gang/Phone-Cable .406"
hole, Strap Mount with
knockout to enlarge hole
to .625"

phone covers



40249-I Ivory/4 conductor
40249-W White/4 conductor
Standard Flush Mount Telephone
Wall jack Smooth Finish



Remodel cover
only covers "old
style" Nortel wall
jacks

DP440-02 White
Remodeling cover only

cable covers



40981-I Ivory
40981-W White
Standard Flush mount
F-Connector cable Jack



40681-I Ivory
40681-W White
Decora single F-Connector
cable for CATV or other video
applications



Looking for specialty cord ends? We have them! www.amresupply.com



P010752
Heavy Duty Triple Cord Adapter.
15A, 125V, 60HZ, 1875W



101-EP Male, Black
101-WP Male, White
102-EP Female, Black
Cord Caps 2 Prong Plug End



515AN White
15 Amp/125V, PVC Angle
Grounding Plug, 2 pole-3 wire
Grounding .245"-.655" cord dia.
18-3 to 12-3 wire gauge Nema
5-15P



515PV-LIT Male
515CV-LIT Female
Lighted Cord Ends. 15 Amp
Commercial Grade. PVC
Straight blade, 125V, NEMA
5-15P/R, .245-.655 18-12 AWG

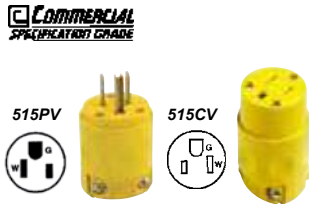

515PV Male
515CV Female
15 Amp Commercial Grade. PVC
Straight blade, 125V, NEMA
5-15P/R .245-.655 18-12 AWG

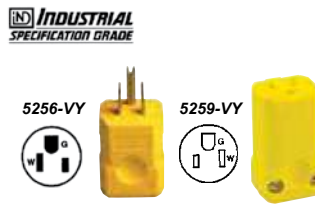

5256-VY Male
5259-VY Female
15 Amp Python Industrial Grade.
Nylon Straight blade, 125V,
NEMA 5-15P/R .245-.700 18-10
AWG Hinged Design



5266-C Male
5269-C Female
15 Amp Python Industrial Grade.
Nylon Straight blade, 125V, NEMA
5-15P/R .245-.700 18-10 AWG



5356-VA Male
15 Amp Python Industrial Grade.
Nylon, Angle End. Straight blade,
125V, NEMA5-20P, .245-.700
18-10 AWG



P010772SL
6 Outlet Grounded Cord,
120V, 15Amp Circuit Breaker



P010760W
6 Outlet wall mount converter



WD-541388
Trouble Light. 15M, 18/2, double
hook system, 100W max, metal
cage.



P011000 3M (10ft)
P011010 4.5M (15ft)
Shopro Light Duty Block Heater
Cord. With lighted plug in block.
16/3 gauge, 3 outlet



P010802 5M / 16ft
P010803 8M / 25ft
P010804 15M / 50ft
P010805 23M / 75ft
Outdoor extension cord with single
outlet. 16-3 Gauge, SJTW, 13A,
125V, 1625W, 3 conductor



P010812 5m (16ft)
Outdoor extension cord. with single
outlet. 16/3 gauge, SJTW, 13A,
125V, 1625W, 3 conductor



WD-541564 30M (100ft)
Outdoor orange extension cord.
1 outlet/3 cond. 10 amp



WD-545332 3M (10ft)
WD-545340 5M (16ft)
Great for block heaters, battery
blankets, car warmers, etc. Durable
- certified weatherproof, resists UV
rays. Flexible to -40°C



WD-545528 15M (50ft)
Outdoor orange extension cord.
3 outlet/3 cond. 16 gauge, 13 amp

Want to upgrade your building to LED?

Contact AMRE today for an onsite energy audit. Available in most major cities



Save up to 85% on your energy bill by making the switch today!



24-458 Black
24-460 Camo

Multi-Function LED Work Light.

Amazing versatility. Use magnetic base or use hook when steel is not available!· 28 LED Pivoting Work Light· 5 LED Flashlight· Magnetic Base· Pivoting Light· 360 deg Swivel Hook· Batteries Included



111115 Black
111117 Camo

Mini LED Magnetic Flashlight

- 120 Lumens
- 18 LED worklight and 3 LED top flashlight
- Magnetic, folding, and pivoting hook
Includes 3xAAA batteries



MEGAPRO
Every bit better.



6WORKLIGHT

High Intensity LED Worklight.

Compact, pocket-sized and produces a powerful floodlight to let you see your work. Water resistant with a magnetic swivel clip and magnetic base. 3 AAA batteries included.



MEGAPRO
Every bit better.

6VERSA-LITE

MegaPro Versa Lite LED

Folding/Hanging Flashlight.
- 10 White LED's, 250 lumen
- 3 modes, Bright, scattered and spotlight
- Pivoting hanging hook, Magnet back
- 2 xAA included



Energizer

EPMZH21E

Vision HD LED Flashlight

- 300 Lumens
- 115 Meter Beam Distance
- Bright Neutral White LED bulb
- Commercial grade aluminum construction
Includes 2xAA Energizer Max batteries



METAL

Energizer

EPMHH61E

Vision HD LED Flashlight

- 900 Lumens
- 195 Meter Beam Distance
- Bright Neutral White LED bulb
- Commercial grade aluminum construction
Includes 6xAA Energizer Max batteries



METAL

Energizer

1251L

Eveready Industrial LED Flashlight

- Bright LED bulb
- Water resistant and drop tested for reliability
- Resistant to oil and solvents
2xD Batteries required



Energizer

EVFL45SH

Eveready ReadyFlex Floating LED Lantern

- 50 Lumens
- 100 Meter Beam Distance
- Readyflex Technology (2 or 4 D batteries)
- Economical solution for storms, camping, and boating.
Includes 2xD Energizer batteries



Energizer

HCAL41E

Hard Case LED Worklight

- 350 Lumens
- 4 Meter Beam Distance
- Water resistant, 23ft drop resistant
- Retractable hook and strong magnet for different applications.
Includes 4xAA Energizer Max batteries



Energizer

HDDIN32E

Vision HD LED Headlight

- 250 Lumens
- 80 Meter Beam Distance
- Dual-button configuration offers a variety of light modes including red LEDs for night-time illumination
- Silicone beading on strap for added grip
Includes 3xAA Energizer Max batteries



Energizer

TUF2AAPE

Hard Case LED Tasklight

- 250 Lumens
- 105 Metre Beam Distance
- Water resistant, 22ft drop resistant, and shatterproof lens
- Large push button switch can be operated while wearing gloves
Includes 2xAA Energizer Max batteries



111116

LED Clip Strip Pocket Light

- 140 Lumens
- Strip array LED technology
- 180° swivel magnetic clip
Includes 3xAA batteries



111118

Mini LED Pocket Flashlight

- 140 Lumens
- Strip LED in a fist-sized light
- Magnetic swivel clip
Includes 3xAAA batteries



111121

LED Spotlight

- 1200 Lumens
- Includes 2 adjustable joints on magnetic stand for different angles
- 3-level brightness settings with dimmer
4000 mAh Lithium Ion Rechargeable battery



111130

Extending Work Light & Flashlight

- 140 Lumens Front Work Light.
- 120 Lumens Top Flashlight.
4 AAA batteries included.





Energizer Industrial Alkaline Batteries

Part#	Pkg.	Code
EN22	12	9V
EN91	24	AA
EN92	24	AAA
EN93	12	C
EN95	12	D



The longest lasting power source, no mercury added so special disposal is not required, excellent shelf life use even after 10 years of storage (5 on 9V)



1209
Industrial 6V battery.



Energizer Max Alkaline batteries

Part#	Pkg.	Code
E91BP-4	4	AA
E92BP-4	4	AAA
E96BP-2	2	AAAA
E93BP-2	2	C
E95BP-2	2	D
522BP	1	9V



EN91BP-4 EN92BP-4 EN93BP-2 EN95BP-2



522BP

Our # 1 longest-lasting MAX™, hold power for up to 10 years in storage (5 on 9V)



357BPZ
377BPZ
Silver oxide specialty battery. 1.5V for use in watches, calculators, etc.



EL223APBP



EL123APBP



EL2CR5BP

EL123APBP 3V
EL223APBP 6V
EL2CR5BP 6V
Photo battery for optimal performance in cameras. Lithium



#1 longest lasting battery.



L522BP



L91BP-2



L92BP-2

Part # Pkg. Code
L522BP 1 9V
L91BP-2 2 AA
L92BP-2 2 AAA
Energizer Ultimate Lithium Batteries. Long life. Performs in extreme temperatures



ECR1616BP
ECR1620BP
ECR1632BP
ECR2016BP
ECR2025BP
ECR2032BP
ECR2450BP
Lithium specialty batteries, 3V for use in keyless entry, watches, calculators, remotes, medical devices and more



A23BPZ 12V
Specialized battery for keyless remotes, remotes, garage openers etc...



DW-4-4 4/pk
Distilled Water. Commonly used to top off lead acid batteries. 4 x 4L jugs

Sealed Lead-Acid Batteries

Checkout www.amresupply.com for many other in-stock sizes and styles!



Part#	V	Cap Amp	Length Inches	Width Inches	Height Inches	Total Height Inches*	Post Type
6 VOLT							
SLA6-1.2	6	1.2	3.82	0.94	2.05	2.24	T1
SLA6-4.5	6	4.5	2.76	1.85	3.98	4.17	T1
SLA6-5	6	5	2.75	1.84	3.97	4.2	FO-2/3
SLA6-7	6	7.2	5.95	1.34	3.70	3.94	FO-2/3
SLA6-8.5	6	8.5	3.86	2.20	4.65	4.65	FO-2/3
SLA6-12	6	12	5.95	1.97	3.70	3.94	FO-2/3
12 VOLT							
SLA12-1.2	12	1.2	3.82	1.69	2.05	2.28	T1
SLA12-2.3	12	2.3/ 1.30	7.00	1.38	2.40	2.64	T1
SLA12-4	12	4	3.54	2.76	4.17	4.33	T1
SLA12-5	12	5	5.95	2.05	3.70	3.94	FO-2/3
SLA12-7	12	7.2	5.95	2.56	3.70	3.94	FO-2/3
SLA12-10	12	10	5.95	3.86	3.74	4.57	T2
SLA12-12	12	12	5.95	3.86	3.74	3.94	T2
SLA12-20	12	20	7.13	2.95	6.54	6.54	T3
SLA12-28	12	28	6.54	6.89	4.92	4.92	T3/T10
SLA12-32	12	32	7.68	5.12	6.10	7.09	RT-01/FP-07
SLA12-35	12	35	7.75	5.19	6.5	7.49	RT-01/FP-07

* Includes terminals in measurement.



IONIZATION SMOKE ALARMS

Responds first to fast, flaming fires. These type of fires consume combustibles, spread rapidly & generate considerable heat with little smoke

Battery only <small>*Battery could be removed if stressed</small>	BATTERY		LITHIUM		HUSH BUTTON		TEST BUTTON		A		B	
	0916KCA SAFC-318A	9V	N	Y	Y	Y	Y	4.9"	1.5"	4.4"	1.5"	

10Yr Worry Free® <small>No need to replace battery, simply replace unit</small>	SEALED LITHIUM BATTERY		HUSH BUTTON		TEST BUTTON		TAMPER PROOF		A		B	
	0910KCA	Y	Y	Y	Y	Y	Y	5.6"	1.5"			

120V Battery Backup 10Yr Worry Free®	HARDWIRE		VOLTAGE		HUSH BUTTON		TEST BUTTON		TAMPER PROOF		MULTI STATION		BATTERY BACKUP	
	I12010S-CA*	Y	120	Y	Y	Y	Y	24	Y(S)	5.1	1.5			
1276CA	Y	120	Y	Y	Y	Y	24	Y	6"	1.7"				
1275CA	Y	120	Y	Y	Y	Y	24	Y	5"	1.4"				
9120BA	Y	120	Y	Y	Y	Y	18	Y	5.58"	1.97"				

Wireless Battery, Interconnect	BATTERY		VOLTAGE		REMOTE HUSH		TEST BUTTON		TAMPER PROOF		MULTI STATION		A		B	
	900-0201-003	Y	AA	Y	Y	Y	Y	12	5.8"	1.2"						

120V Only	HARDWIRE		VOLTAGE		HUSH BUTTON		TEST BUTTON		L.E.D		MULTI STATION		BUILT-IN RELAY		A		B	
	1235CA	Y	120	Y	Y	Y	N	24	N	5"	1.4"							
9120A	Y	120	Y	Y	Y	Y	18	N	5.58"	1.97"								
ESA5011	Y	120	Y	Y	Y	Y	18	Y	5.25"	1.75"								

PHOTOELECTRIC SMOKE ALARMS

Respond first to slow smoldering fires which produce thick black smoke with little heat before bursting into flames.

Battery only	BATTERY		HUSH BUTTON		TEST BUTTON		A		B		SPECIAL NOTES	
	PE9KCA	9V	Y	Y	Y	4.9"	1.5"					*Battery could be removed if stressed

10Yr Worry Free® <small>No need to replace battery, simply replace unit</small>	BATTERY		HUSH BUTTON		TEST BUTTON		A		B		SPECIAL NOTES	
	P3010K-CA P4010ACLEDSKA	Y(S)	Y	Y	Y	5.22"	1.6"					Note S=Sealed Lithium battery, no need for battery repl., simply replace unit
	Y(S)	Y	Y	Y	5.11"	2.8"						

120V Battery Backup	HARDWIRE		HUSH BUTTON		TEST BUTTON		BATT. BACKUP		A		B		SPECIAL NOTES	
	PPE120CA 7010A	120V	Y	Y	Y	6"	1.5"							*Battery could be removed if stressed.
	120V	Y	Y	Y	5.0"	2.1"								



0916KCA SAFC-318A



0910KCA



I12010S-CA 1276CA 1275CA



900-0201-003



1235CA 9120A ESA5011

ONLY 2" in size!!

First Alert Atom alarm 3V Battery P1000A
 Battery: CR2
 Hush Button: Y
 Test Button: Y
 Size: A 1.9" B 2"
 Fraction of the size with all the protection!

For more details on smoke detectors, visit us www.amresupply.com



Things to know:
 The three types operate on different principles and therefore may respond differently to various conditions.

Ionization models are best suited for rooms that contain highly combustible materials that can create flaming fires. These types of materials include flammable liquids, newspapers, and paint cleaning solutions.

Photoelectric models are best suited for living rooms, bedrooms and kitchens. This is because these rooms often contain large pieces of furniture, such as sofas, chairs, mattresses, counter tops, etc. which will burn slowly and create more smoldering smoke than flames.

Carbon Monoxide models detect an invisible, odourless, poisonous gas that can be fatal when inhaled. It is the #1 cause of unintentional poisoning deaths in North America.

As noted at one manufacturer website, "It's impossible to say one sensor - photo or ion - is universally better at detecting all types of fires."

Why? Because both sensors are designed to respond to combustion particles produced by smoldering or flaming fires, and because fires themselves are different.



PE9KCA



P3010K-CA P4010ACLEDSKA



PPE120CA 7010A

Call us for a quote on large projects and take advantage of substantial bulk buy savings on alarms!



CO DETECTORS/ ALARMS

**120V & 9V
Battery Backup**
**Battery can be removed if stressed*

	HARDWIRE	PLUG-IN	BATTERY	VOLTAGE	BATTERY BACKUP	WIDTH/DEPTH	HEIGHT/DIAMETER	
900-0235	N	Y	N	120V	Y	3"	6.8"	Note S=Sealed Lithium battery, no need for battery replacement, simply replace unit) 10Yr Warranty Free* *Interconnect with upto 24 Kidde devices
900-0076-05	N	Y	N	120V	Y	3.7"	6.1"	
900-0263CO-CA	N	Y	N	120V	Y	2.8"	4.7"	
900-0233	N	N	Y	3xAA	N	3"	2.2"	
CO5120BNA	Y	N	N	120V	Y	1.83"	5.4"	
C3010-CA*	N	N	Y	S	N	4.6"	3"	
900-0128-001*	Y	N	N	120V	Y	5.75"	1.8"	



COMBINATION SMOKE & CO DETECTORS/ ALARMS

**Voice messages
w/warnings**

	HARDWIRE	VOLTAGE	BATTERY	HUSH BUTTON	TEST BUTTON	BATTERY BACKUP	A	B	
CO/Ionization									
900-0220*	N	2xAA	Y	Y	Y	N	4.8"	1.3"	* w/Voice message warning
900-0119*	Y	120V	N	Y	Y	Y	4.8"	1.3"	
SC9120A	Y	120V	N	Y	Y	N	5.58"	1.97"	
SC9120BA	Y	120V	N	Y	Y	Y	5.58"	1.97"	
CO/Photoelectric									
900-0213*	Y	120V	N	Y	Y	Y	6"	1.9"	



COMBO SMOKE & CO DETECTORS/ALARMS 10yr

10 Yr Warranty Free

10yr Warranty Free, no need to replace battery, simply replace unit

	SEALED LITHIUM BATTERY	HARDWIRE	HUSH BUTTON	TEST BUTTON	TAMPERPROOF	A	B	
CO/Photoelectric								
P3010L-CO-CA	Y	N	Y	Y	Y	5.22"	1.4"	* 120V w/ battery backup
CO/Ionization								
I12010S-CO-CA*	Y(BUP)	Y	Y	Y	Y	5.5"	1.5"	
P4010ACLEDSCOCA	Y(BUP)	Y	Y	Y	Y	5.11"	2.8"	



MULTI GAS DETECTORS/ ALARMS

**Digital readout,
peak level
memory**

	DIGITAL CO	PROPANE	NATURAL GAS	VOLTAGE	BATT. BACKUP	PLUG-IN	TEST BUTTON	W X HEIGHT
900-0113-05	Y	Y	Y	120	Y	Y	Y	3.7" x 6.1"



SPECIALTY DETECTORS/ ALARMS

Strobe Alarm

remote visual signalling device

	HARDWIRE	VOLTAGE	MULTI-STATION	HUSH BUTTON	TEST BUTTON	A	B
SLED177I	Y	120	24	N	N	5.6"	3"

If using different brand detectors order SL177 and SM120X relay.



SM120X

Relay module

Activates or deactivates auxiliary devices such as bells, lights and ventilation systems. For use with all interconnected installations that contain smoke alarms and smoke / CO combo units and heat detectors.



Testers! Test Your Smoke Detectors Regularly

CFSMOKE
Smoke detector tester,
60 x 30 second tests



72105
Smoke Detector
Tester (177mL)



Introducing a totally new concept
in smoke detector testing!



SABRE 150ml
Extending smoke detector tester.
Just a flick of the wrist.

- More tests per can
- Faster detector activation and clearing
- No residue, silicone free





K4000 Series Fixed Position Photo Control

K4021 1800W

Thermal-type photo control that fits into a standard outlet box, post lamp, or wall pack. The photo controls provide dusk-to-dawn lighting control along with a delay action, which eliminates loads switching OFF due to car headlights and lightning. 3/8"-18 NPSM, 3/4" long stem with locking nut and washer gasket
1000W Ballast / 15 Amp Tungsten / 8.3 Amp Ballast / 120V



K4200 Series Stem and Swivel Mount Photo Control

Other voltages available

K4221C 1800W

Stem and swivel mounting, with thermal-type controls. The photo controls provide dusk-to-dawn lighting control along with a delay action, which eliminates loads switching OFF due to car headlights and lightning. Swivel with 1/2"-14 NPSM threaded stem.
1000W Ballast / 15 Amp Tungsten / 8.3 Amp Ballast / 120V



K4100 Series Stem Mount Photo Control

Other voltages available

K4121C 1800W

Stem mounting, thermal-type control. The photo controls provide dusk-to-dawn lighting control along with a delay action, which eliminates loads switching OFF due to car headlights and lightning. 1/2"-14 NPSM threaded stem. 1000W Ballast / 15 Amp Tungsten / 8.3 Amp Ballast / 120V



Decorator Spring Wound Timers

Designed to replace any standard or decorator style wall switch, single- or multi-gang. Mechanical timers do not require electricity to operate. They automatically limit the ON times for fans, lighting, motors, heaters and other energy consuming loads.

SPST, 7 Amp Tungsten, 125VAC

Time Cycle	Ivory With Hold	White With Hold
15 minute	FD15MC	FD15MWC
30 minute	FD30MC	FD30MW70
60 minute	FD60MC	FD60MWC



156T1978A

Time Clock Trippers, On/Off, use with T100, T100-20, T7400B, T7800B, WH10, 30, 40



146MT494A

White

146MT573

Almond

Intermatic Time Switch Replacement Knobs
Used on FD Series Timers



24 Hour Electronic (28 set points)

An easy way to upgrade from a basic mechanical time switch to an electronic time switch. Allows up-to-the-minute programming, battery backup for power loss, up to 28 events total, and automatic daylight saving time corrections without the need of user interaction.

Schedule a different operation everyday!

Single pole, single throw

ET8015C 120-277V

Two circuit SPST or One circuit DPST

ET8215C 120-277V



**Astronomical Series allows dusk/dawn settings without photocell.*



24 Hour Dial

Dependable time switches can handle electrical loads up to 40 A per pole and allow for up to 12 ON/OFF operations per day. A manual override switch provides added convenience. Designed for industrial, commercial and residential applications.

Single pole, single throw

T101-70 125V, 2 HP

T102-70 208-277V, 5 HP

Double pole, single throw

T103-70 125V, 2 HP



LTB15-1LZ

Decora Preset 15 Minute Countdown Timer - 120VAC, 60Hz, 1800W Incandescent, 20A Resistive/Inductive, 1HP, single pole 3-way or more locations, four preset buttons for 2-5-10-15 minutes, neutral required. White assembled on device, ivory and light almond included.

Locations Across Canada

Stop in one of our Amre store locations to see our great selection of products.

24 HR. 
Order by **4pm** for **24-48hr shipping**
to almost anywhere in Canada!

www.amresupply.com
1.800.661.9891



More Power Than Family Radios



UP TO 32KM

T200

Motorola 2-Way Radio. 32km range, 22 channels, dual power, keypad lock, accessory jack and much more. Compatible with any radio. Incl: 2 radios, 1 wall charger with Y cable & 2 NiMH battery packs, 2 belt clips.

30 Floor/350,000sqft Coverage!
LED Interface!



RDU4163D

Motorola Onsite Business Radio
* Up to 4 watts of power, 2 out of box
* 2UHF frequencies w/39 analog/83digital codes
* Up to 16 channels
* Preprogrammed channels
* 18.5 hours battery life w/battery save
* Advanced voice activation
* 3 Audible call tones
* Includes battery, drop-in charger and spring belt clip

30 Floor/350,000sqft Coverage!



RDU4103

Motorola Onsite Business Radio
* Up to 4 watts of power, 2 out of box
* 2UHF frequencies w/39 analog/83digital codes
* Up to 10 channels
* Preprogrammed channels
* 18.5 hours battery life w/battery save
* Advanced voice activation
* 3 Audible call tones
* Includes battery, drop-in charger and spring belt clip

"Drop-In Charger Now Included!"

UP TO 8KM



CLS1413

Motorola 2-Way Business Radio. 8km 200 000sqft or 15 floors range, 4 channels, LCD display and many more features. Incl: Lithium ion battery, charger and swivel holster

20 Floor/250,000sqft Coverage!



RMU2043

Motorola Two-Way Business Radio
* 1-4 channels
* up to 250,000 sq ft/20floor coverage
* 2 Watt UHF frequencies
* 219 PL/DPL codes
* Channel announcement with voice alias
* Up to 15 hours battery life w/battery save mode
* Includes battery, drop in charger, swivel belt holder



IS-401B 4-Wire

IS-400B 5-Wire

Low profile 3 button intercom. 3.5" speaker. 45Ohm, IB-10A plaster ring or IB-2A Backbox sold separate. 8-1/16"x5-5/16". IS-401B uses MA-485A amp, IS-400B uses MA-210 amp. Used most commonly with G series or M3000 lobby panel.

24 HR. 
Order by 4pm for 24-48hr shipping to almost anywhere in Canada!



1150 Call Tone

IS-92BZ Buzzer

Handset comes with buzzer and release button mounts on standard electrical box. Lift the handset to communicate then press a button to permit entry. See website for specs.



SW-065 White

MIRCOM Intercom Push-Button



BK120NBWH

Door bell chime kit. Dimensions: 5" x 9" x 2". * Two unlighted buttons, chime and transformer.

Plug-in



SL-6151-C

Wireless Plug-in door chime kit. White, Up to 75ft, 2 note, c/w 1 push button

Battery



SL-6150-C

Wireless Battery operated door chime kit. White, Up to 100ft, c/w 1 push button



SL-6144-A

Wireless Plug-In door chime kit with strobe light. For hearing impaired or noisy environments. White, Up to 75ft, c/w 1 push button

New!

Works with existing wiring!



DCAM100

Nutone Knock Smart Video Door bell Camera. Motion-sensing camera works day or night, speak to anyone who rings the doorbell or convenient do-not disturb feature.



667-1

Black

715W-1-C

White

Door bell pushbutton only, unlighted, for wired door chimes



PB-01L White

AirKing lighted doorbell push button for wired door chimes



SL-6197-B

Wireless Push button only. Off-White, Up to 150ft, Surface mount. Use with wireless chimes



Urinals



6590001.020
Washbrook™ flowise® universal urinal. Ultra High Efficiency, Low Consumption 0.10 to 0.8gpf (0.5 to 3.8Lpf). Flushing rim, 3/4" inlet spud, outlet 2" (NPTF) 2 Wall hangers and meets ANSI. Universal top spud



6550001.020 White Allbrook Flowise Urinal. Ultra High Efficiency (1.9-3.8 lpf), Flushing rim, Siphon jet flush action, 3/4" inlet spud, Outlet connection threaded 2" inside (NPTF), Wall hanger, Meets ANSI requirements



6042001EC.020 White Decorum Urinal (0.125gpf (0.47Lpf) High Efficiency. Sleek, modern, compact vitreous china design. Deep sump reduces splashing. EverClean surface, 3/4" inlet spud. Wall hangers included



6002001.020 White AmStd Pintbrook Urinal. Ultra high efficiency (0.47 Lpf/1.9 Lpf) powerful washdown, superior splash protection, 3/4" top spud, outlet 2" NPT, hangers included.

Toilets - Commercial



H.E.T.



Madera FloWise
3451001.020 15" Rim Height
3461001.020 16.5" Rim Height (ADA)
Elongated floor mount flushometer valve toilet, 1-1/2" top spud
- High Efficiency 0.9 to 1.6gpf (4.2 to 6.0Lpf)
- EverClean Surface.
- Fully glazed 2-1/8 trapway
- 10" or 12" rough-in
- Condensation channel
- Powerful direct-fed siphon jet action
- 10" x 12" water surface area



H.E.T.



Afwal Millennium FloWise
3351101.020
American Standard Elongated wall-mounted toilet, 1-1/2" top spud, HET when used with HE flush valve
- High Efficiency 0.9gpf to 1.3gpf (4.2lpf to 6.0lpf)
- Condensation channel
- Powerful direct-fed siphon jet action
- Fully glazed 2-1/8" trapway
- 10"x12" water surface area
- Seat sold separate
- 26" x 15" x 14"
- 1000g MAP



Unique 3-Bolt Re-launched!



Rapidway 3 Bolt
3445J101.020 Top Spud
American Standard elongated wall mount toilet, unique 3 bolt design
- 1-1/2" spud, 10"x12" water surface
- Low consumption 1.6gpf/6.0Lpf
- 2-1/2" Trapway, condensation channel
- 25" x 14" x 15-1/2" Elongated Bowl
- Seat sold separate



034638-0070A
AmStd Conical Sponge Urinal Washer. 2" diameter.



047068-0070A
AmStd Urinal Strainer. Stainless Steel. For Washbrook urinal.



ULN220 2" x 2"
ULN220A 2" x 1-1/2"
ULN220C 1-1/4" x 1-1/4"
ULN220BC 1-1/2" x 1-1/2"
ULN220D 1" x 3/4"
Water Closet and Urinal Spuds
Complete Brass
ULN231 2" x 2"
ULN231A 2" X 1-1/2"
ULN231B 1-1/2" x 1-1/2"
ULN231C 1-1/4" x 1-1/4"
ULN231D 3/4" X 1"
Spud Gaskets only



WES-150
Sloan/Falcon Waterfree Urinal Cartridge Kit.
Lasts approx 7000 uses. Includes 1 each Cartridge, Key, Sealant Package, Glove and Disposal Bag



7501-006
Harveys No.6 Urinal Wax Ring. Fits 2" Outlet.



31187
Urinal wax ring, urethane sponge to provide resiliency. Fits 2"



FUS-2
Wax Free Urinal Seal. Fast, easy installation, long term solution - even reusable on the same urinal during service. Strong, flexible adhesive creates a positive seal with the urinal, fits 2" drain

Trust Amre for all of your commercial washroom solutions!

- Quotes Available on All Brands
- Waterless Urinals & Water Saving Solutions
- Fixtures & Repair Parts



Call us for ANY model . ANY brand . Check out our website www.amresupply.com for more specs and models!

American Standard



Best Sellers

Colony

- 12" rough-in
- 2" flush valve & 2" trapway
- PowerWash rim scrubs bowl w/each flush
- Seat not included
- Also available in Bone

Bowl:

- 3251D101.020** Round
- 3251C101.020** Elongated
- 3251A101.020** Elongated RH

Tank:

- 4192A004.020** 6L/Unlined
- 4192A104.020** 4.8L/Unlined
- 4192A154.020** 4.8L/Lined

American Standard



Vormax Flush system!
Perfect for hospitality

VorMax flushing technology cleans 2X better

- 12" rough-in
- EverClean® Antimicrobial Surface
- CleanCurve™ rim eliminates area where dirt hides
- 2-1/16" trapway
- Dual injection flush valves
- *Seat sold separate*

Bowl

- 3870A101.020**
- Elong. Right Ht. 16.5"

Tank

- 4270A104.020**
- Unlined - 4.8L

American Standard



Cadet Pressure Assisted

- Pressure assisted siphon-jet flush
- 12" rough-in
- Fully glazed 2-1/8" trapway
- ADA approved
- Sanitary bar on bowl
- 10"x12" water surface
- Seat not included
- Also available in locking lid

Bowl:

- 3481001.020** Elong. REG. 15"H
- 3483001.020** Elong. RH 16.5"

Tank:

- 4142100.020** 4.2L
- 4142016.020** 6L

American Standard



Evolution 2

- 12" rough in
- Fully glazed 2" trapway
- 2" flapper flush valve
- Seat not included
- Siphon action bowl with direct fed jet and excellent rim wash
- 9" x 8" water surface area
- Sanitary bar on bowl

Bowl:

- 3061001.020** Round
- 3068001.020** Elong. Right Ht.

Tank:

- 4061016.020** Unlined - 6L
- 4061128.020** Unlined - 4.8L

PRO Advantage

American Standard

Pro Series Advantages

- Exclusive to trade industry
- EZ Install tools included
- Metal trip lever and metal fill valve shank
- Not available in box stores



Champion 4 Pro

- 12" rough in
- Fully glazed 2-3/8" trapway
- Low consumption 1.28gpf/4.8Lpf
- 4" piston action Accelerator™ flush valve
- seat not included
- PowerWash Rim scrubs bowl
- EverClean Surface
- 1000g MaP Score

Bowl:

- 3195B101.020** Round Right Ht.
- 3195A101.020** Elongated Right Ht.

Tank:

- 4225A104.020** Unlined - 4.8L
- 4225A154.020** Lined - 4.8L



Cadet Pro 6L and 4.8L Flowise

- Fully glazed 2-1/8" trapway
- 9" x 8" water surface area
- 3" flush valve w/chemical resist. flapper
- seat not included
- PowerWash Rim scrubs bowl
- EverClean Surface
- 1000g MaP Score

Bowl:

- 3517D101.020** Round
- 3517B101.020** Round Front Right Ht.
- 3517C101.020** Elongated
- 3517A101.020** Elongated Right Ht.

Tank 12" Rough-In:

- 4188A004.020** Unlined - 6L
- 4188A104.020** Unlined - 4.8L
- 4188A054.020** Lined - 6L
- 4188A154.020** Lined - 4.8L

Tank 10" Rough-In

- 4188B004.020** Unlined - 6L
- 4188B104.020** Unlined - 4.8L



Check out the **new ActiClean® toilet** by:

American Standard

A Self-cleaning toilet that cleans and removes stains with a simple press of a button!
#714AA154.020 at AmreSupply.com



Residential Plastic Seats



70	Part#	Colour	Price
Regular Round Front - Closed Front W/Cover - Standard Weight - Top-Tite® Hinge	70-000	White	
	70-006	Bone	
800EC - Easy Clean	Part#	Colour	Price
Regular Round Front - Closed Front W/Cover - Residential Weight - Top-Tite® Hinge	800EC-000	White	
	800EC-006	Bone	
200TC	Part#	Colour	Price
Regular Round Front - Closed Front W/Cover - Residential Weight - Top-Tite® Hinge	200TC-000	White	
1800 - Easy Clean	Part#	Colour	Price
Elongated - Closed Front W/Cover - Residential Weight - Top-Tite® Hinge	1800EC-000	White	
	1800EC-006	Bone	

Better

Best

Better

Slow Close Hinge Seat



Whisper•Close®

Slowly and quietly closes with a tap, eliminating slamming and pinched fingers. EasyClean & Change. Seat removes easy for cleaning and replacement

Resilient plastic, solid molded-in color resists chips, wear and stains.

	Part#	Price
Round - Plastic Seat - Easy-2-Clean - Lift-Off - Slow Close Hinge Seat - Heavy Weight	730SLEC-000	White
Elongated - Plastic Seat - Easy-2-Clean - Lift-Off - Slow Close Hinge Seat - Heavy Weight	730SLEC-000	White



	Part#	Price
Round - Bemis iLumaLight™ - Easy•Clean & Change® - Whisper•Close®	200E3NL	White Round
	1200E3NL	White Elongated

iLumaLight™ - 8-hour night light provides the perfect amount of illumination.
Precision Seat Fit™ - 1/2" front to back adjustability provides the perfect bowl fit
STA-TITE® Seat Fastening System™ - Never loosens™
Super Grip Bumpers™ - Prevents the seat from shifting on the toilet bowl, providing greater stability

Residential Molded Wood Seats



500PRO - Easy Clean	Part#	Colour	Price
Regular Round Front - Closed Front W/Cover - Top-Tightening Ultrahinge™	500EC-000	White	
1500PRO Easy Clean	Part#	Colour	Price
Elongated - Closed Front W/Cover - Top-Tightening Ultrahinge™	1500EC-000	White	

Commercial Plastic Seats



1955C	Part#	Colour	Price
- Open Front Less Cover - Heavy Weight - Stainless Steel Com. Sta-tite fastening sys.	Elongated 1955C-000	White	
	1955CT-047	Black	
		Rounded Front 955CT-000	White
1950	Part#	Colour	Price
- Open Front With Cover - Heavy Weight - Non-Corrosive Hex-Tite™ Bolts and Wing Nuts - *300 Series stainless steel hardware	Elongated 1950-000	White	
	1950SS-000	White*	
		Rounded Front 950-000	White
1240 - Eljer	Part#	Colour	Price
- Fits Eljer Emblem bowls - Top-Tite® Hinges - Non-Corrosive Bolts and Wing Nuts	Elongated 1240205	White	
		Rounded Front 124-0200-000	White

Built-in Potty Seat™



Great for daycares, schools and home!

Built-in Potty Seat™ Secures magnetically into cover when not in use to reduce clutter. Child seat removes when no longer needed or for easy cleaning.

Accommodates both adult and child users.

	Part#	Price
Round WhisperClose slow close design Sta-tite fastening EasyClean & Change hinges for easy cleaning and changing.	483SLOW-000	White
	Part#	Price
Elongated WhisperClose slow close design Sta-tite fastening EasyClean & Change hinges for easy cleaning and changing.	1483SLOW-000	White





42443

SetFast Self Adjusting Closet Bolts.
 - No cutting
 - Solid brass/S.S.
 - Slotted design for no spinning
 - 5/16" x 2-1/4"
 - Adjust. no-tip nylon lock washer
 May not be suitable for raised or repaired flanges



ULN206
 5/16" X 2 1/4" Solid Brass Closet Coupled Bolts C/W Nuts, Washers (Pair)

Extra Length



ULN206L
 5/16" x 3" extra length solid brass closet bolts, c/w nuts & washers (Pair)



84 5/16" x 2-1/4" Closet Plastic Bolt, Molded Pyramid Shaped Base and "Ears" Lock Bolt Into Flange Tracks. Sold in Pairs



ULN205
 5/16" x 2-1/4" closet screws, solid brass, c/w nuts & washers (pair)



ULN258
 White, American Standard Snap-on Plastic Bolt Cap Cover C/W Flange

No more lost bolt caps



ULN258S 2/pk
 Deluxe thread on toilet floor bolt caps. Includes inserts to fit different bolt sizes.



ULN259S
 Toilet shims 4/pk



300J Hard Clear
7300J Soft White
 Toilet shim (wedge). Hard or soft available.



1012
 Toilet Cover Plate (Shoe). White plastic, Saves removing damaged flooring. Caulk & seal design. 13" x 23-1/2"



603019 Flush
602250 Adj. ABS toilet floor flange. 4" x 3"



602292
 Off-set 4" x 3" ABS toilet flange



21013
 Quick Ring, Unique Screw Hole Tabs Allow the Quick Ring To be Attached to Wood or Concrete Sub Floors



1018K
 Toilet Bowl extension kit, Includes 3 self sealing rings, 1/4" x 3-1/2" closet bolts, nut and washers.

Oatey



43651 4"
43654 3"
 PVC Twist-N-Set closet flange. Replaces broken cast iron closet flanges, installs without tools and no need to tear up existing floor.

Oatey



43650 4"
43655 3"
 Installs easily without tools No need to tear up the existing floor Gasket expands to fit service weight., heavy weight and no hub soil pipe



386-080 Light
386-140 Heavy
 4" Brass toilet floor flange, 4 hole



ULN288
 ABS toilet floor flange



SF-100
 Fix-a-flange. repairs broken toilet flange, simply place under broken area and tighten nut.



Perfect for use while changing toilets!



31418
 Solidifies water for easy toilet removal Prevents Water Spills Gel formed in 4 minutes Non-toxic, Lo-V.O.C.



FTS-3 3"
FTS-4 4"
 Fernco's Wax-Free Toilet Flange. Fits inside of plastic, copper or cast iron drain pipe.



001035
 No Seep No.1 Standard Wax, fits 3" & 4" lines, with horn

Oatey



31188
 Max-Wax seal with horn, fits 3" to 4" waste lines 40% thicker wax ring with a polyethylene sleeve to assure a tight seal



007070
 Bol-Wax No.1 Standard 8 oz., no horn

ZURN



Z-1210-57
 Zurn Neo-Seal closet gasket kit. Closed-cell Neoprene resistance to water, petroleum products, similar chemicals, excellent resiliency to rotting. Dual sided peel and stick adhesive backing for clean and efficient installation.



3270-001 12"
 Toilet Installation Kit. Includes 12" stainless steel supply line, wax gasket with flange and closet bolts





C7715-5
Water Matrix Toilet Tank Bolt Assembly Kit. c/w 2 bolts - 5/16", 2 rubber washers, 2 brass washers, and 2 nuts. For use with N7715 tanks.



C7715-4
Water Matrix Proficiency Toilet Tank To Bowl Gasket. For use with N7715 tank



ULN209
5/16" X 3" Tank To Bowl Kit
Includes: 2 Solid Brass Bolts, 2 Solid Brass Nuts, 4 Solid Brass Washers, 4 Laminated Washers & 1 Sponge Gasket MP19



ULN209A
5/16" X 3" Tank To Bowl Kit With Extra Heavy Crane Type Sponge Gasket MP20



For 4" American Standard



738756-0070A
American Standard Toilet Tank Gasket and Bolt Kit. For 2pc 4" Champion models.



2116
5/16" X 3" Solid Brass Closet Coupled Tank Bolts 2/pk. Larger diameter washers



ULN209BF W/Wing Nuts
5/16" x 3" Solid Brass toilet tank bolts c/w additional wing nuts, 2/pk



ULN234
Extra Heavy Tank To Bowl Gasket G605Z

For 3" toilets



ULN234A
3" Sponge rubber toilet tank to bowl gasket, fits Am.Std and many other 3" flush valves.



ULN226 1/2" X 4"
ULN227 3/4" X 4"
Sponge Rubber Closet Gaskets



ULN233
Sponge Rubber Tank To Bowl Gasket #11

New!



9BU062E
Toto Aquila Tank to Bowl Gasket.



ULN209KH (GP51487)
Kohler Tank to Bowl Gasket kit



C2216-28
Niagara Toilet Tank to Bowl Gasket.



AMRE SUPPLY

Property Performance Centres

Parts Distributor for most major brands of toilets

Any Brand . Any Model . Any Job

Call us with your toilet model# today!



www.amresupply.com

more **Parts** . more **Supplies** . more **Products**

Plumbing



American Standard
For 3" Cadet Pro Toilets



7381193-200.0070A
 American Standard 3" flapper. Fits most Cadet Pro models. (540A)

American Standard
For 3" toilets



738920-0070A
 American Standard 3" Flapper White, 1.6 GPF. Chemical Resistant Flapper. For Tank 4021, 4019, 4021.500 and 4027

Long Life PREMIUM
American Standard



ULN214AL
 Long Life rubber snap on seat disc for American Standard No.5 flush valve, Non OEM, 1/pk.

Fluidmaster
American Standard



5103
 American Standard seat Disc, Fits All American Standard -. Actuator Flush Valves, Snap on or thread. type actuators, & chlorine-resistant material

American Standard



ULN214G (O.E.M.)
 American Standard Snap-On Disc Premium quality

American Standard



ULN230AS (7301111-0070A)
 American Standard Champion 4 flapper seal. Non O.E.M, 4"

Long Life PREMIUM

CRANE PLUMBING



ULN213L
 Hornet Long Life vinyl/rubber flapper with chain and hook.. New Style Crane, Non OEM, 1/pk

CRANE PLUMBING



ULN213
 Crane New Style, Crane Replacement Flapper with Chain and. Hook Fits ULN218

10090
 Coast Blue toilet flapper, universal with rubber strap



Long Life PREMIUM

COAST PRODUCTS



ULN213A (53206)
 Coast Blue Vinyl, chlorine resistant, Crane Replacement Flapper with Chain and. Hook Fits ULN218

Eljer



11345
 Eljer white plastic stainless steel chain Fits ELJER - LOW BOY, WINDSOR, CANTERBURY Styrofoam ball

Eljer



ULN212EL (495-6036-00)
 Eljer flapper and chain with counter balance for insulated tanks

korky



10156LC
 Korky/Kohler 2" Hinge Style Toilet Flapper. Fits some 1pc models. Premium Chlorazone rubber. Fits OEM 84995 & 1000490

korky



10155LC
 Korky/Kohler one-piece toilets Premium red Chlorazone rubber resists chlorine Embedded styrofoam float Replaces KOHLER #83064

THE BOLD LOOK OF KOHLER



GP87449
 Kohler 2 Piece Toilets, 2" Flushvalves

THE BOLD LOOK OF KOHLER



GP1059291
 Kohler Toilet Flush Valve Seal. For all class 5 and 6 canister flush style toilets. 3-1/2"D

THE BOLD LOOK OF KOHLER



GP85160
 Kohler 2 Piece Toilets, 2" Flushvalves

THE BOLD LOOK OF KOHLER



GP1078440
 Kohler 1 Piece Toilets, 2" Flushvalves



THE BOLD LOOK OF KOHLER
For 3" toilets



ULN213KH (GP1078441)
Kohler Class 5 flapper, 3-1/4"

Hornet For 3" toilets



ULN213HL
3" Long Life Vinyl Hornet™ Flapper, Long life vinyl 3" flapper with chain and hook. Fits American Standard, Toto, Jacuzzi, and most 3" flush valves

Long Life PREMIUM



ULN214L
Long Life vinyl Hornet universal flapper with chain

Fluidmaster
5 min. repair kit



555CC
Fluidmaster Flush Valve Repair Kit. 5 minute install, no tank removal. Fits on existing valve seat. Adjustable

TOTO

Improved design

Toto Universal 3" Flapper THU499S

Includes instructions for settings and install per Toto model to insure perfect flush. Adjustable chain and arrow for volume/closing speed.

Replaces THU138S, THU175S, THU331S, THU140S, THU299S, THU253S, THU277S, THU347S, THU275S, THU332S and THU369S



TOTO



THU257
Toto OEM 2" Toilet Flapper

Long Life PREMIUM

Korky



55K
Korky universal flapper, premium red chlorazone rubber resists chlorine



ULN214E
Fits All Replacement Flapper With Rubber Strap (Fits Most Flush Valves)



ULN214
Fits All Replacement Flapper with chain (Fits Most Flush Valves)

Fluidmaster For 3" toilets



5403
3" Universal flapper restores the original performance of all major brands and models, including Toto, Kohler, Eljer, American Standard, Gerber, and Mansfield.

Fluidmaster



500C
Replaces old tank ball or worn flapper. Easy to install, fits most tanks.

Fluidmaster



501C
Fluidmaster, Bullseye Super Flapper. Thermoplastic flapper, won't rot, Outlast Vinyl or Rubber, Attached to a rigid frame for better alignment

Fluidmaster



502C
Fluidmaster Universal PerformMAX High Performance Toilet Flapper. Adjustable for max performance and water savings. best for 1.28-3.5gpf toilets

Fluidmaster



503C
Fluidmaster Universal Toilet Flapper. Works on most toilets with or without mounting ears

Fluidmaster



504C
Fluidmaster universal long life toilet flapper with chain and hook

New!



7381129-200.0070A
American Standard 2" Flapper



1022
Frugal flush toilet flapper, with chain and hook.

mansfield



ULN230A
Mansfield 211 Flush Valve Seal

Western POTTERY, L.L.C.



FLAPPER-2
Western Pottery Toilet Flapper. 2.5" (2-1/2")

Western POTTERY, L.L.C.

For 3" toilets



FLAPPER-3
Western Pottery Toilet Flapper, 3"

New!



5100
Fluidmaster Universal Tank Ball Flapper. With brass rod.

WATER MATRIX



C7715-1
Water Matrix Proficiency BSB Kit. Older style.

WATER MATRIX



C7715-3
Water Matrix Proficiency Air Tube, works with older style BSB Kit only.



Flush Valves

American Standard



ULN218A Tall American Standard Short Flush. Valve Assembly C/W Actuator. (QH-3161/QH-3165)

American Standard



ULN214B (QR-9350) #5 American Std. Flush Valve Actuator Assembly Only. With premium flapper disc

American Standard



3174.002-0070A American standard champion flush valve assy, 4"

American Standard



3280.040-0070A American Standard 4" flush valve for 1pc Champion 4 and Porcher 1 pc toilets

American Standard

For 3" toilets



ULN218PL (738921-101.0070A) American Standard 3" Flush Valve Assembly. Fits Cadet 3 & Jacuzzi Perfecta models.

Mansfield



ULN218D
OEM 210 (13L)
ULN218E
OEM 211 (6L)
Mansfield Flush Valve

Mansfield



2255907
Mansfield Flush Valve Stop

Fluidmaster



507AK
Fluidmaster Universal Complete Flush Valve Kit. For 2" flush valves. Includes flush valve, gasket, locknuts, brass bolts, ss washers/nuts, and rubber washers

Fluidmaster



507A
Fluidmaster Universal Toilet Flush Valve. Fits 3.5gpf toilets



ULN218
Plastic Flush Valve w/Flapper Unit (CSA) 3903

The Niagara Flapper System



C4416-2 4.8L
C2216-2 6.0L
Niagara Dump Bucket

TOTO



THU224
Toto Aquia Dual Flush Valve Assembly

Vortens



V221
Vortens Toilet Dual Flush Valve Assembly. Fits Rhodas ADA DF, Vienna EL DF, Vienna RF DF 3436 & 3437

WATER MATRIX



C7715-6
Water Matrix Proficiency Flush Valve. Old style.

WATER MATRIX



C7715-10
Water Matrix Proficiency Flush Valve. Newer style. N7

Western POTTERY



FV-REG
Western Pottery Toilet Flush Valve. Fits models T8, T5, LP, HP Tanks



Ballcocks (fill valves)



ULN228MT 11.5" (88)
Mansfield Plastic, anti-siphon
Adjustable water lever Unified
construction. Includes 8" float rod,
8" refill tube, acetal locknut and
coupling nut



C2216-9
Niagara fill valve kit, fits model
2216, 6L



C2216-RK2
Niagara copper supply kit



528C
Korky QuietFill Fill Valve.
Extremely quiet, fits all brands,
easy to install and adjust, no tools
required



**Pro Grade
Most
Universal
Fill Valve!**



528PRO
Korky Pro Grade fill valve. Adjust-
able refill delivers the right amount
of water to the bowl to provide
OEM performance. Fits Kohler,
Toto, AmStd etc. 1.28/1.6/3.5GPF,
quiet & Pro construction



400A
FluidMaster Adjustable Ballcock
Assembly Complete, Anti-Siphon



PRO45 Standard
PRO45B Brass Shank
Fluidmaster Pro Series fill valve. Ul-
tra quiet operation is the quietest on
the market and minimalizes water
hammer



400ARHR
Fluidmaster
PerforMAX®
High Performance
Toilet Tank Fill Valve. Most quiet
and powerful on the market. 2X
greater refill rate. Perfect for any
toilet including HET models



400LSCPRO 10" to 14"
Prevents damage from broken
tanks. Leak Sentry Pro Ballcock
stops noise & dripping, won't over-
fill toilet bowl



**Complete
Tank Repair
Kit!**



400AK
Fits most 2 and 3-bolt tanks. In-
cludes 400A fill valve, chrome tank
lever (universal) 3 bolts + tank
gasket, dial-a-flapper flush valve.



400CC
Features the proven 400A Fill
Valve and the rugged Bull's Eye®
Super Flapper (501). Flapper is
chlorine-resistant for harsh water
regions



M5350
Moen M-Line Universal Toilet Fill
Valve. Handles inflow water of
any speed and pressure.



ULN228E
Hush Flo Short Ballcock with
Adjusting Screw-Saves Water.



**Completely
Universal**



TSU99A
Toto Universal Fill Valve Assem-
bly. Adjustable style, for use with
all TOTO toilets.



RV-10 T8, T8-HP, T8-HET
RV-12 T5, T8-LP
Western Pottery Toilet Fill Valve.



A60
Anti-Syphon 9"-13" adjustable
ballcock float not included



Ballcock Repair



ULN237
Hoover Ballcock repair kit



ULN239
Coast ballcock repair kit



ULN244
Complete Repair Kit For. American Standard Plastic. Ballcock QR9506

Fluidmaster



242C
Diaphragm For Fluidmaster Ballcock 504



THU123
Toto Lavelle Fill Valve Cap With Diaphragm



ULN229T
Hoover 4 screw toilet ballcock top assembly



ULN222
4" X 5" Poly Tank Float P83



ULN265
9" Brass float rod

Handles

American Standard



1082W White
1082 Chrome
American Standard replacement plastic tank lever, fits 4"-6". QH3987, Unique 45degree angle. White

American Standard



ULN201BK White
ULN201AK Chrome
ULN201CK Bone
4-1/2" Plastic, Short Lever common for American Standard

American Standard



ULN201T OEM
1063W Non OEM
6" Plastic, long lever for American Standard, 45 degree angle



ULN201A Short 5-1/2"
ULN201 Long 8"
Galtmaster C.P. Deluxe Tank Lever, metal

Mansfield



ULN201MC 10-1/2"
Mansfield #41 toilet tank lever, chrome

Mansfield



ULN200MW White
1045 Chrome
Mansfield tank lever, 9"

NIAGARA



N2201 Chrome
Niagara handle repair kit



Order by **4pm** for **24-48hr** shipping to almost anywhere in Canada!

Fluidmaster

680C White
681C Chrome
Sure-Fit Toilet Tank Flush Lever, Trims/Bends to fit most front, side and angle mount tanks. Self tightening lock-nut won't loosen over time. 4" - 8"



ULN200W White
ULN200CP Chrome
ULN200FK Bone
8-1/4" Plastic Long Lever, common for Crane



ULN200
Chrome Plated single lever tank lever
Approx. 8"



ULN201TL
Chrome Plated single lever tank lever.
Approx. 8"

Western POTTERY, L.L.C.



H-T8W White. Fits T8ULF
H-T8HPW White. Fits T8HP
H-T5W White. Fits T5
H-T8TU White. Fits T8ULF-TU
Western Pottery Toilet Flush Handle.

Western POTTERY, L.L.C.

New!



ULN200EL
Eljer side mount tank lever. Chrome-plated. For Emblem tanks.



New!



416283
Caroma Dual Flush Push Button. White finish. Use with Sydney tank.

TOTO



THU225#CP
Toto Soiree Trip Lever, Polished Chrome Plated

TOTO



THU068#CP
Toto Drake Trip Lever, Polished Chrome Plated. (Use 1059 for Non Oem version)

TOTO



1059
Toto tank lever side mount

TOTO



THU061#CP
Toto Carusoe Side Mount Trip Lever, Polished Chrome Plated

TOTO



THU004#CP
Toto Trip Lever, Polished Chrome Plated

TOTO



THU164#CP
Toto Nexus Trip Lever, Polished Chrome Plated

TOTO



THU141N#CP
Toto Trip Lever, Polished Chrome Plated

TOTO



THU191#CP
Toto Lloyd Trip Lever, Polished Chrome Plated

TOTO



THU340#CP
Toto Dual Flush Push Button, Polished Chrome Plated

TOTO



THU314#CP
Toto Dual Flush Push Button, Polished Chrome Plated

Vortens



ULN201VW White Vortens toilet tank lever. 8" plastic. Fits Vienna RF, Vienna ELX, and Rhodas ADA 3464, 3465, 3466 toilets

Vortens



V189 Chrome, 9-1/2" Vortens Metal Tank Lever. Right Hand. Fits Palermo, Regency RF, Genova, and Velezza 3126, 3450, 3450-L, 3421, 3416.

Vortens



V227 White, 7-1/2" Vortens Plastic Tank Lever. Side Mounted. Fits Forza ADA, Forza EL, Forza RF, Loretto ADA, Loretto EL, and Loretto RF 3469, 3475

WATER MATRIX



C7715-9
Water Matrix Proficiency Toilet Tank Push Button. Use with N77 series

24 HR.



Order by
4pm for
24-48hr shipping
to almost anywhere in
Canada!

Locations

Edmonton S
5020 - 75 St.
(780) 461-2929
Fax: 780-465-4271

EDMONTON D/T
MegaCenter
11413-120 St
(780) 426-2673
Fax: 780-784-1222

CALGARY
MegaCenter
#101, 5760 - 9th Street SE
(403) 243-6662
Fax: 403-243-9368

RICHMOND
MegaCenter
7671 Alderbridge Way
(604) 273-7377
Fax: 604-279-2310

Saskatoon
411A - 50th St. E.
(306) 955-2673
Fax: 306-955-3992

Surrey
#101, 5433 - 152 Street
(604) 575-9727
Fax: 604-575-5077

Winnipeg
1370 Sargent Ave.
(204) 775-8409
Fax: 204-786-5718

Hamilton
16 Brockley Drive
(905) 560-2673
Fax: 905-560-2405

SCARBOROUGH
MegaCenter
2161 Midland Ave.
(416) 412-7278
Fax: 416-412-7890

London
1761 Oxford St. East
(519) 451-2300
Fax: 519-451-3361

Windsor
Unit 1, 5900 Rhodes Dr.
(519) 250-0000
Fax: 519-250-8621

MISSISSAUGA
MegaCenter
Unit 5-4800 Eastgate Parkway
(905) 625-1267



Bathroom Sinks

American Standard

Ovation
Enamelled Steel



0222000.020 White
0222000.021 Bone
Vinyl Sealing Rim Pull Down Clamps Included. 4" centerset. Front Overflow & Soap Dish Depression. 20.5" x 17". *Faucet Not Included*

American Standard

Ovalyn Undermount
Vitreous China



0496221.020 White
American Standard Ovalyn Undermount Sink. China, unglazed rim, front overflow, c/w mounting kit, Bowl size 19" x 16"

American Standard

Studio
Vitreous China



0643001.020 White
American Standard Studio Drop-In China Sink. Front overflow, self rimming. Single hole faucet. 21" x 17-3/4"

contrac
FOREMOST

CURTIS Semi Oval
Vitreous China



4140BEW White
Drop-in and Front overflow. 4" centerset. Replacement for the Crane Coronette 21" x 17-3/4"
Faucet not included

American Standard

Yorkdale
Enamelled Steel



0203000.020 White
0203000.021 Bone
Self Rimming, Vinyl Sealing Rim & Pull Down Clamps Included. 4" centerset. Front Overflow & Soap Dish Depression. 21" x 17". *Faucet Not Included*

American Standard

Coronette
Enamelled Steel



1630004.020 White
1630004.021 Bone
D-shaped drop in lavatory basin with vinyl cush'n'seal ring, soap depression and pivot clamps, front overflow, 4" centers. 21" x 17"
Faucet not included

American Standard

Studio Carré
Vitreous China



0642001.020 White
Drop-in with rear overflow, self-rimming, 4-3/4" deep curved bottom bowl, single hole faucet mount. 16-3/8" x 16-3/8"

contrac
FOREMOST

CATALINA Oval
Vitreous China



4140BGW White
Drop-in and Front overflow. 4" centerset. Great value replacement for most Oval drop-in sinks 20" x 16-7/8"
Faucet not included

American Standard

Colony
Vitreous China



0346403.020 White
American Standard Colony Vitreous china Lav Sink. Self rimming, 4" centerset. Front overflow, c/w template. 20-1/2" x 17-5/8"
Faucet not included

American Standard

Colony II
Enamelled Steel



0202004.020 White
Self rimming countertop sink. 4" centerset. Front overflow. Clamps Included. 2 soap depressions. Front Overflow. 20" x 17".
Faucet Not Included

contrac
FOREMOST

LOLAND Square
Vitreous China



4440BST White
Drop-in china sink with front overflow. 4" centerset. Template included. 21" x 18"
Faucet not included

contrac
FOREMOST

CAILYN Round
Vitreous China



4140BRW White
Drop-in and Front overflow. 4" centerset. Great value replacement for most Round drop-in sinks! 19" x 19"
Faucet not included



American Standard **Lucerne**



0355012.020 4" centers
AmStd Lucerne Wall Hung Lavatory Sink. Front overflow, D shape bowl, self draining deck, back and side shields, Barrier Free. (Avail. in 8" or single hole) 20-1/2"W x 18-1/4"L

American Standard **Declyn**



0321026.020 4" Centers
AmStd Declyn Wall Hung Lavatory Sink. Rear overflow, soap depression, faucet ledge, Barrier Free, with wall hanger, faucet not incl. 18-1/2"W x 17"L

American Standard **Murro**



0954004EC.020 4" centers
0955001EC.020 1 hole
0059020EC.020 Knee Guard
0062000EC.020 Lg. Acrylic Gd.
American Standard Murro wall hung lavatory sink. Vitreous china with everclean, mount kit included, knee guard sold sep. Bowl Size 21-1/4"W x 20-1/2"W. White

Kitchen Sinks

KINDRED



PSL2020/3 3 hole, Centre drain
QSL2020/7/3* 3 hole, Rear drain
Single Sink. 20 gauge, 18-8, satin or mirror* deck, brushed bowl. 20-1/2" X 20" X 7"

KINDRED



PDL2031/3 3 hole, Centre drain
RDL2031/3* 3 hole, Rear drain
Double Sink. 20 gauge, 18-8, satin or mirror* deck, brushed bowls, with spillway, 31-1/4" X 20-1/2" X 7"

KINDRED



RS1820 Centre drain
Single Sink. No ledge. 20 gauge, 18-8, mirror rim, brushed bowl. 18" X 20" X 7"

KINDRED



RD1831/7 Rear drain
Double Sink. No ledge. 20 gauge, 18-8, mirror deck, brushed bowls, with spillway, 18-7/16" X 30-1/4" X 7"

KINDRED



RCM1826/3 3 Hole
Sink and a half. 20 gauge, 18-8, mirror deck, brushed bowls. 18-1/8" X 26-1/2" X 7"

KINDRED



RDU1831/7 Rear drain
Kindred Double bowl, undermount sink, 20 gauge, 18-8 s.s.. Silk finish rim, brushed bowls. Sink has sound dampening pads. 17 3/4" x 30 7/8" x 7"

Service Sinks



14K White
Utilatub Single Laundry Tub With Legs, 23" x 25" x 33". 20 gallon capacity. Leakproof, integrally molded-in drain with stopper. Includes finished steel legs with adjustable levelers. 4" center set faucet holes.



FLTD-II White
Fiat Double Laundry Tub With Legs, 40" x 24" x 33-3/4". Includes integral drain with stopper. Includes baked enamel steel legs with leveling devices.

FIAT

FIAT



MSB2424100 24X24X10
MSB3624100 36X24X10
Fiat Molded Stone Service Mop Basins. Installed drain body with joint connector for a 3" drain pipe. Includes dome strainer and stainless steel lint basket.



ULN1650
Lavatory Legs adjustable to fit a variety of china & enamel lavatories, chrome plated, 2" adjustment, 30" long overall



Waste kits



3265-SJ Slip Joint
3265-DC Direct Con.
 OS&B 20 gauge brass continuous waste kit for 1-1/2" sinks (Kitchen), single outlet *SJ shown in image



3267-SJ Slip Joint
3267-DC Direct Con.
 OS&B 20 gauge brass continuous waste kit for 1-1/2" sinks (Kitchen), dual outlets * SJ shown in image



808-6CP 1-1/4" X 6"
808-8CP 1-1/4" X 8"
808-12CP 1-1/4" X 12"
809-6CP 1-1/2" X 6"
809-8CP 1-1/2" X 8"
 22 Gauge Slip Fit chrome plated brass extension tubes.



6267-DC Direct Connect
6267-SJ Slip Joint
 1 1/2" Continuous Waste, Plastic, Center Outlet. *DC shown in image



6265-DC Direct Connect
6265-SJ Slip Joint
 1 1/2" Continuous Waste, Plastic, End Outlet. *DC shown in image



812-4RB 1-1/2" X 4"
812-6RB 1-1/2" X 6"
812-8RB 1-1/2" X 8"
812-10RB 1-1/2" X 10"
812-12RB 1-1/2" X 12"
 22 Gauge Rough Brass Sink Tailpiece



3850A-6 6"
 1 1/2" X 6" X 20 Ga.
3850A-8 8"
 1 1/2" X 8" X 20 Ga.
 Rough Brass Dishwasher Branch Sink Tailpiece (Connection For 1/2" Nominal Copper)



6868-U
 1 1/2" X 8" Dishwasher Tailpiece. Universal C/W Washers

P.O. Plug



3600Q-CP
 1-1/4" X 6-3/4", Pop Up, Chrome plated, with Clicker Stop Top



ULN672
 1 1/4" x 8" P.O. Plug with grid strainer, chrome



3697A
 1 pc. 1 1/4" X 8" Brass Chrome plated P.O. Plug with Plug & Chain



33W570
 1 pc. 1 1/4" X 8" Brass Chrome plated P.O. Plug with Plug & Chain



3600
 2 pc. 1 1/4" X 6" Brass Chrome plated P.O. Plug with Plug & Chain



ULN671
 1 1/4" x 11" Vanity drain plug, off-set, cast brass grid strainers and elbow - commercial strainer



33W540
 1 1/4" X 8" P.O. Plug With Mechanical Pop-Up Stopper. 1 Piece. Chrome Plated



215-909
 Hybrid Mechanical, two piece. Pop-up 1-1/4" X 8"























3698P-CP
 1-1/4" X 8", 1 piece Brass body Pop Up, Chrome plated.



3695
 1-1/4" X 8", 3 piece Brass body Pop Up, Chrome plated

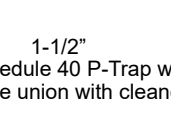

 <p>ULN437 1-1/2"/100PKG Q437 1-1/2"/ea. Tailpiece washers Poly flanged</p>	 <p>ULN438 1-1/4"/100PKG Q438 1-1/4"/ea. ULN439 1-1/2"/100PKG Q439 1-1/2"/ea. Slip joint washers tapered Poly</p>	 <p>ULN433 1-1/4"/100PKG Q433 1-1/4"/ea. ULN434 1-1/2"/100PKG Q434 1-1/2"/ea. Slip joint washers Rubber</p>	 <p>ULN317 1-1/4" R.B ULN318 1-1/4" C.P. ULN449 1-1/2" R.B. ULN450 1-1/2" C.P. Slip Joint Nuts</p>
 <p>110BRBLF 1 1/4" Rough Brass P Trap, less flange</p>	 <p>114BRBLF 1 1/2" Rough Brass P Trap, less flange</p>	 <p>110BDCP 7-1/2" Standard 110XBDCP 15" Extra Long 1 1/4" X 20 Ga. C.P. P-Trap With Deep Flange & Brass Nuts</p>	 <p>114BDCP 1 1/2" X 20 Ga. C.P. P Trap With Deep Flange & Brass Nuts</p>
 <p>FT-150 Flexible Drain Trap There's no faster, easier way to replace 1-1/4" or 1-1/2" plastic or metal drain traps than with Fernco's Qwik Trap.</p>	 <p>10227 Ground Joint 10227-1 Washer joint 1-1/2" J Bends with captured nut</p>	 <p>10140-CP Chrome 10140-RB Rough Brass 1-1/2" Ground joint, J Bends</p>	 <p>10100-CP Chrome 10100-RB Rough Brass 1-1/4" Ground joint, J Bends</p>
 <p>10R 1-1/4" 14R 1-1/2" 20 Gauge chrome plated brass repair P Traps. Shorter length to slip onto existing extension</p>	 <p>602391 1-1/4" 602409 1-1/2" ABS Schedule 40 P-Trap with adjustable union H x H</p>	 <p>103231E 1-1/2" without cleanout The Canplas PermOseal® P Trap is unlike any other P Trap. Features a gasket, ball joint, union connection makes it easier for the installer to overcome installation problems, such as pipe misalignment and offset fittings.</p>	
 <p>602433 1-1/2" ABS Schedule 40 P-Trap with adjustable union with cleanout H x H</p>	 <p>602326 1-1/2" Solid ABS P-Trap solvent cement joint</p>	 <p>860 1-1/4" 862 1-1/2" Chrome plated brass slip joint couplings</p>	 <p>864 1-1/4" 863 1-1/2" Chrome plated brass slip joint couplings, 45 degrees</p>
 <p>865 1-1/4" 866 1-1/2" Chrome plated brass slip joint couplings, 90 degrees</p>			





209-801
Turn & seal style, stainless steel body & threads, brass nuts & brass tail piece incl. Replaces strainers found in most "KIL" sinks c/w ULN420B



ULN426C
Sink strainer w/tail 4", plastic arrow head basket. 2 step closure w/brass thread and cast nuts

novanni



41-0434-A
Novanni conical style kitchen sink basket strainer assembly w/tailpiece.



ULN308 1"
ULN415 Laundry Tub
ULN415A 1-1/2"
ULN415B 2"
Chrome plated shallow crumb cup strainers



ULN420A
Stainless Steel Replacement Basket with Arrowhead Clip 31-0016



ULN418
Stainless Steel Shallow Crumb Cup Strainer 31-0017



ULN419
Stainless Steel Replacement Basket with Large Neoprene Seal. Used as a Fit-All Replacement



ULN420
Stainless Steel Replacement Basket w/Neoprene Push Down Seal



ULN420B
Non O.E.M., Easy Seal Crumb Cup For KIL Strainer 980-1



11-0908
Kindred 1135b replacement basket strainer w/ball bearing



ULN420C
Strainer replacement basket, w/plastic arrowhead



31-0512C
Novanni conical replacement strainer



ULN502
5" Rubber sink stopper



ULN501B 1" - 1 3/8"
ULN501C 1" - 1 3/8" w/chain
White Fits All Basin Plug 0492



ULN533 1"
ULN534 1-1/8"
ULN535 1-1/4"
ULN536 1-3/8"
ULN537 1-1/2"
ULN539 1-3/4"
White Basin Plug



3698-1 Kit
3698-2 Nut
3698-CLIP Clip Only
Fits OS&B brand Pop-Up Rod & Strap with "V" Clip. For Most Popular Pop-Up Drains. 3 Pc. Arm Kit

DELTA



ULN347
Delta Pop-Up Stopper 5468. 80194923 OEM



14014 Small 5" L x 1.22" Dia
14015LC Large 5.09" L x 1.35" Dia
Universal replacement mechanical PO Plug stoppers.



14005LC
Delta replacement mechanical PO Plug stopper. 5.09" L x 1.35" Dia



3698-3
OS&B Drop Plug, drop stopper



14008
Moen replacement mechanical PO Plug stopper. 5" L x 1.23" Dia



ULN532
Neoprene backwater preventer for sinks



ULN307A
N.P. Brass Type "A". Bead Chain. Coupler (ea.)



ULN307C
C.P. Basin Plug Ring. (25/pkg.) 1135



ULN307 11"
ULN307D 15"
ULN357 per foot
N.P. Brass Bead Chain. w/couplings. Per foot includes connectors



ULN307B
N.P. Brass Type "B" Bead. Chain Couplers (50/pkg.) 1133A



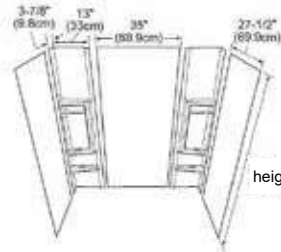

New!
Thicker
Walls



39240* 58" H

40164** 80" H

The Elite bathtub surround. Polycomposite, attractive and affordable, ideal for improving the look of any bathroom. 5-piece design. 6 shelves and 2 towel bars. White

* Fits alcoves 49"-60.5" wide x 28"-31" deep

**Fits alcoves 49"-60" wide x 28"-31" deep

American Standard



0184000.020 Left Hand
0182000.020 Right Hand

American Standard - Colony
60"L x 30"W x 16-1/4"H - White
Porcelain on steel construction. Recess Bath with integral apron and tiling flange. End drain outlet and above floor rough-in. *Also Available in Linen, Bone or Silver Grey*



American Standard



AM00495400.213 Tub Doors, Chrome

2530102.020 Tub, Right Hand

2530202.020 Tub, Left Hand

American Standard white acrylic tub with optional door and wall kit.

Tub:

60"W x 30"L x 18.5"H Acrylic high gloss finish, textured bottom, 3 sided tiling flange, curved apron design

Doors:

Chrome 60"W bypass, 1/4" glass, for use only with 2530 series tub

Walls:

60"W x 30"L x 58"H, direct to stud install, acrylic high-gloss everclean finish, 6 deep shelves

American Standard

Designed for easy
Retrofits to steel tubs



1752102.020 Right Hand

1752202.020 Left Hand

American Standard Evolution II Acrylic Tub. High gloss tough acrylic surface with fiberglass reinforcement. Integral apron for alcove install, tiling flange, standard sized drain location for easy retrofit, contemporary design.
60-1/4"L x 30-1/4" W x 15"H



1113 Chrome
Universal tub spout. Fits 3/4" or 1/2" thread, 1/2" slip fit and 1/2" nose thread. c/w wrench, teflon & adapters.



ULN195F Chrome
With diverter, can be used as slip fit or 1/2" & 3/4", universal fit



ULN197
Telephone shower diverter spout (top outlet) C.P. Threaded at wall end.



ULN197A
C.P. Telephone Shower Diverter. Spout (Side Outlet) 10-4014-8. Threaded at wall end. 1/2" or 3/4" threads

DELTA



2004-TP
Delta Slip-on non-diverter tub spout. Chrome Finish. 1/2" IPS



ULN196D
Waltec tub spout, 3/4" coarse thread with 1/2" fine thread bushing threaded at nose end, chrome plated



3931
Moen diverter tub spout 1/2" slip fit



3142-095
Diverter spout, 1/2" threaded at nose end

DELTA



U1072-PK
Delta Tub Spout Add-A-Shower Extra-Long 5-1/4" Diverter Tub Spout Slip-Fit and Threaded 1/2" and 3/4" Connections Hose to Hand Shower



ULN195
Diverter spout, pull up diverter with 1/2" or 3/4" thread fitting

DELTA



2001-TP
Pull Up Diverter
2003-TP
Pull Down Diverter
Delta tub spouts with diverters, 1/2" Slip Fit connection



DELTA



2002-TP
Pull Up Diverter
2005-TP
Pull Down Diverter
Delta tub spouts with diverters, 1/2" Threaded IPS connection

Flashing Your Tub Surround
When installing your tub surround

- you should apply your adhesive to both surfaces - make surfaces contact - then quickly separate.

Let stand for recommended curing time (Avg. 3 min.) and then place tub surround in place.



Renovating?
Call us for a competitive Reno Quote and ask about our full selection of plumbing!





6040QK-CP Chrome
OS&B ABS Offset waste and tub drain kit with clicker, *pipe not included*



6040CS
A.B.S. waste & overflow kit, Plug & Chain, Large strainer, with new slide on faceplate. *pipe included*



314CS-S Plug & Chain
OS&B Brass Offset waste and tub drain kit.



571711 Lift & Turn
ABS Waste Elbow 1 1/2" Kit, less pipe, two hole chrome. plated finish, pull and turn. stopper, *pipe not included*



URTKCLQ-CP Chrome
URTKCLQ-BN Brushed Nickel
OS&B Tub Drain Update Kit. Change the look and finish of your Tub Drain in minutes & at a fraction of the cost of a full replacement. Incl. Screwless SlideOn faceplate & Clicker plug. **Not for use with Lift & Turn closure, Trip Lever or Cable drains.*



URTKCLQ-CP



URTKCLQ-BN



129-501
Bathtub Trim Kit gives a new look, includes faceplate with 1 or 2 hole mounting screw, fits most 1-1/4" and 1-1/2" thread size bath wastes



320CP-S 1/4" Post
320CP-L 5/16" Post
OS&B Push Pull cartridges, plastic chrome top, tub drain stopper, note post sizes



343CP-S
1-5/8" X 16TPI
343CP-L
1-7/8" X 11.5TPI
OS&B lift and turn drain assemblies, please note size of strainer and threads per inch, chrome top, tub drain stopper



Commercial Grade Solid Brass



330BCP-S 1/4" Post
330BCP-L 5/16" Post
OS&B Clicker cartridge, brass top chrome plated, used in tubs and lavs, note post sizes



13774L Chrome
Waste and overflow trim kit - universal fit for 1-1/2" and 1-3/4" - tip toe style



341CP 5/16" Post
OS&B Tip Toe Tub Drain Stopper, chrome, gasket available separately order 415OSB



338CP-L
Large Strainer. Brass. Accepts Large(5/16") Clicker® and Push-Pull. Coarse - 11-1/2 threads (per inch). Trade designation 1-1/2".



338CP-S
Small Strainer. Brass. Accepts Small(1/4") Clicker® and Push-Pull. Fine - 16 threads (per inch). Trade designation 1-3/8".



ULN501
1 1/2" - 2" Bath plug



ULN199C Bevelled
ULN199TW Tapered
Tub Overflow gaskets



ULN199D Flat
Tub Drain gasket for shoe strainer



350P
Bar Only
ULN198C
Bar & Screw
White plastic overflow tie bar with or without screw



ULN199BR
Overflow bracket plate. Metal.







ULN199B 1 Hole
Waste & Overflow Plate, Chrome finish.



324CP 2 Hole
Waste & Overflow Plate, Chrome finish.



 <p>2002 1.5 GPM P2001 2.5 GPM Sure flow adjustable showerhead, brass ball joint</p>	 <p>ULN505LF 1.75GPM/Brass Ball ULN505B 2.5GPM/Plastic Ball Chrome A.B.S. Showerhead, High Strength</p>	 <p>RAI130-31 Chrome RAI130-32 White Showerhead 1 1/4" . Concentrated Fine Spray, 2.5 GPM</p>	 <p>MOEN 6300EP Chrome 1.75gpm Moen Showerhead. 2-1/2" diameter, Easy clean</p>	
 <p>MOEN 12894 Chrome Moen Commercial Showerhead, arm and plate. 2.5gpm, vandal resist, adj spray, chrome plated brass</p>	 <p>BrassCraft BC2102MB Chrome Multiple spray: full, massage, combination & pause control. Finger touch adjusting ring.</p>	 <p>DELTA 4141-TP Delta Shower head and arm kit. Chrome, 2.0 gpm</p>	 <p>DELTA 675CPK Chrome 675PK White Delta Showerhead. 3 setting, full cross, full body and massage. 2.5gpm</p>	
 <p>WALTEC 20D330 Delta Waltec FloTrol OEM shower head 2.2 GPM, solid brass, chrome plated</p>	 <p>2036 Solid brass adjustable shower head. Chrome finish. 1-3/4" dia. 2.0 GPM</p>	 <p>1208 Deluxe 3 function chrome shower head. Fingertip control. 1.5 GPM, chrome finish</p>	 <p>1204 Speakman style shower head. Chrome plated brass, 6 jet adjustment, 2.5 GPM</p>	 <p>DELTA 52653-PK Chrome Water Efficient 1.50 gpm WaterSense®</p>
 <p>DELTA 52634-20-PK Chrome 5-Settings. Delta Premium Touch-Clean® Water pause 2.0 gpm WaterSense®</p>	 <p>DELTA 52636-PK Chrome Delta 5-Settings, Touch-Clean® 2.0 gpm, WaterSense®</p>	 <p>DELTA 4900PK Delta Vacuum Breaker. Shower arm mount, chrome plated brass shield</p>	 <p>ULN503 Chrome 1/2" I.P.S. X 6" Brass Shower Arm With C.P. Flange 189</p>	 <p>RAI033-42 White Rodam Economic Hand shower kit, 2.5gpm, w/ pause button, nylon reinforced hose & wall bracket.</p>
 <p>BrassCraft BC2202 Chrome BC2201 White Brass Craft shower head. Anti-clog rubber tips for easy cleaning. Tangle free hose design. Four settings. Includes 60" hose and mounting bracket.</p>	 <p>RAI010-42 White RAI010-43 Chrome JUPITER Kit 4 Settings, Soft Spray, Massage, Soft Spray + Massage, Hose. White nylon reinforced hose w/brass & plastic fitting, and white shower arm</p>	 <p>DELTA 59202-PK Universal Showering Fundamentals™ 4-Setting Touch-Clean®, 2.5 gpm, ADA compliant</p>	 <p>DELTA 54424-PK Universal Showering ActivTouch® 9-Settings Pause feature, 2.5 gpm, ADA compliant</p>	



Head/Bracket Only



ULN511SH Standard White economy plastic personal shower head and bracket. Hose sold separately.

Head Only



RAI630-13 Chrome
RAI630-12 White
Rodam 'Fila' Handshower Replacement Head, 3 setting full, massage & combo, 2.5gpm, rub clean spray holes

DELTA Head Only



59462-B-PK* Chrome
59462-WH-PK White
462BPBK* White
TouchClean, Flow Rate: 2.5 gpm, 1 setting, w/pause*

DELTA Head Only



59465-WH-PK White
59465-PK Chrome
Delta Handshower Replacement Head. 4 Setting cross full, full, massage and cross/massage, 2.5gpm

DELTA Head Only



59434-20-PK Chrome
5 Settings, Pause feature, ADA compliant 2.0 gpm

DELTA



New!

58569-PK Chrome
Delta In2ition 2-in-1 showerhead and hand shower. 5-settings. w/ mount and hose

Bungy Stretch



RAI252-31 59" to 78"
RAI254-31 78" to 110"
S.S. Bungy hose chrome, unique stretch capability and high quality.

DELTA



U495D-60-PK* 60" to 82"
U494R-70-PK 70"
U494R-84-PK 84"
Delta UltraFlex® hose
White/Chrome Ribbon Hose. Two chrome metal conical hose nuts. (Stretchable metal)*.



RAI139-32
White flexible 59" hose



RAI139-30
White nylon 59" hose



ULN511E 72"
Chrome stretchflex pvc shower hose.



ULN511C 59"
ULN511CS 72"
Stainless Steel metal stretchflex shower hose.



ULN511WBC
Hand Shower, Swivel Connector and Wall Bracket C.P. Metal with screws and plugs



RAI527-31
Universal swivel in solid brass chrome finish. Heavy Duty Quality

DELTA



4002CPK Plastic
U5002-PK Metal
Delta solid brass handshower holder for pin mounts, chrome



RAI526-31
Solid Brass wall hook. chrome finish. Heavy Duty Quality

DELTA



U5001-PK
Delta Handshower Wall Pin Mount. Chrome with clear pin.



RAI175-31 Chrome
RAI175-32 White
Wall Bracket. 3 positions ABS.



RAI170-31 Chrome
RAI170-32 White
Shower arm, ABS

DELTA



New!

U6300-WH
ADA Compliant Grab Bar Hand Shower Mount. White. Fits 1-1/2" and 1-1/4" grab bars.

DELTA



U4922-PK Chrome
Delta Universal Shower Arm Diverter for Hand Showers.

DELTA



U3401-PK Chrome
Delta Adjustable Hand Shower Arm Mount. Mounts hand shower to shower arm

DELTA



U4980-PK Chrome
Delta Hand Shower Wall Supply Elbow. Replaces standard shower arm. Brass construction

DELTA



U3001-PK Chrome
Delta Hand Shower Wall Mount.



ABS Fittings

ABS Schedule 40 Copper Adaptors HUB X SLIP JOINT For Waste Copper

SIZE	1-1/4"	1-1/2"	2"
	601872	601898	601906

ABS Trap Adaptor (female) HUB X SLIP JOINT For Sink Tailpipes

SIZE	1-1/4"	1-1/2"	1-1/2" x 1-1/4"
	601922	601948	601930

ABS Schedule 40 Cleanout with Plug Inlet SPIGOT X CAP

SIZE	1-1/4"	1-1/2"	2"	3"
	602961	602979	602987	602995

ABS Schedule 40 1/4 Bend, 90° H X H (Hub x Hub)

SIZE	1-1/4"	1-1/2"	2"	3"	4"	4" X 3"
	600593	600601	600627	600643	600676	600668

ABS Schedule 40 1/4 Bend 45° H X H (Hub x Hub)

SIZE	1-1/4"	1-1/2"	2"	3"	4"
	600882	600890	600916	600932	600940

ABS Schedule 40 22.5° Elbow with H X H (Hub x Hub)

SIZE	1-1/4"	1-1/2"	2"	3"	4"
	601039	601047	601054	601062	601070

ABS Schedule 40 1/4 Bend Street 90° Street Elbow S X H

SIZE	1-1/4"	1-1/2"	2"	3"	4"
	600718	600726	600742	600759	600767

ABS Schedule 40 1/4 Bend 22.5° SPIGOT X HUB

SIZE	1-1/2"
	601096

ABS Schedule 40 1/8 Bend 45° ELL SPIGOT X HUB

SIZE	1-1/4"	1-1/2"	2"	3"	4"
	600965	600973	600999	601005	601013

ABS Fittings

ABS Schedule 40 Coupling H X H (Hub x Hub)

SIZE	1-1/4"	1-1/2"	2"	3"	4"
	601112	601120	601138	601146	601153

ABS Schedule 40 Female Adaptor HUB X FIP

SIZE	1-1/4"	1-1/2"	2"	3"	4"
	601377	601385	601393	601401	601419

ABS Schedule 40 Male Adaptor HUB X MPT

SIZE	1-1/4"	1-1/2"	2"	3"	4"
	601260	601286	601294	601302	601310

ABS Union SPIGOT X FPT

SIZE	1 1/2"	2"
	602110	602128

ABS Schedule 40 Sanitary Tee 45° H X H X H A X B X C

SIZE	1 1/4"	1 1/2"	2"	3"	4"
	600007	600015	600023	600031	600049

ABS Schedule 40 90° Line Cleanout H X H (Hub x Hub)

SIZE	1 1/2"	2"	3"	4"
	602854	602862	602870	600270

ABS Double Wye H X H X H X H A X B X C X D

SIZE	1 1/2"	2"	3"	4"
	600528	600536	600544	600551

ABS Dishwasher Wye









SIZE	1 1/2" X 1 1/2"
	600809

Don't forget
to login to see
wholesale pricing
www.amresupply.com



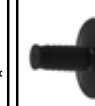

ABS Fittings

	ABS Schedule 40 P-Trap with adjustable union H X H	1 1/2" 2" 3" 4"	602391 602409 602342 602359						
	ABS Schedule 40 P-Trap with adjustable union with cleanout H X H	1 1/2" 2" 3" 4"	602433 602334 602342 602359						
	ABS Schedule 40 Flush Bushing SPIGOT X HUB	1 1/2" X 1 1/4" 2" X 1 1/2" 3" X 2" 4" X 3" 4" X 2" 4" X 2"	601542 601567 601609 601559 601583 601575						
	ABS Schedule 40 Coupling H X H (Hub x Hub)	1 1/2" X 1 1/4" 2" X 1 1/2" 3" X 2" 4" X 3" 4" X 2"	601179 601195 601211 601252 601245						
	ABS Schedule Adaptor to MJ Cast Iron	2" 3" 4" 4" X 3"	601740 601757 601781 601773						
	ABS Schedule 40 45° Wye H X H X H (A x B x C)	1-1/4" 1-1/2" 2" 3" 4"	600387 600395 600403 600411 600429						
	ABS/DWW Schedule 40 Dishwasher Bushing	1-1/2" 2" 3" 4"	600387 600395 600403 600411 600429						
	ABS Trap Adaptor SPIGOT X SLIP JOINT [for sink tailpipes]	1-1/4" 1-1/2" 1 1/2" X 1 1/4" 1 1/2" X 1 1/2" OR 1 1/4"	601971 601997 601989 602011						
	ABS Schedule 40 Socket Cap, Hub	1-1/2" 2"	602540 602557						

ABS Fittings

	ABS 1-1/4" to 4"	Part Size	
		114ABSP 1 1/4"	
		112ABSP 1 1/2"	
		2ABSP 2"	
		3ABSP 3"	
		4ABSP 4"	

ABS Pipe Sold by Foot, comes in 12 foot Lengths, we do not ship 12ft lengths, Not stocked at all locations

V-200 1-1/2" OS&B Automatic Plumbing Vent. Designed to prevent backflow of sewer gases and trap siphonage at the fixture.



39018 1-1/2" or 2" Oatey Sure-Vent. Air admittance valve (AAV) Eliminate the need of a vent for plumbing. 20DFU rated. Ideal venting for island sinks, remote bathrooms and remodeling and more. ABS Schedule 40 fits 1-1/2" or 2" ABS.



601799 1-1/2" x 1-1/2" 1-1/2" ABS HxH Backwater Valve or Sewage Check Valves - ABS DWV Schedule 40. Prevents back flow of sanitary sewer, storm sewer or septic systems. With access cover.



617-025 Copper
613-025 Galvanized
Pipe Strapping. 25' roll. 24 gauge



POWER WRAP REPAIR
If You Can WRAP IT... You Can REPAIR IT!



FPW248CS 2" x 48"
FPW3132CS 3" x 132"
FPW4252CS 4" x 252"

Water Activated Fiberglass is a strong, permanent and economical repair. Works on virtually every kind of pipe and hose. Alternative to cementing, soldering, welding, sleeving and replacement. Works on wet, dry, clean, dirty or corroded pipes. Even works under water... salt or fresh.

Hose Clamps

Standard Gear design, 1/2" wide stainless steel band with plated screw

Part#	Min	Max
HS6F	3/8"	7/8"
HC6-8	7/16"	1"
HS10	1/2"	1-1/16"
HS12	9/16"	1-1/4"
HS16	11/16"	1-1/2"
HS20	7/8"	1-3/4"
HC6-24	1-1/16"	2"
HC6-28	1-5/16"	2-1/4"
HC6-32	1-13/16"	2-1/2"
HC6-40	2-1/16"	3"
HC6-48	2-9/16"	3-1/2"
HC6-56	3-1/16"	4
HC6-60	3-5/16"	4-1/4"
MC4ZW	2-1/2"	4-1/2"
HC6-104	5"	7"
HC6-152	8"	10"

Thin Band Gear design, 5/16" wide stainless steel band with plated screw

Part#	Min	Max
HC6-4TB	5/16"	5/8"
HC6-6TB	7/16"	7/8"



abs . hose clamps

Fittings



Check out www.amresupply.com for a full selection of fittings! abs, brass, copper, plastic and pex



FERNCO.



QC-101 1-1/2"
QC-102 2"
 Fernco Qwik Cap, to cap pipe ends, cap for testing and for clean outs

FERNCO.

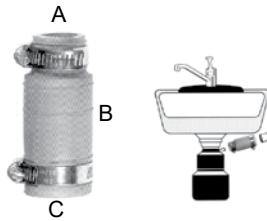

DWC-100
 Dishwasher Drain Connector
 A = 1", B = 2-3/4", C = 1-1/4"

FERNCO.



QL-150 1-1/2" X 1-1/2"
QL-200 2" X 2"
QL-300 3" X 3"
QL-400 4" X 4"
 Fernco Quick Elbow

FERNCO.

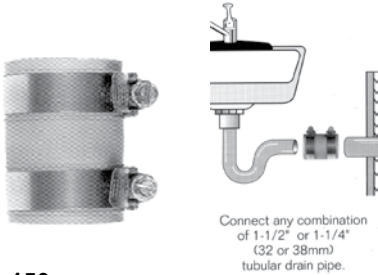

TC-150
 Tubular Drain Pipe Connector. Fits both 1-1/2" and 1-1/4" both ends

Connect any combination of 1-1/2" or 1-1/4" (32 or 38mm) tubular drain pipe.



FT-150
 Qwik Trap, fast & easy way to replace 1-1/4" or 1-1/2" plastic or metal drain traps

FERNCO.



DTC-150 1-1/2" X 1-1/2" or 1-1/4"
DTC-215 2" X 1-1/2" or 1-1/4"
 Tubular traps to all common 2" drain piping.



QT-150 1-1/2" x 1-1/2" x 1-1/2"
QT-200 2" x 2" x 2"
 Qwik Tees let you connect common household drain, waste and vent pipes without using special tools or fittings.

Used For:
 Cast Iron, Plastic, Copper, Steel or Lead



Part#	Size
1056-100	1" X 1"
1056-125	1-1/4" X 1-1/4"
1056-150	1-1/2" X 1-1/2"
1056-150/125	1-1/2" X 1-1/4"
1056-215	2" X 1-1/2"
1056-22	2" X 2"
1056-32	3" X 2"
1056-33	3" X 3"
1056-44	4" X 4"



FERNCO.

Other sizes available!
 SEE WEBSITE



Couplers for Cast Iron or schedule 40 plastic pipe
NH-150 1-1/2"
NH-22 2"
NH-33 3"
NH-44 4"
NH-215 2" X 1-1/2"



1279001 1-1/2"
 Flexitrap Flexible Rubber P-Trap. Will replace all kitchen and bathroom sink traps. Adjusts for misalignment's

2700	1/2"
2701	3/4"
2702	1"
2703	1-1/4"
2704	1-1/2"
2705	2"

Truehugger Repair Clamp. Twin gear clamps open completely for easy install, neoprene rubber



FERNCO.

Expansion joints. Allow for thermal expansion and contraction of drain, waste and vent pipes.



XJ-150	1-1/2"
XJ-2	2"
XJ-3	3"
XJ-4	4"

Pipe Repair Clamps

Part#	Part#	IPS
3" Length	6" Length	
1 Bolt	2 Bolt	
2660	2674	1/2"
2661	2675	3/4"
2662	2676	1"
2663	2677	1-1/4"
2664	2678	1-1/2"
2665	2679	2"
2666	2680	2-1/2"
	2681	3"
2669	2683	4"

For Copper Pipe



Stainless steel band, Neoprene gaskets, Plated Steel bolt nut & washer. Temporary repairs for split pipes.







COPPER

BIBOW

	Short 90° Elbow C X C						
	SIZE	1/2"	3/4"	1"	1 1/4"	1 1/2"	2"
		477109	477117	471771	471789	471797	471805

	Copper 90° Street Short Turn, Elbow FT X C	
	SIZE	1/2" 3/4" 1"
		477125 477133 471961

	Drop Ear 90° Elbow C X FIP	
	SIZE	1/2" 3/4"
		9440-030

	90° Drop Ear Elbow C X C	
	SIZE	1/2" 3/4"
		474049

	45° Elbow Copper C X C						
	SIZE	1/2"	3/4"	1"	1 1/4"	1 1/2"	2"
		477091	477216	471664	471672	471680	471698

	45° Elbow Copper F X C	
	SIZE	1/2" 3/4"
		477083 477026

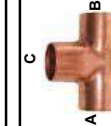
	Copper Tee C X C X C (A x B x C)						
	SIZE	1/2"	3/4"	1"	1 1/4"	1 1/2"	2"
		477141	477224	472258	472266	472274	472282

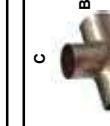
	Reducing Tee C X C X C (A x B x C)			
	SIZE	1/2" X 1/2" X 3/4"	3/4" X 3/4" X 1/2"	1" X 1/2" X 3/4"
		477232	477158	472423
	SIZE	1" X 3/4" X 1"	1" X 1" X 1/2"	1" X 1" X 3/4"
		452532	475038	474932

	C X C Copper Coupling	
	SIZE	1/2" 3/4"
		477042 477059 470062 470070 470088 470096

Check our website for many more instock specialty fittings!
www.amresupply.com

COPPER

BIBOW

	C X C Copper Reducing Coupling				
	SIZE	3/4" X 1/2"	1" X 3/4"	1 1/4" X 1"	1 1/2" X 1 1/4"
		477067	470278	470310	470351

	Fitting X C Copper Bushings	
	SIZE	3/4" X 1/2" 1" X 3/4" 1" X 1/2"
		477075 470567 475731

	Copper End Tube Cap						
	SIZE	1/2"	3/4"	1"	1 1/4"	1 1/2"	2"
		477166	477174	473595	473603	473611	473629

	Union C X C Brass Fittings	
	SIZE	1/2" 3/4"
		42SW-10 42SW-14

	FIP X C Brass Fittings	
	SIZE	1/2" 3/4"
		46SW-10D 46SW-14E

	MIP X C Brass Fittings	
	SIZE	1/2" 3/4"
		48SW-10D 48SW-14E



Copper Type L
1/2" to 2"
Copper Type M
1/2" to 2"

Copper Pipe
Commercial Grade, Type L (Pipe I.D. color green)
(Commonly used for heating systems)
Part # Size Wall Size
12CPTL 1/2" .040
34CPTL 3/4" .045
1CPTL 1" .050
114CPTL 1-1/4" .055
112CPTL 1-1/2" .060
2CPTL 2" .070
212CPTL 2-1/2" .065
3CPTL 3" .072

Copper Pipe
Type M (Pipe I.D. color red)
(Commonly used for potable water)
Part # Size Wall Size
12CPTM 1/2" .028
34CPTM 3/4" .032
1CPTM 1" .035
114CPTM 1-1/4" .042
112CPTM 1-1/2" .049
2CPTM 2" .058









Sold by the foot. We do not ship, comes in 12 ft lengths, not stocked at all locations

Check our website for a huge selection of Sharkbite, easy to use, push-on fittings - For a fast solution to working with Pex!
www.amresupply.com







THE SHARKBITE® CONNECTION SYSTEM

Lightning Fast. Won't Leak. Go.



PEX

	Coupling Brass Barb (Pex) X Barb (Pex) SIZE 1/2" 3/4" 1 1/2" X 1/2" 3/4" X 1/2" 540138 540153 540146
	Female Adaptor Brass Barb (Pex) X Hub SIZE 1/2" 3/4" 541490 541672
	Male Adaptor Brass Barb (Pex) X Fitting SIZE 1/2" 3/4" 540369 540385
	Male Adaptor Brass Barb (Pex) X MPT SIZE 1/2" 3/4" 1 1/2" X 3/4" 3/4" X 1/2" 540252 540260 540286 540294
	Female Adaptor Brass Barb (Pex) X FPT (Pex) SIZE 1/2" 3/4" 540203 540211 540229 540237
	Female Adaptor Brass Barb (Pex) X SWIVEL SIZE 1/2" 540245
	Elbow Brass Barb (Pex) X Barb (Pex) SIZE 1/2" 3/4" 3/4" X 1/2" 542001 542019 542027
	Elbow Brass Barb (Pex) X MPT SIZE 1/2" X 1/2" MPT 540120
	Coupling Brass Pex Barb X Poly B Barb SIZE 1/2" 3/4" 510131 510156

PEX

	Pex Brass Plug SIZE 1/2" 3/4" 1" 1 1/4" 2" 540427 540435
	Pex Compression Rings - Copper (Black) 10/pkg SIZE 3/8" 1/2" 3/4" 1 1/4" 1 1/2" 2" 540757 540187 540195
	Tee Brass, Barb (Pex) X Barb (Pex) X Barb (Pex) - (A x B x C) SIZE 1/2" 1/2" X 1/2" X 3/4" 3/4" 542035 542050 542043
	Tee Brass, Barb (Pex) X Barb (Pex) X Barb (Pex) - (A x B x C) SIZE 3/4" X 3/4" X 1/2" 3/4" X 1/2" X 3/4" 542084 542068 542076
	(Pex) Barb X FPT SIZE 1/2" 540112
	90° Brass Wing Elbow

PEX

	PEX Hot/Cold Tubing for water potable plumbing (Sold EA, not/ft.) Part # Size Length 588822 1/2" 10ft 588707 1/2" 20ft 588855 1/2" 100ft 588806 3/4" 10ft 588798 3/4" 20ft 588939 3/4" 100ft
	PEX Hot/Cold Tubing for water potable plumbing (Sold EA, not/ft.) Part # Size Length 588822 1/2" 10ft 588707 1/2" 20ft 588855 1/2" 100ft 588806 3/4" 10ft 588798 3/4" 20ft 588939 3/4" 100ft



U860R5 Red 5ft
U860B5 Blue 5ft
U860W5 White 5ft

SharkBite PEX is a cross-linked polyethylene tubing best suited for potable water supply application. Short lengths are perfect for easy transport and small jobs.



PART # 1592306
SIZE 1/2" or 3/4"
 Pex Combo Crimping Tool. 14" length



9285-100
 Pex Pocket Crimper. Crimp using your own 10" Vice Grips! One tool for 3/8", 1/2" & 3/4" sizes. Includes tool, pouch and "Go/No-Go" size gauge.





Now Lead Free!

Straight Connector

- U072** 1/2" X 1/2" FNPT
- U088** 3/4" X 3/4" FNPT
- U094** 1" X 1" FNPT
- U120** 1/2" X 1/2" MNPT
- U134** 3/4" X 3/4" MNPT
- U140** 1" X 1" MNPT
- Reducing Connector**
- U068** 1/2" X 3/4" FNPT
- U116** 1/2" X 3/4" MNPT
- U118** 3/8" X 1/2" MNPT

Elbow

- U246** 3/8" X 3/8"
- U248** 1/2" X 1/2"
- U256** 3/4" X 3/4"
- U274** 3/4" X 1/2"
- U260** 1" X 1"
- U280** 1/2" X 1/2" MNPT
- U308** 1/2" X 1/2" FNPT

Tee

- U360** 3/8" X 3/8" X 3/8"
- U362** 1/2" X 1/2" X 1/2"
- U370** 3/4" X 3/4" X 3/4"
- U374** 1" X 1" X 1"
- Reducing Tee**
- U412** 3/4" X 3/4" X 1/2"
- U444** 3/4" X 1/2" X 3/4"
- U454** 3/4" X 1/2" X 1/2"
- U416** 1" X 1" X 3/4"

Don't forget to deburr your pipe to ensure a proper fit.



U702

Sharkbite Safe Seal Tool- Deburring and depth gauge all in one. For 1/4", 3/8", 1/2", 5/8", 3/4" and 1" PEX, copper and CPVC pipe.

Drop Ear Elbow
U249 1/2" X 1/2"
Non-threaded

Straight Coupling
U006 3/8" X 3/8"
U008 1/2" X 1/2"
U016 3/4" X 3/4"
U020 1" X 1"

U3008 1/2"
U3016 3/4"
U3020 1"
Slip Coupling

Disconnect Clip
U710 1/2"
U712 3/4"
U714 1"

Check Valve
U2008 1/2"
U2016 3/4"

U3362 1/2"
U3370 3/4"
Slip Tees

24983CA 1/2" X 1/2" X 1/4" COMP
24984CA 1/2" X 1/2" X 3/8" COMP
Sharkbite Tee Stop. Simple installation for icemakers, humidifiers, dishwashers and more. Copper, CPVC, PEX to Compression fitting

23049 1/2" X 1/4" (3/8" OD)
23337 1/2" X 1/4" (comp)
23037 1/2" X 3/8" (comp)
Straight Stop
23036 1/2" X 3/8" (comp)
Angle Stop (Lead Free)

Drop Ear Elbow
U332 3/8" X 1/2" FNPT
U334 1/2" X 1/2" FNPT
U340 3/4" X 3/4" FNPT
Threaded

"Water Heater Flex Line"



U3088FLEX12 12" len.
U3088FLEX18 18" len.
U3088FLEX24 24" len.
The 3/4" X 3/4" FIP, stainless steel braided flexible hose and the rotatability of the SharkBite fitting



U3088FLEX18BV 18" len.
3/4" X 3/4" FIP, stainless steel braided flexible hose with ball valve.

End Stop
U512 3/8"
U514 1/2"
U518 3/4"
U520 1"

Reducing Coupling
U009 3/8" X 1/2"
U058 3/4" X 1/2"
U060 1" X 3/4"

U3523LF
Stop Valve Connector Converts 3/8" compression to Sharkbite 1/4" (3/8" OD) X 3/8" compression nut 1/4" X 9/16" - 24 UNEF Thread

U2276LF
1/4" X 3/4"
Garden hose nut dishwasher elbow, push on

2/PK

22604 1/2" X 3/4" FNTP
22441 3/4" X 3/4" FNTP
Hot Water Tank Install Kit, c/w 2 fittings and disconnect clip

24504 1/2"
Sharkbite
Thermostatic mixing valve, adj outlet temp 85-130°F (29-54°C)

22222-0000 1/2"
22185-0000 3/4"
22223-0000 1"
Full port ball valve now comes w/integral connectors for easy installation.



Sharkbite Eats the Competition

- Thicker walls
- Solid forged brass defends against chemicals
- Higher quality steel grab ring
- Meets lead-free initiative .24%

- Higher o-ring chloramine resistance
- Higher o-ring stress test score
- Certified to 200PSI and 200°F (93°C)
- Push fit onto copper, CPVC or Pex
- No soldering, clamps or tools required

Hoses

Toilet Supply



PART #	LEN.
70606	6"
55513	9"
55510	12"
55511	16"
55512	20"

Plastic ballcock nut, Chrome brass, compression nut

Sink Supply



PART #	LEN.
70206	6"
55503	9"
55500	12"
55501	16"
55502	20"
230-300	30"
70248	48"

Brass nuts, chrome plated

Extension



PART #	LEN.
55507	12"
55509	20"

Extension supplies, 3/8" X 3/8", Brass nuts, chrome plated

Extension



PART #	LEN.
70712	12"
70720	20"

Extension supplies, 3/8" O.D. COMP X 3/8" COMP, Brass nuts, chrome plated

Dishwasher Supply



3241-480	48"
3241-600	60"
3241-720	72"

Stainless steel braided dishwasher supply line. Comes complete with both old and new style elbow fittings



VI3460
3/4" x 3/8" elbow hose fitting for dishwasher installation.



70500
BRASS 90° 3/8" Comp x 3/8" MIP



228-600	60"
228-120	120"

Stainless steel braided ice-maker/humidifier supply lines. 1/4" comp. x 1/4" comp.

Install Kits

3270-001 12"
Toilet Installation Kit. Includes 12" stainless steel supply line, wax gasket with flange and closet bolts



3270-002 w/angle valves
3270-102 w/straight valves
Faucet Installation kit. Includes 2 ea 20" stainless steel supply lines, push-fit shut-off valves, push-fit removal tool (1), escutcheon plates & teflon (1), push-fit fits copper/CPVC and pex



3270-600 60"
3270-720 72"
Dishwasher Installation Kit. Includes 1 stainless steel supply line, ABS DW "Y", push-fit shut-off valve, 2 elbows, 3/8" MIP and 3/4" GDN hose, teflon and removal tool, push-fit fits copper/CPVC and pex



Icemaker Parts

3993-001
Icemaker/Humidifier installation kit. Includes 25' x 1/4" plastic tubing, saddle valve and fittings.



viega

New!



Proud supplier of Viega ProPress fittings

- Make secure connections in under 7 seconds!
- Smart Connect technology helps identify unpressed connections
- Available in sizes 1/2" to 4"
- Over 600 different fitting configurations!



Check out the Amre Website for 100's of in stock fittings and adapters! www.amresupply.com>plumbing>fittings



Check our website for a full selection of fittings in stock. www.amresupply.com



ULN342 3/8", 2/pkg
62R-106 5/8" X 3/8"
 Brass Compression Union, many other sizes available



ULN280 3/8" ferrules, 3/pkg
ULN281 3/8" nut
 C.P. Brass Compression hex nuts



ULN337 5/8" X 3/8"
 C.P. Brass Compression Union, pkg 2



65-6 3/8"
65-10 5/8"
 Brass Compression Elbows, many other sizes available



ULN282
ULN282B Split
 Chrome plated plates, 1/2" pipe, *other sizes available*



202873 1/2" Chrome
202873W 1/2" White
202874 3/4" Chrome
202874W 3/4" White
 Split flange, easy fit plastic, fits 1/2" or 3/4" copper



1101R
 Escutcheon with rubber inlet, Chrome with rubber center, 1/2"



1119
 Chrome plated, plastic sleeve, 1/2" split, 4/pk



121-04-04F-14WHA 2/pk
 Integral Water Hammer Arresters. Compact design, prevents banging pipes, Installs in seconds, Hose X Female Swivel Hose, Straight, Rough Brass. 2/pk



1102-043 1/2"
102-044 3/4"
 Sediment Faucet angle mount MIP threaded/Sweat



1102-003 1/2"
102-004 3/4"
 Brass Boiler Drains, Compression valve, MIP threaded/Sweat



1/4 Turn
1102-053 1/2"
1102-054 3/4"
 Brass Boiler Drains, 1/4 Turn, ball type, quarter turn, MIP threaded/Sweat

1/4 Turn



1103-053 1/2"
1103-054 3/4"
 Hose Bibb, 1/4 Turn, ball type, quarter turn MIP threaded/Sweat

New!

Easy-to-install push on Sharkbite connection to Copper, PEX, CPVC, or PE-RT!



24630LF 1/2"
24631LF 3/4"
 Sharkbite Hose Bibb, 1/4 Turn, 45deg. 3/4" MHT outlet



231640 1/2"
231661 3/4"
 High quality 25yr ltd warranty. Dahl Sediment Faucet. Angle Mount. MIP threaded/sweat.



9990 1/2"
9991 3/4"
 Dahl Stop repair stem and handle



121-04-04F
 3/4" Male Gdn x 3/4" Female Gdn Hosemate hose adapter shut-offs. Female ends have swivel for easy connection.



1108-904
 Brass hose bibb vacuum breaker

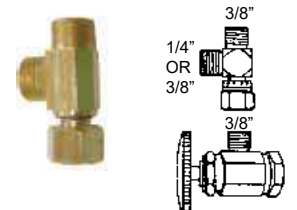

ULN299A 3/8" X 3/8"
ULN299 3/8" X 1/4"
 EZ-Connect Adapters, Makes Water appliance hook-up easy. Use when installing an icemaker, dishwasher.





Now Lead Free!



511-33-31
5/8" OD Comp X 3/8" OD Comp - 90°



Now Lead Free!



511-33-31
5/8" OD Comp x 3/8" OD Comp, Straight



Now Lead Free!



511-13-31
1/2" Solder by 3/8" Compression. Straight shut off.



Now Lead Free!



611-13-31
1/2" Solder by 3/8" Compression. Angle shut off.

Piggy Back



3325 90°
3326 Straight
Piggyback 3/8" x 3/8" female x compression retro-fit shut-off comp.



Now Lead Free!

Piggy Back



511-41-31
3/8" F Comp X 3/8" OD Comp Retrofit Dahl Mini-Ball Valve



Now Lead Free!

Piggy Back



611-41-31
3/8" F Comp X 3/8" OD Comp Retrofit Dahl Mini-Ball Valve



Now Lead Free!



23037 Straight
23036 Angle
1/2" X 3/8" comp, slip onto 1/2" pex, cpvc or copper



Now Lead Free!



Dual Outlet shut off
511-33-31-30
5/8" OD Comp x 3/8" OD Comp x 1/4" OD Comp, Icemaker
511-33-31-31
5/8" OD Comp x 3/8" OD Comp x 3/8" OD Comp, Dishwasher



Now Lead Free!



Straight
511-PX3-31 1/2" Pex x 3/8" Comp
511-PX3-30 1/2" Pex x 1/4" Comp
511-PX3-PX3 1/2" Pex x 1/2" Pex
Angle
611-PX3-31 1/2" Pex x 3/8" Comp



Now Lead Free!



511-31-31 3/8" Comp x 3/8" Comp (C.P.)
521-31-31 3/8" Comp x 3/8" Comp
521LB-33-33 5/8" Comp x 5/8" Comp (L. Bore)
521-31-30 3/8" Comp x 1/4" Comp
521-30-30 1/4" Comp x 1/4" Comp

UNIVERSAL ACCESS DOORS

Plastic Access Door



Part#	Door Size	Wall Opening
PA8X8	8" X 8"	8-3/8" X 8-3/8"
PA14X14	14" X 14"	14-3/8" X 14-3/8"

Access Doors Made from UV stabilized high-impact ABS, the textured panel surface can be painted, wallpapered or tiled to match any decor and are approved for indoor or outdoor use. Panels fasten on all four sides to prevent sagging
Panels can be flush or surface mounted

Metal Access Door



Part#	Door Size	Wall Opening
UA8X8	8" X 8"	8-3/8" X 8-3/8"
UA10X10	10" X 10"	10-3/8" X 10-3/8"
UA12X12	12" X 12"	12-3/8" X 12-3/8"
UA14X14	14" X 14"	14-3/8" X 14-3/8"
UA16X16	16" X 16"	16-3/8" X 16-3/8"
UA18X18	18" X 18"	18-3/8" X 18-3/8"
UA24X24	24" X 24"	24-3/8" X 24-3/8"
UA30X30	30" X 30"	30-3/8" X 30-3/8"

Access Doors Non-Rated Flush Door For Dry-wall, Masonry, & Tile, Door: 14 Gauge Steel (0.078 inch thick), Frame: 16 Gauge Steel (0.060 inch thick), 1" Wide Grey Prime Coat, Wall Opening: Allow additional 1/8" - 3/8" for rough wall opening

Insulated Fire Rated Access Door



Part#	Door Size	Wall Opening
MPFR88	8" X 8"	8-1/2" X 8-1/2"
361212	12" X 12"	12-1/2" X 12-1/2"
MPFR1818	18" X 18"	18-1/2" X 18-1/2"
MPFR2424	24" X 24"	24-1/2" X 24-1/2"

Access Doors The MIFAB® MPFR fire rated access door is approved by Underwriters Laboratories Inc., for 1 1/2 hours, "B" label in walls and is approved by Warnock Hersey for 2 hours in ceilings and 3 hours in walls. The door meets ANSI-UL 10B standards. The same door can be used in walls and ceilings. Tests were conducted using mild steel and type 304 stainless steel.



Part#	Door Size
APU9	9" X 9"
APU15	15" X 15"

Access Doors The Watts SpringFit Access Panel offers a convenient and attractive means to hide unsightly wires, cables and pumps while maintaining their accessibility. No cutting is required to fit the SpringFit Access Panel - white.



PREMIUM SERIES



FORGED BRASS BALL VALVE • FULL PORT • 600 PSI

Threaded (Female)

Part No.	Port Size	Size
1107-821	.315"	1/4"
1107-822	.394"	3/8"
1107-823	.590"	1/2"
1107-824	.787"	3/4"
1107-825	.984"	1"
1107-826	1.260"	1-1/4"
1107-827	1.575"	1-1/2"
1107-828	1.968"	2"

Solder

1197-503	.590"	1/2"
1107-844	.787"	3/4"
1107-845	.984"	1"
1107-846	1.260"	1-1/4"
1107-847	1.575"	1-1/2"
1107-848	1.968"	2"

BALL VALVE WITH DRAIN
500 psi Female Thread



Part No.	Size
1197-753	1/2"
1197-754	3/4"
1197-755	1"



BALL VALVE WITH DRAIN
500 psi c x c (solder)

Part No.	Size
1197-553	1/2"
1197-554	3/4"
1107-555	1"



BALL VALVE (WITH DRAIN)
comp x comp

Part No.	Size
1197-023	1/2"
1197-024	3/4"
1197-025	1"



9921 2-1/2" Deep
9922 3-3/8" Flat
Access partition plates



Replacement parts for 2300 series

9951 6" access key
109130 9" access key



BRONZE • IN LINE CHECK VALVE

- Rated at 200 PSI • Spring loaded bronze poppet
- Can be used horizontally or vertically
- Threads comply with ANSI B1.20.1

Threaded

Part No.	Size
1191-303	1/2"
1191-304	3/4"
1191-305	1"
1191-307	1-1/2"
1191-308	2"



FORGED BRASS • GAS BALL VALVE • ONE PIECE BODY

- AGA 3-88 (5PSIG) certified
- Chrome plated forged brass ball
- Threaded ends comply with ANSI B1.20.1

Lever Handle

Part No.	Type	Size
1110-523	AGA/UL/CGA	1/2"
1110-524	AGA/UL/CGA	3/4"



9992 1/2"

9994 3/4"

Stem assembly for 2300 series partition stops, excluding plate and key.



Partition Stops

Key Operated Straight

Part#	Size
2310-K12	1/2"C x 1/2"C
2310-K34	3/4"C x 3/4"C



ULN514

Lawn Faucet/Frost Free Hydrant Handle. Square Stem.



16 PT.

ULN517

Lawn Faucet/Frost Free Hydrant Handle. 16 broach round hole.



BRASS BALL VALVE • FULL PORT
PEX BARB 400 PSI

Part No.	Type	Size
1197-343	Barbed	1/2"
1197-344	Barbed	3/4"

New!

Easy-install
push connection
compatible with
Copper, PEX, CPVC,
or PE-RT!



24629LF 10"

24636LF 12"

Sharkbite Frost-Free Wall Hydrant.
1/2" push-fit inlet x 3/4" MHT outlet.
Multi-turn shut off. Anti-siphon

1/4 Turn



1104-555 8"

1104-557 10"

1104-559 12"

1104-561 14"

Quarter Turn Washerless Non-Freeze Hydrant, Anti Siphon. 1/2" Male Thread or 1/2" solder.



1395-100 10"

1395-120 12"

1395-140 14"

Non-Freeze Wall Hydrant. 1/2" Male Thread or 1/2" solder connection. **Note: No Anti Siphon**

Part Size

1392-080 8"

1392-100 10"

1392-120 12"

1392-140 14"

Non freeze wall hydrants – anti siphon, 1/2" Male Thread X 1/2" Solder



12 PT.



ULN514A

Lawn Faucet/Frost Free Hydrant Handle. 12 broach round hole.

ULN515

Lawn Faucet Loose Key For Square Stems. .325 Square.



Kitchen
Single Lever faucets



American Standard
Ceramic Disc



American Standard
New Pro Model Features



192-417 Chrome
B&K single lever kitchen faucet, washerless, 3 hole 8" install, c/w braided stainless steel connections - *Lead Free*

4205000.002 Chrome
AmStd Reliant kitchen faucet. Ceramic disc valve, 8" install, cast brass construction, metal handle, higher longer spout, 1/2" male thread inlets

7074000.002 Chrome
AmStd Colony Pro single lever kitchen faucet. 3 hole, 8" install, 24" colour coded s.s. flex lines, metal handle, Ceramic cartridge, 1.5gpm - *Lead Free*



10900LF Chrome
Delta Foundations Single Lever Kitchen Faucet
- 3-hole 8" installation, ADA Compliant
- 1/2" threaded male inlet connectors
- Standard spout swivels 360degrees
- 1.80 gpm (6.8 L/min), washerless



67425 no spray
67434 w/side spray
Moen "Chateau" chrome single lever kitchen faucet, washerless, 3 hole 8" install, c/w flexible 3/8" supply connections and 9-1/8" spout



P88200LF Chrome
Peerless single lever kitchen faucet, washerless, 3 hole 8" install, 1/2" threaded inlets, 9-1/2" spout - *Lead Free*

Kitchen
Two handle faucets



192-608 Chrome
B&K two handle kitchen faucet, acrylic handles, 3 hole, washerless - *Lead Free*



3065 Chrome
Belanger 8" swivel spout, 8" centers, 1/2" IPS connections, Brass waterways and ceramic cartridge



2381-216 Chrome
Emco Replacement two handle kitchen faucet, chrome plated metal handles, compression cartridge



77924 Chrome
Moen II Series, two handle kitchen faucet, small lever handles, washerless, Quick Connect



77925 Chrome
Moen II Series, two handle kitchen faucet, Quick Connect, chrome handles, washerless



82004LF Chrome, Washerless
Waltec two handle kitchen faucet, c/w chrome metal lever handles, 3 hole - *Lead Free*



25F641LF Compression
82006LF Washerless
Waltec two handle kitchen faucet, c/w chrome plated fluted handles, 3 hole, Chrome - *Lead Free*



25F643LF Compression
82009LF Washerless
Waltec two handle kitchen faucet, c/w chrome plated lever handles. 3 hole, Chrome (Spray models avail.) - *Lead Free*

Faucets

kitchen . residential . bar . pull out

Kitchen Pullout faucets



P188103LF Chrome
Peerless Pull-Down Kitchen Faucet
- 1 or 3 hole installation, ADA Compliant
- 1/2" threaded male inlet connectors
- 2 Function pull down sprayer
- 1.80 gpm (6.8 L/min), ceramic valve

American Standard
New Pro Model Features



4175300.002 Chrome
AmStd Colony Pro pull-down kitchen faucet.
1 or 3 hole install, 24" colour coded s.s. flex lines, ceramic cartridge, adjustable spray and pause, 2.2gpm - *Lead Free*

American Standard
New Pro Model Features



7074100.002 Chrome
AmStd Colony Pro pull-out kitchen faucet. 1 or 3 hole install, 24" colour coded s.s. flex lines, ceramic cartridge, adjustable spray, 1.5gpm - *Lead Free*



67315C Chrome
Moen Integra Pull-Out Kitchen Faucet. 1 or 3 hole mount, Duralock quick connect install system, ADA compliant, 1.5gpm, 3/8" flexible supplies



470-DST Chrome
Delta Signature Pull-Out Kitchen Faucet. 1 or 3 hole mount, 3/8" supply lines, Diamond Seal technology, ADA compliant, 1.8gpm



469LF Chrome
Delta Pull-Out Kitchen Faucet. 1 or 3 hole, 8" centers, washerless ball valve, stream or spray, integrated supply lines

Bar/Utility Two handle faucets



2125-503 Chrome
B&K two handle bar/prep faucet, metal handles, washerless, 4" centers, brass waterways, metal housing, 6" spout c/w aerator and threaded hose adapter



82904 Chrome
Waltec two handle bar/prep faucet, metal lever handles, 4" faucet w/hose end, flexible supply inlets, 6" swing spout



27W411LF Chrome
Waltec two handle bar/prep faucet, 6" spout, w/chrome handles, compression - *Lead Free*

24 HR.

Order by **4pm** for **24-48hr shipping** to almost anywhere in Canada!

Basket Strainers
pg. 162



Faucet Repair Parts
pg. 189



Don't forget
to login to see
wholesale pricing

www.amresupply.com



Bathroom
Single lever faucets



www.amresupply.com

Check out our full selection of faucets!

American Standard

Speed Connect Drain Saves Time!



7385000.002 Chrome AmStd Reliant 3 single lever lavatory faucet. 4" centers, braided flex supply hoses, metal lever handle, Speed connect pop up drain included

American Standard

New Pro Model Features



7075005.002 Chrome AmStd Colony Pro single lever lavatory faucet. 4" install, ceramic disc, 24" colour coded s.s. flex lines 1.2gpm, Pop-up sold separate. *Lead Free*

aqua-dynamic



2192-330 Chrome B&K single lever lavatory faucet, 4" centers, c/w braided steel connections, ceramic cartridge, washerless, and metal handle. *Pop-up sold separately - Lead Free*

MOEN



L64601 Less pop-up
L64621 w/pop-up
Moen "Chateau" Single Lever Lavatory Faucet, w/solid lever, chrome, 1/2" connections, washerless. 1.5gpm

PEERLESS



P88620LF Chrome
P88620LF-BN Brushed Nickel
Peerless single lever lavatory faucet, 4" centers, 2.2gpm, 1/2" threaded inlets *Plastic Pop-up included - Lead Free*

American Standard



7075104.002 Chrome AmStd Colony Pro single lever 1 hole mono-block lavatory faucet. Ceramic disc, 24" colour coded s.s. flex lines 1.2gpm, Pop-up sold separate. *- Lead Free*

MOEN



6190 Chrome Moen Align Single Lever Handle High-Arc Lavatory Faucet. Flexible supply lines with 3/8" compression fittings. Includes metal pop-up waste assembly, 1 or 3 hole. 1.2 gpm

PEERLESS



P188620LF Chrome Peerless Single Lever Lavatory Faucet - 3 Hole 4" Centerset, ADA Compliant - 1/2" threaded male inlet connectors - Pop-up drain assembly included - 1.5 gpm, washerless

P.O. Plugs & Drains
pg. 160

Supply Lines
pg. 173

ABS Fittings
pg. 167



online: www.amresupply.com, or call **1.800.661.9891**



Faucets

Bathroom
Two handle faucets

bathroom . residential . two handle

DELTA
FOUNTAIN



B2510LF-PPU Chrome
Delta Foundations 2 Handle
Lavatory Faucet
- 3 Hole 4" Centerset, ADA Compliant
- 1/2" threaded male inlet connectors
- Pop-up drain assembly included
- 1.2 gpm (4.5L/min), washerless

PEERLESS



P99628LF-W Chrome
Peerless 2 handle lav faucet, 1.5gpm, 3 hole
4" install, washerless, incl. *pop-up drain as-*
sembly. - **Lead Free**

MOEN

New!



74961 Chrome
Moen II, two handle lavatory faucet, with
clera actylic fluted handles, 4" centers,

aqua-dynamic



191-604 Chrome
B&K two handle lavatory faucet, acrylic handles,
1/4 turn washerless, 4" centers, metal housing
Pop-up sold separately - **Lead Free**

belonger



3063 Chrome
Belanger, 4" centers, 1/2" IPS connections,
Brass waterways. Faucet designed to accom-
modate a P.O. plug lift rod and compression
cartridge.



2381-210 Chrome
Emco Replacement two handle lavatory fau-
cet, metal handles, 4" centers, and compres-
sion cartridge. *Pop-up sold separately*

MOEN



74960 Chrome
Moen II, two handle lavatory faucet, with
chrome plated fluted handles, 4" centers,
washerless

MOEN



74962 Chrome
Moen II, two handle lavatory faucet, with
chrome plated lever handles, 4" centers,
washerless

WALTEC

**PRO
PICK**



21F141LF Compression
82231LF Washerless
Delta/Waltec two handle lavatory faucet, 4"
centerset, chrome plated fluted handles.
- **Lead Free.** *Pop-up sold separately*

WALTEC



21F143LF Compression
82339LF Washerless
Delta/Waltec, two handle lavatory faucet, 4" cent-
erset, chrome plated lever handles. *Pop-up sold*
separately - **Lead Free**

WALTEC

"metal lever
handles"



82234LF Chrome
Delta/waltec two handle lavatory faucet, 4"
centerset, with metal lever handles, washer-
less. *Pop-up sold separately* - **Lead Free**

24 HR.



Order by **4pm** for **24-48hr**
shipping to almost
anywhere in Canada!

DELTA
COMMERCIAL



healthcare . education . public facilities . hospitality

Why Delta? Delta offers innovative solutions with
excellent quality and value for your needs!





Rough-In

14F525 Chrome
Waltec Surface/facemount Tub & Shower Trim 6" Centers for 1/2" Connections, compression

14F501
Facemount Trim Kit, no showerhead/arm

14WF324
Rough-In Sold Separately



Rough-In sold sep.

14F625-1
Waltec tub/shower trim with hand shower. Rough-in sold separate 14WF324



Rough-In

14F115 Chrome
Waltec Tub & Shower Concealed trim and In Wall Diverter Only, Compression

14WF144
Rough-In Sold Separately



B114900 Chrome
Delta Foundations Single Lever Shower Faucet. Incl. R10000-UNBX universal rough-in assembly. Slip on tub spout. Pressure balanced, 2.0 gpm shower head

Colony Pro Series



Rough-In sold sep.



T075500.002 Handle Trim only
T075507.002 Shower Trim Kit
T075508.002 Shower/Tub Kit
R111 Rough-in
Colony Pro Tub/Shower Kits
Metal lever handle, easy clean shower head, red/blue indicator escutcheon, 1.75gpm, pressure balancing and safety stop, rough-in has universal inlet/outlets. Chrome

T13020

T13020-CDN Handle/Trim Only

T13220-CDN Handle/Trim & Shower Head

T13420-CDN Handle, Shower and Tub Spout Trim
Delta Classic pressure balanced tub and shower faucet. Chrome. Monitor 13 series mixing valve. Solid brass body. T13420 model comes with 1/2" slip-on spout. Rough-in Sold separate #R10000-UN or R10000-UNWS



T13220

T13420

R10000-UN

R10000-UN
R10000-UNWS w/stops
Delta multi-choice rough-in. 1/2" universal inlets/outlets. Solder or threaded for convenience. Model R10000-UNWS has screwdriver stops.

Posi Temp Chateau Series



Valve sold sep.

TL181 Lever Handle
Moen Chateau trim kit, no spout or showerhead, chrome, posi temp

Posi Temp



Valve sold sep.

TL183 Lever Handle
Moen Chateau trim kit, with showerhead, slip on spout, pull up diverter, chrome, posi temp



62320
Moen Posi Temp rough in valve. 1/2" sweat connections.
62370 w/stops



Moentrol Series
Adjustable volume & temperature



Valve sold sep.

TL170 Lever handle
Moen Moentrol trim builders kit with, Valve Trim Only, chrome

Moentrol Series



Valve sold sep.

TL172 Chrome
Moen Moentrol trim builders kit with lever handle, Tub/Shower Trim Only



63170
Moen Moentrol rough in valve with integral stops. 1/2" sweat connections



It's Easy with Remodeling Cover Plates

M1921 Chrome
Moen remodeling cover plate, allows you to convert 2 or 3 handle faucet to a one handle faucet Mstr. Dimensions: 12" X 10" X 16"





Commercial Faucets
Engineered to perform under tough conditions.



605XTMV1070

AmStd Thermostatic Mixing Valve. 20" S.S. flex hoses with 3/8" compression fittings, integral check valves, anti-scald protection.



American Standard PWRX
New
10year/480,000 cycle battery life options



- 6053205.002** 0.5gpm PWRX 10yr
- 6053202.002** 1.5gpm PWRX 10yr
- 6055205.002** 0.5gpm
- 6055202.002** 1.5gpm
- AmStd Innsbrook Battery Operated Commercial Lavatory Faucet.
- Adjustable sensor
- Lithium battery included
- Vandal resistant
- 15" Single inlet S.S. hose 3/8" comp
- **Mixing valve sold separate 605XTMV1070**
- Also avail in AC, Multi AC and hardwire



- 7053205.002** 0.5gpm PWRX 10yr
- 7053215.002** 1.5gpm PWRX 10yr
- 7055205.002** 0.5gpm
- 7055215.002** 1.5gpm
- AmStd Selectronic Battery Operated Commercial Lavatory Faucet
- Adjustable sensor
- Above deck mixing valve w/removable handle
- Dual water supply hot/cold
- Lithium battery included
- Vandal resistant
- 4" deck plate sold sep. 705P400.002
- Also avail in AC, multi AC and hardwire
- Also avail less mixing valve



- 6053165.002** 0.5gpm PWRX 10yr
- 6053163.002** 1.5gpm PWRX 10yr
- 6055165.002** 0.5gpm
- 6055163.002** 1.5gpm
- AmStd Selectronic Battery Operated Commercial Lavatory Faucet.
- 6" Gooseneck Spout (5" model also avail)
- Adjustable sensor
- Lithium battery included
- Vandal resistant
- 15" Single inlet S.S. hose 3/8" comp
- **Mixing valve sold separate 605XTMV1070**
- Also avail in AC, Multi AC and hardwire

available in PWRX 10yr Option



- Deck Mount**
- 2064155.002** 0.4gpm
- 2064153.002** 1.25gpm
- Wall Mount***
- T064355.002** 0.5gpm
- T064353.002** 1.5gpm
- Serin Proximity Battery Lavatory Faucet
- CR-P2 lithium battery incl. lasts approx 4yrs (200,000 uses)
- Self adj. hidden sensor w/safety timer
- Mixing valve sold separate 605XTMV1070
- Also avail in AC, Multi AC and Hardwire
- *Requires rough in R350 Sold Sep.



- 6053105.002** 0.5gpm PWRX 10yr
- 6053102.002** 1.5gpm PWRX 10yr
- 6055105.002** 0.5gpm
- 6055102.002** 1.5gpm
- AmStd Selectronic Battery Operated Commercial Lavatory Faucet.
- Single hole mount
- Adjustable sensor
- Lithium battery included
- Vandal resistant solid brass construction
- 15" single inlet S.S. hose 3/8" comp
- Mixing valve sold separate 605XTMV1070
- Also available in AC, Multi-AC and hardwire

FIAT



- 830AA000**
- Fiat Service Sink Faucet. Commercial duty chrome plated, 8" centers, vacuum breaker, integral stops, 3/4" hose thread on spout, pail hook, adju. wall brace.

Electronic Faucet



Electronic Lavatory Faucets

- 0.5 gpm vandal resistant aerator, 0.6 on DEMD-611LF
- DEMD-101/320/301 for one temp water or req. mixing valve sold sep
- DEMD-111/321/311/611 temp can be adjusted above deck w/side mixer
- Adj run time and sensor with optional remote 060967A
- Other accessories available



- DEMD-101LF** Mix valve required
- DEMD-111LF** w/side mixer*
- Delta battery operated single hole sensor faucet.
- Above deck solenoid and 9V battery incl.
- * shown



- DEMD-301LF** Mix valve required
- DEMD-311LF** w/side mixer*
- Delta battery operated single hole sensor faucet.
- 6 x AA batteries incl.
- 4" or 8" coverplate available separate
- * as shown



- DEMD-611LF**
- Delta battery operated single hole sensor faucet.
- 6 x AA batteries incl., ASSE1070
- 4" or 8" coverplate available separate
- New style above deck integral mixing valve
- All components fully contained within body

New!

Solar Powered!



- DEMD-320LF** Mix valve required
- DEMD-321LF** w/side mixer*
- Delta battery operated single hole sensor faucet.
- 4 x AA batteries incl.
- 4" or 8" coverplate available separate
- * as shown



H2Optics sensor faucets

Infrared H²Optics® electronic handwash technology
One of the most advanced sensing technology in the industry!



DELTA COMMERCIAL
Delta Commercial
Faucets come with 5
year warranty on most
installations.



1501T3470

591T1250 Battery 0.5 gpm
Delta Sensor Faucet. 4" Centers.

590LF-LGHGMHDF 1 Hole*
591LF-LGHGMHDF 4" Center
Delta Sensor Faucet.
- Battery operated, 4 x AA included
- 0.5gpm vandal resistant aerator
- * as shown

1501T3370 1 Hole
1501T3470 4"
1501T3570 8"
**Delta Electronic Basin Faucet with
Gooseneck Spout.**
- 1.5gpm/5.7lpm
- Single inlet, mixing valve required
- Battery Operated 4xC
- Adjustable H2Optics Sensor
- 6"Radius/12"H Spout

Cast brass body, Surface mounted control box.
Hardwire transformer sold separate, Battery versions supplied , w/4xC batteries. Adjustable
sensing range and timeout. *Mixing valve sold separately*



R2910-MIXLF
3/8" COMPRESSION
Delta mechanical mixing valve.
Lead Free



R3070-MIXLF
3/8" COMPRESSION
Delta Thermostatic mixing valve
for ASSE 1070 applications - 5.0
gpm (19 L/min) maximum flow rate
- integral check valves. **Lead Free**



27C4842
Delta Sink Faucet Deckmount 4"
deck LESS pop-up - CER-TECK®
ceramic structures. 102mm (4")
centers, two handle. Chrome.
Spout#: 8 - Gooseneck spout-4.5"
radius - 10.5" height



28T9
Delta Service Sink faucet, HD
cartridges, 8" center, with integral
stops, 8" rigid vacuum breaker
spout, top brace, cross handles,
chrome finish



1.5gpm Vandal Resistant Aerator

22C151 No Pop up hole 1.9L/M
22C101 No Pop up hole 5.7L/M
22C051 Pop up hole 1.9L/M
22C001 Pop up hole 5.7L/M
Delta TECK Commercial 4" centreset lavatory
faucet, cast brass body, vandal resistant lever
handle and outlet.
Does NOT include metal pop-up



1.5gpm Vandal Resistant Aerator

22C651 No Pop up hole 1.9L/M
22C601 No Pop up hole 5.7L/M
22C851 C/W Pop up 1.9L/M
22C801 C/W Pop up 5.7L/M
Delta TECK Commercial single hole lavatory
faucet. Cast brass body, Vandal resistant lever



1.5gpm Vandal Resistant Aerator

21C132 4" Hooded Blade Handle
21C133 3" Lever Handle
21C134 4" Blade Handle
Standard 1.5gpm Aerator
21C142 4" Hooded Blade Handle
21C143 3" Lever Handles
Delta TECK Commercial 4" Centreset lavatory
faucet. Cast brass body. Vandal resistant blade
handles. **No pop-up or pop-up hole**



8" Wallform Spout

26C3132 4" Hooded Blade Hdle*
26C3133 3" Lever Handle

8" Tubular Spout

26C3232 4" Hooded Blade Hdle*
26C3233 3" Lever Handle
Delta TECK Commercial Sink Faucet. 8" cen-
ters, heavy duty cast brass, metal hold downs,
CER-TECK ceramic cartridges, 1.5gpm vandal
resistant aerator. *shown



86T1153

Delta Teck Commercial 4" Lavatory Faucet. No
pop-up hole, ADA compliant, 0.5 gpm vandal
resistant outlet, factory set for 9-16 second
cycle at 50psi, metering slow close cartridges



87T104 Push Button

87T105 ADA Push Lever
Delta Teck Commercial Single Hole Faucet.
Metering slow close cartridge, vandal
resistant, total flow not to exceed 0.25gal
per activation





Commercial Faucets
 Providing superior performing products that exceed the end-users' needs, while delivering lower lifetime costs for today's facilities.









104451
 Moen Thermostatic mixing valve, with adj. temperature control cartridge, vandal resistant, 1/2" FNPT connections with 3/8" compression adapters.



104424
 Manual mechanical mixing valve, 3/8" compression, inline backchecks included

8230
 Moen M-DURA rough two-handle service sink faucet. Solid cast brass, 3/4" garden hose threaded spout, wall mounting bracket, vacuum breaker, 1/2" IPS connections, service stops, 1/4 turn ceramic disc cartridges.

8270 Chrome
 Moen M-DURA two-handle pantry faucet. Solid brass construction, 1/2" IPS connections, lever handles, 1/4 turn ceramic disc cartridges, ADA compliant, vandal resistant aerator and screws, 4" centers, 1.2gpm



8278 Chrome
 Moen M-DURA two-handle pantry faucet. Solid brass construction, 1/2" IPS connections, 4" blade handles, 1/4 turn ceramic disc cartridges, ADA compliant, vandal resistant aerator and screws, 4" centers, 1.2gpm



8287 Chrome
 Moen M-DURA two-handle kitchen faucet. Solid brass construction, 1/2" IPS connections, lever handles, 1/4 turn ceramic disc cartridges, ADA compliant, vandal resistant aerator and screws, 8" centers, 1.5gpm



8289
 Moen M-DURA two-handle kitchen faucet. Solid brass construction, 1/2" IPS connections, wrist blade handles, 1/4 turn ceramic disc cartridges, ADA compliant, vandal resistant screws, 8" centers, 1.5gpm



8215 2.2gpm No Drain
8215F15 1.5gpm No Drain
8219 2.2gpm w/Drain
 Moen M-Dura Commercial 4" Blade Handle Lav Faucet. ADA compliant, 1/4 turn, brass construction, 1/2" IPS connections, 4" centers, vandal resistant aerator, chrome.





8800 Chrome
 Moen M-Bition Commercial Single 4" Blade Handle Lav Faucet. 1.5gpm, ADA compliant, 1/4 turn, metal construction, 1/2" IPS connections, 4" centers, no drain included



8422 Chrome
 Moen M-Bition Commercial Single 4" Lever Lav Faucet. 1.2gpm, ADA compliant, metal construction, 1255 Duralast cartridge, 3/8" flex connections, 4" centers, no drain included.



8430 Chrome
 Moen M-BITION one-handle lavatory faucet. Solid brass construction, 1/2" IPS connections, 3" pivot lever handle, 1255 Duralast cartridge, ADA compliant, vandal resistant aerator, 1.2gpm

PRO PICK
8884 Chrome
 Moen M-PRESS one-handle metering faucet. Solid brass construction, 1/2" IPS connection, 1 hole mount, adj from 5 to 60sec, ADA compliant, vandal resistant, 0.5gpm, 52100 metering cartridge (Optional 4" deck plate available 99550) Drain and mixing valve sold separate



8886 Chrome
 Moen M-PRESS two-handle metering lavatory faucet. Solid brass construction, 1/2" IPS connections, adj from 5 to 60sec, ADA compliant, vandal resistant, 0.5gpm, 52100 metering cartridge, 4" centers.



8413 2.2gpm No Drain
8413F15 1.5gpm No Drain
8414 2.2gpm w/Drain
 Moen M-Dura Commercial Single Lever Lav Faucet. ADA compliant, Solid brass construction, ceramic cartridge, 1/2" IPS connections, 4" centers, chrome



8553 Non mixing, Battery
8553AC Non mixing w/AC Adpt.
8554 W/Mixing, Battery
8554AC W/Mixing w/AC Adpt.
 Moen M-Power Hands Free Lav Sensor Faucet. Single-mount, 4 AA included w/battery model, easy access, metal body, 3/8" connections, 0.5gpm vandal-resistant, Without drain. Deck plates avail. sep.



8551 Non mixing, Battery
8551AC Non mixing w/AC Adpt.
8552 W/Mixing, Battery
8552AC W/Mixing w/AC Adpt.
 Moen M-Power Hands Free Lav Sensor Faucet. Single-mount, 4 AA included w/battery model, easy access, metal body, 3/8" connections, 0.5gpm vandal-resistant, Without drain. Deck plates avail sep.



SLOAN®

Since 1906, Sloan has been the world's leading manufacturer of water-efficient solutions that are built to perform, guaranteed to last, and are designed with the hopes of promoting a healthy environment through water conservation.

SLOAN.

Mixing Valve Required



EBF-85-4 Battery Powered
ETF-80-4-LT 120V/24Vac
 Sensor Activated Electronic Hand Washing Faucet for tempered or hot/cold water operation. 0.5 gpm/1.9 Lpm Vandal Resistant Spray Head 4" Centers. Transformer sold separately for ETF80-4, order ETF-416 Plug-in or EL248-40 Box mount

SLOAN.

Mixing Valve Required



EBF-650 Battery Powered
ETF-600-LT 120V/24Vac
 Chrome Plated Brass, Sensor Activated, 4" Center-set Electronic Hand Washing Faucet for tempered or hot/cold water operation. 0.5 gpm/1.9 Lpm Vandal Resistant Spray Head Transformer sold separately for ETF-600-LT

SLOAN.

Mixing Valve Required



EBF-615-4 Battery Powered
ETF-610-4-LT 120V/24Vac
 Chrome Plated Brass, Sensor Activated, Pedestal Electronic Hand Washing Faucet for tempered or hot/cold water operation. 0.5 gpm/1.9 Lpm Vandal Resistant Spray Head Transformer sold separately for ETF-610-LT

SLOAN.

EAF-250-ISM



EAF-250 Non-Mixing
EAF-250-ISM W/Mixing
 Sloan Lino Battery Powered Sensor Faucet. 1pc construction, die-cast metal construction, 6v lithium CR-P2 battery included, 0.5gpm, double infrared sensor technology, single hole, deck plates avail. sep. Avail. in DC, EAF-200 series.

SLOAN.

Mixing Valve Required



SF-2100 6VDC w/battery backup
SF-2150 Battery Powered
 Sloan SF Series Sensor Pedestal Faucet Brass construction, 0.5gpm, 4 AA batteries included with battery model, Plug in adapter w/2100 model, adjustable sensor, c/w 4" plate kit, mixing valve sold sep. MIX-60-A

SLOAN.

Solar Powered



EAF-275 Non-Mixing
EAF-275-ISM W/Mixing
 Sloan Solis Solar Powered, Sensor Activated Faucet. Automatic Self-adapting Sensor Technology, Includes 6 VDC lithium backup battery, metal construction, w/supply, single hole mount, 0.5gpm, deck plates avail. sep.

SYMMONS



S-20-IPS-1.5 No Pop-up
S-20-2-IPS-1.5 With Pop-up
 Symmons Symmetrix® Single Handle Center-set Lavatory Faucet. 4" centers, Ceramic cartridge, 3/8" copper supply lines, lift rod hole 1.5 gpm, chrome

SYMMONS



S-23 3/8" copper lines
S-23-BH 3/8" braided lines
 Symmons Origins™ Single Handle Kitchen Faucet. 8" mount, Ceramic cartridge, 8 1/2" spout, 2.2 gpm (8.3 L/min) standard, Chrome

24 HR.



Order by
4pm for
24-48hr shipping
 to almost anywhere in Canada!



**AMRE is now an authorized stocking
 Dyson Hand Dryer Distributor.**

dyson airblade

Call us today for more information or to book on
 on-site demo or consultation

www.amresupply.com



TOTO®

improves many designs with our commitment to innovation and improving functionality.

TOTO New Toto models Spout and Controllers are now sold separate.

1. Choose Spout
2. Choose Matching Flow Controller 0.5 or 1.0gpm
3. Add mixing valve or deckplate if required



Toto HydroPower Commercial Faucets

- Self-generating hydropowered EcoPower system
- Self charging battery
- No minimum daily usage requirement
- Micro-sensor positioned under spout and consistent water distribution
- Vandal resistant, Chrome plated

Spouts

- TELS155#CP** Gooseneck 0.5gpm
- TELS151#CP** Gooseneck 1.0gpm
- TELS105#CP** Standard 0.5gpm
- TELS101#CP** Standard 1.0gpm
- TELS145#CP** Axiom 0.5gpm
- TELS141#CP** Axiom 1.0gpm
- TELS115#CP** Helix 0.5gpm
- TELS111#CP** Helix 1.0gpm
- TELS135#CP** Helix Wall 0.5gpm
- TELS131#CP** Helix Wall 1.0gpm



Controllers

- TELC105-D10E** 0.5gpm Controller
- TELC101-D10E** 1.0gpm Controller

Accessories

- THP3158#CP** 4" Deckplate
- 71244T8CC** 8" Deckplate
- TLM10** Mixing Valve
- TLT10** Thermostatic Mixing Valve

Universal Mixing Valves

Honeywell



- AM100C1070-UT-1LF** 1/2"
 - AM101C-US-1LF** 3/4"
- Honeywell Thermostatic Mixing Valve. Threaded unions, internal check valve, tamper resistant, 80-120F temp range, Operates with flow rates as low as 0.5gpm

WATTS



- 0204143** (USG-B) 3/8" COMPRESSION
- Watts thermostatic mixing valves maintain and limit hot water to desired select able temperature between 80°F and 120°F (27°C and 49°C) with flow rates as low as 0.5 gpm (1.9 lpm) and as high as 2.5 gpm (9.5 lpm). - *Lead Free*

WATTS



- 0559115** (MMV-US-1/2) 1/2" SOLDER
 - 0559118** (MMV-US-3/4) 3/4" SOLDER
- Watts MMV Thermostatic Mixing Valves maintain and limit mixed hot water to a desired, selectable temperature. The MMV series can be set to any temperature between 80°F and 120°F (27°C and 49°C) with flow rates as low as 0.5 gpm and as high as 12 gpm.



- 24504** 1/2" Sharkbite
- Thermostatic mixing valve, adj outlet temp 85-130°F (29-54°C)

TOTO®

AMRE SUPPLY

Property Performance Centres

Authorized Toto Parts Distributor

Repair parts available for all **Toto residential and commercial faucets!**





Zurn Engineered Water Solutions® is a recognized leader in commercial, municipal, and industrial markets. Zurn manufactures the largest breadth of engineered water solutions in the industry, including a wide spectrum of sustainable plumbing products.



Z6930-XL
AquaSense Flow Rate: 1.5 gpm Vandal Resistant Aerator Spout module: Chrome Plated Cast Brass
Includes:
In-line filter / 4 "AA" batteries / Inlet for a 1/2"[13] ball riser / Single supply hose



Z6915-XL
AquaSense Flow Rate: 1.5 gpm Vandal Resistant Aerator Spout module: Chrome Plated Cast Brass
Includes:
In-line filter / 4 "AA" batteries / Inlet for a 1/2"[13] ball riser / Single supply hose



Z6913-XL
AquaSense Flow Rate: 1.5 gpm Vandal Resistant Aerator Spout module: Chrome Plated Cast Brass
Includes:
In-line filter / 4 "AA" batteries / Inlet for a 1/2"[13] ball riser / Single supply hose

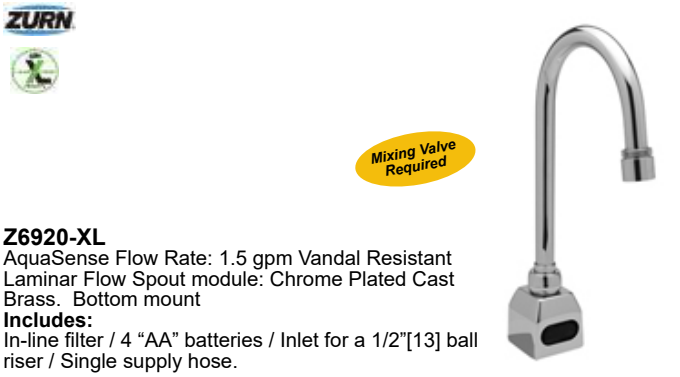

Z6920-XL
AquaSense Flow Rate: 1.5 gpm Vandal Resistant Laminar Flow Spout module: Chrome Plated Cast Brass. Bottom mount
Includes:
In-line filter / 4 "AA" batteries / Inlet for a 1/2"[13] ball riser / Single supply hose.



Z6950-XL-S
Zurn Aqua-Fit Series provide customizable settings for Time-out, Line Purge, Sensor Range, Metering Mode Infrared proximity sensor, 1.5 gpm Vandal Resistant Aerator, Chrome Plated Cast Brass, In-line filter / 4 "AA" batteries / Inlet for a 1/2"[13] ball riser / Single supply hose



Z6950-XL-IM-S
Zurn Aqua-Fit Series provide customizable settings for Time-out, Line Purge, Sensor Range, Metering Mode Infrared proximity sensor, 1.5 gpm Vandal Resistant Aerator, Chrome Plated Cast Brass, In-line filter / 4 "AA" batteries / Inlet for a 1/2"[13] ball riser / Single supply hose, integrated above deck mixing



Z6955-XL-S
Zurn Aqua-Fit Series provide customizable settings for Time-out, Line Purge, Sensor Range, Metering Mode Infrared proximity sensor, 1.5 gpm Vandal Resistant Aerator, Chrome Plated Cast Brass, In-line filter / 4 "AA" batteries / Inlet for a 1/2"[13] ball riser / Single supply hose, 4" centers.

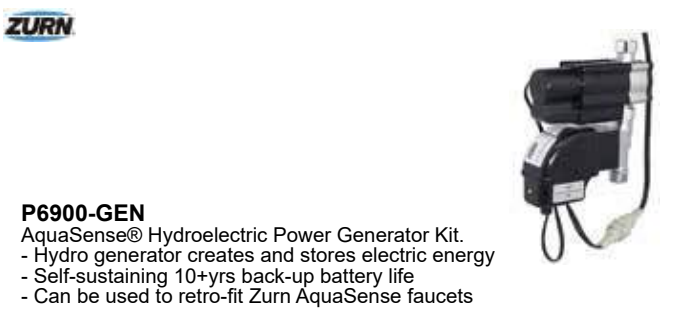

P6900-GEN
AquaSense® Hydroelectric Power Generator Kit.
- Hydro generator creates and stores electric energy
- Self-sustaining 10+yrs back-up battery life
- Can be used to retro-fit Zurn AquaSense faucets



P-6900-MV
AquaSense 3/8" COMPRESSION
Zurn Mechanical Valve, Mixing, Connection 3/8 MNPT In, Material of Construction Brass, Height 1 1/2 In, Width 3 In, Length 2 1/2 In, Operation 12V, For Use With Zurn Sensor Faucets, Includes Back Checks and Filter

SPRING ACTION GOOSENECK



B-0113
B-0113-B w/bracket
4" center deck faucet,
Stainless steel 44" hose
with spring



B-0133
B-0133-B w/bracket
8" center wall mount
faucet, 1/2" IPS female
eccentric flanged inlets
(00AA), 34" (863mm)
high



- B-0020-H** 20"
- B-0036-H** 36"
- B-0044-H** 44"
- B-0060-H** 60"
- B-0068-H** 68"
- B-0096-H** 96"

T&S Pre-rinse replacement flexible stainless steel hose, Polyurethane inner tubing, used on units with spring action gooseneck



- B-0107** Reg. Flow
 - B-0107-C** Low Flow
- T&S Pre-rinse spray valve, connects directly to T&S flexible stainless steel hose or Roto-Flex handle assembly, industrial kitchens, high pressure spray
- B-0108** Low Flow B-0113 series, 1.48gpm



B-0108



B-0665-BSTR
T&S Service sink faucet, built-in screwdriver stops, 8" centers, 2-3/8" clearance from the wall to center of faucet, polished chrome plated finish, vacuum breaker with 3/4" garden hose thread and pail hook and top support wall brace.

FAUCETS/SPOUTS SOLD SEPARATELY

Wall Mount



B-1115-LN 4"
T&S Splash back mounted, bronze body, removable seats, 4" centers, 6-1/2" x 2" wide chrome plated escutcheon, 1-1/2" long shanks and 1/2" IPS thread, spout separate

Wall Mount



B-1125-LN 8"
Splash Back Mounted, Bronze body, removable seats, 10-1/2" long X 2" wide chrome plated escutcheon, 8" centers, 1-1/2" long shanks, 1/2" IPS thread

Deck Mount



B-1100-LN 3-1/2"
B-1110-LN 4"
T&S Workboard Faucet, deck mounted, bronze body, removable seats, 6-1/2" x 2" wide chrome plated escutcheon, 4" centers, 1-1/2" long shanks & 1/2" IPS thread, spout separate

Deck Mount

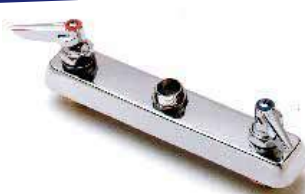

B-1120-LN 8"
Deck mounted, Bronze body, removable seats, 10-1/2" long X 2" wide chrome plated escutcheon, 8" centers, 1-1/2" long shanks, 1/2" IPS thread

Wall Mount



B-0230-LN
Swivel Nozzle Base
Swivel base faucet, wall mounted mixing faucet, lever handles, 8" centers & 1/2" IPS eccentric flanged female inlets, does not come with spout

Spout Assemblies for listed faucets



Part#	Length	Rise
059X	6"	2"
060X	8"	2-1/4"
061X	10"	3"
062X	12"	3-3/4"
063X	14"	4-1/4"
064X	16"	5"
065X	18"	5-3/4"

Swing Nozzles



























133X
T&S Swivel Gooseneck,
Spread 5-11/16" (144mm),
Height 8-3/4" (222mm),
Deck - tip of outlet 4-1/2" (114mm)

ADD ON FAUCETS & NOZZLES



B-0155 6" Nozzle
B-0156 12" Nozzle
B-0157 18" Nozzle
Add on faucet for pre-rinse units, adds swinging nozzle to pre-rinse units, 3" nipples included
Note: increases the height of a pre-rinse unit by approx. 4-1/2" any length nozzle furnished upon request - single or double jointed



<p>Aerators</p>  <p>ULN401 2.0gpm Aerator Economy female thread, non slotted aerator. 55/64°F each</p>	<p>Premium</p>  <p>ULN400 Aerator Premium dual thread adapter 15/16" M - 55/64" F - 27 TPI, each</p>	 <p>2130T 2.0gpm Aerator Economy non slotted male thread aerator, 13/16" M each</p>	 <p>ULN310 2.0gpm Aerator OEM quality non slotted male thread aerator, 13/16" M each</p>
<p>Premium</p>  <p>15P 1.5GPM 38D 2.2GPM Aerator premium dual thread premium slotted aerator with 3 screens for reduced splashing. 15/16" M and 55/64" F threads. Each</p>	 <p>2124T 2.0gpm Aerator dual thread 15/16" M 55/64" F, Economy, each</p>	 <p>2002B white 2002A chrome/white Aerator Double jointed swivel aerators c/w adapters, dual thread to fit almost any faucet, each</p>	<p><i>American Standard</i></p>  <p>060366-0070A American Standard kitchen spout seal kit. Fits Reliant models</p>
<p><i>American Standard</i></p>  <p>A951470-0070A American Standard Colony single lever cartridge. Kitchen & lavatory.</p>	<p><i>American Standard</i></p>  <p>023529-0070A American Standard single lever cartridge for Ceramix, Eletromix, Aquarian Reliant and more kitchen, lav & t/s</p>	<p><i>American Standard</i></p>  <p>994053-0070A American Standard ceramic disc cartridge</p>	<p><i>American Standard</i></p>  <p>A954440-0070A American Standard single lever ceramic disc cartridge</p>
<p><i>American Standard</i></p>  <p>ULNAS1 Hot (LH) ULNAS9 Cold (RH) ULNAS3 Seat American Standard Heritage Aquaseal cartridge. (G-72950-017/Q-00862-14)</p>	<p><i>Aquadis</i></p>  <p>ULNAD1 Hot ULNAD2 Cold Aquadis 1/2" washerless cartridge for 4" lav faucets (RP-B042HOT/RP-B042COLD)</p>	<p><i>Aquadis</i></p>  <p>ULNAD3 Hot ULNAD4 Cold Aquadis 1/2" ceramic disc cartridge for 8" widespread and tub fillers (RP-BA12HOT/RP-BA12COLD)</p>	<p><i>Aquadis</i></p>  <p>ULNAD5 Hot ULNAD6 Cold Aquadis 3/8" ceramic disc cartridge for 4" lav faucets (RP-BA38HOT/RP-BA38COLD)</p>
<p><i>Aquadis</i></p>  <p>ULNAD7 Aquadis replacement pressure balance cartridge with volume control. (OEM RP-D010)</p>	<p><i>Aquadis</i></p>  <p>ULNAD10 Aquadis replacement cartridge for single handle kitchen pull-out/pull-down faucets (RP-CB009B)</p>	<p><i>Aquadynamic</i></p> <p>B&K</p>  <p>888-703 B&K/Taymor/Aquadynamic washerless cartridge. 1/4 turn. Fits many 2 handle lav and kitchen faucets. May fit other brands also.</p>	<p><i>Aquadynamic</i></p> <p>B&K</p>  <p>888-708 Hot 888-709 Cold B&K/Taymor/Aquadynamic Handle. Fits many lav and kitchen 2 handle washerless 1/4 turn faucets. May fit other brands. D shaft.</p>
<p><i>Aquadynamic</i></p> <p>B&K</p>  <p>888-711 Hot 888-712 Cold B&K/Taymor/Aquadynamic handle insert. Fits lav and kitchen 2 handle washerless 1/4 turn faucets.</p>	<p><i>Aquadynamic</i></p>  <p>ULND9 (RP4993) Delta/ Aquadynamic Washerless faucet seats. Fit many brands such as Taymor, B&K etc...</p>	<p><i>CHICAGO FAUCETS</i></p>  <p>1-099XKJKNF Right 1-100XKJKNF Left Ceramic 1/4 Turn Operating Cartridge. Short Stem for Exposed Caps</p>	<p><i>CHICAGO FAUCETS</i></p>  <p>377-XKRHJKNF Right 377-XKLHJKNF Left Ceramic 1/4 Turn Operating Cartridge. Long Stem for Concealed Caps</p>





- FC9AC007
- FC9AC010
- FC9AC008
- FC9AC008C
- FC9AC005 Old Style
- FC9AC006 New Style



Belanger single lever Tub/Shower faucet. Ceramic cartridges



1-7/8"



FC9C2LH L.H. Hot
FC9C2RH R.H. Cold
Belanger Lavatory, Tub/Shower,
Kitchen compression faucet cartridge



FC9K2LH Cold
FC9K2RH Hot
Belanger Two Handle Ceramic
cartridges



FC94680-6
Belanger Faucet Pressure Balance
Piston. For use with single lever
faucets.



FC905075BR
Belanger handle with H/C indexes



ULN140 (FC05053BR)
Belanger/Cuthbert Acrylic clear handle,
includes hot & cold index buttons.



FC94000CPS
Belanger looped tub/shower handle.
Chrome



S65-001A
Bradley Foot Valve Repair Kit. Old Style.
Includes rear cap assembly, o-ring, dia-
phragm, seat, and seat removal tool.



S65-230
Bradley Foot Valve Repair Kit. 2003+
Newer. Includes rear cap assembly,
spring, plunger, 2x o-rings, diaphragm,
seat, and seat removal tool.



S45-050
Bradley Stop Strainer & Check Valve Repair
Kit. Includes strainer, spring, washer, o-ring,
and check valve.



ULNCU2K
Cuthbert Diverter with ULNCU2A. knob Non O.E.M. 91268-41



1-7/8"



ULNCU1
Cuthbert Cartridge Assembly For
All New Style Faucets
(Fits All Models Both Hot & Cold)
Fits Belanger CII



5/8"

3/8"



ULNCU10 9/16 X 24 TPI
Cuthbert Brass Renewable
Faucet Seat, Fits All New Models
& Most Old Style Tub & Showers
Lavatory Combinations & Deck
Faucets O.E.M. 9-0057A (1 Per Pack)



ULNCU2KL
Cuthbert Diverter Non O.E.M. 91268-41 with ULNCU2B knob Faucets O.E.M.
9-0057A (1 Per Pack)



ULNCU2BK
Cuthbert Diverter. Non O.E.M. 3360-7A Faucets O.E.M. 9-0057A (1 Per Pack)



5/8"

3/8"



ULNCU11 1/2 X 20 TPI
Cuthbert Renewable Faucet Seat,
Fits Old Style 4" Center Sets
Single Lavatory Faucets & Side
Handle Sink Fittings O.E.M. 0054
(1 Per Pack)



ULN139
Cuthbert C.P. Generic Metal Nova
Handle (Fits Belanger) 1 Handle,
2 Buttons 1 Screw/pkg/Bulk Non
O.E.M.



ULNCU4
Cuthbert Diverter Assembly With. Bonnet For Tub And Showers. (Built In Models)
Fits Belanger. 9-19605A Faucets O.E.M. 9-0057A (1 Per Pack)



ULNCU12
Cuthbert/Belanger tall faucet seats. 9/16"x24TPI.
For older Nova tub/shower models. 2/pk



Stems . Cartridges . Seats

DELTA

Note: Handle Stem

2"

ULND4A
Delta Faucet Single Acrylic Handle S.S. Ball Assm. O.E.M. RP212

DELTA

Note: Handle Stem

1-7/8"

ULND2A
Delta Faucet Single Lever S.S. Ball Assm. O.E.M. RP70

DELTA

ULND12
Delta Repair Kit For Single Lever Handle Faucets O.E.M. RP3614. Fits both crystal & lever handles

DELTA

ULND9
Delta Seat & Spring Assembly For Faucets (4 Pc. Pkg.) 2 Sets O.E.M. RP4993, 80196113, 80196114

DELTA

RP8230
Ceramic stem unit, seat with O-ring and spring for two handle faucets

DELTA

RP24096
Delta Stem unit assembly with brass stem and stainless steel plate

DELTA

RP25513
Delta HDF Stem Unit Assembly Replacement part c/w insert

DELTA

2"

ULND1
Delta/Delex Cartridge For Two Handle Lavatory/Kitchen, Tub & Shower Faucets. O.E.M. RP1740

DELTA

ULND20
Delta Tub & Shower Diverter O.E.M. RP2650

DELTA

RP18627
Extender with wrench and screw

DELTA

RP5649
Push button diverter assembly for single handle tub and shower faucets

DELTA

RP50587
Delta Single Lever Cartridge with Diamond Seal Technology.

DELTA

Best Sellers

ULND21 (RP19804)
Delta Single Lever Tub/Shower. Pressure Balance Cartridge, Assm. Sep. Models: 1300/1400, Series 2006 and older.

DELTA

RP46074
Delta Single Lever Tub/Shower Pressure Balance Cartridge Assembly, 1300/1400 series 2006 and later

DELTA

RP46463
Delta MultiChoice 17 Series Single Lever Cartridge With Adapter. Pressure Balanced. For Use With 17 Series Tub & Shower Faucets.

DELTA

RP32104
Cartridge assembly for 1500/1700 monitor series

DELTA

ULND13
Delta Single Lever Tub/Shower Scald Guard Stem Unit O.E.M. RP1991 Models: 1600

DELTA

ULND30
Delta Single Hole Ceramic Cartridge

DELTA

DELTA COMMERCIAL

063000A RH
063001A LH
Delta Cer-Tek ceramic disc cartridge

DELTA

DELTA COMMERCIAL

Now Lead Free!

ULNCB1X (OEM 063102A) Hot
ULNCB2X (OEM 063101A) Cold
Cambridge Brass Tek Cartridges

DELTA

ULN906
Cambridge Brass/Tempus Metering Unit Repl - Single Metering Faucet For Models w/Push Button O.E.M. 190009A. Kit incl: Set screw, button, allen screw & metering unit

DELTA

Now Lead Free!

ULNCB3X LH
ULNCB4X RH
Delta Cambridge Brass Cartridge with faucet & tub/shower seats. C.P. brass.

DELTA

RP574
Balance spool assembly

DELTA

061233A
Cambridge Brass/Tempus Metering Unit Replacement For Single and 4" Centerset Faucets

Knobs Single Handle

DELTA



ULN167B
Delta Single Lever Acrylic Handle For Lavatory Old Style O.E.M. RP2389

DELTA



ULN167C
Delta Single Lever Acrylic Handle For Tub & Shower With Index Button & Screw O.E.M. RP2391

DELTA



RP2390
Delta/Delex Acrylic Handle for Lavatory/ Kitchen/Tub & Shower Only O.E.M.

DELTA



ULN166A
Delta Acrylic Scald-Guard Handle For Tub & Shower With Index Button & Screw O.E.M. RP2392

DELTA



ULN167
Delta Single Lever C.P. Kitchen Handle With Set Screw O.E.M. RP2393

DELTA



RP17443
Delta Single Lever Kitchen Handle. With set screw. Chrome

DELTA



ULN167G
Delta Single Lever Acrylic Handle For Tub & Shower With Index Button & Screw O.E.M. RP17451

DELTA



ULN167P
Delta Monitor Acrylic Bath Handle With Button & Screw, for Scaldguard O.E.M. RP17655

DELTA



RP152
Delta set screw for single lever handle. Chrome

DELTA



H79 Metal
H71 Acrylic
Delta handle. For 1300/1400 series faucets. Tub/shower

Knobs Two Handle



ULN165
Delta Acrylic Older Style Handle For 2 Handle Lavatory/Kitchen/Tub & Shower Faucets With Index Button & Screw (1Pair/Pkg.) O.E.M. RP5693/RP19660/H21

DELTA



ULN164
Delta C.P. Plastic Handle Lavatory & Kitchen Faucets With Index Button & Screw (1 Pair/pkg.) O.E.M. RP6062/H28

WALTEC



ULN163
Waltec Flotrol C.P. Dome Handle With Index Button & Screw O.E.M. 76540 (1997-1994)
1 Handle, 2 Index Buttons, 1 Screw per pkg.

WALTEC



ULN155 Compression
ULN156 Washerless
Waltec C.P. Plastic Lever Handles, New Style 2-Handles, 2-Buttons, (Q151C, Q151H) 2-Screws (Q163E) per Pkg./Bulk Pair O.E.M. 76920. O.E.M. 76923 (1995 to date)

WALTEC



ULN151 Compression
ULN152 Washerless
Waltec C.P. Plastic Crown Handles. New Style 2-Handles, 2-Buttons, (Q151C, Q151H) 2-Screws (Q163E) per Pkg./Bulk Pair O.E.M. 76918, 76921.

WALTEC



ULN162A
Waltec C.P. Deck Handle For Flotrol with Index Button & Screw O.E.M. 76570 (1997-1994) Knob 1 Handle, 2 Index Buttons, 1 Screw per pkg.

Don't forget to login to see wholesale pricing

www.amresupply.com

WALTEC



ULN151C Cold O.E.M. 200364
ULN151H Hot O.E.M. 200363
Waltec Index Button-For ULN151/152/155/156

DELTA



RP5883 Chrome
Delta escutcheon plate. Fits 600 series. Screws sold separate RP196

DELTA



RP19809 Chrome
Delta escutcheon plate. Fits 1300 and 1400 series. Screws sold separate RP196

WALTEC



ULN162AA
Waltec Handle Insert O.E.M. 17514

WALTEC



ULN13X
Waltec Long. Brass. Renewable Seats. Tub & Showers &. Auto Wash - 9/16" - 24 TPI. O.E.M. 16392.
Meets lead-free initiative

WALTEC



ULN12X Chrome OEM
ULN12K Brass
Waltec/Wallaceburg Seats Faucets. 9/16" - 24 TPI O.E.M. 16500.
OEM Meets lead-free initiative

WALTEC



ULN15
Waltec Cartridge Repair Kit. Contains: 2 Seats, 2 Screws, 2 Washers, 2 O-Rings, and 2 Fibre Gaskets.

Stems

WALTEC



945 Hot
946 Cold
Waltec Pioneer Cartridges. Old Style, self seating. Tip: Can also be replaced with ULN20/21 with ULN12 seat.

WALTEC



ULN1K RH (Hot)
Non O.E.M. 76100
ULN2K LH (Cold)
Non O.E.M. 76101 Waltec Cartridge For All Faucets Prior to 1995

WALTEC



Hot R.H.
ULN20X OEM 96100
ULN20K Non OEM
Cold L.H.
ULN21X OEM 96101
ULN21K Non OEM
Waltec Cartridge. 1995 and newer.
Note: Will also replace old style ULN1K and 2K - X=Lead Free

WALTEC



ULN7
Waltec Complete Diverter Assembly For Starburst & Flotrol Facemount Tub & Showers (1970-73) O.E.M. 76305

WALTEC



ULN8
Waltec Diverter Assembly For Starburst & Flotrol Facemount Tub & Showers (1974-78) O.E.M. 76341

WALTEC



ULN184 (76363)
Waltec 8" Highrise Wallform Deck Spout w/aerator. Older Style

WALTEC



ULN184A (76541-1)
Waltec 8" Highrise Wallform Deck Spout w/aerator. With Nylon white D-Ring. Newer Style

Diverter Knobs

WALTEC



ULN163A
Waltec C.P. Threaded ABS Diverter Knob For Tub & Shower O.E.M. 10455

WALTEC



ULN163B
Waltec C.P. Brass Knob Diverter with Set Screw O.E.M. T4234-18030

WALTEC



ULN163F
Waltec Push/Pull Diverter Knob For Faucet Tub & Shower Starburst & Flotrol (Old Style) O.E.M. 76345

WALTEC



ULN163N
Waltec Push/Pull Diverter Knob For Faucet Tub & Shower Starburst & Flotrol (New Style) O.E.M. 76345 c/w screw

WALTEC



ULN10
Waltec Diverter Assembly For Flotrol Concealed Tub & Showers (1970-73) O.E.M. T25168

WALTEC



Popular o-ring for kitchen deck spouts
ULN724
25 Pc. "O" - Ring kit. Cuthbert/Emco/ Galt/Jameco/Sterling/Wallaceburg/ Waltec. 9/16" X 3/4" X 3/32"

WALTEC



ULN11
Waltec Diverter Assembly For Starburst & Flotrol Concealed Tub & Showers (Since 1974) O.E.M. 76655

WALTEC



ULN184B
Waltec Nylon Spout Split. Ring For New Style. Spout O.E.M. 16790

 MADE IN CANADA : QUALITY Replacement Part

Finding Parts Just Got Easier
www.amresupply.com Check out our new faucet model parts breakdowns

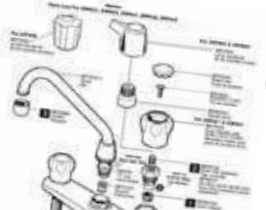

Emco



12 PT.

1-3/4"



ULNE1 O.E.M.
ULNE1K Non O.E.M.
 Emco cartridge, Emco Approved,
 OEM 1057. Fits Hot & Cold

Emco



12 PT.

1-7/8"



ULNE25X
 Emco Cartridge Fits Hot or Cold
 For Old or New Style Faucets
 O.E.M. 1057N - X=Lead Free

Emco



ULNE3A RH
ULNE3B LH
 Emco Cartridge For Use With. Blade
 Handles O.E.M. 1556, Heavy Duty

Emco



1-5/8"

ULNE4X
 Emco Cartridge For 4093
 Laundry Faucet Fits Hot or Cold
 O.E.M. 54-195223/4157 - X=Lead Free

Emco



5/8"

3/8"



ULNE13X
 Chrome plated, lead free
 OEM 51-137169
ULNE13K
 Brass Non OEM
 Emco renewable faucet seats
 9/16" x 27TPI

Emco



ULNE14 OEM 2/pkg
ULNE14K Non OEM
 Brass Renewable. Seats for Emco. Tub
 & Showers. Size 9/16" - 27 TPI. O.E.M.
 51-137719

Emco



ULNE12 3-1/4"
 Emco Diverter Stem Assembly
 For Facemount Tub & Shower
 NON O.E.M. 51-193210
 (Use with ULN126B Knob)

Emco



ULNE12A 3-3/4"
 Emco Diverter Cartridge for
 Facemount
 O.E.M. 2285/51-193782
 (Comes with ULN126C Knob)

Emco



ULNE11
 Emco Diverter Structure with Knob
 For. Concealed Tub and Shower.
 O.E.M. 51-193209/2275. (Comes with
 ULN126A Knob)

Emco



ULN126B
 Emco diverter knob. OEM 51-19243

Emco



ULN123B A = 1-1/2"
ULN124 A = 1-3/4"
 Emco Corona Handles. Sold in Pairs

Emco

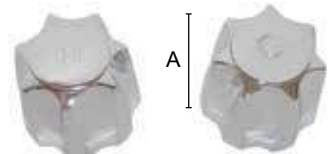

ULN5161 A = 1-1/2"
ULN5162 A = 1-3/4"
 Emco Corona Metal C.P. Handles
 With Index Button & Screw Sold in
 Pairs

Emco



ULN127

ULN127A

ULN127
ULN127A
 Emco Handle Inserts. (25 per Pkg.)

Emco



ULN168B Blue
ULN168C Red
 Emco Laundry Faucet Handle. Incl.
 handle, screw and insert.

Emco



ULN173
 Emco 8" Tubular C.P. Spout With
 Aerator For. Doric Corona & Classic
 Brass Cover Deck. Faucets O.E.M.
 90132/51-193105

Encore



KN13-0010
 Encore KN11/13 repair kit

Encore



KN50-Y006-CCV Cold (RH)
KN50-Y007-CCV Hot (LH)
 Encore valve assembly, ceramic, long
 barrel. K77/KN 50/60/80

Encore



KL50-Y006 Cold
KL50-Y007 Hot
 Encore cartridge assembly, long barrel
 for 8" center faucets, fits most K77/
 KN50/60/80 series

Encore



KL41-Y006 Cold
KL41-Y007 Hot
 Encore cartridge assembly, short
 barrel, fits KL41/45 series

Encore



KN41-Y006 Cold
KN41-Y007 Hot
 Encore cartridge assembly, short
 barrel, fits KN41/45 series

Encore



KN50-0200
Encore/Dormont pre-rinse spray valve repair kit

Encore



KN50-X025
Encore pre-rinse hose kool grip handle only, use with Encore pre-rinse spray valve and hoses

Encore

New!



KN50-X065
Encore/Dormont pre-rinse spray face plate

PREMIUM PLUMBING PRODUCTS
Encore

Amre is a full line parts distributor for Encore!

FIAT



RP-07
Fiat Service-Sink Faucet Replacement Seats. Sold individually. OEM RP07000

FIAT



GRA-09 Cold
GRA-10 Hot
Fiat Handle Assembly for service faucet. c/w index button and screw.

FIAT



GRA-02
Fiat wallmount faucet stem group assembly, includes; RP-01, RP-27, RP-21, RP-32, RP-33, RP-18, RP-24, RP-22

FIAT



GRA-11
Fiat wallmount faucet Integral Stop assembly, includes; RP-24, RP-23, RP-03, RP-21, RP-27, RP-01

FIAT



GRA-07
Fiat Vacuum breaker and disc assembly, includes; RP-26, RP-09, RP-08, RP-20, RP-06

JAMECO



ULNJ6
Jameco Cartridge For Washerless Faucets O.E.M. 004

JAMECO



ULNJ1
R.H. Hot, Jameco Washer Type Faucet Cartridge O.E.M. (1100/1101)
ULNJ2
L.H. Cold, Jameco Washer Type Faucet Cartridge O.E.M. (1100/1101)

JAMECO



ULNJ4A
Jameco Medium Seat For. Showers Size 1/2" - 22 TPI. O.E.M. 531-4 (1 Per Pack)

JAMECO



ULNJ3
Jameco Brass Seat For Faucets. Size 1/2" - 20 TPI O.E.M. 1102. (1 Per Pack)

JAMECO



ULNJ4
Jameco Brass. Elongated For. Tub & Showers. Size 1/2" - 20 TPI. O.E.M. 1103. (2 Pack)

THE BOLD LOCK OF KOHLER



ULNKH11
Kohler mixer cap assembly for Kohler K-304 Rite-Temp valve O.E.M. 77759

THE BOLD LOCK OF KOHLER



ULNKH10
Kohler All Rite-Temp pressure balancing valve repair kit O.E.M. 500520

THE BOLD LOCK OF KOHLER



ULNKH1 HOT
ULNKH2 COLD
Kohler lavatory 1/2" ceramic cartridge for two handle faucets O.E.M. 77006 and 77005

THE BOLD LOCK OF KOHLER



GP77548
Kohler cartridge for Coralais® and other single handle Kohler faucets O.E.M. 77548

THE BOLD LOCK OF KOHLER



ULNKH3
Kohler cartridge for single control Kohler faucets (Forte® Kitchen, Bol®, Vas®, Evoke™, Vanata®, and Clairette®) O.E.M. 1016515

THE BOLD LOCK OF KOHLER



ULNKH4
Kohler cartridge for various single control Kohler faucets O.E.M. 1017426

Looking for a **specific faucet part?**
Give us a call or stop in.

GALT



ULNG13K
Brass replacement seat for Galt faucets size 1/2" - 27 TPI (2 per pk) Non O.E.M. 10787

GALT



ULNG14K
Brass replacement seat for Galt faucets size 9/16" - 27 TPI (2 per pk) Non O.E.M. 10788

GALT



ULNG19
Laminated Galt stem packing (2 per pk) 10824 (1A)

GALT



ULNG18
Diverter stem for all Galtmaster tub and shower models (1965-1969) Non O.E.M.

GALT



ULNG17
Diverter stem for all Galtmaster tub and shower models (1963-1965) Non O.E.M.

GALT



ULNG8
Stem for Galtmaster tub and shower (1963-1969) Non O.E.M. 70283

GALT



ULNG7
Stem for Galtmaster tub and shower valves (1953-1963) Non O.E.M. 70281

Components

MIXET



MS5AT-C
Mixet Shower Cartridge with retainer Nut & Gaskets

MIXET



MTH-CLR Clear
Mixet Acrylic Tub & Shower Temp. Control Handle

MIXET



MDXTR-5
Mixet trim pack, deluxe volume and temperature control handles with 5-1/2" chrome flange O.E.M.

MIXET



MRH-CLR Clear
Mixet Clear Acrylic Tub & Shower Handle

Mueller



ULNMU1
Mueller Cartridge To Fit Centerset Hot & Cold 91470

Mueller



ULNMU13
Mueller Brass Replacement Seat. For Mueller Faucets. Size 17/32" - 24 TPI. (1 Per Pkg.) 146210

Mueller



ULNMU15
Mueller spindle packing

Mueller



ULNMU14
Mueller stem packing

Mueller



ULNMU12 LH (Cold)
ULNMU11 RH (Hot)
Mueller Stem To Fit. Nova & Niagara Tub & Showers. (Also Hot Side Only for Nassau). 1415139

Mueller



ULNMU9
Mueller Tub & Shower Stem To. Fit Beautycraft Mark III & Mark IV. 91286

Mueller



ULNMU10
Mueller Diverter Stem To Fit Beautycraft. Mark III & Mark IV 91406

Huge Video Library!
AMRE SUPPLY

At AMRE we understand the **importance of getting the job done, fast and efficient but also correctly!**

Well, help is here! We have added **hundreds of helpful videos** and are adding more weekly! Now you can watch **fully detailed repair instructions**, on popular repairs for **Plumbing, Appliance, HVAC, Electrical, and more...**



Stem . Cartridges . Spools



ULNMO1
Moen Two Handle
Faucets or
Wide Spread
Cartridge
O.E.M. 1224/1224B

2-1/2"

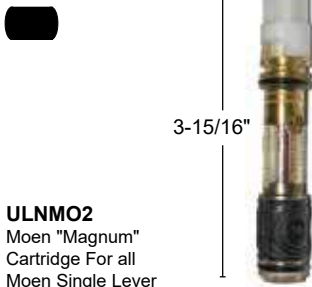

ULNMO2
Moen "Magnum"
Cartridge For all
Moen Single Lever
Faucets Since, plastic
body 1959 O.E.M.
225/1225B

3-15/16"



ULNMO3
Moen cartridge Roman Tubs (1248)



1200
Moen Brass Cartridge



1222B
Moen Posi-Temp Cartridge For Tub
& Shower



121549
Moen Commercial single lever ceramic
disc cartridge, 8413 series



1255
Moen Duralast single lever cartridge.
Used on newer model kitchen and
lavatory.



1423
Moen balancing spool



52000 Hot
52001 Cold
Moen Commercial brass shell ceramic
disc cartridge



121550 Hot
121551 Cold
Moen Commercial 2 handle plastic
shell ceramic disc cartridge



52100
Moen Commercial replacement
cartridge for metering faucets

Amre
is a **Full Line Parts**
Distributor for
MOEN

Give us a call - we have the parts
your looking for!



16352
Moen Commercial replacement car-
tridge, Sani Slowclose metering. Fits
models 8884, 8886 and 8889



104021
Moen Solenoid Valve Repair Kit for
8301, 8303 and 8304 series sensor
faucets.



96914
Moen Retainer Clip



12318
Moen Check Stop Kit



104421
Moen cartridge removal tool



13797
Moen cartridge retainer nut



91192
Moen diverter assembly



1198
Moen Pushbutton Diverter

Index Buttons



103058 hot
103059 cold
Moen II handle insert

100021
Moen handle & cap Indicator kit

13382
Moen Chateau Handle Inserts

1918
Moen Handle Cap

91751
Moen handle insert

Knobs Single Handle



100224
Moen Legend/Moentrol single lever tub/shower assembly, chrome



100657
Moen Chateau Posi-temp single lever for tub/shower, chrome



126971 Chrome
Moen Chateau single lever replacement handle for kitchen faucets. c/w hot cold insert and set screw



102564
Moen Villeta single lever for tub/shower, chrome



ULN105R
Moen Handle. OEM 14927



ULN104K
Moen Legend handle (13092)



ULN108
Moen "Chateau" Single Handle Lavatory Acrylic Handle Assm. inc. Insert & Screw O.E.M. 96791 Models: 4600/4625/64625/4621



ULN109A
Moen Handle (96884)



ULN109
Moen "Chateau" Single Handle Tub/Shower Acrylic Handle Assm. inc. Insert & Screw O.E.M. 96797/96798 Models: 2200/2435/3100/3200 2700/T471/T666/T555/13094



115000
Moen Acrylic handle w/ screw and insert



100710
Moen Handle kit, Posi-Temp 1 handle tub/shower, with white & chrome insert



14732
Moen "Chateau" Posi-Temp Single Lever Tub/Shower C.P Handle. Assm. inc. Button & Screw. Models: 2320/2370/8300. May not be exactly as shown.



93426
Moen Commercial Handle. Easy grip handle kit, vandal proof

Knobs Two Handle



14369
Moen Handle, fits Moen II. Includes 1 handle, hot & cold insert and screw



ULN106
Moen Acrylic Handle, fits Moen II. Includes 1 handle, hot & cold insert and screw. OEM 14359



14834 hot, red
14838 cold, blue
Moen wrist blade handles



113973
Moen blade handles. Per pair, c/w index buttons, rings and screws

Handle Adaptors . Drivers . Pivots



100440
Moen Lever Handle



100679
Moen Chateau lavatory handle conversion kit. Easy update from acrylic handle to ADA metal lever. Chrome



100429
Moen Handle connector Kit



100561
Moen Monticello Handle Adaptor



102568
Moen lever handle Kit



90274
Moen handle adaptor kit



14699
Moen pivot retainer



100223
Moen Handle adaptor & brake



93980
Moen handle connector kit



97344
Moen Handle extension



116653
Moen Posi Temp handle Adaptor



101099
Moen retainer clip



101310
Moen handle retainer



97556
Moen two handle adaptor kit hot and cold



10089
Moen Stop Tube



96987
Moen stop tube kit



15528
Moen Escutcheon screw, chrome



Escutcheon Parts



97491
Moen Shower Escutcheon Plate



221
Moen Shower Escutcheon Plate



16090
Moen 16090 Chateau Escutcheon, Chateau 1 handle tub/shower in Chrome



11839
Moen Spout



137401
Moen aerator and removal/install tool. Fits many models with interior aerator design



101879
Moen spout retainer

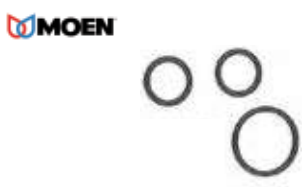

117
Moen O Ring Kit

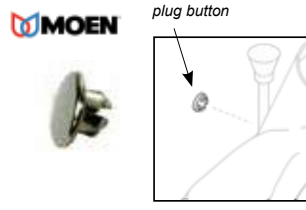

10116M
Moen plug button



M2045
Moen Pullout Kitchen Spout, Chrome



96945
Moen Handle extension 1"

Pressure Balanced / Temperature Control Valve Parts

POWERS™



900-031
Powers Shower Cartridge Kit, Pressure Balanced 900 Series/Model 2

POWERS™



800-163
Powers Shower Internal Rebuild Kit Includes Balanced Cartridge, Washers, "O" - Rings, Spring, and Stem. For Pressure Balanced 800 Series

POWERS™



401-175
Powers Shower Cartridge Kit, Series 400/410/2000 (4 Port Models)

POWERS™

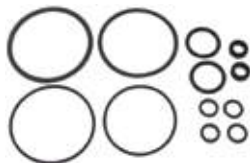

410-182
Powers Pres. Bal. Shower Gasket & Disc kit - Series 400/410/2000

POWERS™



401-176 Models 4-6
Powers Series 400 Shower Stem & Plate Replacement Cartridge Kit, Pressure Balanced.

POWERS™



410-378 Models All
Powers Series 410 Shower Stem & Plate Replacement Cartridge Kit, Pressure Balanced

POWERS™



410-183
Powers Shower Balancing Cartridge Kit, Series 400 & 410 (3 Port Model)

POWERS™



410-374
Powers Pressure Balanced Shower Dial Insert Series 410 (Models 1-5)

POWERS™



401-267
Powers Shower Sleeve Model 410

POWERS™



420-451
Replacement kits (NLA) and all orders for motors will automatically be upgraded to the new kits. Parts for the 420 valves will still be available for a limited time, however, we strongly recommend upgrading all standard range 420s (models 5-9) with the 420-451 ATA upgrade kit.
Kits replaced by 420-451 include:
227-339 420-521 420-561
227-340 420-560 420-161
227-341 420-522

POWERS™



410-371
Powers Shower Adjustable Limit Stop Series 400 (Models 1-3) Series 410 (Models 1-3)

POWERS™



900-036
Powers 900 Biltmore Series Single Lever Handle. Comes With Screw. Chrome Finish.

POWERS™



900-032
Powers Internals Kit. For Use With Powers Valves Series P902, P905 and P910. OEM

Amre carries parts for the following brands

Acorn, American Standard, **B&K**, Belanger, Belvedere, Bradley, Briggs, Cambridge Brass, Chicago, Crane, Cuthbert, Danfoss, Delex, Delta, Elkay, Emco, Fiat, Galt, Gerber, Grohe, Halsey Taylor, Haws, Jameco, Kohler, Leonard, Mixet, Moen, Mueller, Nibco, Oasis, Powers, Price Pfister, Speakman, Sterling, Symmons, T&S Brass, Teck, Wallaceberg, Waltec, Valley, Zurn

* **Bold Brands** stocking full line distributor
* Italicized Brands indicate stocking parts only
* Normal Brands indicate non stock, subject to availability

Halsey Taylor

DELTA

ELKAY

B&K

CAMBRIDGE BRASS

Delex

OASIS

PRICE PFISTER, INC.

CRANE

POWERS CRANE

American Standard

T&S

Symmons

Haws

NIBCO

MOEN

MIXET

WALTEC

STERLING

Valley FAUCETS

ZURN

BELANGER



Knob drivers extensions



ULN137AK A = 1-1/4"
ULN137BK A = 1-1/2"
ULN137CK A = 1-3/4"
 Non OEM Crane Metal C.P. Five Rib Handles. Sold in Pairs. Incl. index buttons and screws

POWERS CRANE



2020Q 1-5/16"H
2021LC 1-3/4"H
 Crane three rib chrome plated handles. Metal handle. 2/pk Non OEM

POWERS CRANE



ULN138AK Small
ULN138BK Medium
ULN138CK Large
 Crane Acrylic Handles. Sold per pair c/w index buttons and screws.

POWERS CRANE



12 PT.
 1-3/8"



ULNCR13K
 Crane Cameo Cartridge Non O.E.M.

POWERS CRANE



ULNCR15
 Powers Crane. Extended Seat For. Cameo A-205. Supply Fitting. (2 Per Pack). O.E.M. 301670

POWERS CRANE



12 PT.
 2-5/16"



OEM
039038 LH (Hot)
039037 RH (Cold)
Non OEM
ULNCR1K LH (Hot)
ULNCR2K RH (Cold)
 Powers Crane Dialese Cartridge.

POWERS CRANE



ULNCR3K (039030) LH (Hot)
ULNCR4K (039029) RH (Cold)
 Crane Dialese Stem Only. Non OEM

POWERS CRANE



ULNCR16
 Powers Crane Dialese Cartridge Repair Kit Inc. 1 Each Of Seat Washer "O" - Ring, Cork Gasket & Handle Adapter O.E.M. C7060

Don't forget to login to see wholesale pricing

www.amresupply.com

POWERS CRANE



ULNCR14K
 Powers Crane Brass Seats For Cameo Faucets Size - Non OEM (1 Per Pack) 9/16" - 18 TPI (301705)

POWERS CRANE



039035
 Crane Powers New Style O-Ring Gasket. Not Cork. OEM 039035-BP10

POWERS CRANE



ULN628 (Pkg. 5)
ULN737 (Pkg. 25)
 Crane Dialese cork gasket

Kits

Master Plumber.



O-Ring Kit

ULN716
 250 Pce. Faucet "O" - Ring Kit, Contains 12 sizes of the most popular "O" - Rings to fit cartridges & Spouts

Washer Kits

ULN744
 250 Pce. flat thin washers
 50 - #00, 50 - #0, 50 - 1/4"R, 50 - 1/4"L, 50 - 3/8"R

ULN742
 500 Pce. flat thin washers
 80 - #00, 80 - #0, 80 - 1/4"R, 80 - 1/4"L, 80 - 3/8"R, 35 - 3/8"M, 35 - 3/8"L, 10 - 1/2"R, 10 - 5/8"R, 10 - 3/4"R

ULN746
 275 Pce. assortment flat & beveled washers
 25 - #00, #0, 1/4"R, 1/4"L, 3/8"R, 13 - ULNQ767, 6 - ULNQ768 and ULNQ769

Teflon



ULN616T (1/4 R)
 Teflon Washers, 6 pk. flat

Neoprene



ULN748 17/32" (1/4 M)
ULN749 9/16" (1/4 R)
 Neoprene Washers, sold 100/pkg.

Washers

Part#	Part#	Code	Size
Flat Washers 1/8" Thick			
6/PK.	100/PK.		
ULN614	ULN747	1/4 S (00)	1/2"
ULN615	ULN748	1/4 M (0)	17/32"
ULN616	ULN749	1/4 R	9/16"
ULN617	ULN750	1/4 L	19/32"
ULN618	ULN751	3/8 R	5/8"
ULN619	ULN752	3/8 M	21/32"
ULN620	ULN753	3/8 L	11/16"
ULN621	ULN754*	1/2 R	3/4"
ULN621A	ULN755*	5/8 R	13/16"
ULN622	ULN756	3/4 R	7/8"
*50/pkg			
Beveled Washers 1/8" Thick			
Part#	Part#	Code	Size
6/PK.	100/PK.		
ULN605	ULN757	1/4 S (00)	1/2"
ULN606	ULN758	1/4 M (0)	17/32"
ULN607	ULN759	1/4 R	9/16"
ULN608	ULN760	1/4 L	19/32"
ULN609	ULN761	3/8 R	5/8"
ULN610	ULN762	3/8 M	21/32"
ULN611	ULN763	3/8 L	11/16"
ULN612	ULN764	1/2 R	3/4"
ULN612A	ULN765	5/8 R	13/16"
ULN613	ULN766	3/4 R	7/8"



MADE IN CANADA : QUALITY Replacement Part

Pfister



910-374
Stem Shower Contempra with Bonnet

Pfister



910-022
Stem Diverter with Bonnet

Pfister



910-013
Hot/Cold tub/shower compression stem

Pfister



910-030
Ceramic Disc Valve In-Wall

Pfister



910-034
Cold tub/shower stem

Pfister



974-760
Stem, Pressure Balance

Pfister



910-900
Ceramic Stem

Pfister



940-240C
Acrylic Shower Handle.
941-930A
Index button only

Pfister



974-025
Price pfister roman tub replacement cartridge

Pfister



974-044
Price pfister single lever cartridge

Pfister



974-292
Avante cartridge for single lever faucets

Pfister



910-031 Hot
910-032 Cold
Price Pfister faucet cartridge. New style. for lav faucets.

Pfister



974-291
Cartridge, Pressure Balance

Pfister



974-035
Price Pfister Replacement Cartridge
This Cartridge is a substitute for cartridge model 974-570

Pfister



974-074
S/A Cartridge, 25 mm, 529

Pfister



974-042
Replacement cartridge for 0X8 pressure balanced valve. One Piece Cartridge For Easy Retrofit or Repair

Pfister



971-250
Valve Stem Assembly

Pfister



950-910
O-Ring, Spout, 34 Series, 2/pkg

Pfister



970-800
Extension, Stem

Pfister



940-004A
Price Pfister lever handle. Chrome.

Pfister



Amre is a full line parts distributor for Pfister

Give us a call or visit us online!



Pressure Balanced / Temperature Control Valve Parts



T-52
Symmons Temptrol OEM Stop Spindle Assembly & Plaster Shield. For Use With Temptrol Stop Valve. 2/pk



12 PT



C-5
Symmons Safetymix Flow Control Spindle (Less Volume Control) O.E.M. C-5 (Replaces Volume Control Spindle SC-5, Must Order RC-14 Handle For Conversion) 1960 to Date



12 PT



TA-10
Symmons Temptrol Flow Control Spindle O.E.M. TA-10

NS-1
Symmons "Showeroff" complete Cartridge Replacement Unit Assembled and Tested



SC-3
Symmons Safetymix Renewable Seat With Gasket O.E.M. SC-3 1960 to Date (Also fits Hydapipe and Visu-temp Models)



TA-4
Symmons Temptrol Hot & Cold Renewable Seat Kit O.E.M. TA-4 1968 to Date



T-16
Symmons Temptrol Packing O'Ring and Washer Kit.



T-30
Symmons Temptrol Diverter/Volume Handle. 168 to date. Chrome.



T-65
Symmons Temptrol II Lever Handle. c/w screw and plug button, Chrome



TA-9
Symmons Temptrol Repair Kit O.E.M. TA-9



T-12A
Symmons Temptrol Cap Assembly.



RTS-061
Symmons Temptrol Tri-Handle. c/w screw and plug button. Chrome.



ULNSY3 (KIT-B)
Symmons Safetymix and Hydapipe Washer & Gasket Kit O.E.M. Kit-B



KN-4 Symmetrix
Symmons Single Lever
Kitchen Faucet Cartridge Unit

NS-13R
Symmons "Showeroff"
Washer and Gasket
Repair Kit Includes Piston
Unit, Cylinder and all
necessary Washers and
Gaskets 1983 to Date



Symmons Trim Kits Amre stocks trim kits for your existing Symmons shower valves. Want to upgrade or change looks, Symmons now offers upgrade kits for many of their existing valve assemblies, call us for ideas and pricing!



5500-REB-TRM
Symmons Elm Tub/Shower Rebuild Kit. Fits any Temptrol valve, c/w TA-10, TA-4



4700-TRM
Symmons Allura Tub/Shower Trim Kit Only. Fits any Temptrol valve.



15-2-TK
Symmons Temptrol II Tub/Shower Trim Kit with Lever handle.



T-27
Symmons Temptrol Tub/Shower escutcheon. Chrome. Use with T-29A dial plate.



T-29A
Symmons Temptrol Tub/Shower Dial plate. Model A. Use with T-27 escutcheon. See web for other styles



T-19/20
Symmons Temptrol dome cover and locknut. Includes buit-in nut.

STERLING



ULNS9K
Brass seat for Canadian Sterling tub and showers size 9/16" - 24 TPI (2 per pk)

STERLING



ULNS8K
Brass seat for Canadian Sterling faucets size 1/2" - 24 TPI (2 per pk)

STERLING



ULN157K /pr
Sterling Tempo acrylic handles. c/w index buttons. Non OEM (OEM A8369-71)

STERLING



ULNS1K RH (Hot)
ULNS2K LH (Cold)
Cartridge for all popular Canadian Sterling decks, centresets and wall type swing spout faucets

STERLING



ULNS6K
Cartridge and stem assembly for all Canadian Sterling tub and showers

STERLING



ULNS7K
Cartridge and diverter stem assembly for all Canadian Sterling tub and showers



SLOAN.



EBF-1011-A
Sloan Optima Plus solenoid valve replacement kit

SLOAN.



ETF-370-A
Sloan 24 VAC Solenoid Valve Assembly. Includes 18" (457 mm) Armored Cable And (2) Terminal Housings

SLOAN.



ETF-1023-A
Sloan Optima Male Spray Head (Aerator) with Key. 0.5 Gpm (1.9 Lpm). 15/16" M. Fits Faucets Models ETF And EBF.

SLOAN.



ESD-209-A
Sloan soap dispenser motor assembly. ESD-200

SLOAN.



AC-51
Sloan Act-o-matic shower head. Chrome plated, self cleaning eliminates clogging, 2.5GPM

SLOAN.



EAF-2
Sloan Solenoid Valve. Use with Optima IQ sensor faucets.



B-6K Complete Hot Cold Repair Kit.

000788-20 Hot Insert Only
000789-20 Cold Insert Only
000811-25 Hot Spindle Only
000812-25 Cold Spindle Only
T & S Eterna Spindle Parts Kit includes: Hot and cold Eterna insert, spindle inserts, seat washer screw, bottom & top gasket, seat washer, packing, washer, "D" - Ring. All components available separately, check website.



B-10K Complete Repair Kit
001121-45 Spray Face Only
007861-45 Spray Head Ring Only
T & S Repair Kit for B-0107 spray valves. includes: spring, bonnet washer, hose, washer, seat washer, B-0107 ring, packing, stem, valve stem. All components available separately, check website.



B-20K Hot/Cold Spindle Insert Kit
000800-25 Hot Spindle Only
000801-25 Cold Spindle Only
T & S B-1100 Parts Kit includes: Right & left hand spindle, seat washer screw, bonnet, washer, stainless steel bonnet washer, "O" - Ring. All components available separately, check website.



B-9K
Hot/Cold Handle Kit
001636-45 Cold Handle Only
001637-45 Hot Handle Only
T & S Lever Handle Kit, includes: hot & cold, handle, red & blue index buttons, lever, handle screw. Individual handles include index and screw also.



B-11K
Hot/Cold Spindle Insert Kit
000811-25 Hot Spindle Only
000812-25 Cold Spindle Only
T & S Spindle kit for use on Eterna cartridges. includes: right & left handle spindle, screws, seat washers. Or each available separately.



B-13K
T & S Spindle Kit for use with spring check. spindle assemblies includes: right & left handle spindle inserts (1-001907-25, 1-001908-25)



B-21K
Hot/Cold Insert Kit
000788-20 Hot Only Insert
000789-20 Cold Only Insert
T & S Eterna Insert Replacement Kit. includes: right & left removable insert. assembly or each sold separate.



B-23K
T & S Spring Check Spindle assembly. replacements includes: right & left hand. Eterna spindle with spring check.

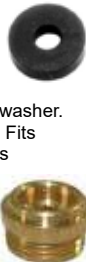

001092-45
T & S Eterna spindle seat washer. 1/2" OD 1/8" thick, 3/16" ID. Fits 000788-20/789-20 spindles



























002709-40 Cold
002710-40 Hot
T & S B-1100 Spindle Assembly. Includes spindle, lever handle, index & screw.



002713-40 Cold
002714-40 Hot
T & S Eterna Spindle Assembly. Includes spindle, lever handle, index & screw.



<p>TOTO</p>  <p>THU4127 Toto Pressure Balancing Cartridge</p>	<p>TOTO</p>  <p>THU4126 Toto Pressure Balance Spool</p>	<p>TOTO</p>  <p>THU4129 Toto Seat & Spring</p>	<p>TOTO</p>  <p>THU4141 Toto Temperature Limiting Device Assembly</p>	<p>TOTO</p>  <p>THU4125 Toto Check Stop Set</p>
<p>TOTO</p>  <p>THU4131 Toto Shower Diverter</p>	<p>TOTO</p>  <p>THU4367 Toto Thermostatic Valve Assembly</p>	<p>TOTO</p>  <p>THU4366 Toto Volume Control Diverter Valve Assembly</p>	<p>TOTO</p>  <p>THU4292#CP Toto Vacuum Breaker, Polished Chrome Finish</p>	<p>TOTO</p>  <p>1FU4008 Toto Hot Cartridge</p>
<p>TOTO</p>  <p>1FU4007 Toto Cold Cartridge</p>	<p>TOTO</p>  <p>THP4021 Toto Hot Cartridge</p>	<p>TOTO</p>  <p>THP4040 Toto Cold Cartridge</p>	<p>TOTO</p>  <p>TH559EDV545 Toto EcoPower Small Sensor With Cable, Low Lead</p>	<p>TOTO</p>  <p>TH559EDV405 Toto EcoPower Large Sensor With Cable, Old Style</p>
<p>TOTO</p>  <p>TH559EDV401 Toto Aerator Nozzle Assembly Set, Chrome Finish</p>	<p>TOTO</p>  <p>TH559EDV568 Toto Aerator Nozzle Set, Chrome Finish 0.5GPM</p>	<p>TOTO</p>  <p>TH559EDV413 Toto Solenoid & Diaphragm Assembly</p>	<p>TOTO</p>  <p>TH559EDV464 Toto Solenoid & Diaphragm Assembly, Low Lead</p>	<p>TOTO</p>  <p>TH559EDV470 Toto Solenoid & Diaphragm Assembly, Low Lead</p>
<p>TOTO</p>  <p>TH559EDV402R Toto Spout Mounting Kit</p>	<p>TOTO</p>  <p>TH559EDV403R Toto Long Spout Nut Kit With Washers, 5/pk</p>	<p>TOTO</p>  <p>TH559EDV255 Toto Metal Spring Kit</p>	<p>TOTO</p>  <p>THP3154 Toto Aerator Nozzle Key, Steel</p>	<p>TOTO</p>  <p>THP3053 Toto EcoPower Back-Up Battery</p>



TOTO[®]
AMRE SUPPLY
 Property Performance Centres
**Authorized
 Toto Parts Distributor**



Repair parts available
 for all **Toto residential and
 commercial faucets!**

Valley
FAUCETS



ULN119
Valley Acrylic Handle. For single lever. OEM V5002BG1

Valley
FAUCETS

New!



ULN117
Valley Acrylic Handle. For single lever. OEM V5013BG

Valley
FAUCETS



ULNV4
Valley Inlet Seats & Springs Fits Aqualine, Mastercraft & Some Sears Single Lever Faucets (4 Pc. Pkg.) 2 Sets O.E.M. V7059

Valley
FAUCETS



ULNV1
Valley/Sears Single Lever Control Assembly for Lavatory/Kitchen Tub & Shower O.E.M. V6680

Valley
FAUCETS



ULNV2
Valley Cartridge for 2 Handle Lavatory/Kitchen O.E.M. V6860

Valley
FAUCETS



ULNV6
Valley Single Lever Cartridge Less Diverter O.E.M. V1964BG

Valley
FAUCETS



ULNV5
Valley Single Lever Cartridge. With Diverter O.E.M. V1965BG

Valley
FAUCETS



ULNV3
Valley/Sears Single Lever Repair Kit with Wrench - Fits Aqualine, Mastercraft & Some Sears Single Lever Faucets O.E.M. V1001

Uberhaus/Rona



ULNUB1 Hot
ULNUB2 Cold
Uberhaus 1/2" plastic ceramic disc cartridge for lav faucets

Uberhaus/Rona



ULNUB3 Hot
ULNUB4 Cold
Uberhaus brass ceramic disc cartridges

TEMPRESS
Division of Corbin Canada Inc.



4103-1285 (ULNE10AA)
Danfoss Tempress II Pressure Balanced Cartridge O.E.M. with Cover "O" - Ring (062N0378)

TEMPRESS
Division of Corbin Canada Inc.



3103-1232
Danfoss Tempress II Plastic Stem Extension O.E.M. 51-197044

Wallaceburg



2-1/16"



ULNWA1K RH (Hot)
Non O.E.M. W3244
ULNWA2K LH (Cold)
Non O.E.M. W3244
Wallaceburg Old Style Sleeve Structure For Decks, Centersets & Tub & Showers cartridge

Wallaceburg



ULNWA5
Wallaceburg Diverter Assembly for All Jubilee Facemount Tub & Showers Non O.E.M. W3280

Wallaceburg



ULNWA6
Wallaceburg cartridge for Jubilee tub and shower (1950-1968) Non O.E.M. T3773

Wallaceburg



ULNWA7
Wallaceburg diverter assembly for Jubilee tub and shower (1950-1968) Non O.E.M. T3775

Wallaceburg



ULNWA9
Wallaceburg diverter assembly for Jubilee W5700 tub and shower (1968-1970) Non O.E.M. W3281

Wallaceburg



ULNWA12
Repair kit for W3244 Wallaceburg sleeve structure - contains 2 seats, 2 washers, 2 "O" rings, 2 nylon gaskets and 2 screws



MADE IN CANADA : QUALITY Replacement Part





PG8AC Water Fountain Cooler Only
PG8SBF Combo Bottle Filler / Fountain
PWSBF Bottle Filler Only(**Retrokit)
PWEBF Bottle Filler Retrokit w/display
PWSMSBF Surface Mount Bottle Filler*
 8.0 GPH at 50°F. Built-in 100 micron strainer stops particles before they enter the waterway. Waterways Are Lead-Free In Materials & Construction. Stainless Steel Top One Piece, Low Flow, Flexible Bubbler Guard. Heavy Duty Galvanized Steel Frame. High Efficiency Cooling Tank and Coil. Four Push Pad Manual Activation on lower water cooler. External Stream Height Adjustment on Lower Unit. Independent Mechanical Activation VersaFiller. ADA Compliant. **PWSBF retro-kit fits other brands but requires separate gaskets ordered separately 036689-201 Gasket for Elkay EZ & LZ and 036689-101 Gasket for Sunroc / Haws. *Cooler unit sold sep.



ELKAY

EDFP214C
Elkay Water Fountain
 Ada compliant. Front push button. Type 304 S.Steel w/satin finish. Contoured for minimal splashing. Flexi-guard safety bubbler to prevent mouth injuries. Flow regulator provides constant stream from 20-150psi pressure. 12-1/8"Wx18-3/7"Lx6-1/2"H

ELKAY

FD7003T1Z
Elkay Space-ette Floor Cooler.
 Self contained electric, 3GPH at 50degF, 115V, Single station, 12"x12"x38"H, Flexi-guard safety bubbler

ELKAY

EZS8L
Elkay Water Cooler
 Ada Compliant. Easy touch controls on front and sides. Hooded stream protector. Protected bubbler orifice to meet sanitary code. 8.0 GPH at 50°F, 115v /60hz

ELKAY EZH₂O

LZS8WSVRLK Single Station **Elkay Bottle Filling Station.**
 1.1 gpm Quick fill rate. Refrigerated provides 8 gph of water at 50°F. 30sec auto shut-off, Vandal resistant bubbler. **See web for specs and other models.**

ELKAY EZH₂O

LZWSRK
Elkay Bottle Filler Retro kit. Filtered model. Can be used with chilled or non chilled coolers. Retro Kit attaches to most 115V/60Hz EZ pushbar activated water coolers to create a bottle filling station. Retro-fit tools included.

ELKAY EZH₂O

LZWSSM 115V
EMASM Mechanical non wired **EZH2O Surface mount bottle filling station.** Filtered model. 1.5GPM or 1.1GPM when paired with a remote chiller sold separate. Installs directly onto a wall with robust hanging bracket. Remote chiller available separately.

ELKAY

LK1110
Elkay Glass Filler. 3/8"NPT, 8-1/4"H x 3"D gooseneck spout, Stainless steel with chrome finish

Save money vs bottled water

2500.CT Counter-Top
6441 Replacement Filter
Haws/Brita Hydration Station
 Fastflow, electronic dispensing, water at perfect temperature. Filter provides 1500-gallons of great tasting water.

Haws

1900
Haws Bottle Filler
 This unit is perfect as a stand-alone or easily located over virtually any fountain. Quick mount wall frame, connects to fountain water line. Push button valve.

Contact us for an onsite consultation and job quotes!





VRK5010
Haws drinking fountain valve repair kit, includes the cartridge assembly, screen and washer. Fits model 5010



VRK5874
Haws drinking fountain valve repair kit Includes washer, regulator and mesh strainer. Fits model 5874.



013059-005
Oasis valve stem assembly. Fits units with twist handle bubbler head or PAM series where valve stem is located behind push bar. Replaces 031759-001, 031759-002



029967-001 (029967-002)
Oasis Sunroc Bubbler Head Cartridge.



030774-006 With Control
030774-008 No Control
Oasis Bubbler. Continuous flow. Flexible rubber top to prevent mouth injuries. Replaces obsolete hard top bubblers 030774-002, 026551-002, 12000A



019131
Oasis Waste Gasket.



032799-005
Oasis Bubbler Head. PAM and PAC series. Flexible rubber tip. Male threaded. Adj. stream height.



033879-001
Oasis Versafilter. Fits many models of Oasis Versacooler water fountains/coolers



036930-001
Filter & Housing
037116-102
Filter Only
Oasis Galaxi replacement filters for P8AC series quarter turn EZ systems



035412-005
Oasis Activation shelf and Buttons for P8AC (No Water Control Parts)



31513C
Elkay/Halsey Taylor Cold Control Thermostat. Adjustable temperature.



56229C
Elkay Upper Shroud Assembly



35981C
Elkay Solenoid Valve. Used on Elkay EZ and Halsey Taylor HTV series with serial #'s starting with lower than 0807.



98734C
Elkay EZ Series Pushbar Kit. Includes 1 front pushbar (#55999C) and 2 side pushbars (#56002C). 10"L x 2-3/16"W. 3 Plastic tabs on back.



60290C
Elkay/Halsey Taylor Regulator Cartridge. Controls on/off and pressure.



55897C
Elkay, Halsey Taylor Watersentry VII water filter. For HWF172



56192C
Elkay Aqua Sentry replacement filter. For models with Aqua Sentry filtration system



Coolers and Fountains
51299C 1/pk
Bottle Fillers
51300C 1/pk
51300C-3PK 3/pk
Elkay Water Sentry Plus replacement filter for EZH2O models



ULN970A
Retro-fit kit for ULN970 push button drinking fountain bubbler
Includes: brass coupling nut, faucet rosette zinc faucet nut, brass nipple, faucet hole cover, C.P. flange



ULN970C
Metal/plastic cartridge for push button drinking fountain bubbler.



ULN970
Push button bubbler (head only) C.P. brass head w/metal/plastic cartridge

American Standard

Long-Life 10yr Battery Powered

American Standard Selectronic

- Exposed Flush Valves
- Advanced battery and electronics delivers up to 10yr (4000 cycles per month)
 - Exclusive Self-cleaning piston operation
 - Mechanical manual override
 - Includes sweat solder kit
 - 11-1/2" rough-in, can be installed left or right handed

Urinal 3/4" Top Spud

- 6064101.002** 0.83gpf (3.8Lpf)
- 6064051.002** 0.4gpf (1.9Lpf)
- 6064025.002** 0.21gpf (1.0Lpf)
- 6064013.002** 0.1gpf (0.5Lpf)

Closet 1-1/2" Top Spud

- 6066161.002** 1.3gpf (6.0Lpf)
 - 6066121.002** 1.07gpf (4.8Lpf)
 - 6066111.002** 0.9gpf (4.2Lpf)
- Dual Flush also available

PWRX
New
10year/480,000
cycle battery life
options



American Standard



- 6045101.002** 1.0gpf/3.8lpf
 - 6045051.002** 0.5gpf/1.9lpf
- AmStd Manual FloWise Urinal Flush Valve.
- 3/4" Top spud install
 - Includes sweat solder kit
 - 11-1/2" Rough-In
 - 3/4" stop valve
 - Self cleaning piston operated
 - Left or right hand install

American Standard



- 6047121.002** 1.28gpf/4.8lpf
 - 6047161.002** 1.6gpf/6.0lpf
- AmStd Manual FloWise Toilet Flush Valve.
- 1-1/2" Top spud install
 - Includes sweat solder kit
 - 11-1/2" Rough-In
 - Self cleaning piston operated
 - Left or right hand install

American Standard



- 6063051.002** 0.5gpf/1.9Lpf
 - 6063101.002** 1.0gpf/3.8Lpf
- AmStd Selectronic Urinal Flush Valve.
- 3/4" Top spud install
 - Includes sweat solder kit
 - 11-1/2" Rough-In
 - Battery Included
 - Self cleaning piston operated
 - Left or right hand install
 - Adj Proximity operated with manual override

American Standard



- 6065121.002** 1.28gpf/4.8Lpf
 - 6065161.002** 1.6gpf/6Lpf
- AmStd Selectronic Toilet Flush Valve.
- 1-1/2" Top spud install
 - Includes sweat solder kit
 - 11-1/2" Rough-In
 - Battery Included
 - Self cleaning piston operated
 - Left or right hand install
 - Adj Proximity operated with manual override



A923654-0070A
American Standard Flushvalve Battery 6VCR-P2

Energizer



EL223APBP 6V
Energizer 6V lithium ion battery. Replaces CR-P2



M962664-0070A
American Standard Urinal/Toilet Flushvalve Solenoid



M962666-0020A
American Standard Manual Valve



M962907-0070A
American Standard Urinal Piston Assembly

American Standard

GENUINE REPLACEMENT PARTS

Amre Supply can assist
with all parts for
American Standard
Flushvalves





81T201
Delta Teck **Manual Closet** Flush Valve
- 1-1/2" Top inlet spud mount
- 11-1/2" outlet tube
- Vacuum breaker, chloramine resistant diaphragm
- Preset at 6lpf (1.6gpf) but adj. 4.8lpf to 25lpf
- 1" FIP/Copper sweat inlet adapters



81T231
Delta Teck **Manual Urinal** Flush Valve
- 3/4" Top inlet spud mount
- 13" max height to outlet
- Vacuum breaker, chloramine resistant diaphragm
- Preset at 1.9lpf (0.5gpf) but adj. 0.47lpf to 3.78lpf
- 1" FIP/ 3/4"Copper sweat inlet adapters



New!

Solar Powered



81T201SP-MMO 6.0lpf/1.6gpf
81T201SP-48-MMO 4.8lpf/1.27gpf*
81T201SP-42-MMO 4.2lpf/1.1gpf*
Delta Solar Teck Electronic Closet Flush Valve
- 1-1/2" Top inlet spud mount
- 11-1/2" outlet tube
- Vacuum breaker, chloramine resistant diaphragm
- Preset at 6lpf (1.6gpf), but field adjustable
- *Not field adjustable
- 1" FIP/Copper sweat inlet adapter



81T201BTA
81T201BTA-20
Retro-fit for Teck Manual*
81T201BTA-30
Retro-fit for Sloan/Zurn*
Delta Teck **Closet** Flush Valve w/H2Optics® Sensor
- 1-1/2" Top inlet spud mount
- 11-1/2" outlet tube, vacuum breaker
- 4 x AA batteries included
- Hinged battery housing for easy maintenance
- Metal manual override button
- Preset at 6lpf (1.6gpf) but adj. 4.8lpf to 25lpf
- 1" FIP/Copper sweat inlet adapters
- *Retro-fit kits do not include stop, wall flange or cover tube



81T231BT
81T231BTA-20
Retro-fit for Teck Manual*
81T231BTA-30
Retro-fit for Sloan/Zurn*
Delta Teck **Urinal** Flush Valve w/H2Optics® Sensor
- 3/4" Top inlet spud mount
- 13" Max height to outlet, vacuum breaker
- 4 x AA batteries included
- Hinged battery housing for easy maintenance
- Metal manual override button
- Preset at 1.9lpf (0.5gpf) but adj. 0.47lpf to 3.78lpf
- 1" FIP / 3/4"Copper sweat inlet adapters
- *Retro-fit kits do not include stop,wall flange or cover tube



New!

Solar Powered



81T231SP-MMO 1.9lpf/0.5gpf
81T231SP-19-MMO 1.9lpf/0.5gpf*
81T231SP-05-MMO 0.5lpf/0.125gpf*
Delta Solar Teck Electronic Urinal Flush Valve
- 3/4" Top inlet spud mount
- 13" outlet tube
- Vacuum breaker, chloramine resistant diaphragm
- Preset at 1.9lpf (0.5gpf), but field adjustable
- *Not field adjustable
- 1" FIP/ 3/4" Copper sweat inlet adapter



060843A
Delta Teck II exposed flushvalve retro-fit check stem unit, capnut & button



060844A
Delta Teck II flushvalve repair kit, includes seat washer, spring, button and o'ring



061024A
Delta Teck II exposed flushometer regulating screw & o-ring



New!



060683A
Delta flush valve hardwire converter. 24VAC to 6.4VDC



061161A Water Closet
061162A Urinal
Delta Commercial Cam E-Flushvalve kit. Includes E-Board and button



060782A (70255)
Delta Teck II flushvalve vacuum breaker assembly. 1-1/2"x10"



New!

060679A
Delta Flush valve wall sensor override button

New!

060671A
Delta Teck flush valve solenoid valve



060082A 20/pk
Delta Teck II adjustable tail o'ring



060507A Water Closet
060508A Urinal
Delta Teck II flushvalve poppet pin



urinal / water.closet.concealed.exposed



Cambridge Brass/Teck/Delta Commercial Flush Valve Parts (Also known as Tempus)

Exposed and Concealed Flush valve parts Models: 81T (pre 1970), 81T, 82T (pre 1975), 83T (after 1975) Electronic models 1000T6/1000T9/2000T6

EXPOSED

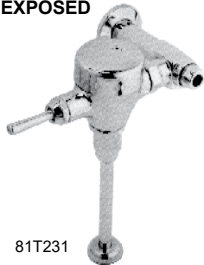

81T231

ULN900 (76600)
Teck/Cambridge Brass universal washer and "O" ring kit for all models except 82T (pre 1975). Kit includes:

10529 Fibre Gasket	16014 "O" - Ring
10546 Fibre Gasket	10613 "O" - Ring
10316 Diaphragm	10718 Fibre Gasket
10515 Handle Seat washer	16855 Screw
16152 Handle Seat Washer	16016 "O" - Ring
10528 Leather Gasket	16012 "O" - Ring
16364 Flexible Washer	T683 "O" - Ring
10790 Push Pin	T683 "O" - Ring
10331 "O" - Ring	76600 (TV107)



CONCEALED



2000T6

ULN901 (76601)
Teck/Cambridge Brass universal Parts, Washers & "O" ring kit for all models except

82T (pre1975). Kit includes:

10529 Fibre Gasket	10331 "O" - Ring
10510 Regulating Screw	16014 "O" - Ring
10546 Fibre Gasket	10613 "O" - Ring
10316 Diaphragm	10718 Fibre Gasket
10515 Handle Seat Washer	16855 Screw
10808 Spring	77191 Handle Cage s/a
10528 Leather Gasket	10347 Spring
16364 Flexible Washer	76601 (TV111)
10790 Push Pin	
10522 Spring	
16361 Relief Valve	



ULN902 (76602)

Teck/Cambridge Brass universal handle repair kit except for 82T (pre 1975) and electronic models.

Kit includes:

77191 Handle cage s/a	
17264 Relief valve	
16152 Seat washer	
17283 Spring	10343 Bonnet
16016 "O" - Ring	10615 Handle gland
17265 Cage	17490 Plastic insert
T683 "O" - Ring	10344 Handle
17266 Push pin	17495 Bonnet (Teck I)
10347 Spring	17494 Handle gland (Teck II)
10344 Handle	76602 (TV50)
16323 Rubber washer	



ULN901A (77191)

Teck/Cambridge Brass universal handle repair kit except for 82T (pre 1975) and electronic models. Kit includes: Handle Cage and "O" ring.



ULN903 (10316)

Cambridge Brass diaphragm



ULN905 (70230)

Cambridge Brass guide with diaphragm.



060843A

Cambridge Brass check stem kit includes stem unit, capnut and button for exposed models 81T after 1970



060779A

Teck/Cambridge Brass diaphragm & guide assembly



060083A

Teck/Cambridge Brass 1-1/2" slip joint washer kit, 12/pk



urinal metering valve parts.exposed



Models: 86T5



86T505

061233A

Cambridge brass metering unit only



ULN906 (190009A)

Cambridge Brass C.P. Pushbutton kit, includes: set screw, button, allen screw and metering unit



ULN906A (190010A, 061245A)

Cambridge Brass oscillating handle metering unit replacement kit, includes: metering cartridge, keeper, plastic button.



ULN904 (70267)

Cambridge Brass OEM universal V.B. sleeve, all models including concealed electronic models 1000T6/1000T9/2000T6



061246A

Cambridge Brass C.P. oscillating handle kit, includes: plastic handle sleeve, handle, spring and bonnet



060841A

Cambridge Brass C.P. Pushbutton assm., includes: set screw



ULN904K

Generic Replacement vacuum breaker for Cambridge Brass





Known for many years in Canada as Crane Presto, these flushvalves were manufactured by Delany products and are now again available in Canada.



P402-G-T42 (402VB)
Water Closet 3.0 – 20.0 L @ 690 KPa Delany Presto flush valve. Exposed with vacuum breaker. Heavy cast brass body, diaphragm operation, anti-siphon stop assembly, and 1" NPT female inlet with 1" copper sweat adaptor. Metal oscillating handle.



P451-1-T42 (451VB)
Urinal 3.6 – 26.0 L @ 690 KPa Delany Presto flush valve. Exposed urinal flush valve with vacuum breaker. Heavy cast brass body, diaphragm operation, anti-siphon stop assembly, and 3/4" NPT female inlet with 3/4" copper sweat adaptor. Metal oscillating handle.

Water Closet Flush Valve Parts Models: 402VB, 404VB, 414VB, 534VB, 544VB, 625VB



039002
Powers Crane 1-1/2" Flush valve repair kit



039008
Powers Crane 1-1/2" Flush valve repair kit



302075
Powers Crane 1-1/2" flushvalve diaphragm only

POWERS CRANE

3/4" Urinal Flush Valve Parts Models: 451, 451VB, 452VB, 571VB



039003
Powers Crane 3/4" Flush valve repair kit



039007
Powers Crane 3/4" Flush valve repair kit



302096
Powers Crane Flush Valve Handle Nut, 402VB / 451VB / 404VB / 414VB

Don't forget to login to see wholesale pricing

www.amresupply.com



P107-1U
Powers Crane 3/4" Flush valve diaphragm only



302077
Powers Crane Flush Valve Stop Gasket, fits most models



302115
451VB/571VB Powers Crane Flush Valve Seat Guide



ULN717 5/pk Valve stop O-ring. 402VB/451VB.



14-65
Delany/Powers flush valve o-ring, Fits models 402VB/404VB 451VB/414VB



302874
Flush valve stop spring. 402VB/451VB



52-4
Delany/Powers flush valve shut-off stem.



301205
Flush Valve stop bumper. 402VB/451VB



300758
Powers Crane Flush Valve Clamping Ring, 402VB /451VB /404VB /414VB

POWERS CRANE FLUSH VALVE PARTS, FITS BOTH WATER CLOSET & URINAL 402VB/451VB



New style Delany



P223-2
Delany flush valve handle stem with nylon tip. 1-15/16"L. Fits P451-1-T42 and F402-G-T42 etc Delany brand flush valves.



039049
Powers Crane flushmeter auxiliary valve, also comes in 039008/039007 parts kits



039048 1-5/8"L Powers Crane flush valve stem. For older style Powers 402VB/451VB



302022
Powers Crane rubber flexer



302002
Powers Crane vacuum breaker sleeve with insert



21842
Replacement vacuum breaker for Crane, Sloan & Zurn



D182
Powers Crane closet flush valve complete stop assembly. Fits 402VB. 1" NPT



D184
Powers Crane urinal flush valve complete stop assembly. Fits 451VB. 3/4" NPT



P333A
Powers Crane handle



23-5A
Delany flush valve disc with insert. Fits most Delany models.

Commercial Faucets Any Brand . Any Model . Any Job Call us for competitive quotes on any of your needs!



See website
www.amresupply.com
for more models!



G2 Battery-Powered Sensor Operated Urinal flushometers – for Exposed flushometer for 3/4" Top Spud Urinals.

Part Optima Plus®
3250401 G2 8186-1, 1.0 gpf/3.8 Lpf



G2 Battery-Powered Sensor Operated Water Closet flushometers

Battery-Powered Sensor Operated Control Module and Flex-Tube Diaphragm flushometer with Angle Stop, Vacuum Breaker Flush Connection, Sweat Solder Kit with Cover Tube and Cast Set Screw Wall Flange – for Exposed flushometer for 1-1/2" Top Spud Bowls.

Part Optima Plus®
3250400 G2 8111, 1.6 gpf/6.0 Lpf



Sloan SOLIS® Urinal flushometers
Exposed, Solar-Powered Sensor Activated Sloan SOLIS® flushometer with Angle Stop, Vacuum Breaker Flush Connection, Sweat Solder Kit with Cover Tube and Cast Set Screw Wall Flange – supplied less Handle Opening and with Metal Cover. (4) "AA" battery backup, 3/4" Top Spud Urinals.

Part SOLIS
3370004 8186-0.5 0.50 gpf/1.9 Lpf



Sloan SOLIS® Water Closet flushometers

Exposed, Solar-Powered Sensor Activated Sloan SOLIS® flushometer with Angle Stop, Vacuum Breaker Flush Connection, Sweat Solder Kit with Cover Tube and Cast Set Screw Wall Flange – supplied less Handle Opening and with Metal Cover. (4) "AA" battery backup, 1-1/2" Top Spud Bowls.

Part SOLIS
3370001 8111-1.6 1.6 gpf/6.0 Lpf
3370002 8111-1.28 1.28 gpf/4.8 Lpf



G2 RESS Retrofit Kits for Sloan Royal® or Regal®
Battery-Powered Sensor Operated Control Module and Flex-Tube Diaphragm Inside Parts Kit, 4 AA Alkaline batteries. Installation Strap Wrench and Screwdriver included. Kits must be ordered to meet Flush Volume requirements of existing or new Water Closets and Urinals

Part G2 Optima Plus®
3325400 Retrofit Kits for 3.5 gpf or 1.6 gpf Water Closets – Royal® or Regal®
3325402 Retrofit Kits for 1.5 gpf or 1.0 gpf Urinals – Royal® or Regal®



Regal® Exposed Urinal flushometers

Economy flushometer with traditional Natural Rubber Segment Diaphragm with Fixed Metering By-Pass, ADA Compliant Handle. Fixed Volume Accuracy w/ Para-Flo Technology.

Part REGAL
3082653 186 XL Water Saver (1.5 gpf/5.7 Lpf)
3082675 186-1 XL. -1.0 Low Consp. (1.0 gpf/3.8 Lpf)



Regal® Exposed Water Closet flushometers
Economy flushometer with traditional Natural Rubber Segment Diaphragm with Fixed Metering By-Pass, ADA Compliant Handle. Fixed Volume Accuracy w/ Para-Flo Technology.

Part REGAL
110XLYO 110 XL YO Water Saver (3.5 gpf/13.2 Lpf), Bumper on Angle Stop
111XLYO 111 XL YO -1.6 Low Consumption (1.6 gpf/6.0 Lpf), Bumper on Angle Stop



Easy Installation
Works out of the box and installs in minutes.
Simply slide the unit over the Flushometer handle and tighten the clamp.

EBV-200-A
Battery Powered, Sensor Activated, Exposed, OPTIMA® SMOOTH™ Unit for Closet and Urinal Flushometer Conversions with the following features:



EBV-89A-M
Quiet, Exposed, OPTIMA®, Battery Powered, Sensor Operated Closet and Urinal Flushometer Retrofit Conversion Kit. can be used on standard rough-in Sloan Royal, Regal, Crown and Naval & Zurn and Helvex.



WES-150
Sloan/Falcon Waterfree Urinal Cartridge Kit.
Lasts approx 7000 uses. Includes 1 each Cartridge, Key, Sealant Package, Glove and Disposal Bag



C-100500-K
Sloan Flushmate Cartridges
All series EXCEPT for the 200 Series



B-108288
Duckbill Valve. Fits inside the upper supply. It is used on ALL Sloan Flushmate systems. The duckbill valve acts as a one-way check valve that allows air into the tank, but will not let air or water out of the tank.



Royal

SLOAN.



Water Closets

- A-1045-A** 1.28gpf/4.8lpf
 - A-1041-A** 1.6gpf/6.0lpf
 - A-1038-A** 3.5gpf/13.2lpf
- ### Urinals
- A-1050-A** 0.125gpf/0.5lpf
 - A-1047-A** 0.25gpf/1.0lpf
 - A-1043-A** 0.5gpf/1.9lpf
 - A-1042-A** 1.0gpf/3.8lpf
 - A-1037-A** 1.5gpf/5.7lpf
- Sloan Flush Valve Diaphragm Assemblies

Royal

SLOAN.



Water Closets

- A-1101-A** 1.6gpf/6.0lpf
 - A-1102-A** 3.5gpf/13.2lpf
- ### Urinals
- A-1106-A** 0.5gpf/1.9lpf
 - A-1107-A** 1.0gpf/3.8lpf
 - A-1108-A** 1.5gpf/5.7lpf
- Sloan Flush Valve Performance Kits. Includes Dual Filtered Diaphragm Assembly, handle Repair Kit with triple seal packaging, high back pressure vacuum breaker repair kit, and one tailpiece o-ring.

SLOAN.



CN-1002-A Closet
Sloan Naval Flushometer Piston with main seat.

SLOAN.



F-5-A-3/4 3/4"
F-5-A-114 1-1/4"
F-5-A-112 1-1/2"
Sloan Flushometer C.P. Spud Coupling Assembly. 4pc.

SLOAN.



H-553
Sloan Flushometer Tailpiece O'Ring

SLOAN. Royal repair parts

- V-600-AA-34** 3/4" x 9"
- V-600-AA-1.5** 1-1/2" x 13-1/2"

Sloan Flushometer Vacuum Breaker Flush Connection. Chrome Plated. For Use With Royal Flush Valves.



SLOAN.



- A-19-AC** White Closet
 - A-19-AU** Black Urinal
 - A-19-ALC** Green LC Closet/Urinal
- Sloan Flush Valve Relief Valves. Fits Regal and Royal models

Regal/Royal

SLOAN.



Water Closets

- A-41-A** 1.6gpf/6.0lpf
 - A-44-A** 2.4gpf/9.0lpf
 - A-38-A** 3.5gpf/13.2lpf
 - A-36-A** 4.5gpf/17.0lpf
- ### Urinals
- A-43-A** 0.5gpf/1.9lpf
 - A-42-A** 1.0gpf/3.8lpf
 - A-37-A** 1.5gpf/5.7lpf
- Sloan Flush Valve Diaphragm Assemblies.

SLOAN.



A-163-A
Sloan flush valve guide assembly. Fits water closets 4.5gpf/17.0lpf and urinals 1.5gpf/5.7lpf

A-152-A
Sloan flush valve guide assembly. Fits water closets 3.5gpf/13.2lpf



A-156-A
Sloan Diaphragm



A-156-AA (575-022)
Royal/Regal Diaphragm Repair Kit Includes A-15-A Disc, A-156-A Diaphragm, B-39 Handle Seal



B-50-A (Regal)
B-51-A (Royal)
Handle Repair Kit

A-71
Sloan Inside Cover



A-15-A
Sloan molded disc



B-39 (575-019)
Royal/Regal Handle Seal



B-32-A (575-008)
Royal/Regal Handle Assembly



PRE
1972



A-56-AA (575-021)
Royal/Regal Diaphragm Repair Kit with Copper Gasket Pre 1972, Includes A-15-A Disc, A-56-A Diaphragm, B-39 Handle Seal

PRE
1972



A-56-A (575-020)
Royal/Regal Diaphragm with Copper Gasket Pre 1972, Includes B-39



V-551-A (Regal)
V-651-A (Royal)
Vacuum Breaker Repair Kit



21842
Universal vacuum breaker. Fits Sloan, Zurn and others

urinal / water.closet.handsfree

Flex tube Diaphragm kits for G2, Optima Plus, ECOS, Solis

OPTIMA PLUS & G2 OPTIMA PLUS

Electronic flush valve repair parts



Water Closets

- EBV-1024-A** 1.28gpf/4.8lpf
- EBV-1020-A** 1.6gpf/6.0lpf or 3.5gpf/132lpf or 4.5gpf/17.0lpf
- EBV-1021-A** 2.4gpf/9.0lpf

Urinals

- EBV-1025-A** 0.125gpf/0.5lpf or 0.25gpf/1.0lpf
- EBV-1023-A** 0.5gpf/1.9lpf
- EBV-1022-A** 1.0gpf/3.8lpf

Sloan Flex Tube Flush Valve Diaphragm Kits. Includes multiple regulators, used on G2, Optima, Plus, ECOS and Solis series models.



- Sloan regulators
- EBV-95** Green
 - EBV-102-2** Black
 - EBV-102-1** White



EBV-1042-A
Sloan Flushmeter Override Button Replacement. For Use With Old Style Optima Plus Flushometers, Pre G2 Flushometers.



Black Module Optima

EBV-144-A Urinal/Closet
Sloan Optima Plus Modules isolated solenoid operator. For use with Black Optima Plus EBV-26-A Modules only (produced 1992-2003) (identified by a Blue Module) use the EBV-136-A Solenoid

Blue Module Optima



EBV-136-A Urinal/Closet
Sloan G2 Optima Plus Solenoid Operator, 2003-current. Also fits ECOS & Solis

1992-2003



EBV-146-A-U Urinal
EBV-146-A-C Closet
Sloan Optima Plus Module replacement

2003 - current



EBV-130-A
Sloan G2 override button assy.



WES-23-A
Sloan ECOS override button assembly



EBV-21-A
Optima Plus Cover and solenoid 1992-2003
EBV-145-A
G2 Optima 2003 to current
Sloan inside cover and solenoid

EBV-129-A-U Urinal
EBV-129-A-C Closet
Sloan G2 Elec. module
EBV-196-A Dual Flush ECOS



EBV-55-A (no override)
EBV-60-A (override button)
EBV-67 Cover gasket sold sep.
Sloan Optima metal cover urinal



EBV-142-A
G2 Sloan Cover Assembly



EBV-311-A Dual Flush
EBV-309-A Single Flush
Sloan Solis Cover Assemblies

Sloan Concealed Optima Parts



EL-1500 Urinal
EL-1500-L Closet (Royal) Sensor



EL-128-A
Actuator Cartridge (Royal/Regal)



EL-124-2 Exposed
EL-138-2 Concealed
24VAC Solenoid Assy.



EBV-18
Sloan Optima quad seal



Auto Flush

Auto Flush Clamp



- 401804A** Urinal
- 401805A** Closet
- TC Flushometer Retro-fit Clamp on Auto-Flush Kit.
- Simply slides over handle for quick install
- Fits Sloan & Zurn Flush Valves
- Uses 4xC batteries
- Adjustable sensor range
- Lasts 60,000 flushes

401973
Adapter required
Use on Crane/Teck/Tempus



For Sloan & Zurn flush valves

- 401186A** Urinal
- 401187A** Closet

For Coyne & Delany flush valves

- 401207A** Urinal
- 401206A** Closet

- Ensuring urinals & toilets are always flushed, clean, odour-free & presentable.
- Retrofit Automatic Flushing Unit
- New Improved Design
- Smart Object Infrared Technology
- Easy 2 Minute Retrofit Installation
- 3 11/16 inch D x 4 5/8 inch W x 2 7/8 inch H

Metered - Dispenser



- 500590** LCD Chrome Dispenser Kit w/ 3/4" Conn.
 - 400586** Purinel® – Drain Maintainer and Cleaner
 - 401591** Cleaner and Deodorizer, Linen Fresh
 - 401532** Cleaner and Deodorizer, Mandarin Orange
- AutoClean® systems deliver powerful formulas that attack and eliminate odors at the source—automatically cleaning fixture surfaces, day and night.
- Easy in-line installation
 - Easy drill-through chrome connection kit; no need to shut off water
 - Refills deliver consistent metered dosage of Purinel® SC to prevent buildup of calcium on pipes and scaling
 - Up to 90-day refill cycle settings
 - Up to 3 year battery life



- 8310** 1-1/2" Closet 1.6gpf/6.0lpf
 - 8312** 3/4" Urinal 1.0gpf/3.8lpf
- Moen M-Power Sensor Flush Valve
Brass construction, 1" IPS supply, Adjustable sensor eyes, Battery powered (4) standard AA (included), Average battery life 250,000 cycles, Self-diagnostic electronics, Piston flushing mechanism, Self cleaning filter system, Low battery indicator light



- 8310M16** 1-1/2" Closet 1.6gpf/6.0lpf
 - 8312M10** 3/4" Urinal 1.0gpf/3.8lpf
- Moen Manual Flush Valve
Brass angle stop valve, Cast brass construction, Chloramines resistant seals, 1" IPS inlet supply, High back pressure vacuum breaker, ADA compliant, AccuSet™ piston technology, Self-cleaning filter, Top spud

Parts



- 104437**
Moen M-Power commercial flush valve piston control disc.



- 104461**
Moen polished chrome manual override button.



- 104570**
Moen commercial flush valve vacuum breaker kit

New!



- 104435**
Moen flush valve solenoid coil kit

dyson



**AMRE is now an authorized stocking
Dyson Hand Dryer, Fan, & Vacuum
Distributor.**

dyson airblade

**Call us today for more
information or to book on on-site demo
or consultation!**



TOTO OUR MOST COMMON TOTO ELECTRONIC FLUSHVALVE PARTS



TMU1LN-12 1.9lpf/0.5gpf

TMU1NNC-12 3.8lpf/1.0gpf

Toto Urinal Manual Flush Valve. Piston valve, left or right rough-in, top sud exposed, non hold open, 3/4" angle stop, 3/4" vacuum breaker.



TMT1LN-32 4.8lpf/1.28gpf

TMT1NNC-32 6.0lpf/1.6gpf

Toto Closet manual flush valve. Solid bronze piston valve, positive seal, self cleaning screen, easy retrofit replaces most valves, 1" angle stop, 1-1/2" vacuum breaker, top exposed spud.



TET1LA-32 4.8lpf / 1.28gpf

TET1GA-32 6.0lpf / 1.6gpf

Toto EcoPower Toilet Flush Valve. Self-powered hydroelectric flush valve, self-cleaning piston, Neutral rough-in and adjustable tail piece, self-adjusting sensor, 1-1/2" top spud, 1" angle stop and 1-1/2" vacuum breaker

Improved Features.
No more daily minimum usage!



TEU1UA-12 0.47lpf / .125gpf

TEU1GA-12 3.8lpf / 1.0gpf

Toto EcoPower Urinal Flush Valve. Self-powered hydroelectric flush valve, self-cleaning piston, Neutral rough-in and adjustable tail piece, self-adjusting sensor, 3/4" top spud, 3/4" angle stop

Improved Features.
No more daily minimum usage!



TH559EDV503

(Toilet)

TH559EDV504

(Urinal)

Toto Ecopower Flushvalve Hydro-Power Generator



TH559EDV518

(Toilet)

TH559EDV519

(Urinal)

Toto Ecopower Flushvalve Controller



THP3053

Toto Ecopower Flushvalve Electronic Back-Up Battery



TH559EDV515

Toto Ecopower Exposed Flushvalve Sensor Controller & Packing Set

TH559EDV550

Toto Ecopower Concealed Flushvalve Sensor Controller & Screws Set

TOTO OUR MOST COMMON TOTO MANUAL FLUSHVALVE PARTS



TH323V103R



TH323V104R

Toto Ecopower Flushvalve Piston Assembly

TH323V103R

(1.6/1.28 GPF) toilet

TH323V104R

(1.0/0.5 - 3.5 GPF)



TH559EDV510R

Toto Ecopower Flushvalve Solenoid Unit & Diaphragm Piston Assembly



TH305SV1

Toto Manual Urinal Flushvalve Lever Assembly includes THY326



THY326

Toto Manual Toilet Flushvalve Push Button Assembly



TH559EDV506

Toto Ecopower Flushvalve Manual



TH323V100R



TH323V102R

TH323V100R

Toto Manual Flushvalve Piston Valve Assembly (1.28 GPF) Toilet

TH323V102R

Toto Manual Flushvalve Piston Valve Assembly (1.0 GPF) Urinal

There are many Obsolete Flushvalve pistons still available, please provide us with exact model number



TH559EDV306R

Toto wc piston assy

We carry **100's** of **Tools** to help with any **installation projects!**

Visit us online!
www.amresupply.com



TH559EDV338

Toto wire cable



TH305SV106

Toto flush valve tail piece o-ring kit. 10/pk



Flushmeter **Parts** controllers . breakers . toto . toilet parts

TOTO® OUR MOST COMMON TOTO ELECTRONIC FLUSHVALVE PARTS

TOTO®

New!



9BU002E
Toto Flush Valve gasket

TOTO®



TH305SV103
Toto Toilet & Urinal Flushometer
U-Packing Set, 10/pk

TOTO®



TH559EDV301
Toto Toilet & Urinal Flushometer
Double Sems Screws Set

TOTO®



10077T3
Toto Toilet & Urinal Flushometer
Complete 1" Angle Stop, Pol-
ished Chrome Plated

TOTO®



10077T3-PM
Toto Toilet & Urinal Flushometer
1" Angle Stop Repair Kit

TOTO®



10077T3-XQ
Toto Toilet & Urinal Flushometer
1" Angle Stop Cap, Polished
Chrome Plated

TOTO®



92013MZ
Toto Toilet & Urinal Flushometer
Vacuum Breaker Repair Kit

TOTO®



10075T1
Toto Toilet Flushometer 1-1/2"
x 9" Vacuum Breaker, Polished
Chrome Plated

TOTO®



10077T4
Toto Toilet & Urinal Flushometer
Complete 3/4" Angle Stop, Pol-
ished Chrome Plated

TOTO®



10077T4-XQ
Toto Toilet & Urinal Flushometer
3/4" Angle Stop Cap, Polished
Chrome Plated

TOTO®



10075T2
Toto Urinal Flushometer 3/4" x
9" Vacuum Breaker, Polished
Chrome Plated

TOTO®



10075T1L
Toto Urinal Flushometer 1-1/2"
x 24-1/2" Vacuum Breaker, Pol-
ished Chrome Plated

TOTO®



Z-4000J
Toto Ground Adapter for Joint
Angle Stops



TOTO®

New!



TH559EDV337
Toto Flush Valve push button &
clip. Chrome finish

AMRE SUPPLY
Property Performance Centres

Authorized Toto Parts
Distributor for **water closet** and
urinal flushmeters - In Stock!



ZURN Battery Powered 10Year Long Life

Closet (1-1/2")

- ZTR6200EV-WS1-LL 1.6gpf
- ZTR6200EV-LL 1.28gpf

Urinal (3/4")

- ZTR6203-EWS-LL 0.5gpf
- ZTR6203-WS1-LL 1.0gpf
- ZTR6203-ULF-LL 1.25gpf



Exposed chrome plated flushometer

- 4 "AA" Long Life batteries 10 year battery life
- Manual Override Button, Control Stop
- Vandal resistant stop cap, Vacuum Breaker
- Adjustable tailpiece, 11-1/2", sweat kit
- Spud coupling and flange for top spud connection
- Chemical resistant components

ZURN



ZER6200-HET-CPM 1.28GPF

ZER6200-WS1-CPM 1.6GPF

Aquasense sensor operated battery powered flush valve Metroflush for water closets (Toilets). Metal cover.

ZER6203-WS1-CPM 1.0GPF

ZER6203-EWS-CPM 0.5GPF

Aquasense sensor operated battery powered flush valve Metroflush for 3/4" urinals. Metal cover.

ZURN



Closet (1-1/2")

- ZER6000AV-CPM 3.5gal/13L
- ZER6000AV-WS1-CPM 1.6gal/6L

Urinal (3/4")

- ZER6003AV-CPM 1.6gal/6L
- ZER6003AV-WS1-CPM 1.0gal/6L
- ZER6003AV-EWS-CPM 0.5gal/3L

Zurn AquaSense AV Exposed Sensor Operated Battery Powered Flush Valve. Chloramine and clog resistant dual seal diaphragm, vacuum breaker, adjustable tailpiece, spud coupling and flange, impact resistant sensor module, ADA compliant, override button

ZURN



Z6203-EWS-YB-YC 0.5GPF

Z6203-WS1-YB-YC 1.0GPF

Metroflush piston-operated flush valve for 3/4" urinal valves. w/sweat solder kit and cast wall flange.

Z6200-HET-YB-YC 1.28GPF

Z6200-WS1-YB-YC 1.6GPF

Metroflush piston-operated flush valve for water closets (toilets). Also available in dual flush add -DF. W/sweat solder kit and cast wall flange.

ZURN



A



Zurn Flush Valve for Water Saving Closets - AquaVantage

Diaphragm operated brass flush valve with polished chrome exterior. ADA compliant handle and a 1" [25mm] screwdriver operated angle stop valve with siphon-gard backcheck protection. Cast wall flange with setscrew, sweat solder kit, vandal-resistant control stop cover, vacuum breaker, 1-1/2" [38mm] flush tube, fixture spud escutcheon, and fixture spud securing nut.

Part Number	A=	Gal	Litres	Size
Z6000AV-1	16"	3.5	13L	1-1/2"
Z6000AV	11-1/2"	3.5	13L	1-1/2"
Z6000AV-WS1	11-1/2"	1.6	6L	1-1/2"
Z6000AV-HET	11-1/2"	1.28	4.8L	1-1/2"

ZURN



A



3/4" Illustrated

Zurn Flush Valve for Water Saving Urinals - AquaVantage

Diaphragm operated brass flush valve with polished chrome exterior. ADA compliant handle and a 3/4" [19mm] screwdriver operated angle stop valve with siphon-gard backcheck protection. Cast wall flange with setscrew, sweat solder kit, vandal-resistant control stop cover, vacuum breaker, 3/4" [19mm] flush tube, fixture spud escutcheon, and fixture spud securing nut.

Part Number	A=	Gal	Litres	Size
Z6001AV-WS1	11-1/2"	1.0	4L	1-1/4"
Z6003AV	11-1/2"	1.5	6L	3/4"
Z6003AV-WS1	11-1/2"	1.0	4L	3/4"
Z6003AV-EWS	11-1/2"	0.5	2L	3/4"





ZERK-CPM

Zurn AquaSense® E-Z Flush battery sensor retrofit kit. Fits many Zurn and Sloan flush valves. 4 C batteries included, ADA compliant, 3 yr warranty, easy install. Other model adapters available.



- P6000-EUR-WS** Urinal 1.5gpf
- P6000-EUR-WS1** Urinal 1.0gpf
- P6000-ECR-WS** Water Closet 3.5gpf
- P6000-ECR-WS1** Water Closet 1.6gpf
- Zurn Aqua Flush Diaphragm Kits
- P6000-EUA-WS** Urinal 1.5gpf
- P6000-EUA-WS1** Urinal 1.0gpf
- P6000-ECA-WS** Water Closet 3.5gpf
- P6000-ECA-WS1** Water Closet 1.6gpf
- Zurn Aqua Vantage Diaphragm Kits



New!



- PR6000-EU-WS** Urinal 1.5gpf
- PR6000-EU-WS1** Urinal 1.0gpf
- Zurn ZRK and ZR6000 Series Diaphragm Kits



- P6000-ECA-WS-RK-CS** Water Closet 3.5gpf
- P6000-ECA-WS1-RK** Water Closet 1.6gpf
- P6000-EUA-WS-RK-CS** Urinal 1.5gpf
- P6000-EUA-WS1-RK** Urinal 1.0gpf
- Zurn AquaVantage Rebuild Kit



- P6000-B**
Zurn Flush Valve Vacuum Breaker Repair Kit



- PERK6000-RK**
Zurn Flush Valve Plunger repair kit



- P-6000-H**
Zurn Flush Valve Spud coupling assembly 1-1/2"



- PR6000-M**
Zurn Solenoid kit for ZRK & Z6000 series



- P6000-D-SD**
Zurn Stop repair kit, 3/4" & 1"



- PERK6000-SR**
Zurn Sensor module round lens



- P6000-L**
Zurn Flush Valve inside cover



- P6000-E14**
Zurn Molded Disc. For Use With Diaphragm Kit. 2" Diameter. For use in Zurn AquaVantage / Aquaflush & Sloan Royal / Regal valve bodies. 3-year warranty



- P6000-ER15**
Zurn Flush Valve Diaphragm kit, with 3.0/3.5gpf, 1.5/1.6gpf & 1.0gpf flow rings



- P6000-M-ADA** 5-1/2"
ADA Compliant
Zurn flush valve handle assembly



- PR-6000-MB**
Zurn Battery holder



- P6000-VC**
Zurn Flush Valve Vandal resistant cover for stops, fits 3/4" & 1"



- PR6000-SH**
Water closet sensor 3.0-4.5gpf
- PR-6000-SL**
Urinal 1.0-1.6gpf
Zurn ZRK Series & ZR6000 series





1650001
Waterline Water Sensing Alarm, 9V DC 6' Sensor Wire. No installation required; just place on the floor near water sources and it will detect as little as 1/32" of water. Requires 9v alkaline battery (sold sep.)



1009923
SJE Rhombus Indoor/Outdoor Tank Alarm. Can be used as a high or low level alarm. Includes control switch with 15ft cable and mounting clamp.



OS&B Internal Battery Lasts up to 3 Years!
FBP-01D Flood Buzz Pro Water Leak Alarm
OS&B Flood Buzz Pro Water Leak Alarm. Flood Buzz™ Pro is designed to detect water and sounds a 110dB alarm upon contact. Simply place on the floor near any potential water leak or flood source like toilets, hot water tank, washers, dishwashers, sump pump etc.
- No buttons to push, no programming to worry about, and
- 110 dB alarm
- Reusable and simple to test
- Maintenance free until you replace it.

PRO PICK

LittleGIANT
"Protect your property with an alarm"



513379 9V Little Giant low voltage indoor high water alarm. 6ft cable, 9v battery sold sep. 85dB alarm, low battery warning, test button

New!



1011421
SJE Rhombus High Level Water Alarm. Provides audio/visual warning of potential threatening liquid level. Includes 15ft cable and mounting clamp.

LittleGIANT Convert any manual pump to an automatic pump, up through 1/2 HP or 1 HP

599118 115/230V, 1/2-1 hp - w/10ft cord
599117 115/230 V 1/2-1 hp - w/15ft cord
599210 115/230 V, 1/2-1 hp - w/20ft cord
599119 115/230 V, 1/2-1 hp - w/25ft cord
599211 115/230 V, 3/4-2 hp - w/20ft cord
This Remote Float Switch, (aka Wide Angle) is a direct-acting, in-line control system for automatically controlling wastewater, effluent, and sewage pumps. Float switch consists of one float, a cord with piggyback plug, one large mounting strap and two small adjustable mounting clamps.



LittleGIANT



599030 1" x MNPT x 3/4" GHT
599025 1-1/4" MNPT x 3/4" GHT
599026 1-1/2" MNPT x 1-1/4" FNPT
Little Giant Pump Discharge Adapters

LittleGIANT



940233 1-1/4" MNPT x 1-1/2" ID Tubing, or 1-1/4" Barbed or 1-1/2" Slip
577130 1-1/2" MNPT x 1-1/4" Barbed or 1-1/2" Slip
Check Valves

LittleGIANT



599008 115V - Piggyback with 10 ft power cord
599009 115V - Piggyback with 18 ft power cord
599019 115V - Low level w/piggyback, 25 ft cord
Converts any manual pump, up through 1/2 HP (10 max. run amps), to automatic. When mounted to 5-MSP or 6-CIM-R pump, "on" level range is 6" - 9" (15.2cm - 22.8cm), "off" level range is 1" - 4" (2.54cm - 10.2cm). Diaphragm switch



599303 1-1/4" Hose kit - 24 ft

LittleGIANT



599320
Little Giant sump pump switch repair kit. Use with 5ASP, 6CIA, 8CIA and 8CBA pumps.

LittleGIANT



950337
Little Giant VCMA pump switch. 5 amp, 250VAC. Use with VCMA-20, VCL-24ULS series pumps.

LittleGIANT



Floor drain flood guards
Steel
ULN548 3"
ULN549 4"
Brass
ULN548B 2"
ULN550 3"
ULN551 4"

OS&B



ABS body check valves
RED-22 2"
2" IPS or ABS, 2" Copper ABS Body, 4 Stainless Clamps w/Cadmium Plated Screw & Housing
RED-10 1-1/4" - 1-1/2"
1-1/4" IPS, 1-1/2" Copper, 1-1/2" IPS

Some of our most popular HVAC Pumps



550521 1/150HP, 115V, 205GPH
Little Giant Shallow Pan Condensate Pump, for removal of condensate from A/C or reservoir. screened intake, 1/4"NPT discharge, c/w 9' power cord



554401 1/50HP, 115V, 65GPH
554405 1/50HP, 115V, 65GPH
554435 1/30HP, 115V, 80GPH
554461 1/30HP, 230v, 80GPH
w/safety switch*
w/safety switch*
Little Giant automatic condensate pumps, for removal of condensate from A/C, c/w 6' power cord, 1/2gal capacity, *include 20' of 3/8"ID tubing



554530
554542 w/Anti-Sweat Sleeve
Little Giant Automatic condensate pumps, High capacity model for removal of condensate from A/C, 115V, 1/30HP, 84GPH, c/w safety switch and 6' power cord



553500 115V
553501 208*-230V
Little Giant - EC-1 Series new concept for mini pumps, noise reducing design. Easy to install. Two piece design. Normally-closed relay rated at 8 A resistive - 250 V alarm
21 dBA. 1/4" pump discharge outlet. Thermal protection: 176 °F, 60" power cable.



Little GIANT *Some of our most popular Waste Water Pumps*

<p>Water Wizard 5-ASP</p>  <p>505300 1/6 hp, 1200 gph – Submersible utility pump with piggyback diaphragm switch with 10 ft power cord, 1" FNPT w/garden hose adapter, pumps down to 1/8"</p>	 <p>WRSC-6</p> <p>506065 1/3 hp, 2750gph at 5 ft – Submersible utility pump, water removal system with 3.5 gal tank and 8 ft power cord. Pre-assembled, 1-1/2" side intake, 1-1/2" top discharge, 2" FNPT top vent</p>	 <p>WRS-5</p> <p>505055 1/6 hp, 900gph at 5 ft – Submersible utility pump, water removal system with 5 gal tank and 10 ft power cord, pre-assembled, 1-1/2" side intake, 1-1/2" top discharge, 2" FNPT top vent, c/w #5-ASP pump</p>	 <p>Big John 6-CIA</p> <p>506158 1/3 hp, 2750 gph – Automatic submersible sump pump with 10 ft power cord, 1-1/2" discharge, adapters sold separate</p>
 <p>6EC-CIA-RF</p> <p>506860 20 ft cord 1/3 hp, 3000 gph – Automatic sump/effluent pump. 1-1/2" FNPT discharge, residential and light commercial application, 20' max head</p>	 <p>ES33WI-10</p> <p>506424 1/3 hp, 52 gpm at 5 ft – Automatic submersible sump/effluent energy saving pump with wide angle float switch and 10 ft power cord. 1-1/2" FNPT discharge, residential and light commercial applications.</p>	 <p>5.5ASP</p> <p>505700 10 ft cord 505701 25 ft cord 1/4 hp, 40 gpm – Automatic Submersible sump pump with 1-1/4" FNPT discharge, incl. garden hose adapter and removable screen, operates in 7"-10" and shuts off at 2"-5", popular basement</p>	 <p>6EC-CIM</p> <p>506851 10ft cord 506852 20ft cord 1/3HP 3000gph Manual submersible light effluent sump, dewatering, water transfer, 1-1/2" FNPT discharge, residential and light commercial application, 115V</p>
 <p>9EN-CIA-RF</p> <p>509209 (9EN-CIA-RF) 4/10HP, 80GPM at 5ft</p> <p>510852 (10EC-CIA) 1/2HP, 67GPM at 5ft Effluent wastewater removal/transfer pump. Dewatering. Energy saving continuous duty, 1-1/2"FNPT, piggyback mechanical float, PSC, 115v, 20' cord</p>	 <p>2E-38NT</p> <p>502286 1/40 HP, 300 GPH – Dual Purpose Pump, 10' Power Cord. Use submersed or in-line, 1/4" MNPT discharge accepts 1/2" I.D. tubing, commercial, industrial and home applications such as fountains, water displays, a/c, machine coolants etc.</p>	 <p>508157 4/10HP, 54GPM, 115V 8 Series submersible, designed for continuous duty, 10' cord, commercial, industrial or home use</p>	 <p>I-YS</p> <p>501020 1/150 HP, 205 GPH @ 1' Parts Washer Pump – 6' Cord no plug</p>
<p>Drain a 40gal hot water tank in under 3 minutes!</p>  <p>555101 Little Giant Transfer Pump. 1/2HP, 1152GPH, 115V, 10' cord, non submersible, convenient 3/4" garden hose adapters. Also great for boosting water pressure.</p>	 <p>527003 1/40HP, 325GPH, 115V Multi-use permanently lubricated pump, for commercial, industrial or home use, 6' cord, 1/4"MNPT outlet</p>	 <p>505000 (5MSP) 1/6HP, 1200gph Manual submersible transfer or recirculation pump. Continuous duty residential, commercial or industrial use, pumps to 1/8", 1"FNPT discharge, 115v, 10' cord</p>	
 <p>9SN-CIA-RF</p> <p>509204 (9SN-CIA-RF) 4/10HP, 110GPM at 5ft 511323 (10SN-CIA-RF) 1/2HP, 120GPM at 5ft Sewage & Effluent wastewater transfer pump. Dewatering. Energy saving continuous duty, 2"FNPT, piggyback mechanical float, PSC, 115v, 20' cord</p>	 <p>360</p> <p>555112 (360) 1/10HP, 365gph Little Giant Pony Pump. Non submersible, stainless steel pump body, dual threaded intake/discharge 3/4" garden hose & 3/8"FNTP, self priming, 115v, 6' cord</p>	 <p>SP25A</p> <p>620136 (SP25A) 1/4HP, 24GPM at 5ft Basement sump pump, dewatering, water transfer. Continuous duty, oil free motor, built in suction strainer, 1-1/4"NPT discharge, 115V, 10' cord</p>	



- Energy Saver
- Residential
- Commercial
- Electrical or Gas



**We stock
Hot Water Tanks**

BRADFORD WHITE CORPORATION *Great Factories Inc.* **J.W. John Wood**
Call your nearest Amre location for brands stocked & current pricing!

81988A
 John Woods drain valve. 3/4". Used on some newer model hot water tanks, including JohnWoods.

18G0020
 Domestic hot water tank drain valve. Made out of high impact plastic.

ULN1477
 Hot Water Tank Valve For J.H. Woods, Water Heater plastic drain valve O.E.M. quality

9008023015
 JohnWoods Limit Switch. Hot water tank dual limit 195/260°C. Surface mount. Used in newer models including JohnWoods. Other styles available.

WATTS INDUSTRIES
0750160 (15-1/2) 1/2"

0750161 (15-3/4) 3/4"

Watts water hammers can be installed in new or existing systems with a standard tee vertically or at any angle.

WATTS INDUSTRIES

821555 1/2"
0009891 3/4"
0009872 3/4 X 1/2"
821557 1"
 Female X Solder dielectric unions

J.W. John Wood

58991 40G
58993 50G

JohnWoods Thermocouple thermal cut-off **conversion kit**. Used to convert **left hand thread** thermocouples used between 2008 and 2010. Includes manifold/door assembly, gas connector, janctron block adapter and ferrule

Other models available!

110-C309 N.G.
110-C319 L.P.

Robertshaws Unitrol hot water tank gas valve has been used by many manufacturers. These valves are designed for universal replacement.

Honeywell

WT8840A1000

Honeywell Water heater gas control. Standing pilot, for Bradford White models, natural gas. See website for more models

WATTS INDUSTRIES

See web for more in-stock models

0066166 (100XL-4/150) 3-1/2"L
 Watts pressure relief valve. 3/4", 150psi, 105,000 BTU/HR, M7

Screw Type

1512SIK
 1500W/115V
3024SIK
 3000W/240V

Fits most 40 Gallon brands!

93632
 Domestic hot water tank dip tube with nipple. Fits most brands, 33" length. 30g = 28", 40g = 33", 60g = 40", other sizes available!

ULN1483 42"
ULN1484 54"

Hot water heater drain tube. 3/4" male thread, plastic

0066133 (L100XL-3/150) 4-15/16"L
 Watts extended shank pressure relief valve. 3/4", 150psi, 105,000 BTU/HR, M7

Flange Type

Other wattages & styles available

1512UK
 1500W/115V
39-F3000
 3000W/240V

BRADFORD WHITE CORPORATION

224-47776-09 35.6"L
224-47776-05 38"L
224-47776-16 39.13"L
11510LC 42"L
224-47782-11 43.5"L
224-47776-12 47.1"L

Bradford White water heater magnesium anode rod. 3/4"NPT nipple.

Oatey

34143 Plastic
34083 Alum. w/drain

Oatey hot water heater pan. Protect from water damage. 24"D

WR

755-1
 White Rodgers Universal water heater thermostat. SPST, open on rise

TH3ZX006 DPDT x DPST
 Combo thermostat with high limit.

New!

39-T3
 Universal water heater adjustable thermostat. DPST, high-limit at 180°F

See page 248 for a wide selection of thermocouples and thermopiles!





GFC530V
 - 1/2HP Deluxe
 - Continuous feed
 - Extra-large capacity disposer
 - 2800rpm
 - EZ mount
 - S.Steel anti-jam grinding blades



GFC525V
 - 1/2HP Deluxe
 - Continuous feed
 - Large capacity disposer
 - 2800rpm
 - EZ mount
 - S.Steel anti-jam grinding blades



WPGC5000XEA
 - 3/4 HP Motor
 - Continuous-Feed
 - 1,725 RPM
 - ABS Grind Chamber
 - Stainless Steel Shredder Ring,
 Sink Flange and Stopper
 - 1 Year Warranty



WPGC2000XEA
 - 1/2 Horsepower Motor
 - Galv. steel grinding wheel &
 shredder ring
 - S.S. sink flange w/1-pc. plastic
 stopper
 - 2 Year Warranty



WPGC1000XEA
 - 1/3 Horsepower Motor
 - Overload Protector with Manual
 Reset
 - Dishwasher Drain Connection
 - Continuous-Feed Operation
 - 1 Year Warranty



BADGER444
 - 3/4HP Dura-Drive
 - Quiet Dura-Drive induction motor
 - Stainless Steel grinder assembly
 - Quick Lock easy install
 - 4yr in-home warranty.



BADGER5
 - 1/2 HP Induction Motor.
 - Rugged galvanized steel constr.
 - Quick Lock easy install
 - Quiet Dura-Drive induction motor
 - 2 Year In-Home Warranty.



BADGER1
 - 1/3HP Induction Motor.
 - Rugged galvanized steel constr.
 - Quick Lock easy install
 - Quiet Dura-Drive induction motor
 - 1 Year In-Home Warranty.



PLM12T Lemon
PCO12T Orange
 Garbage disposal
 cleaner and deodorizer.



SMG-OO
 Badger1,5,444,Pro333
DMG-OO
 555SS,777SS,ProSS,Pro77
 Insinkerator mounting gasket



1027
 Universal Splash Guard &
 Stopper.



8219-A
 Insinkerator tail pipe, gasket sold
 separate #1470.



STP-PL Black plastic
 Insinkerator Stopper, Fits all
 Insinkerator models, other finishes
 available.



CRD-OO
 Three-foot cord, strain relief
 clamp and wire connectors.



65080
 Dishwasher drain adapter.



WRN-OO
 Insinkerator hex wrench. Used to
 free jammed ISE disposers.

Commercial Laundry



27-1040-100
 \$1 COIN ONLY, PRESET @ \$1.00
 Tokette models available, Special Order now a coin
 chute that fits all brands including Maytag (205470)

11-1111 Tokette Slide I (Large)
 Greenwald Tokette I Chute System is Terrific for Collection
 Protection, Operation Versatility and Increased Revenue.

77-83-8 8" Long
 Coin Chute Bolts

Do you manage your own laundry equipment?

Amre Supply is an authorized distributor for several coin management
 manufacturers. We can assist with complete chute replacements,
 security guards and coin box replacements,
Call us today!



11-5010-15
 Tokette II (Small) Green
 1000/pack.
11-5020-1
 Tokette I (Large) Black
 1000/pack.

*Amre Supply requires proof of property
 ownership for the purchase of any tokens.
**These must be purchased in person,
 proper ID and account required****

COIN BOXES



Authorized Parts Distributor



Great space savers!



Danby

Looking for apartment sized appliances?
We can help you find the perfect appliances!
Danby has refrigerators and stoves
specially designed to fit every sized space.



FFET1222QW

- 12 Cu. Ft. Top Freezer, 24"W
- Apartment-Size Refrigerator
- Frost Free, Reversible doors
- Store more door bins
- Clear crispers drawers
- Bright lighting

Approx. Dimensions (in.):

24" W x 28-3/4" D x 59-7/8" H

also available in SS



Contact us for:

- Wholesale pricing
- Delivery Services
- Job Quotes

FRIGIDAIRE



FFHT1514TW

- 14.5 Cu. Ft. Top Freezer Refrigerator, 28"W
- 2 Full-Width Wire Sliding Shelves
- 2 Clear Crispers
- 2 Humidity Controls
- Store more door bins
- Reversible doors

Approx. Dimensions (in.):

28" W x 29-7/8" D x 60-5/8" H

also available in SS



FFHT1614TW

- 16.3 Cu. Ft. Top Freezer Refrigerator, 28"W
- 2 Full-Width Wire Sliding Shelves
- 3 Full-Width Fixed Door Racks
- 2 Clear Crispers
- 2 Humidity Controls
- Reversible doors

Approx. Dimensions (in.):

28" W x 29-7/8" D x 65-1/8" H

white only



FFHT1821TW

- 18 Cu. Ft. Top Freezer Refrigerator, 30"W
- 2 Full-Width Glass Sliding Shelves
- 3 Full-Width Fixed Door Racks
- 2 Clear Crispers
- 2 Humidity Controls
- Reversible doors

Approx. Dimensions (in.):

30" W x 30-1/8" D x 66-1/8" H

also available in black and SS



FRIGIDAIRE

Frigidaire Appliances
NOW available!

Appliance



Range



Contact us for:

- Wholesale pricing
- Delivery Services
- Job Quotes

24"

FRIGIDAIRE

Microwave



CFEF2411RW

- 24", 1.9 cu.ft. Capacity
- Front Controls
- Coil Top
- 4 Burners (2 SM, 2 LG)
- Manual Clean
- Fan Convection

Approx. Dimensions (in.):

24" W x 25 1/2" (incl. handle) D x 36" H
white only



CFEF2422RS

- 24", Radiant, 1.9 cu.ft. Capacity
- Front Controls
- Smooth Top
- 4 Burners (2 SM, 2 LG)
- Manual Clean
- Fan Convection

Approx. Dimensions (in.):

24" W x 25 1/2" (incl. handle) D x 36" H
Stainless Steel only



CFMV1645TW White

CFMV1645TB Black

CFMV1645TS Stainless Steel

- 1.6 Cu. Ft. OTR, 1000W
- 2 speeds Exhaust Fan, 105/220 CFM
- Grease and Charcoal Filter
- Auto Defrost and Reheat
- LED Light
- Extra Large turn table

Approx. Dimensions (in.):

29-7/8" W x 15-1/4" D x 16-13/32" H

30"



CFEF3012TW

- 30" Free Standing, 4.9 (Cu. Ft.)
- Electric
- Coil Top, digital clock/timer
- 4 Burners (2 SM, 2 LG)
- Manual Clean
- Large Window

Approx. Dimensions (in.):

29-7/8" W x 28-1/2" D x 46-5/8" H
white only



CFEF3056TW

- 30" Freestanding, 5.4 (Cu. Ft.)
- Electric, digital clock/timer
- Smooth Top w/convection oven
- 5 Burners (2 SM, 2 Dual 6/9" & Warming zone)
- Self Clean
- 6 Positions Oven rack, large capacity

Approx. Dimensions (in.):

29-7/8" W x 29-1/4" D x 47" H
also available in Stainless Steel

New!



CFEF3055TS

- 30" Freestanding, 5.3 (Cu. Ft.)
- Electric, digital clock/timer
- Smooth Top
- 4 Burners (2 SM, 1, LG & 1 Dual 6/9")
- Self Clean
- 6 Positions Oven rack, large capacity

Approx. Dimensions (in.):

29-7/8" W x 28-13/32" D x 47-3/4" H
also available in White & Black



Contact us for:

- Wholesale pricing
- Delivery Services
- Job Quotes



Dishwasher 18"



FFBD1821MW

- Built-In, ADA Compliant, 18"W
- Hi-Temp Wash, Easy touch controls
- Multiple Cycles
- Stainless Steel Interior
- 4 Wash Levels, Ultra Quiet III

Approx. Dimensions (in.):

17-5/8" W x 23" D x 32-1/2" - 34-7/8" H
also available in SS

Dishwasher 24"



FFBD2408NW

- Tall Tub Built-In
- 4 Cycles, Ultra Quiet I
- 5 Wash Levels
- Easy touch controls
- Plastic Interior

Approx. Dimensions (in.):

24" W x 25" D x 33-1/2" - 35" H
also available in SS



FFID2426TS

- Tall Tub, Built-In
- 4 Cycles, Ultra Quiet IV
- 5 Wash Levels
- Top of door controls
- Plastic Interior

Approx. Dimensions (in.):

24" W x 25" D x 33 1/2 - 35" H
Stainless Steel only

Laundry

EFLW417SIW

- 5.0 Cu.Ft Front Load Washer
- Stainless Steel Drum
- Large Capacity, 7 Cycles
- LuxCare Wash System

Approx. Dimensions (in.):

27" W x 32" D x 38" H



FRIGIDAIRE



Pedestals and stacking kits sold separately.

EFMC417SIW

- 8.0 Cu.Ft Front Load Electric Dryer
- 7 Dry Cycles
- Perfect Steam wrinkle release option
- Reversible Door

Approx. Dimensions (in.):

27" W x 31-1/2" D x 38" H



GTW220BMKWW WASHER

- GE 4.4 cf.
- 4 Water Levels
- Gentle Power Agitator
- Rotary Electromechanical Controls
- Multiple Wash/Rinse Temperatures

Approx. Dimensions (in.):

26-7/8" W x 26-5/8" D x 43-1/2" H



GTX22EBMKWW DRYER

- 6.2 cf Electric Dryer
- Dura Drum interior
- 3 Cycle
- Long vent capability
- End-of-cycle signal
- Auto Dry

Approx. Dimensions (in.):

26-7/8" W x 26-3/4" D x 42-5/8" H



GUD24ESMJWW

- Unitized Spacemaker Washer & Electric Dryer
- 2.4 cu.ft. Washer, 4.4 cu.ft. Dryer

- 3 Wash/Spin Combos
- 4 Heat Selections
- 5 Water Levels
- 9 Wash cycles
- Quiet Design

Approx. Dimensions (in.):

74-1/2 H x 24 W x 27-1/4 D



GUD27ESMJWW

- Unitized Spacemaker Washer & Electric Dryer
- 3.7 cu.ft. Washer, 5.9 cu.ft. Dryer

- 3 Wash/Spin Combos
- 4 Heat Selections
- 5 Water Levels
- 9 Wash cycles
- Quiet Design

Approx. Dimensions (in.):

75-1/2 H x 27 W x 30-13/16 D



Bottle Bars . End Caps

- 240535101** 23"W x 4-1/2"D
- 240535201** 23"W x 6"D
- 240535301** 14"W x 4-1/2"D
- 240535001** 23-1/8"W x 4"D
- 240534701** 24-1/2"W x 6"D
- 240534901** 24-3/4" x 4-1/2"D

Frigidaire Refrigerator door bar. White. Note: Not all are as shown, end styles may vary slightly, check model before ordering.



- 240337901**
Frigidaire Refrigerator door bin white, 26"W x 7"D

- 240338001** 6"D
- 240338101** 5"D
- Frigidaire Refrigerator door bar. White. 24-1/2"W

- 240331401**
Frigidaire Refrigerator door bottle bar, 20-1/4"L x 1-3/4"W

240363702 Frigidaire Refrigerator door shelf bin, clear, 15"W x 6"D	240323002 Frigidaire Refrigerator door shelf bin, clear	3206150 RH 5303324302 LH Frigidaire Shelf Support	3206165 Right 3206166 Left Frigidaire Bottle Bar End Caps	215267701 Frigidaire Shelf Support Rail cap, left or right

New!

1Gal 2Gal 240331502 Right - 1G 240331501 Left - 1G 240311502 Right - 2G 240311501 Left - 2G Frigidaire Shelf Support	241872501 Freezer Door 241872502 Main Door Frigidaire fridge door gaskets. Check model before ordering.	PRO PICK 40A15CL Clear 40A15F Frosted Most popular appliance lamp. 40w, med base, 120v.	Handles 218428101 Frigidaire Refrigerator door handle white	New! WG03L01397 GE Refrigerator door handle set, white

5304506469 White 5304506471 Black Frigidaire Refrigerator Handles.	819342 Whirlpool Refrigerator handle end cap kit, chrome	240337103 Frigidaire Refrigerator crispener drawer clear	240397701 Frigidaire Refrigerator crispener pan	240364501 Frigidaire Refrigerator crispener drawer

Crispers

WG03L00764 G.E. Refrigerator cover vegetable pan, 24-1/8"L x 18-3/4"W	240350608 Frigidaire fridge crispener cover. 23-3/4"W x 15-5/8"D.	240530701 RH 240530601 LH Frigidaire Refrigerator drawer slide rail	5304470332 Frigidaire Refrigerator defrost timer.	242077702 Frigidaire Refrigerator evaporator fan motor

New!

90-RT621 (CC922) Universal Refrigerator defrost timer, 6hr 21min.	215846602 Frigidaire Refrigerator Defrost Timer. 8 hour 30 minute timer.	New! W10311524 Whirlpool Refrigerator Fresh Flow air filter	JE539 Universal Refrigerator defrost timer, 6hr 21min.	PART # DEGREES ML45 45deg ML50 50deg ML55 55deg ML60 60deg ML70 70deg Defrost thermostats. 36" lead length, replaces most switches used in Canadian refrigeration

5303918202 Frigidaire Refrigerator defrost thermostat (L47-22)	WPW10392132 Whirlpool Defrost thermostat, clip on face.	WG03F05834 G.E. Refrigerator evaporator motor AC/DC	5303918549 Frigidaire Refrigerator evaporator motor assembly	



Trust AMRE for
quality OEM
replacement parts!

blocks . controls . elements

Range



elements



Best Sellers

PS-12-4 (38-812)
Multi brand surface element
6"/1250W

38-815 (PS-15-4)
Multi brand surface element
6"/1500W

PS-21-4 (38-821)
Multi brand surface element
8"/2100W

38-824 (PS-24-4)
8"/2400W Surface Element Large

38-826 (PS-26-4)
Multi brand surface element
8"/2600W



Best Sellers

P1T15F (38-140)
G.E./Camco surface element
6"/1500W

P1T23F (38-151)
G.E./Camco surface element
8"/2400W



Notched

WG02F05371 6"/1500W
WG02F05390 8"/2400W
G.E. Range element, 3 leg



318372210 6"/1250W
316439801 6"/1500W
316442300 8"/2100W
316442303 8"/2400W
316442301 8"/2600W
Frigidaire Range surface element. Use rept. #318112500



Notched/ Crantée

WG02F05354 6"/1500W
WS01F02289 8"/2600W
G.E. Range surface element. Use
receptacle WG02F05807



WPY04100165 (MP15MA)
Maytag/Jennair Delta Frame surface element
6"/1250W

WPY04100166 (MP21MA)
Maytag/Jennair Delta Frame surface element
8"/2100W



New!

WP660532 6"/1500W
WP660533 8"/2600W
Whirlpool Range Surface
element, use block 330031

receptacles



WG02F05806
G.E. Range surface element recep-
tacle. Use with PS-12-4, 38-815,
PS-21-4, 38-826 etc...



WG02F05815
G.E./Camco Range surface element
receptacle, use with P1T15F &
P1T23F



WG02F05807
G.E. Range Surface Element Re-
ceptacle. Use with WG02F05354,
WS01F02289



5303935058
Frigidaire Range Surface Element
Receptacle



Best Sellers

318112500G
Frigidaire Replacement Range
surface element receptacle. Will fit
most brands. Use with PS-12-4, 38-
815, PS-21-4, 38-826 etc...



12001676
Whirlpool Range receptacle kit,
includes ceramic block, (2) brackets,
wire nuts and instructions. Use with
WPY04100165, WPY04100166



330031
Whirlpool Range Surface Element
Receptacle

24 HR.



Order by
4pm for 24-48hr shipping
to almost anywhere in
Canada!

switches



318120500
Frigidaire Range infinite
switch. 6" or 8".



6500-208
Multi Brand Infinite Range Surface
Element control switch, 6" or 8", Shaft
position at "OFF" -up/down



6500-209
Multi Brand Infinite Range Surface
Element control switch, 6" or 8", Shaft
position at "OFF" -right/left



318293810
6"/1296/1680W

318293811
8"/2136/2640W
Frigidaire Range surface element switch.



WP9758060
Whirlpool Range infinite burner switch

WP9750646
Whirlpool Range surface element
switch. 2100/2600W



316436000
1250-1500W
316436001
2100-2600W
Frigidaire Range surface burner
infinite switch.



WP9750641
Whirlpool Range
infinite burner switch.
2100/2600W



WP3149400
Whirlpool Range Surface Element
Switch.



WG02F00292
1560W
WG02F04192
2600W
G.E. Range infinite burner switch



WG02F05772
8"/2600W
G.E./Camco Range Surface Element
Control



bowls



CRP6 6"
CRP8 8"
1-7/8" Range Chrome bowl/ring



WG02F05008 6"
WG02A00675 8"
1-7/8" Range Porcelain/Black bowl/ring



CP6E 6"
CP8E 8"
1-3/8" Range Porcelain/Black bowl

Frigidaire



A316222201 6"
A316222301 8"
1-3/4" Range Porcelain/Black bowl/ring



5303935055 6"
5303935053 8"
Frigidaire Range Black bowl/ring



316048414 6"
316048413 8"
Frigidaire Range Chrome bowl/ring

GE



WG02L01429 6"
WG02L01430 8"
1-7/8" GE Range black bowls

24 HR.



Order by
4pm for
24-48hr shipping
to almost anywhere in
Canada!

Whirlpool/Universal



W10196406RW 6"
W10196405RW 8"
1-3/4" Whirlpool Range drip bowl chrome

Will work for many brands.



Will work for many brands.

WPW10290353 6"
WPW10290350 8"
1-3/4" Whirlpool Range drip bowl black.

Common - Rings



CR6 6"
CR8 8"
Range Trim Ring chrome



with clips

CRC6-10 6"
CRC8-10 8"
GE Range Chrome rings

Oven Knobs & Misc. Parts



RK100 Black
Range surface element knob kit (4) Incl. 20 colored inserts.



RK101 Black
Range electric oven control knob. Includes all colored inserts.



318017110 White
Frigidaire Range control knob.



RCHR
Range Surface Element Centers 4/pkg Chrome



WG02L01898
G.E. Range Surface Element Medallion in Chrome.



316455400
Frigidaire Oven Range control board

New!



318025314 23"W x 15"L

316067902 23"W x 16"L
Frigidaire Range oven rack.

New!



316239700
Frigidaire Oven Range door gasket seal. 52"L x 1/2"W



318053301
Frigidaire Range door seal (gasket) with clips.



1374-1 Black
1374-1W White
Range accessory 3 wire outlet, 15A.



814229
Whirlpool Range Drawer Roller Kit





**Do-it-yourself
Video Library**

100's of repair videos are now online! Search for help on particular repairs & installations.

www.amresupply.com



GE

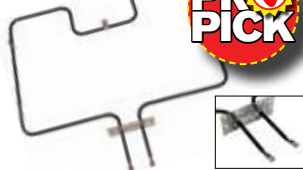

UB642 (3000W/240V)
G.E./Camco Range bake element.
18.50"W x 14.55"L x 3.875" insert
(WB44M147, RB147)



UB640 (2400W/240V)
G.E./Camco Range bake element.
13.00"W x 14.00"L x 3.875" insert.
(WB44M164)

Over 100 Bake & Broil Element Styles Instock!

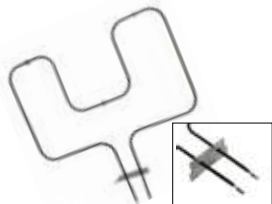

WG02F05396 (3000W/240V)
G.E. Range bake element.
18.0"W x 16.0"L x 4.0" insert

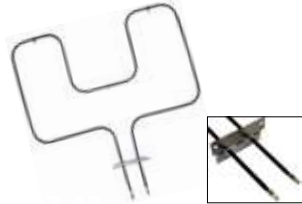

UB639 (3000W/240V)
G.E. Range bake element.
18.50"W x 15.0"L x 4.0" insert



WS01F02247 (2585W/240V)
G.E. Range bake element.
18-1/8" W X 15-3/4" L X 2-3/8" insert



WG02F05470 (3000W/240V)
G.E. Range broil element.
12.75"W x 16"L x 4" insert

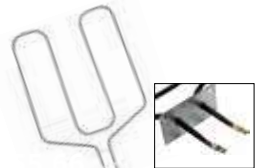

WS01F02162 (2565/3410W)
G.E. Range Broil Element
14.5"W x 16.5"L x 2.6" insert



WP74010750 (2585W/240V)
Maytag Range bake element.
23-5/8"W X 15-3/8" L X 3-3/8" insert



WP7406P428-60 (2585W/240V)
Maytag Range bake element.
18-7/8"W x 15-7/8"L x 3-1/4" insert



WP74003019 (2800W/240V)
Maytag Range bake element.
19.0"W x 19.0"L x 3.5" insert

Whirlpool

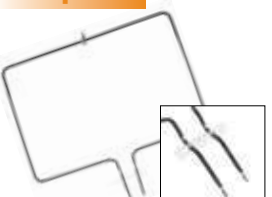

W10779716 (3600W/240V)
Whirlpool Range bake element.
20.50"W x 16.75"L x 3.5" insert



WP9780993A (2500W/240V)
Whirlpool Range broil element.
14.5"W x 16.75"L x 2.5" insert



WP9750213 (2500W/240V)
Whirlpool Range bake element.
19.0"W x 15.5"L x 2.5" insert

24 HR.



Order by
4pm for
24-48hr shipping
to almost anywhere in
Canada!

Universal

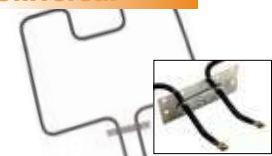

UB482 (2500W/240V)
Universal Range bake element.
15.55"W x 14.55"L x 3.875" insert

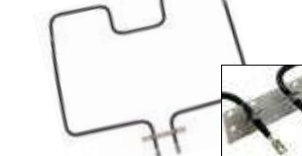

UB593 (3000W/240V)
Universal Range bake element.
17.50"W x 15.05"L x 1.875" insert



UB592 (2500W/240V)
Universal Range bake element.
17.50"W x 15.05"L x 1.875" insert



UB474 (2500W/240V)
Universal Range bake element.
15.55"W x 14.55"L x 1.875" insert

New!



UT096 (3000W/240V)
Universal Range Broil Element.
11.00"W x 14.00"L x 1.875" insert



UT095 (3000W/240V)
Universal Range Broil Element.
11.00"W x 14.55"L x 1.875" insert



UB732 (3000W/240V)
Universal Range bake element.
19.25"W x 15.55"L x 1.875" insert



Need help finding your
parts? Look up your model at
www.AmreSupply.com or call
1-800-661-9891

Any brand . Any Part We stock over 100,000 parts



Appliance





Range

bake . broil . elements . receptacles

Over 100 Bake & Broil Element Styles Instock!

Universal



UB323 (3000W/240V)
Universal Range bake element.
13.00"W x 16.55"L x 1.875" insert

Frigidaire



318255001 (2500W/240V)
Frigidaire Range bake element.
15"W x 15.25"L x 4" insert



UB813 (2500W/240V)
Frigidaire Range bake element.
20.25"W x 14.5"L x 1.88" insert



UB822 (3000W/240V)
Frigidaire Range bake element.
20.25"W x 16.55"L x 1.875 insert

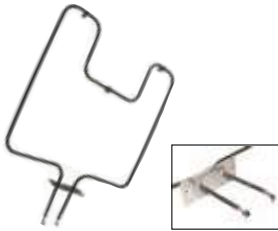

318255006 (3000W/240V)
Frigidaire Range replacement bake element.
20"W x 15.5"L x 4.00" insert.



316075104 (1950/2600W/240V)
Frigidaire Range bake element.
19.50"W x 18.50"L x 3.50" insert



318254906 (3400W/240V)
Frigidaire Range bake element.
20"W x 19.25"L x 3.0" insert



318255605 (2750W/240V)
Frigidaire Range Broil Element.
12"W x 19.5"L x 3.5" insert



5303051519 (2600W/240V)
Frigidaire Range bake element.
19.5"W x 15.6"L x 3.1" insert

2-1/8" Deep



BC72171-K
4-11/16" Square. Range & Dryer Box,
2-1/8"D



45126
Flush Mount Range Receptacle, 3
pole, 4 wire, grounding
50A/120-240V Nema 14-50R



45125
Flush mount Dryer Receptacle, 3
pole, 4 wire grounding 30A/120-
240V Nema 14-30R



4396923
Range Porcelain Broiler Pan and Grid



544150 (5434/802)
Dryer Cord. 1.98 Meters (5')
DRT10/3-12/1, 30 AMP, 250 Volts



544147 (5436/802)
Range Cord. 1.98 Meters (5') DRT8/3-
10/1, 40 AMP, 250 Volts

24 HR.



Order by
4pm for
24-48hr shipping
to almost anywhere in
Canada!



2003501010
Multi Brand range lamp socket -
Porcelain

GP Fuses

- Type P, Screw In
- GP15** 15 Amp
- GP20** 20 Amp
- GP25** 25 Amp
- GP30** 30 Amp

**For Best Pricing Order in
Boxes of 50**

40A15CL
40 Watt, Clear lamps



40A15F
40 Watt, Frosted lamps





Rangehoods

BP Series (available in 24" & 30") Basic Performance Series

• Convertible for vented (3-1/4" x 10" or 7" round ducting) or Non-ducted* operation



- 180 @ 7.5 Sones
- Built-In covered light
- Convenient front rocker switches
- Easy installation
- Dishwasher-safe aluminium grease filter
- 1.7 Amps / 120 Volts

BROAN

24" Models Ducted/Non Ducted*

- BP124WHN White
- BP124ALN Almond
- BP124BLN Black
- BP124SSN Stainless Steel

*Non Ducted Operations require an odour reducing charcoal filter. Sold separately, FKM65

30" Models Ducted/Non Ducted*

- BP130WHN White
- BP130WWN White/White
- BP130ALN Almond
- BP130BLN Black
- BP130SSN Stainless Steel



New!

Please Note:

"BP series" hoods will be replaced by "BU series"

BU Series (available in 24" & 30") Under Cabinet Series

- Convertible for vented (3-1/4" x 10") or Non-ducted* operation
- 160 @ 6.5 Sones
- Built-In covered light
- Convenient front rocker switches
- Easy installation
- Dishwasher-safe aluminium grease filter
- 2.5 Amps / 120 Volts



*Non Ducted Operations require an odour reducing charcoal filter. Sold separately, 41F

BROAN

VEEDER

24" Models Ducted/Non Ducted*

- BU224WH White
- BU224SS Stainless Steel

30" Models Ducted/Non Ducted*

- BU230WH White
- BU230WW White/White
- BU230BL Black
- BU230SS Stainless Steel



Filters

PART#	BRAND	FILTER	PKG/SIZE	MODELS
RF38A	Broan	Grease	8-3/4" x 10-1/2" x 1/8"	48000 * Fits NEW BU Series
RF49CB	Broan	Charcoal	7-1/2" x 8-1/2" x 3/8"	48000
41F	Broan	Charcoal	8-3/4" x 10-1/2" x 3/8"	* Fits NEW BU Series
RF56A	Broan	Grease	10-5/8" x 11-3/4" x 3/8"	58000
RF39C	Broan	Charcoal	8-3/4" x 10-1/2" x 3/8"	48000
FKM65	Broan/Nutone	Charcoal	8-7/16" x 11-1/4" x 3/8"	BP/RL
RLSM65	Broan/Nutone	Grease	8-1/2" x 11-1/2" x 1/8"	BP/RL
BPSF30	Broan/Nutone	Charcoal	(2/pkg) 10-13/16" X 13-5/16" x 3/8"	WS/QS 130, 230 & 330
BPS1FA30	Broan/Nutone	Grease	(2/pkg) 11-3/4" x 14-3/4" x 3/8"	WS130, QS130
BPS2FA30	Broan/Nutone	Grease	(2/pkg) 11-3/4" x 14-1/4" x 3/8"	WS230, QS230
BPS3FA30	Broan/Nutone	Grease	(2/pkg) 11-7/8" x 14-3/8" x 3/8"	WS330, QS330
RFQTC	Broan /Nutone	Charcoal	11-1/4" x 12" x 3/8"	WA & QT Series
RFQTA	Broan/Nutone	Grease	11-1/4" x 12" x 3/8"	WA & QT Series
K0793000	Broan/Nutone	Grease	8-7/16" x 11-1/4" x 3/8"	LL6, MM6, VL6 Series
6802A	Whirlpool	Grease	5-5/16" X 13-3/8" x 3/32"	Various Models
W10208631A	Whirlpool	Grease	5-7/8" X 13" X 3/32"	Various Models

Grease



Charcoal



Best Sellers

Filters

For a complete listing please check out www.amresupply.com or our new Appliance Online Catalogue

RANGEHOOD MOTORS/BLADES



T1-R610
Broan/Nutone/Air King Range Hood motor only.
0.7A, 120V, Stack = 0.875"
Shaft = 7/32" X 1.2" with c-groove
2400 RPM, 2 SPD



T1-R3101 (LL6100) CW
Nutone Range Hood motor only.
0.7A, 115V, Stack = 0.98"
Shaft = 7/32" X 1.6"
3000 RPM, 2 SPD



10941066
Broan Rangehood Motor Assembly.
2 speed w/bracket and blade. Fits most brands of basic hoods incl 48000/54000/RL61F/5L/BP series

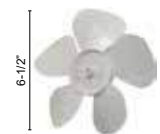

FB660 25° pitch (high vol.) (K4417000, 30020091)

FB665 12° pitch
Broan/Nutone Rangehood blade models 48/5455/57/58/65000 and more



99030342 Black
99030343 White
Range hood rocker light switch. On-Off, 2 Wire.



99030347 Black
99030348 White
Range hood rocker fan switch. 2 speed, 3 Wire.

Amre stocks replacement parts for all brands of range hoods!





High Pressure Rubber

Quality washer inlet hoses. 3/8" inside diameter, Burst test to 800PSI cold and 600PSi Hot. Double crimped ends provide added fitting strength.

Female X Female

- 3804FF (104FF) 4'
- 3805FF (105FF) 5'
- 3806FF (106FF) 6'
- 3808FF (108FF) 8'
- 3810FF (110FF) 10'
- 3812FF (112FF) 12'
- 3815FF (115FF) 15'



- 3805FFB-2 5ft
- 3806FFB-2 6ft

Quality washer inlet hose kit. Comes with 2 rubber hoses, 2 hose screen washers and 2 neoprene washers.



Color Coded Washer Inlet Hose Kit

- 3805FFB-2RB 5ft
- 3806FFB-2RB 6ft

Reinforced rubber hose stays flexible. Easy to identify red for hot and blue for cold. Includes 2 hoses and washers.

- 3237-480 48"
- 55522 60" Lyncar
- 41028 60" EZ-Flo



237-720 72"

Quality Stainless steel braided washer inlet hoses. 3/4" Female x Female. Rough brass nuts. Washers included.



55598 60"

Premium braided oversized washer hose with 90° end. Increased flow rates, PVC inner hose with SS#304 braided, won't kink or crease. 3/4" female garden hose thread. CSA approved

washer



18-066 (66FCW) Hose washers with fine screen. Sold individually



ULN531RW 12/pkg. Rubber hose washers.



18-300 (GSW300) 100/pkg. Hose washers. Green Stripe black neoprene specifically designed for wash machine hoses.



HYP38 "Y" style mixer hose. 2 x Female 3/4" to 1 Male 3/4" garden hose fittings.



CHLESS-15 18kg Citro Laundry Detergent



W10135699 3/pk Affresh Washer Cleaner Pucks. Removes and prevents odor causing residue.

Universal



SSD-6GE 6ft Washer heavy duty poly drain hose with GE (A) male connector. 1", 1-1/8", 1-1/4"



SSD6 6ft SSD-8 8ft Universal washer drain hose. Heavy duty poly. 1-1/4" full inside diameter. 7/8" to 1-1/8" connector.

GE



WG04F04600 54"L G.E./Camco Washer drain hose.

Whirlpool



285664 48" Whirlpool Washer drain hose. Newer style, hook swivels 360 degrees.

Frigidaire



131461200 90"L Frigidaire Washer drain hose. Elbow incorporated to fit pump.





W10288149B 3/pk
Affresh Dishwasher Cleaner
 Tablets help remove even the most stubborn odours from dishwashers. Fresh up to a month



807117001 96"L
 Frigidaire Dishwasher drain hose.
 45° pump connector.



154225602 120"L
 Frigidaire Dishwasher drain hose.
 90° pump connector.



WG02F04149 79"L
 G.E. Dishwasher drain hose.



WPW10545278
 Whirlpool Dishwasher drain hose.



8269144A Straight 78"L
 Whirlpool Dishwasher drain hose.



3241-480 48"
3241-600 60"
3241-720 72"
 Stainless steel braided dishwasher supply line. Comes complete with both old and new style elbow fittings



6868-U
 1 1/2" X 8" Dishwasher Tailpiece.,
 Universal C/W Washers



3850A-6 6"
3850A-8 8"
 Dishwasher tailpiece. Rough brass.
 1-1/2" x 20ga.



3270-600 60"
3270-720 72"
 Dishwasher Installation Kit.
 Includes 1 stainless steel supply line, ABS DW "Y", push-fit shut-off valve, 2 elbows, 3/8" MIP and 3/4" GDN hose, teflon and removal tool, push-fit fits copper/CPVC and pex

Q437 Sold individually
 Tailpiece flanged poly washer. 1-1/2".



VI3460
 New style dishwasher brass elbow.
 3/8" comp. x 3/4" Female.



U2276LF
 1/4" X 3/4"
 Garden hose nut, dishwasher elbow,
 push on



U3523LF
 Stop Valve Connector Converts 3/8"
 compression to Sharkbite 1/4" (3/8"
 OD) X 3/8" compression nut 1/4" X
 9/16"- 24 UNEF Thread



70500
 Dishwasher 90deg brass elbow. 3/8"
 comp. x 3/8" MIP.



ULN299A
 3/8" Fem. 3/8" X 3/8"

ULN299
 3/8" Fem. 3/8" X 1/4"
 Piggy back "T" adapters. Easy way
 to add an outlet for dishwasher,
 icemaker or humidifier.



65080 (DW804)
 Disposal/Dishwasher step down hose
 adapter. 5/8", 3/4", 7/8", and 1"



24983CA
 1/2" X 1/2" X 1/4" COMP
24984CA
 1/2" X 1/2" X 3/8" COMP
 Sharkbite Tee Stop. Simple installation
 for icemakers, humidifiers, dish-
 washers and more. Copper, CPVC,
 PEX to Compression fitting



NEW
Appliance Repair
Videos

We have added hundreds of
Do-It-Yourself
appliance repair videos
 to the AMRE website!





Dishwasher

common parts

Call us with your model #!
We have the parts you need in stock!



5304442173 White
5304442175 Black
Frigidaire Dishwasher latch and gasket kit



154574401
Frigidaire Dishwasher Detergent Dispenser

New!



154388801
Frigidaire Dishwasher rinse aid cap



154637401
Frigidaire/D&M Dishwasher water inlet valve.



WG03F00838
G.E. Dishwasher water inlet valve.



WG04F01376
G.E. Dishwasher water inlet valve.

WG04L01888
G.E. Dishwasher Drain Pump Shaft Seal.



WP9750343
Whirlpool Dishwasher Indicator Light Lens.



WG04F00655
G.E./Camco Dishwasher pump and motor assembly.



154567702 with Pop Up
154568002 no Pop Up
Frigidaire/D&M dishwasher 1998 to present lower spray arm, sidewinder pump spray arms



WG04A00064
G.E. Dishwasher lower spray arm assembly.

New!



WPW10158389
Whirlpool Dishwasher water inlet valve



154844301
Frigidaire Dishwasher pump and motor assembly.



W10195416V
Whirlpool Dishwasher lower dishrack roller assembly



5300809640
Frigidaire Dishwasher lower rack roller with axle.



WG02F02960
G.E. dishwasher lower dishrack roller wheel and axle



WG04L00442
G.E./Camco Dishwasher Rack Roller Front



WG04A03477
G.E. Dishwasher lower rack wheel and studs, 8/pk

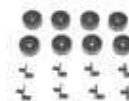

WG04A03392
G.E. Dishwasher stub roller assembly, 8/pk

New!



W10712394
Whirlpool Dishwasher upper dishrack adjuster, 2/pk



154430601
Frigidaire dishwasher door spring



154430501
Frigidaire dishwasher door spring

New!



8194001
Whirlpool Dishwasher door balance kit



154701001
Frigidaire Dishwasher splash shield kit



WG04F01565 RH
WG04F00036 LH
G.E. Dishwasher corner tub baffle.



809006501
Frigidaire Dishwasher bottom door gasket.



154827601
Frigidaire Dishwasher tub gasket



WG04L00216
G.E. Dishwasher door gasket

New!



W10807920
Whirlpool Dishwasher cutlery basket



is the preferred brand
of dryer ducting by most
Fire Departments!



ProFlex

PRO PICK

- BTD48** 4" X 8' Length
- TD425** 4" X 25' Length
- TD450** 4" X 50' Length

U.L. Approved, Listed and Marked 4 Ply Heavy Duty Aluminium Foil Ducting. Fire Resistant Aluminium foil encompassing a corrosion resistant wire helix
Uses: Specifically engineered and designed for exhausting gas and electric clothes dryer



- MFX48X** 4" X 8' Length
- MFX410X** 4" X 10' Length
- MFX425X** 4" X 25' Length

Aluminium metallic ducting, airtight, flame resistant, water resistant & has a temperature range of -74°C to +224°C. Recommended by most manufacturers for gas dryers and range hoods.



MFX48D2DZW 4" X 8' Length
Dundas Jafine Semi-Rigid Dryer Duct Connector Kit. Contains Semi Rigid flexible all Aluminum Duct, elbow and extension piece.



MFX48ULMK 4" X 8' Length
Dundas Jafine Heavy Duty Universal Dryer Hook-Up Kit, All metal. Installs electric or gas dryer properly, safely, and easily.



MC4ZW
4" Metal Clamp Screw Type



DC4ZW 4"
Dryer hose lint cleaner union.



P4E
4" X 24" X 0.012 Aluminium Vent Pipe



E432
4" x 90° Aluminium Elbow



BPCK
Dryer Cleaning Kit. Includes 10' duct brush, 36" lint trap brush and vacuum hose attachment.



PCPBZW
Drill powered duct cleaning brush. Extends up to 8', 90deg flexible.



PBH50WZW White
Pest guard. Secured with screws over most 3" or 4" vent caps.



BLH4WZW 4" White
Exhaust hood. Provent 4" Dryer Vent Hood, White



LH4WXZ 4" - White
Louvered Hood with 12" Tailpipe
LC4WXZW 4"
Louvered exhaust cap only



PVB4Z 4" - White
Tapered Hood with 12" Tailpipe



MLFVK48E
Semi-Rigid Duct
TD48PVKZW
Aluminum Foil Duct
Louvered vent kit, white, c/w hood, 4" x 8' duct and 2 clamps.



IH4WXZ 4" White
ProVent Intake hood. Fixed louvered, recessed caulk line, snap-on pipe



PMC4WX



PMH4WXZ

PMC4WX White/Blanc 4" cap only.
PMH4WXZ White/Blanc - Tailpipe
PROMAX Wide mouth vent hood for optimum airflow, backdraft damper, quiet, removable pest screen.



FDC4 4"
Dryer Duct connector or extension. Includes 2 plastic clamps.



CHK100ZW
Heat Keeper. Directs warm, moist air from the dryer back into the home.



TDIDVKZW
Indoor Vent Kit, 4" X 5' Ducting, with Pro Flex ducting



REVER&OMATIC

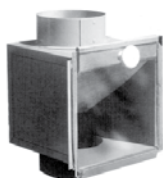

LT18044 4"
Lint trap kit with positive lock. Ceiling or wall mounted. Removable filter. Lint trap kit. Includes easy to remove door and lint trap. Surface mount.

021174
Replacement glass

REVER&OMATIC



6207 4"
Lint trap kit with positive lock. Ceiling or wall mounted. Removable filter.



Is your Dryer a Fire Hazard?

Fire departments recommend using a cleaning brush every 3 months to ensure proper air flow and to change ducting every 2-3 years!

Flexible 2 Ply Gray Vinyl Ducting

GFD425 4" X 25' Length

GFD625 6" X 25' Length

GFD825 8" X 25' Length

Uses:
Bath fans & Humidifier Venting



Dryer Booster



DVK100B-C w/current sensor

DVK100B-P w/pressure switch

Dryer booster fan. Thermal overload protection, inline construction, quiet external motor, auto reset. Enables longer runs and makes drying more efficient.

Dryer Booster Fan



OIF4P-KIT 4"

Fantech Dryer Booster Fan w/Pressure Switch. Use on duct runs up to 130 feet. Galvanized steel housing, automatic pressure sensing switch, mounting bracket, hardware and 5-1/2 ft. power cord with plug. Backward inclined impeller allows lint to pass through the fan. 120v, 60Hz, 1 phase, 173CFM Max

In-Line Booster Fan

Install in any single branch to increase hot or cold air flow supply. Manual or auto control. Wire to furnace, fan switch, sail switch, pressure switch, thermostat etc... 115V



Part #	Description	Max Boosted CFM
T9-DB204C	4" Round	80
T9-DB205C	5" Round	225
T9-DB206C	6" Round	250
T9-DB208C	8" Round	500
T9-DB212C	12" Round	800

Flexible insulated duct - Silver Socket

SPC325 3" x 25' Length

SPC425 4" x 25' Length

SPC525 5" x 25' Length

SPC625 6" x 25' Length

SPC825 8" x 25' Length

Flexible Insulated Ducting with 4.2 R insulation factor. Use in general ventilation applications including heating, air conditioning, intake and exhaust.



Dryer Booster Fan

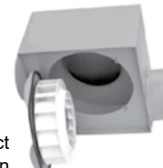

TLD200

- Self cleaning, non overloading wheel.
- Engineered for quiet continuous operation making it perfect for general purpose ventilation and dryer exhaust application.
- Low profile construction simplifies installation in those tight spaces.
- Built with a well balanced motor impeller assembly, and a backward inclined wheel for smooth quiet operation.
- 5" Dia inlet and outlet. 2 inlet, expandable to 3



Part# **CFM** **SIZE**

PVP-4L 100 4"

PVP - The Original Galvanized Inline Fans. Inline direct drive vent fan. Designed for simple install for years of maintenance free operation. Totally enclosed motor. Great in high moisture areas. Residential, commercial and industrial. 5 Year warranty

AXC Inline Duct Fans



Part#	CFM	RPM	DIMENSIONS			
			D	d	a	B
AXC100B-ES	152	2400	9.5	4	1.0	8.3
AXC125B-ES	212	2350	9.5	5	1.0	8.3
AXC150B-ES	309	2580	13.2	6	1.0	9.1
AXC200A-ES	418	2550	13.2	8	1.0	9.1
AXC200B-ES	636	2700	13.2	8	1.0	9.1

DESIGN FEATURES

Infinitely variable, up to maximum R.P.M., with the addition of a solidstate speed control. Capable of handling air up to 60°C/140°F, and are suitable for light dust and fumes. Simple to install. Designed to be maintenance free for most applications, for years of trouble-free service.

Spring Loaded Backdraft Dampers



Part#	SIZE
BDD100	4"
BDD125	5"
BDD150	6"
BDD200	8"

- 20 Gauge galvanized steel housing
- Aluminium spring loaded butterfly damper blades
- Damper seals against EDPM rubber gasket in closed position for minimal leakage
- Gasket designed for use in temp. from -22°F to 180°F
- Can be installed in any position

Panasonic

New!



FV-08WQ1

WhisperWall Through-the-Wall Fan

This fan features a totally enclosed condenser motor and a large, double suction blower wheel to quietly move air. Super quiet operation. ENERGY STAR® qualified. Easy installation. Through the wall ventilation fan, complete with an outside vent hood and back draft damper.



As GNN replacement parts are not available in the market you must order complete unit.



Complete fan units
Needs specifications visit
amresupply.com



Model	CFM	Sones
BPT12-02A	50	1.0
BPT12-14A1	70	0.8
BPT15-14A1	80	1.0
BPT15-24A1	110	1.5

GNN fans use an enclosed fan and motor assembly. If you recognize the assembly shown, chances are you have a GNN or alike fan.



Panasonic

The easiest retro-fit fan available.
Speed selector allows 80-110CFM
adjustments



FV-0811VF5	Standard Unit
FV-0811VFM5	W/Motion Sensor
FV-08-11VFL5	W/Light 2x13W

WhisperFit® EZ Fan.

Pick-A-Flow™ speed selector 80 or 110 CFM, Flex-Z Fast™ installation bracket and detachable installation adapter. Low profile 5-5/8" housing depth fits in 2x6 construction. Can be used to comply with the latest codes and standards.



Part#	CFM	Sones
ODS-8003-14	80	0.3
ODS-9003-14	90	0.3
ODS-1109	110	0.9

Universal Slimline Fans

Detachable 4-5" collar, back draft damper 11 3/8" x 10 1/2" x 6", with white poly grille. SmartSense Fan, can add speed control OD-SCK, humidity control OD-HSG, motion sensor grill OD-MSG or light grille, OD-LTG.



Panasonic



Part#	CFM	Sones	Duct
FV-0511VQ1	50/80/110	0.3	4"/6"
FV-08VQ5	80	0.3	4"
FV-11VQ5	110	0.3	4"
FV-15VQ5	150	0.3	6"
FV-20VQ3	190	1.3	6"
FV-30VQ3	290	2.0	6"

WhisperCeiling™ Ventilation Fan

Quiet operation. User friendly installation. Quality components for trouble free operation for years. Energy Star rated and LEED. Built-in damper. 4" or 6" duct.



Panasonic



All-Purpose, Customizable
IAQ Solution for Virtually
Any Application!

Part#	CFM	Sones	
FV-0511VKS1	30 to 110	0.3	No Light
FV-0511VK1	50-80-110	0.3	No Light
FV-1115VK1	110-130-150	0.3	No Light
FV-0511VKS1	30 to 110	0.3	With Light
FV-0511VKL1	50-80-110	0.3	With Light
FV-1115VKL1	110-130-150	0.3	With Light

WhisperGreen Select™ Customizable Ventilation Fan

Quiet operation. User friendly, Flex-Z-Fast installation bracket. Smartflow Optimum CFM Technology automatically adjusts to keep CFM steady. Variable speed control. Energy Star rated. Built-in damper. 4" or 6" duct.

Accessories:



FV-NLVK1
Niteglow LED Night Light with
Photocell



FV-VS15VK1
Multi-Speed with Time Delay



FV-MSVK1
SmartAction Motion Sensor



FV-CSVK1
Condensation Sensor



Panasonic

New adjustable speed and DC
Smartflow Features!



Part#	CFM	Sones
FV-0510VS1	50, 80 or 110	0.3 to 1.3

WhisperValue® DC™ Fan

The lowest profile ENERGY STAR® rated ventilation fan available at 3-3/8"H. Features Panasonic's revolutionary DC motor with SmartFlow™ optimum CFM technology, and incorporates a Pick-A-Flow™ speed selector switch to customize airflow (50, 80 or 100 CFM). 4" duct





Also available with light

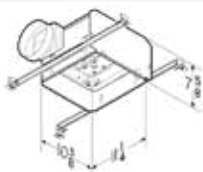

Part#	CFM	Sones
QTXE090C	90	0.6
QTXE110C	110	0.9
QTXE110H	110	0.9 w/humidity sensor

QTXE line represents the ultimate in bath fan solutions. Energy Star qualified & nearly silent operation. Housing features mounting ears, plus adj. hanger bars. Plug-in permanently lubricated motor - engineered for continuous operation. Anti-vibration motor mounts. 6" round duct connector. 3 Yr. warranty. Humidity sensor model has adj. sensitivity & run time



Also available with light



Part#	CFM	Sones
A80C	80	2.0
A110C	110	3.0
AE80	80	0.8
AE110C	110	1.0

TrueSeal™ Damper Technology, InVent fans reduce air leakage by up to 50%* compared to competitive models, resulting in better home performance via blower door tests and reducing cold and warm air backdrafts EzDuct™ Connector can be installed room-side with no attic access required, fan housing connection have never been easier. 4" duct.



Part#	CFM
Multi-Speed	
ZB90C	90
ZB90HC	90 w/humidity sensor
ZB110C	110
ZB110HC	110 w/humidity sensor

Broan Ultra Green Bathroom Exhaust Fan. 60% faster retrofit installation. Installs completely from under the ceiling. 0.3 sones for nearly silent operation. Multi-speed models auto adjust speed to maintain required CFM. 4" or 6" duct.

Fastest, Easiest, Most Universal Installation!



New!

504

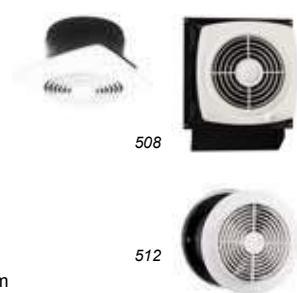

Part #	CFM	Sones	Discharge
504	350	6.5	Vertical
505	180	6.5	Vertical
508	270	6.0	Through Wall
509	180	6.5	Through Wall
512	90	3.5	Room-to-Room

Broan Utility Fans

Eliminate humidity from laundry rooms, tobacco smoke from recreation rooms and workshops or cooking fumes from kitchens with Broan's high-efficiency utility ventilators. All feature powerful, permanently lubricated motors in rugged steel housings. Attractive low profile white polymeric grilles can be painted to match the surrounding wall colour.

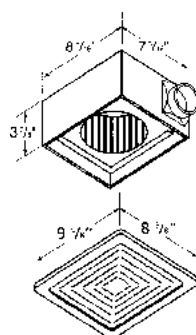

Part#	CFM	Sones
EC50	50	3.0
EC70	70	4.5

Torsion spring grille mounting fan, compact housing fits easily between wall studs. Double strength steel mounting flanges with keyhole slots for fast installation. Ceiling/wall application, 3" duct connector. Available in single or builder packs



Part#	CFM	Sones
SA-50D	55	0.3
SA-70D	80	0.3
SA-90S	110	1.0

Reversomatic Ventilation Fans

Quiet operation with low energy consumption. Designed for continuous operation. Install over tub or shower on GFCI circuit. External electrical junction box for easy installation. Energy Star rated. 4" duct.



AMRE is a full line distributor for Continental Fans



Part#	CFM	Sones
TBF90	50-80	0.9-2.0
TBF120	80-110	1.0-2.0

Continental Aerofan Bathroom Fan. 2 speed operation, long life ball bearing condenser motor, thermal overload protection, built-in damper, adjustable mounting brackets, easy install. Fits 4" and 5" ducts.



Part#	CFM	Sones	Duct
CF50	50	3.5	3"
CF70	70	3.5	4"

Continental Bathroom Exhaust Fan, Economy Series. Easy installation, built-in damper, 24" adj mounting brackets, efficient AC motor, 120v



Part#	CFM	Sones
TF80	80	0.4
TF80L	80	0.4 w/light
TF110	110	0.9
TF110L	110	0.9 w/light

Continental Bathroom Exhaust Fan, Tranquil Series. Superior ventilation and efficiency, whisper quiet, easy installation, 24" adj mounting brackets, built-in damper, 4" or 6" duct, 120v, lighted models GU24 max 26W





F650 50CFM

F675 75CFM
Broan bath fan motor & grill assembly. Fits housing #H600 8" X 8"



ECF70 70CFM
8" X 7-1/8", No housing, cover included

Great Upgrade Option



Upgrade Kit!
EC60KIT
Broan bath fan upgrade kit. 60CFM
- Reduce sound up to 45%, 0.3sones
- Simple install
- Cover included
- Replaces Broan and Nutone models 685, 696, 690, EC50/70, ECF50/70, ECH600



S97009745 (F684N, 684, 676)
Bath Fan Motor Assembly, Fits Broan 684N and 676



S97006222
Stack: 7/8"
RPM: 2000
Amps: 1.72
Rotation: CW
Speed: 1
Shaft: 1/4" x 2-5/8"
Volts: 120
Mounting: Bracket
With 2 Prong Plug
Broan motor and blower assm. (161/162)



S97017705
Bath Fan Motor Assembly, Fits Broan 750



S97015159
Bath Fan Motor Assembly. Fits Broan DX90, 671



BLADE - 99020014
82583 (30080058)
Diameter 3.3"
HP: 1/100
Stack: 2-1/2"
RPM: 1550
Amps: 0.55
Rotation: CCW
Speed: 1
Shaft: 5/16" x 1-3/4"
Volts: 120
Bearing: Sleeve
Mounting: Hub Mount
With Wire Harness Plug



BLADE - 30020079
R3-R322 (30080111)
Diameter 3.3"
HP: 1/60
RPM: 1550
Rotation: CW
Speed: 1
Shaft: 1/4" x 1.3"
Volts: 115
With cord & plug
Exhaust Fan Replacement Motor
Fits Broan 676, 684N, 712, 721 & 722 Fans. Replaces Broan # 30080111 & 30080112



S99080180
Frame Type: C Frame
Speed: 1
Volts: 120
Mounting: Back Studs
With 2 Prong Plug
Use with 509



S97016778
Frame Type: C Frame
Stack: 1-3/8"
Amps: 1.5
Speed: 1
Shaft: .2178" x 1-1/4"
Volts: 120
Mounting: Back Studs
With 2 Prong Plug
Use with Broan 503A, 503B, 505A & 505B



T1-R601
Frame Type: C Frame
HP: 1/80
RPM: 3000
Rotation: CW
Speed: 1
Shaft: 1/4" x 2.2"
Volts: 115
With cord & plug
Replaces some Broan Fam Motors
Fits Broan 161 & 162 Series Fans
Replaces Broan # 30080007



S99080448
Broan Bath Fan Motor. Fits Broan S80U



BLADE 99020014 - CCW
99020015 - CW
S99080151
(30080059/60)
Use with 362 Broan Fans
Double Shaft
With Wire Harness Plug



O6-R260
Diameter 3.3"
HP: 1/90
RPM: 1550
Rotation: CCW
Speed: 1
Shaft: 2/16" x 1.10"
Volts: 115
With cord & plug
Also Replaces Reversomatic # 013012.
Works with B60 Reversomatic Fans



T1-R604
Frame Type: C Frame
HP: 1/85
RPM: 2700
Rotation: CW
Speed: 1
Shaft: 0.181" x 1.2"
Volts: 115
With cord & plug
Exhaust Fan Replacement Motor
Also replaces some Nutone Exhaust Fan motors & Chromalox heater motors



696NCB (ECF50)
50 CFM, 7" X 8", no housing. Includes Motor Grill Fan Blade & Bracket. Use for 696 Nutone Fans



65894K
Frame Type: C Frame
RPM: 3000
Speed: 1
Rotation: CCW
Shaft: 7/32" x 2-3/8"
Volts: 120
Replaces Nutone K5895 Motor & Motor Kit K5894. Models 65894K, 9415FC & 9415WHC Exhaust Fans. Includes: Motor, Fan Blade, Mounting Bracket & Plug.



40696 (JA2C394N)
RPM: 1400
Speed: 1
Amps: .8
Rotation: CCW
Volts: 120v
With 2 Prong Plug
Use with QT110, QT100L & QT100FL
Will also work on QT80 & QT90 Upgrading them to 110CFM. Includes: Motor, Blower Wheel & Mounting Plate.



T1-R3100
Exhaust Fan Motor
Diameter or Frame Type: C Frame
HP: 1/130
RPM: 3000
Rotation: CW Opposite Shaft End.
Speed: 1
Shaft: 7/32" x 1.7"
Volts: 115
With cord, plug & Fan Blade



O6-R209
 Diameter 3.3"
 HP: 1/4"
 RPM: 1550
 Rotation: CW
 Speed: 1
 Shaft: 1/4" x 1.5"
 Volts: 115
 With cord & plug
 Replaces Emerson/Broan/Nutone/Miami
 Carey



24 HR.



**Order by
 4pm for
 24-48hr shipping
 to almost anywhere in
 Canada!**

O6-R203
 Diameter 3.3"
 HP: 1/70
 RPM: 1550
 Rotation CCW
 Speed 1
 Shaft: 1/4 Threaded
 Volts: 115
 With cord & plug



NuTone

R3-R355 (81918, 22
 Diameter 3.3"
 HP: 1/15
 Volts/Hz: 115v
 Amps:2.20
 RPM: 1550
 Speed: 1
 Rotation: CW
 Shaft: 5/16" Dia. x 1.9 "L
 Body Length/Stack: 3.11"
 Motor Type: Shaded Pole
 Bearing: Sleeve
 Enclosure: Open
 Mounting: Hex Hub
 Wiring: Leads

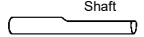

NuTone
O6-R222
 Diameter 3.3"
 HP: 1/75
 Volts/Hz: 115v
 Amps:0.72
 RPM: 1600
 Speed: 1
 Rotation: CCW
 Shaft: 1/4" Dia. x 2.3 "L
 Body Length/Stack: 2.09"
 Motor Type: Shaded Pole
 Bearing: Sleeve
 Enclosure: Totally Enclosed
 Mounting: Stud
 Wiring: 2 Prong Plug
 NuTone/Leigh/Can-arm

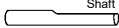
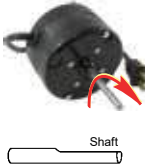

NuTone
R3-R315
 Diameter 3.3" Dia.
 HP: 1/90
 Volts/Hz: 115v
 Amps:0.53
 RPM: 1550
 Speed: 1
 Rotation: CCW
 Shaft: 1/4" Dia. x 1.3 "L
 Body Length/Stack: 2.09"
 Motor Type: Shaded Pole
 Bearing: Sleeve
 Enclosure: Open
 Mounting: Hex Hub
 Wiring: 2 Prong Plug
 NuTone/Leigh/Can-arm

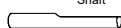

NuTone
R3-R311
 Diameter 3.3"
 HP: 1/100
 RPM: 1550
 Voltage:115
 AMPS: 0.47
 Speed: 1
 Rotation: CW
 Motor Type: Shaded Pole
 Enclosure: Open
 Body: 2.09"
 Frame: 3.3" Dia
 Shaft: 1.2" x 1/4"
 Bearing: Sleeve
 Mounting:Hex Hub
 Wiring: 2 Prong Plug/Leads

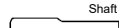

NuTone
O6-R506 (80725)
 Diameter 3.3"
 HP: 1/240
 Volts/Hz: 115v
 Amps:0.43
 RPM: 1400
 Speed: 1
 Rotation: CW
 Shaft: 1/4" Dia. x 2.0 "L
 Body Length/Stack: 1.90"
 Bearing: Sleeve
 Enclosure: Totally Enclosed
 Mounting: Stud
 Wiring: 2 Prong Plug

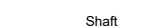

NuTone
R7-RB11
 Exhaust Fan Motor
 Diameter or Frame Type: C Frame
 HP: 1/130
 RPM: 3000
 Rotation: CW
 Speed: 1
 Shaft: 7/32" x 1.7"
 Volts: 115
 With cord, plug, bracket & Fan Blade



NuTone
O6-R201
 Diameter: 2.3"
 HP: 1/50
 Volts/Hz: 115v
 Amps: 0.85
 RPM: 1550
 Speed: 1
 Rotation: CW opposite shaft end
 Shaft: 1/4" Dia. x 2.3 "L
 Body Length/Stack: 2.25"
 Motor Type: Shaded Pole
 Bearing: Sleeve
 Enclosure: Totally Enclosed
 Mounting: Stud
 Wiring: Leads
 Electrohome NuTone

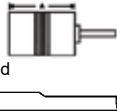

NuTone
R3-R305 (80695)
 Diameter 3.3"
 HP: 1/60
 RPM: 2800
 Rotation: CW
 Speed: 1
 Shaft: 1/4" x 1.5"
 Volts: 115
 With cord & plug

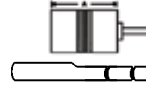

**IMPORTANT
 NOTICE**



Due to some corporate restructuring, many AirKing Parts are no longer available and many are only while quantities last. Our team is working hard on finding suitable replacements during this transition. If you have any questions, please don't hesitate to contact us.

AirKing
T1-R603
 Air King Motor Fan Part
 Frame Type: C
 HP: 1/125
 RPM: 3000
 Rotation: CW
 Speed: 1
 Shaft: 7/32" x 2.7"
 Volts: 115
 With cord & plug



NuTone
T1-R610
 Frame Type: Skeleton
 HP: 1/60
 Volts/Hz: 120v
 Amps:0.75-1.0
 RPM: 2400
 Speed: 2
 Rotation: CW
 Shaft: 7/32" Dia. x 1.2 "L
 Body Length/Stack: 0.90"
 Motor Type: Shaded Pole
 Bearing: Sleeve
 Enclosure: Open
 Mounting: Studs



NuTone
T1-R613
 AirKing Fan Part
 Frame Type: C
 HP: 1/100
 Volts/Hz: 115v
 Amps:0.55
 RPM: 1600
 Speed: 1
 Rotation: CW
 Shaft: 7/32" Dia. x 2.5 "L
 Body Length/Stack: 0.65"
 Motor Type: Shaded Pole
 Bearing: Sleeve
 Enclosure: Open
 Mounting: Stud
 Wiring: 2 Prong Plug



Universal



T1-R670 115V
T1-R3670 115/230V
 Universal C Frame Motor Kit with 2 blades, hdw and 2 prong plug. Fits all "C" Frame and 3 1/2" Round Style motors. Applications: Refrigeration, Exhaust Fans, Ventilator Fans, Range Hoods, Electric Unit Heaters, Forced Air Heaters etc..
 T1-R670: 1/125HP, 115V, 0.5A, .65" stack, 3000RPM, CCW, 3/16" x 1.3" shaft
 R3670: 1/150HP, 115/230V, 0.45/0.25A, .65" stack, 3000RPM, CCW, 3/16" x 1.475" shaft

NOTE:
 mounts from rear

T1-R3550
 Frame Type: C
 HP: 1/115
 Volts/Hz: 115v
 Amps:0.60
 RPM: 3000
 Speed: 1
 Rotation: CW
 Shaft: 7/32" Dia. x 1.7 "L
 Body Length/Stack: 0.55"
 Motor Type: Shaded Pole
 Bearing: Sleeve
 Enclosure: Open
 Mounting: Rear Studs
 Wiring: 2 Prong Plug



NOTE:
 mounts from front

T1-R3549
 Frame Type: C
 HP: 1/115
 Volts/Hz: 115v
 Amps:0.60
 RPM: 3000
 Speed: 1
 Rotation: CW
 Shaft: 7/32" Dia. x 1.7 "L
 Body Length/Stack: 0.55"
 Motor Type: Shaded Pole
 Bearing: Sleeve
 Enclosure: Open
 Mounting: Front Studs
 Wiring: 2 Prong Plug





O6-R206
Miami Carey/
Air King/BD/Waite
Diameter 3.3"
HP: 1/80
RPM: 1550
Rotation: CW
Speed: 2
Shaft: 1/4" x 1.5"
Volts: 115
With wire harness plug



013070
RI150, 200 + 250, RH4000, TLD200

013071
TL-240
General Purpose Rangehood and
Dryer Exhaust Fans. Self cleaning,
quiet continuous operation, includes
motor, bracket and wheel.



4166 **4191**

4191 QCF-110 / 1200 RPM / 0.3 Amps / 27W / 100CFM
4166 QCF-125 / 1050 RPM / 0.6 Amps / 1/90 HP
High performance and quiet operation. Includes motor, bracket and wheel



4143 Reversomatic
R7-RB30 Alltemp
Blower Motor Kit, includes motor, bracket
and wheel. Reversomatic DK260.
(R2603 Motor Only)



4105 (B-100)
4107 (QB100S)
4109 (#QK-100, K-100)
BK100MBB (#BK-100)
4099 (#B-60)
QB80MBG (QB80)
Reversomatic XL series replacement blower
kits. Includes motor, bracket and fan blade.



013041
Reversomatic motor.
Use with DK260, PW200, PWS200 &
PWS-200PS Reversomatic Fans
CFM: 268
RPM: 1550
Amps: 1.15
Wiring: 2 Prong Plug
HP: 1/35



O1-R408
Rotom Motor
Diameter 3.3"
HP: 1/60
Volts/Hz: 115v
Amps: 0.72
RPM: 1550
Speed: 2
Rotation: CCW
Shaft: 1/4" Dia. x 1.6 "L & 1/4" Dia. x
1.6 "L
Body Length/Stack: 2.25"
Motor Type: Shaded Pole
Bearing: Sleeve
Enclosure: Open
Mounting: Stud
Wiring: Leads



R7-RB25
Rotom Reversomatic replacement motor. Replaces 4109 to fit K100 XL series
fan units.



O6-R266
Reversomatic
motor. (BK100)
Diameter 3.3"
HP: 1/20
RPM: 1550
Rotation: CCW
Speed: 1
Shaft: 5/16" 1.4"
Volts: 115
Mounting: Back Studs
With cord & plug



R7-RB20
Reversomatic motor kit. Incl bracket &
wheel (EB45/EB50)
Frame Type: Skeliton
HP: 1/85
Volts/Hz: 115v
Amps: 0.76
RPM: 1550
Speed: 1
Rotation: CW
Shaft: 7/32" Dia. x 1.9 "L
Body Length/Stack: 3.25"
Motor Type: Shaded Pole
Bearing: Sleeve
Enclosure: Open
Mounting: Bracket
Wiring: 2 Prong Plug



013011
Reversomatic B-100
motor Replacement
Option for 013011
Reversomatic Motor
(can be replaced with 4105 Motor,
Fan Blade & Bracket Assembly)
RPM: 1400
HP: 1/15
Rotation: CCW
CFM: 100
Volts: 115
Shaft: 5/16" x 1-1/2"
Wiring: 2 Prong Plug



013042
Reversomatic motor.
Use with CF375, CF425, DB300,
DBP300, GBP400, PWS300 & SMP300
Reversomatic Fans
CFM: 300
RPM: 1550
Amps: 1.20
Wiring: 2 Prong Plug



O6-R207
Diameter 3.3"
HP: 1/70
Volts/Hz: 115v
Amps: 0.80
RPM: 1550
Speed: 1
Rotation: CW
Shaft: 1/4" Dia. x 1-5 "L
Body Length/Stack: 2.10"
Motor Type: Shaded Pole
Bearing: Sleeve
Enclosure: Totally Enclosed
Mounting: Stud
Wiring: 2 Prong Plug
Miami-Carey/Air King



M3-R2603
Reversomatic
motor (DB200)
Diameter 4.1"
HP: 1/23
RPM: 1550
Rotation: CW
Speed: 1
Shaft: 1/2" x 2.2"
Volts: 115
With cord & plug



014028
Reversomatic Exhaust Fan Capacitor. 8MF. Use with TL240, TL240ES,
TLD200, TLD200ES, TLD200ES,
TLD200L, TLD200PS, TLD300 &
TLD300L Reversomatic Exhaust Fans.



XR190-2B15-11
Universal fan and motor assembly, fits
Reversomatic and Aeroflo

Insert Heater Motors



T1-R611
Chromalox heater motor.
Frame Type: C
HP: 1/300
RPM: 1500
Rotation: CW
Speed: 1
Shaft: 0.181" x 1.7"
Volts: 115
With cord & plug



T1-R684
Mr. Whisper/Nuvent
HP: 1/70
Volts/Hz: 115v
Amps: 0.80
RPM: 3000
Speed: 1
Rotation: CCW
Shaft: 7/32" Dia. x 2.10 "L
Body Length/Stack: 0.875"
Motor Type: Shaded Pole
Bearing: Sleeve
Mounting: Stud
Wiring: 2 Prong Plug



O6-R210
Diameter 3.3"
HP: 1/50
RPM: 1500
Rotation: CCW
Shaft: 1.5" x 1/4"
Volts: 230
bare wire leads



O6-R213
Trane, Lincoln,
Chromalox insert heater motor.
Diameter 3.3"
HP: 1/25
RPM: 1550
Rotation: CCW
Speed: 1
Shaft: 5/16" x 1.7"
Volts: 115



T1-R617
Dimplex, Westcan,
Chromalox insert
heater motor.
HP: 1/285
RPM: 1900
Rotation: CCW
Shaft: 1" x .181"
Volts: 208/230
bare wire leads



Don't see the part you are looking for? Visit amresupply.com for 100's of in-stock fan parts!

AirKing



5S1201008
AirKing Fan Part Grill assembly for models BFQ/AS50/BF50/60/75, 10" x 9-1/2"

REVERSOMATIC



014190 10 X 10 (EB)
014191 12 X 12 (EB)
Reversomatic Fan cover, high impact plastic, white

BROAN



10880266
Broan 9-1/2" X 9-1/2", Grill comes with springs. Fits F650/F675

BROAN



S97013576
Broan Grill assembly deluxe, for models 676/684/DX90/DX110, 11-1/4" x 10-3/4"

NuTone



S97017607
Nutone 10-1/4" X 10-1/2"
Grill comes with springs

NuTone



S13178018
Nutone 8-5/8" X 10-1/2", Aluminium grill

REVERSOMATIC



No Springs
K100F Hole mount 11-1/8" x 11-1/8"
Spring loaded (QB80/QB100S/K100/QK100/BB100/BK100.)
Painted aluminium white, fits Reversomatic XL Fan Series, with clips

011104 No Hole 11-1/8" X 11-1/8"
4064 No Hole 10" X 10-1/2"
011184 No Hole 13" X 13"

BROAN



30110246
Broan/Nutone bath fan grill w/clips EC50/EC70/693C/696NC/695C/VS-BP50M, 9-5/8" X 8-5/8"

BROAN



S97009281
Broan bath fan grill w/clips S50U/S800/S110U/S90H/SL30H, 11-1/2" x 11-1/2"

NuTone



13173000
Nutone bath fan chrome grill, threaded nut

NuTone



20310000
Nutone bath fan blower wheel 1/4" shaft, 1-1/4"H X 5-1/4"Dia.

BROAN



S99020144
Broan blower wheel, model 161

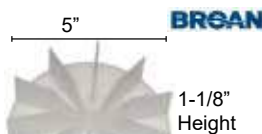

99110446
Broan blade models 675/741BR/741WH/741SN 5"D X 1-1/8"H

BROAN



30020086
Broan blade 4-1/2" Wide x 1-1/8" High models 650/660/678N, 678N-FL

NuTone



93-A7100
NuTone blade 4-1/2" Wide x 1-1/8" High models 663LCN/667NC

BROAN



99020166
Broan blade model 502/4/8/10 incl B

BROAN



S99020165
Broan blade model 503/5/9/11 incl B

NuTone



A65900
NuTone blower wheel model 671R/672R/QT80/90/QT110 2" x 6" Dia.

BROAN



S97009755 (99110842)
Broan blade plastic models 676/684N/712, 721/722 5-3/8"D X 2-1/2"H



Wall Mount Baseboard



Model K

Electric Baseboard Heaters. Quiet running, back wire design, built-in cable clamps, crushproof element, baked enamel finish, soft contoured covers, bright white, 6-3/4"H x 3-1/8"D

120V Part #	Watt	Size
2K1205BW	500	27"
3K1207BW	750	36"
4K1210BW	1000	48"
5K1212BW	1250	60"
6K1215BW	1500	72"

240V Part#	Watt	Size
2K2405BW	500	27"
3K2407BW	750	36"
4K2410BW	1000	48"
5K2412BW	1250	60"
6K2415BW	1500	72"
8K2420BW	2000	96"



KP1210 48"
King Electric portable baseboard heater.
- 1000W, 120V, 8.3A
- Built-in thermostat
- Safety features
- 6ft cord and plug
- 3-1/8"W x 7-1/4"H x 48"L



Thermostats Poles
BKT1BW Single
BKT1BW-TP Single (Tamper proof)
BKT2BW Double
BKT2BW-TP Double (Tamper proof)
 Electric Baseboard Thermostat. 120V/208/240V/277, Bright White. No positive on or off, 45F to 80F range, 22Amp. *Note: By removing faceplate these thermostats will fit some other brands of baseboard heaters*



ATMOS1-B 1 Pole 120-240V
ATMOS2-2 2 Pole 240V
 King Electric Atmos Bluetooth Programmable Thermostat. For baseboard, fan forced and radiant electric heaters, 30-60ft bluetooth range, saves up to 28%, 5-32°C



ATMOZ1-240-WIFI 1 Pole 240V
ATMOZ2-240-WIFI 2 Pole 240V
 King Electric Atmoz WiFi Programmable Thermostat. For baseboard, fan forced and radiant electric heaters, saves up to 28%, 5-32°C, Atmoz smart App, full Wifi use.



TKIT-1 1 Pole
TKIT-2BW 2 Pole
 King Electric wall heater and baseboard thermostat.
 - 45°F to 80°F (7°C - 27°C)
 - 120/208/240V
 - 25 Amps Max
 - Use with King PAW, PZ, W and baseboard series



Unique Pic-a-watt element allows 7 wattage configurations



PAW1215-W 120V, 250-1500W
PAW2422-W 240V, 500-2250W
 King Electric Wall Heater. Whisper Quiet 65CFM Fan, C-frame motor w/ squirrel cage blower. Bright white, 20ga powder coated. See TKIT-1,2 for thermostat options. 13-1/2"W x 7-1/2"H (grill size)



Unique Pic-a-watt element allows 7 wattage configurations

SL1215-W 120V, 250-1500W
SL2422-W 240W, 500-2250W
 King Electric Surface Mount Wall Heater.
 - Whisper Quiet 65CFM Fan, C-frame motor w/squirrel cage blower
 - Multiple watts Pic-a-watt element w/7 config.
 - Bright white, 20ga powder coated
 - See SLT-1, 2 for thermostat options
 - 13-5/8"W x 10-3/8"H x 4"D



Condenser Fan Motors

- D917 1/6 HP
- CF-3732 1/4 HP
- CF-3733 1/3 HP
- CF-3734 1/2 HP
- CF-3735 3/4 HP

Condenser Fan Motors, 5.5" single shaft, 208/230V totally enclosed ball bearing

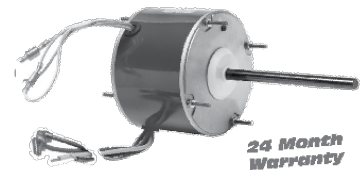

5.0" MultiFit Condenser Fan Motors

- Included
- Durable collar studs with 5/8" extension, 8-32 threads motor.
 - Extra mounting nuts with locking feature
 - Easy-to-install plugs

Volts: 208/230 - Rot. REV - Shaft 1/2" x 3"

Part #	HP	Amps	RPM	Type	Body
M4-R2722	1/8, 1/10, 1/12	0.9	1/1075	5/370	4.0"
M4-R2723	1/4, 1/5, 1/6	2.0	1/1075	7.5/370	4.5"



Part# HP Shaft
UE-381 1/10HP 1/2" x 10.63"
 5.0" Fan coil/Air conditioning motor. 42 frame, 1075RPM, 208/230V, 3 speed, CW, open enclosure.



Part# CFM A Dim
RFC300 300 6.75"
66-RFC400 400 8.25"
66-RFC600 600 9.0"
 Heating/AC Fan Coil Blower. Motor not included.

Part# HP Shaft
M4-R2693 1/10HP 3/8" x 8"
 5.0" Fan coil/Air conditioning motor. 1050RPM, 42 frame, 115V, 5 speed, CCW, open enclosure.



Furnace, Unit Heater, Fan Coil Unit, or any other HVAC
Over 1000 Motor's in Stock!

Just give us a call with your motor information and we can get you back up and running!

HVAC





UE-89

- Fan Coil/Air conditioning/PTAC Motor
- 1/10, 1/20, 1/30, 1/40 & 1/70HP
 - 5.0", 42Y frame
 - Continuous Open Air Over
 - Sleeve Bearing
 - 1/2" x 10-3/16" shafts
 - Automatic Protection
 - 115V, 1050RPM, 60/50HZ, 5 Speed

Brushless Energy Saver



Save Up To 69%

CS89 1/10HP

- Fan Coil/Air conditioning/PTAC Brushless DC Energy Saving Motor
- 5.0", 42Y frame
 - PSC, Continuous Open Air Over
 - Ball Bearing, reduced motor vibration
 - 1/2" x 9.3" shafts
 - Automatic Protection
 - 120V, 700/900/1100RPM, 60Hz, 3Spd

Upgrade to energy saver

UE-799 1/8HP Century

DD-029 1/8HP Rotom

DD-030 1/6HP Rotom

- Fan Coil Motor.
- 5.0", 42 frame, 1/2" x 4.3" shaft
 - Reversible, Open enclosure
 - 115V, 1000RPM, 5 Speed
 - Multi-Fit, 1/8, 1/10, 1/2HP, UE-799 also 1/15, 1/20 & 1/30HP
 - Direct replacement for Climatec, Snyder-General, Temspec, Unilux



Furnace Motors

Belted Furnace

840CV 1/4HP

841CV 1/3HP

1542C 1/2HP

- Belt Drive Fan Blower Motor
- 5-5/8", 48/56 frame
 - Open drip proof, resilient base
 - Split Phase, Sleeve Bearing
 - Reversible, automatic protection
 - 1/2" x 1-7/8" shaft
 - Includes 5/8" shaft adapter & key
 - 115V, 1725RPM, 1 Speed



DD-034 1/4HP 115V

DD-044 1/4HP 208/230V

DD-035 1/3HP 115V

DD-045 1/3HP 208/230V

DD-036 1/2HP 115V

DD-046 1/2HP 208/230V

Tri-Flex Mount Universal Blower Motor.

- 5-5" Dia, 48Y frame
- Sleeve bearing, (035 & 036 Ball Bearing)
- Reversible, permanent split capacitor
- 1/2" x 6" shaft, 9" & 10" bolt circle
- Automatic overload
- 115V, 1075RPM, 60HZ, 4 Speed



Direct Drive

Replaces 1/3, 1/4, 1/6, 1/7 HP motors



Multi-Fit 1/2, 1/3, 1/4, 1/5 & 1/6HP

(Sleeve Bearing)

5460 115V

5461 208/230V

Multi-Fit 3/4, 1/2, 1/3, 1/4, 1/5HP

(Ball Bearing)

5470 115V

R6-R43603 208/230V

Direct Drive Blower Motor. Multi-Fit

- 5.5" Dia, 48 frame
- PSC, Reversible
- Continuous Duty/Over air
- Automatic protection, 1 Phase
- 1/2" x 5" shaft (5.5" on R3-R43603)
- 1075RPM, 60HZ



RESCUE - High Efficiency ECM/BPM Drop-in Blower Motor!



5522ET 1/6-1/3HP

5532ET 1/4-1/2HP

5542ET 1/3-3/4HP

- Electronically Controlled
- Brushless Permanent Magnet Motor
- Reversible, Ball bearing
- 48 Frame (5.6" diameter)
- No Capacitor Required
- Continuous Duty, Air Over
- 1/2" x 4.5" shaft, 1075 RPM's
- 115/208-230v, 5 speed ranges

Multi HP Replacement

- DD-1314** 1/3 HP, 115V, 6.0Amps. Cap. 7.5/370, SPD/RPM: 4/1075. Dim: 4.40"
- Features 48 Frame, 5.5" Dia. open enclosure. Mounting stud, strap & Base (Resilient rings), 60HZ, sleeve bearing, reversible. Permanent split capacitor. 60" coloured electrical leads. Insulation Class B and thermally protected



R6-R42310 1/3HP

- Direct Drive Blower Motor
- Common Lennox replacement (100,000btu)
 - 5.5" Dia, 42Y frame
 - PSC, sleeve bearing, open enclosed
 - 1/2" x 5.2" shaft
 - 115V, 1075RPM, 4 Speed

UE-559 1/5HP

- Direct Drive Blower Motor
- Common Lennox replacement (80,000btu)
 - 5" Dia, 42Y frame
 - Open Air Over, sleeve bearing
 - 1/2" x 3-5/8" shaft
 - Automatic overload, 1 Phase
 - 115V, 1050RPM, 60HZ, 4 Speed



Ball Bearing



UH-9034 1/6HP

UH-9035 1/4HP

UH-9036 1/3HP

- Universal PSC Unit Heater Motor.
- 5.5" Dia, 48 frame
 - Totally enclosed ball bearing
 - 1/2" x 3.4" shaft
 - Reversible, permanent split capacitor
 - 115V, 1075RPM, 60HZ, 1 Speed

Draft inducer blower motors



FB-RFB43 1/60HP

- Draft Inducer Blower/Flue Exhaust Motor
- 5.8" Body, 3.3" frame
 - Split Phase, Sleeve Bearing
 - Open enclosure
 - CW rotation
 - 115V, 3000RPM, 0.80A, 1 Speed
 - Replaces Lennox G24 Mid Efficiency Residential: 43K41

FB-RFB547 1/20HP

- Draft Inducer Blower/Flue Exhaust Motor
- 5.8" Body, 3.3" frame
 - Split Phase, Ball Bearing
 - Open enclosure
 - CW rotation
 - 115V, 3400RPM, 1.80A, 1 Speed
 - Replaces Lennox G26 High Efficiency Series Residential: 68K21, Fasco 7021-9450



SPP5

SUPER BOOST 270 OZ. INCHES
For all PSC. Single phase air-conditioning & heat pumps - 120V. Can be used on 120 Thru 288 VAC units



SPP6

SUPER BOOST 390 OZ. INCHES
For all PSC. Single phase air-conditioning & heat pumps, 120-130V. Can be used on 120 Thru 288 VAC units

RO41 1/4-1/3hp

RO81 1/8-1/6-1/5hp

Relay and Overload Combinations. Snap on bracket, winding overheating protection, can use with and without start capacitor motors, always expanding, 115V. Snap on bracket.



One Pole Contactors

- One pole contactor with shunt
- UL cUL CE Approved
- 4 - 1/4" Brass Spade Terminals Per Power Conn.
- #10-32 Combination Screw Terminals
- 50/ 60 Hz SIZE: 2.39"H x 2"W x 3.29"D



HC-13024

Part #	Full Load Amps	Coil Volts 50/60	Resist. Amps	Locked Rotor Amps @240V
DP-1P30A24	30	24	40	150
DP-1P30A120	30	120	40	150
DP-1P30A240	30	208/240	40	150

Two Pole Contactors

- UL cUL CE Approved
- 30 Amp.= 4 - 1/4" Brass Spade Term. Per Power Conn.
- 4 - 1/4" Copper Spade Terminals Per Power Conn.
- 50/ 60 Hz
- Dust/Arc Cover Over Contacts (40 Amp Models & Up)
- SIZE: 2.5"H x 2"W x 3.29"D (approx.)



HC-23024

Part #	Full Load Amps	Coil Volts 50/60	Resist. Amps	Locked Rotor Amps @240V
DP-2P30A24	30	24	40	150
DP-2P30A120	30	120	40	150
DP-2P30A240	30	208/240	40	150
DP-2P40A24	40	24	50	200
DP-2P40A120	40	120	50	200
DP-2P40A240	40	208/240	50	200

HC-33024

Three Pole Contactors

- UL cUL CE Approved
- 30 Amp.= 4 - 1/4" Brass Spade Term. Per Power Conn.
- 40 Amp.= 4 - 1/4" Copper Spade Term. Per Power Conn.
- 50/ 60 Hz
- Dust/Arc Cover Over Contacts With Built-In Test Button
- SIZE: 3"H x 2.5"W x 4"D (approx.)



Part #	Full Load Amps	Coil Volts 50/60	Resistance Amps	Locked Rotor Amps @240V
DP-3P30A24	30	24	40	180
DP-3P30A120	30	120	40	180
DP-3P30A240	30	208/240	40	180
DP-3P40A24	40	24	50	240
DP-3P40A120	40	120	50	240
DP-3P40A240	40	208/240	50	240
DP-3P60A240	60	208/240	75	360

PART#	MFD/370V	BASE
36-5J370	5	J
36-7.5J370	7.5	J
36-10-370440	10	J
36-15K370	15	K
36-255R3744*	25/5	R
36-305R3744*	30/5	R
36-355R3744*	35/5	R

* Dual voltage 370/440V



J

K

R



Run Capacitors Single Note: Higher Voltages May be Substituted for Lower Voltages in the Same MFD. Rating.

SIZES MEASUREMENTS

J	1.31" X 2.06"
K	1.90" X 2.80"
R	1.97" X 3.54" - 4.33" (see website)



Relays

General Purpose Fan Relays - Standard Duty

Designed for switching single or two speed fan motor, relays, solenoids, resistive loads in cooling, heating or general purpose switching applications.

- Replace WR/ Essex/ RBM & Mars type 84 models
- Totally enclosed compact design.
- Quiet & reliable operations.
- UL & cUR (file E44211)
- SPST & SPDT models.
- Universal mounting bracket.
- Nominal VA Sealed: 3.5 & 4 inrush VA



Coil Voltage	Part # SPST	Part # SPDT	Coil Resistance DC OHMS ±10%	Nominal Current MA
24	25-90290	25-90293	90	146
120	25-90291	25-90294	2,000	29
240	25-90292	25-90295	7,200	15

Totally Enclosed Fan Relays - Heavy Duty

• Temperature Range: -20°C (-4°F) to 40°C (104°F).
• Terminals: 1/2" quick-connects.
Designed for cooling, heating or general purpose switching equipment operating heavier loads.

- Replace WR/ Essex/ RBM & Mars type 184 models
- Totally enclosed compact design.
- Quiet & reliable operations.
- Universal mounting bracket



25-90380

Coil Voltage	Part # SPDT	Part # SPNO-SPNC	Coil Resistance DC OHMS ±10%	Nominal Current MA	Nominal VA Sealed	Inrush VA
24	25-90370	25-90380	77	167	4	4
120	25-90372		2,000	33	4	4
240	25-90374		7,200	17	4	4

Totally Enclosed Relay - 2 Pole HVAC Switching Relays

• Temperature Range: -40°C (-40°F) to 54°C (130°F).
Intended for many applications in air conditioning, refrigeration, heating and general purpose switching.

- Replaces Honeywell, White-Rodgers/RBM & Mars (cross reference in packaging)
 - Semi-enclosed compact design.
 - Quiet & reliable operations.
 - Universal mounting bracket
 - Molded terminal numbers and circuit diagram on top of relay.
- Terminals 1 2 3 4 5 6 (Power)



25-90340

Coil Voltage	Part # DPDT	Coil Resistance DC OHMS ±10%	Nominal Current MA	Nominal VA Sealed	Inrush VA
24	25-90340	15	334	8	21.5
120	25-90341	400	66	8	21.5
240	25-90342	1415	38	8	21.5



Honeywell



Q3200U1004

- Universal 120Vac Hot Surface Ignitor
 - Replaces over 110 ignitor models
 - Next generation silicon nitride design
 - Universal bracket design for improved igniter replacement
 - 3 year Warranty

Honeywell



Q4100C9046

Furnace Hot Surface ignitor silicone carbide. 19-1/8" Leads

Honeywell



Q4100C9054

Furnace Hot Surface ignitor silicone carbide. 5-1/4" Leads

Honeywell



Q4100C9056

Furnace Hot Surface ignitor silicone carbide. 5-1/4" Leads

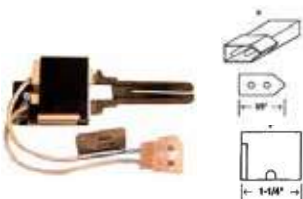

768A-845

Silicone Nitride furnace ignitor. Replaces Trane B340970P01, IGN00104, X13130524010



768A-815

Nitride Hot Surface Ignitor. Replaces Trane 768A-15, A341947P01 54mm ignitor element length



SIG101

Supco Furnace Ignitor. Replaces a variety of OEM ignitors. Silicone carbide for extra strength and durability. Easy installation.

41-412 Carbide (Standard)

Furnace Hot Surface Ignitor. 5-1/4" lead. Popular on Goodman furnaces as well as others.

768A-844

Nitride Hot Surface Ignitor. Replacement for Lennox 41K5601, Rheem 62-24134-02

903758

Nordyne 903758 Hot Surface Furnace Ignitor. Use with G3, G4, G5, G67 M2 Units. Replaces 632-363.

LH33ZG001

Carrier /Bryant style furnace ignitor.



Q3400A1024

Honeywell Ignitor Flame Rod Assembly. 30" lead wire.

75M21

Lennox Furnace Ignitor.

Flame Sensors



51M14

Lennox flame sensor.



52W29

Lennox 52W29 Flame Sensor. Replaces 31L71, 31L7101 & LB-74940A



PFS014

Carrier replacement flame sensor (Flame rod). For use with Q4100C9056 ignitor



10-681

Carrier style replacement flame sensor. Replaces LH33WZ511. Can be used with 41-409 ignitor.



PFS013

Carrier Flame Sensor Rod.



0130F00010

Goodman style flame sensor.



10-227

Replaces Lennox 18G89 Flame Sensor.

Thermocouples

Honeywell



ROBERTSHAW

- 1980-818
- 1980-824
- 1980-830
- 1980-836
- 1980-848
- 1980-860
- 1980-872

HONEYWELL

- Q340A1066
- Q340A1074
- Q340A1082
- Q340A1090
- Q340A1108
-
-

- 18"
- 24"
- 30"
- 36"
- 48"
- 60"
- 72"

Easy install, long life, universal adapter & push-in clip, bottom-lock design for easy bottom install. Thermopile with 750mV millivolt output.

Thermopiles

Honeywell

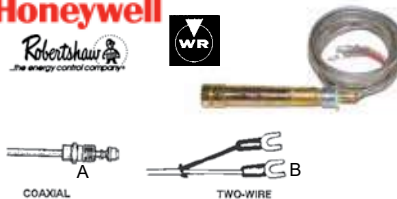

PART #

BRAND

LEN. END

- G01A-132** WHITE RODGERS 35" B
- Q313A1402** HONEYWELL 35" B
- 1950-001** ROBERTSHAW 36" B
- 1951-536** ROBERTSHAW 36" A

Thermopile with 750mV millivolt output.

Honeywell



Q313U3000

Universal thermopile. 35" leads with attaching nut, push-in clip, PG9 adapter. 750mV millivolt output.



Controls

Honeywell



ST9120U1011
Honeywell Universal Electronic Fan Control Easy install, replaces 25 existing controls, integrated control of blower and circulation fan. See web for full crossover list.

Honeywell



S9200U1000
Honeywell Universal Integrated Furnace Control. Includes complete set of wiring harness for universal install. Replaces over 140 controls from most manufacturers. See web for crossover list.

White Rodgers



50A65-843
White Rodgers Universal Nitride Ignition Module. Module will replace all of the 50A65-XXX series that have been manufactured by White-Rodgers. See web for extensive cross over list.

White Rodgers



50A55-843
White Rodgers Universal Hot Surface Ignition Module for Silicon Carbide Ignition. Module will replace most of the 50A5X-XXX integrated ignition carbide modules for most OEM applications. See web for extensive crossover list.

Replaces over 100 Honeywell and competitive products

Honeywell

Part#	Ignition System	Flame Sensor	Ignition Sequence	Ignition Trial Time	Between Trial Time	Pre-Purge	Flame Failure
S8910U3000	Line Volt Surface	1 or 2 Rods	P	4 or 7 sec Field Selec.	96 sec 3 Trial	32 Sec.	1.5 Sec.

Universal Hot Surface Ignition Module. Easy field replacement for most hot surface ignition modules. Single-rod or dual-rod systems. LED diagnostics and field-adj ignition timings. Natural or LP gas. All adaptation acc. incl.

Honeywell



L4064B2228 5"

L4064B2236 8"

L4064B2210 11-1/2"
Honeywell Fan and Limit Controller with 125F fan on and 100 F fan off stops, 200 F high limit. For control of high limit and fan motor in all types of forced air heating systems. With manual fan switch for overrides.

Replaces over 300 Honeywell and competitive products

Honeywell

Part#	Ignition System	Flame Sensor	Ignition Sequence	Ignition Trial Time	Between Trial Time	Pre-Purge	Flame Failure
S8610U3009	Intermit. Pilot	1 or 2 Rods	C	15 or 90 sec Field Selec.	5 min Delay	0 or 32 Sec.	2.0 Sec.

Universal Intermittent Pilot Ignition Module. Easy field replacement for most intermittent pilot modules. Single-rod or dual-rod systems. LED diagnostics helps direct service effort. Field-selectable pre-purge and ignition trial timings. LED flame strength indicator. Integral damper conn.

Transformers

Honeywell



AT72D1725 40VA
Traditional Transformers
This Transformer is 120V primary to 24V secondary voltages. Comes with multi mount, foot, plate or knockout



S82A-310 20VA
S84A-310 40VA - w/mount. plate
Enclosed Transformers
Transformers are 120V primary to 24V secondary volt-ages. 7-10" leads and screw type terminals

Aluminium BLOWER PULLEYS

PART#	BORE	DIAM.
67-650	3/4"	5"
67-660	3/4"	6"
67-670	3/4"	7"
67-680	3/4"	8"
67-690	3/4"	9"
67-610	3/4"	10"
67-612	3/4"	12"



Sheaves

Cast iron, all sheaves are fitted with hollow head set screw. Any standard single groove sheave can be used as a companion sheave. Accurately machined and balanced. For 3L, 4L & 5L belts



IVL44-5/8

67-4350

CAST IRON		ALUM.		O.D.	BORE
PART #	O.D.	PART #	O.D.		
MP-MVL25X1/2	2.5				
MP-MVL25X5/8	2.5"				
MP-MVL30X5/8	2.87"				
MP-MVL30X1/2	2.87"	67-4325	3-1/4"	1/2"	
-	-	67-5325	3-1/4"	5/8"	
MP-MVL34X1/2	3.15"	67-4350	3-1/2"	1/2"	
MP-MVL34X5/8	3.15"	67-5350	3-1/2"	5/8"	
MP-MVL40X1/2	3.75"	67-4375	3-3/4"	1/2"	
MP-MVL40X5/8	3.75"	67-5375	3-3/4"	5/8"	
MP-MVL44X1/2	4.15"	67-4400	4"	1/2"	
MP-MVL44X5/8	4.15"	67-5400	4"	5/8"	

ALL 67-SERIES ARE CAST Aluminium & ARE MANUFACTURED TO O.E.M. SPECIFICATIONS

Ball Bearings

Bearings complete with collar.

Part #	Bore	OD	Replaces
67-4336-2	3/4"	1 13/16"	(2) Bearings & (2) Collars
67-4346-1	1"	2 1/4"	RCR



Sleeve Bearing Paks

Kits include 2 bearings & 2 rubber sleeves.

Part #	Bore	OD	Type	Replaces
67-4036-2	3/4"	1 25/32"	Oil	Delhi
67-4135-2	5/8"	1 7/8"	Sealed	Lau
67-4136-2	3/4"	1 13/16"	Sealed	Delhi
67-4137-2	3/4"	1 13/16"	Sealed	Lau & Lennox
67-4138-2	3/4"	1 7/8"	Sealed	Torin
67-4147-2	1"	2 1/2"	Sealed	Lau & Lennox
67-4148-2	1"	2 1/2"	Sealed	Torin

BLOWER SHAFTS

Slabbed on pulley end, Rust protected

PART#	DIAMETER	LENGTH
67-62000	3/4"	20"
67-82400	1"	24"



Note: For shorter lengths, simply cut off non-slabbled end of shaft



Gas Valves

VR8200H1236 1/2" x 1/2" Slow Opening
VR8200A2322 1/2" x 1/2" Standard
 Honeywell 24VAC standing pilot gas valve.
 - 0F to 175F, 60 Hz
 - Single Stage
 - Natural to LP conversion kit incl
 - 3.5in. wc

Honeywell

Check website for complete selection of gas valves!



Standard
VR8245M2530 1/2" x 1/2"
VR8345M4302 3/4" x 3/4"
 2-Stage
VR8345Q4563 3/4" x 3/4"
 Honeywell universal electronic 24VAC intermittent pilot gas valve.
 -40F to 175F, 50/60 Hz - Natural to LP conversion kit incl
 - 3.5 in. wc (1.7 in.wc in low for 2 stage)

Honeywell



Heat Sequencers

24A34 Series White Rodgers Electric Heat Sequencers
 Direct replacement for most fan/heat sequencing functions.
 - Replaces Honeywell, MARS, TOD, GEMLINE etc...
 - 24V Input control
 - Multi-poise mounting
 - Double quick connect terminals for combo loads
 - Any contacts (except M1/M2) can be used as auxiliary



Air Switches



AS-NS2-0000-03

Universal Air Switch. Diaphragm snap switch design. Can be actuated by pressure or vacuum flow or differential. Can be applied to a variety of residential and light commercial HVAC applications
 Includes
 - Solenoid
 - Variety of Fittings & mounting hardware
 - Variety of orifices, springs and install tools
 - Adjustable switch

ELECTRICAL RATINGS - SINGLE LOAD CONTACT RATINGS (ALL MODELS)

VAC	Resistive (Non-Inductive)		Motor Ratings (Inductive)		Pilot Duty
	Watts	Amps	Full Load	Locked Rotor	
120	3000	25.0	14.0A	72.0A	125 VA
240	6000	25.0	7.0A	42.0A	125 VA
480	6000	12.5	-	-	480 VA

Model Number	Timings	Switches	Timings - ON					Timings - OFF				
			M1-M2	M3-M4	M5-M6	M7-M8	M9-M10	M1-M2	M3-M4	M5-M6	M7-M8	M9-M10
24A34-21	1	1	1-20	-	-	-	-	1-50	-	-	-	-
24A34-22	1	1	15-45	-	-	-	-	1-30	-	-	-	-
24A34-23	1	1	25-55	-	-	-	-	15-45	-	-	-	-
24A34-24	1	1	30-75	-	-	-	-	1-40	-	-	-	-
24A34-25	1	1	40-90	-	-	-	-	1-30	-	-	-	-
24A34-26	2	2	1-20	30-90	-	-	-	40-90	1-30	-	-	-
24A34-27	2	2	1-160	1-160	-	-	-	1-160	1-160	-	-	-
24A34-28	2	2	1-160	1-160	-	-	-	1-160	1-160	-	-	-
24A34-29	1	1	15-35	-	-	-	-	25-55	-	-	-	-
24A34-36	2	2	1-20	30-45	-	-	-	45-110	1-30	-	-	-
24A34-37	1	1	1-110	-	-	-	-	1-110	-	-	-	-

Pneumatic Tubing & Fittings

SIEMENS

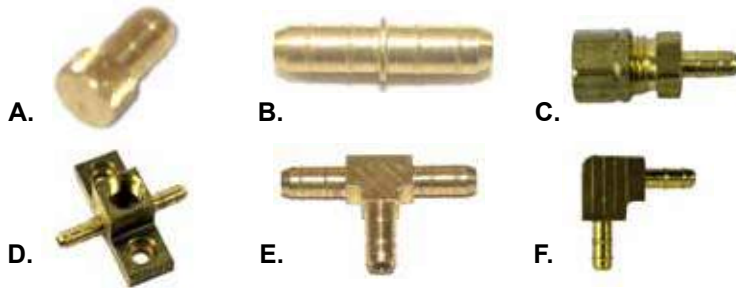

Fig.	Code#	Part#	Description	Tube Size
A	001-578	F-1000-323	Barb Plug	1/4" & 5/32"
A	--	F-1000-396	Barb Plug 10/pkg	1/4" & 5/32"
A	001-573	F-1000-241	Barb Plug	3/8"
B	001-574	F-300-30	Barb Union Reducer	1/4" x 5/32"
B	001-575	F-300-35	Barb Union	5/32"
B	001-552	F-300-26	Barb Union	1/4"
B	001-556	F-300-21	Barb Union	1/4" X 3/8"
B	001-565	F-300-27	Barb Union	3/8"
C	001-571	22CA-4-4	Barb X Compression Union	1/4" x 1/4"
D	--	F-700-80	Barb Adapter Tee	1/4" x 1/8"
E	001-576	F-700-83	Union Tee	5/32"
E	001-554	F-700-73	Union Tee	1/4"
E	001-548	F-700-84	Union Tee	1/4" x 1/4" x 5/32"
F	001-549	F-500-45	Elbow	5/32"
F	001-569	F-500-39	Elbow	1/4"

Robertshaw
 the energy control company



2374-510

Robertshaw Universal Air Pressure Sensing Switch. Can be actuated by negative or positive air flow or differential. Can be applied to a variety of residential and light commercial HVAC applications.
 Contents
 - Air Pressure Sensing Switch- Calibration Springs (5 options)- Orifice Flows (4 Options)- Mounting Brackets (2 Options)- Calibration Tool (Hex Wrench)

Robertshaw
 the energy control company



2374-500

Robertshaw Dual Purpose Air Switch. Responds to Positive, Negative or Differential Air Pressure. c/w 1/4"OD x 6" flex tubing, nuts and ferrules. Enclosed diaphragm.

SIEMENS

1219-13004

Sold per foot but must order full roll



1219-130T4

Part#	O.D.	\$/ft.
1219-13004	5/32"	
1219-44003	1/4"	
1219-66203	3/8"	
Twin Tubing		
1219-130T4	5/32"	
1219-440T3	1/4"	

Pneumatic flame retardant poly tubing. 150F max temperature.

Thermostat

**A19 Remote Bulb/Coiled Bulb
Wide Range - Adjustable Differential - Aqua-stats**

Part#	Switch	Range	Diff.	Bulb	Adjuster	Electrical Ratings
A19ABC-4C	SPDT	50 - 130°F	3-14°F	3/8"X5" bulb	Knob	16A/120-8A/240
		10 -55°C	1.9 - 8°C	8' Capillary Tube		
A19ABC-24C	SPDT	-30 - 100°F	3 -12°F	3/8"X4" bulb	Convertible	16A/120-8A/240
		-34 - 38°C	1.7 - 6.7°C	8' Capillary Tube		
A19ABC-36C	SPDT	-30 - 100°F	3 -12°F	3/8"X4" bulb	Convertible	16A/120-8A/240
		-34 - 38°C	1.7 - 6.7°C	20' Capillary Tube		
A19ABA-40C	SPST	-30 - 100°F	3 -12°F	3/8"X4" bulb	Convertible	16A/120-8A/240
		-34 - 38°C	1.7 - 6.7°C	6' Capillary Tube	Screwdriver Slot	



Fixed Differential - Aqua-stats

Part#	Switch	Range	Diff.	Bulb	Adjuster	Electrical Ratings
A19AAF-12C	SPDT	25 - 225°F	3.5°F	3/8"X3" bulb	Screwdriver	6A/120-3A/240
		-4 - 107°C	1.9°C	10' Capillary Tube	Slot	

Manual Reset

Part#	Switch	Range	Diff.	Bulb	Adjuster	Electrical Ratings
A19ACA-14C	SPDT	-30 - 100°F	Manual	3/8"X4" bulb	Screwdriver	16A/120-8A/240
		-34 - 38°C	Reset	8' Capillary Tube	Slot	
A19ACA-15C	SPDT	-30 - 100°F	Manual	3/8"X4" bulb	Screwdriver	16A/120-8A/240
		-34 - 38°C	Reset	10' Capillary Tube	Slot	

High Temperature

Part#	Switch	Range	Diff.	Bulb	Adjuster	Electrical Ratings
A19AAC-9C	SPDT	100 - 240°F	5°F	3/8"X3 7/8" bulb	Screwdriver	16A/120-8A/240
		-34 - 38°C	2.8°C	8' Capillary	Slot	

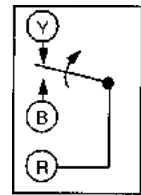

Action on increase of temperature

Bulb Well part# **WEL14A-602R** - For A19AAF-12C/A19ACA-14C/A19AAC-9C

Coiled Bulb

Part#	Switch	Range	Diff.	Bulb	Adjuster	Electrical Ratings
A19BBC-2C	SPDT	-30 - 100°F	3 - 12°F	1 3/8" x 2 1/4"	Convertible	16A/120-8A/240
		-34 - 38°C	1.7 - 7°C	Coiled		

Wide range temperature control with air coil sensing element. Wide range temperature, NEMA 1 enclosure.

Applications: Return air or space temperature sensing



A421ABC-02C

Electronic Temperature Controls - Single Stage A421 Series - Aqua-stats

Part#	Switch	Range	Diff.	Cable	Adj.	Electrical Ratings
A421ABC-02C	SPDT	-40 - 212°F (-40 - 100°C)	+5°F/3°C	6'7" cable 2"probe	Digital	120/240V 16A
A421GBF-02C	SPDT	-40 - 212°F (-40 - 100°C)	+5°F/3°C	6'6" cable 2" probe	Digital	24V 50/60hz



V-9999-608
Johnson Controls packing kit. Fits V/VB/AV/VT series valve bodies.





V-3000-6000
Johnson Controls Diaphragm. For exposed actuator V-3000-1.







V-3100-611
Johnson Controls Diaphragm. For V-3802-1 actuator.







T-4002-9008 Horz. Celsius
T-4002-201 Horz. Fahrenheit
Johnson Controls Direct Acting Heat/Cool 2-Pipe Pneumatic Thermostat. Horizontal. Single set point. Field adjustable. High volume. **Cover and mounting bracket sold separate.**







T-4000-2139 Beige, Concealed Set Point & Temperature
T-4000-2142 Beige, Visible Set Point & Temperature*
Johnson Controls Pneumatic Horizontal Thermostat Covers. *shown





T-4002-124
Johnson Controls Thermostat Mounting Bracket. For T-4000 series thermostats.





T-4100-103
Universal Wallplate Adaptor Kit mounts on standard electrical wallbox and some competitors' hardware.







192-850

Retroline Kits (Cover, Chassis, Hardware) Heating Only

PART#	PIPES	ACTION	DESCRIPTION
192-850	2	D/A	Almond, Celsius
192-851	2	R/A	Almond, Celsius
192-850W	2	D/A	White, Celsius

Part# Description
Single set point cooling thermostat

192-220	1 pipe celsius D.A.
192-222	2 pipe celsius D.A.
192-223	2 pipe celsius R.A.

Dual set point heating thermostat

192-224	2-3 pipe celsius D.A.
192-226	2-3 pipe celsius D.A. w/night vent



SIEMENS

Complete Thermostat Kits

Pneumatic Thermostat Parts

SIEMENS PARTS

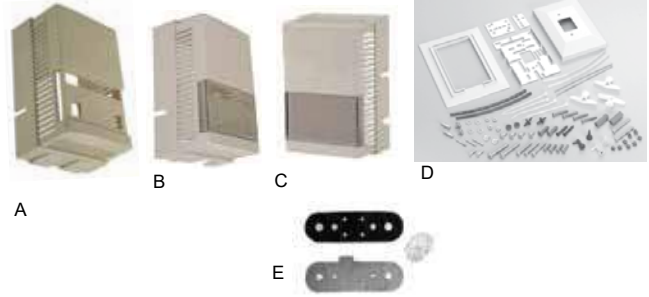

Part#	Description	Fig.
192-868	Retrostat plastic thermo. cover, Desert Beige	A
192-252	Plastic Thermo. cover Adjustments exposed	B
192-252W	Plastic Thermo. cover Adj. exposed white	B
192-256	Plastic Thermo. cover Adjustments not exposed	C
192-300	Universal Mounting Kit repl. competitors thermo., Desert Beige	D
192-300W	Universal Mounting Kit repl. competitors thermo., White	D
192-321	Restrictor Plate kit, enough for 10 thermostats	E

SIEMENS



832-178
Siemens calibration tools for 180, 182, 192 and 832 thermostats.



192-633
Siemens needle probe, gauge and cover wrench



192-623 5/pk
Siemens allen wrench kit

Don't forget
to login to see
wholesale pricing
www.amresupply.com



192-632 5/pk
Powers adjustment key. Opens covers and changes setpoint



856-055
Siemens calibration and cover screw wrench with Pocket Clip

832-177
Siemens complete calibration kit for 180, 182, 192 and 832 thermostats. Includes gauge, squeeze bulb, thermometer & fittings for testing thermostats, valves and damper actuators.



MT Pneumatic Valves



Siemens Powermite Two Way/Three Way MT series Valves Normally Open, single seated pneumatic valve, straight thru or angle body construction provides proportional control of two pipe hot water or 15 psig low pressure steam systems. Interchangeable with pneumatic or electronic actuators. Valve bodies have spring built in. There are no repair parts for the valve body, replacement only.

SIEMENS



599-01088
Pneumatic MT Series 2" valve actuator. Available separately

Complete Valves (Female NPT X Union Male bodies)/Normally Open, Two Way

PART#	Pipe Size	Valve Body	Spring Rating	Cv Rating	Fig.
257-02039	1/2" NPT	599-02039	3 to 8psi	2.5	A
257-02042	1/2" NPT	599-02042	3 to 8psi	4.0	A
257-02045	3/4" NPT	599-02045	3 to 8psi	6.3	A

Complete Valve (Female NPT X Female NPT bodies)/Normally Closed, Two Way

PART#	Pipe Size	Valve Body	Spring Rating	Cv Rating	Fig.
256-02008	1/2" NPT	599-02008	10 to 15psi	2.5	N/I

Complete Valve (Female NPT X Union Male Bodies)/Normally Closed, Two Way

PART#	Pipe Size	Valve Body	Spring Rating	Cv Rating	Fig.
256-02011	1/2" NPT	599-02011	3 to 8psi	4.0	A

Complete Valves (Female NPT X Female NPT) Three Way

PART#	Pipe Size	Valve Body	Spring Rating	Cv Rating	Fig.
258-02069	1/2" NPT	599-02069	8 to 13psi	4.0	B
258-02070	3/4" NPT	599-02070	8 to 13psi	6.3	B

24 HR.



Order by
4pm for
24-48hr shipping
to almost anywhere in
Canada!

Kits

Convertastat Kits Honeywell

Convertastat Kits (Covers, Chassis & Hardware) One Setpoint, Celsius. Used to replace old style and competitive thermostats

PART#	PIPES	ACTION	DESCRIPTION
TP970A2234	2	D.A.	Kit
TP970B2150	2	R.A.	Kit

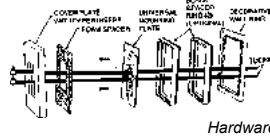

Hardware



305965
Gauge for testing thermostats

Thermostat Chassis Honeywell

Chassis only (One Setpoint) Celsius
Order cover separately

PART#	PIPES	ACTION	DESCRIP.
TP970A2020	2	D.A.	Chassis only
TP970B2010	2	R.A.	Chassis only
TP973A2084	1/2	D.A.	Low cap., restrictor req.



Honeywell



CCT735A
Honeywell Thermostat tool



CCT729A
Honeywell Gauge Adapter

Honeywell PARTS Pneumatic Thermostat Parts

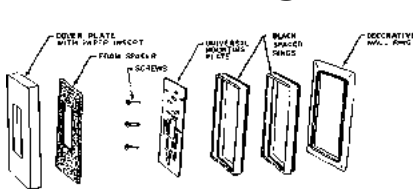

14002573-001 1/2 pipe
This universal adaptor kit is needed when replacing an older style Honeywell thermostat or a competitors thermostat with the TP970 Series thermostats. This universal adaptor is also included in the Converastat TP970 thermostat kit

Honeywell



Honeywell VP525 series Pneumatic Radiator Valves
Normally Open, single seated pneumatic valve with straight thru or angle body construction provides proportional control of two pipe hot water. Easily replaceable actuator assembly, compact size, can be repacked without shutting down. Max Medium Temp. 180°C

PART#	Pipe Size	Valve Pattern	Spring Rating	Cv Rating
VP525C1016	1/2" NPT		3-10psi,2-5psi	2.0
VP525C1073	1/2" NPT	Integral Seats	3-10psi,2-5psi	3.0
VP525C1024	3/4" NPT		3 to 10psi	3.0
VP525C1032	3/4" NPT		3-10psi,2-5psi	5.0

*All valves are straight, male union

Honeywell



14003102-001
Replacement Top Assm.

**We are a
Pneumatic Parts
Distributor for:
Honeywell**

Honeywell PARTS Pneumatic Thermostat Parts

Part#	Description	Image
14004406-110	Thermostat Cover Satin Chrome 15-30C	D
14004406-310	Thermostat Cover Satin Chrome 15-30C (Two windows)	D
14004407-110	Thermostat Cover, Plastic, Beige 15-30C	D
14004447-001**	Thermostat Black Cam Wheel (TP970A, C, TP972A*)	B
14004447-002**	Thermostat Black Cam Wheel (TP970B,D, TP972A*)	B
14004460-001**	Bimetal Assm., Nozzle & Throttling Plate (TP970A, TP971A, C, D TP972 - D/A Left side)	C
14001865-001	Filter Cartridge Assm (TP9600, TP970, TP971,TP972, TP973)	A
14002374-004	Restrictor Block Assm. 0.005 includes 14004419-001 gasket (TP970, TP971, TP972)	E
14004459-001	Scaleplate Bag Assm. 60F-90F (TP970, TP973)	F



* Check model when replacing cam wheel on TP972A Heating/Cooling Thermostats
** Always replace the setpoint cam assm. and the nozzle, throttling plate, bimetal assembly together

Honeywell PARTS

(refer to service data 75-5544) Common repair parts for VP525 Valves
Valve rebuild kits:

Part#	Description
14003115-001	For 1/2" 2 Cv Valves
14003116-001	For 3/4" 2 Cv Valves
14003117-001	For 3/4" 3 Cv Valves
14003118-001	For 3/4" 5 Cv Valves
14003119-001	For 1/2" 3 Cv Valves
14003299-001	For 5/8" O.D. S. Body Valves
14003300-001	For 7/8" O.D. S. Body Valves





Honeywell



315917
Diaphragm
Honeywell O.E.M. Valve repair parts for VP526, VP527, & Valves VP531 Series Valves



CSC-2007 14.4 SCIM@20PSIG
CSC-2003 11.5 SCIM@20PSIG
 Reset Volume Controller, DA / N.O. w / Bracket



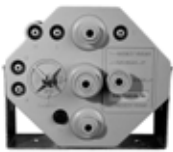

CSC-3011-10
 Reset Volume Controller, 0-1" range, 8 psig start, "universal"



HPO-0038
 KMC replacement diaphragm for MCP-3631 series pneumatic damper actuators.

HPO-5114 (005-400-01)
 KMC Diaphragm for VCP11/21/34 series pneumatic control valves

VTD-9422 2" (007-400-01)
VTD-9423 3" (013-400-01)
VTD-9424 4" (010-400-01)
VTD-9426 6" (016-400-01)
 KMC Diaphragm for pneumatic actuators





HPO-5030 1/2" 2.0CV
HPO-5032 3/4" 2.9CV
HPO-5033 3/4" 4.7CV
 KMC Replacement Bonnet assembly for electric zone control valve series VEP-11/12/21/22



Part#	PSI	Size	Series
MCP-0203	5-10PSI	2"	MCP-1020
MCP-0303	5-10PSI	3"	MCP-1030
MCP-0305	8-13PSI	3"	MCP-1030

KMC Actuator replacement bare actuator for MCP series pneumatic damper actuators. Other models available.





Scale plate assembly and cover are required and sold separately

CTC-1621 Direct Acting
CTC-1622 Reverse Acting
 KMC 2 Pipe Pneumatic Thermostat. For proportional control of pneumatic valve and damper actuators. Scale plate assembly and cover are required and sold separately. Field adjustable. Setpoint Range 55 to 85F(13 to 29C) Throttling range 3 to 12F(1.7 to 6.7C)

HMO-5030 Light Almond
HMO-5031 White
 KMC Backplate Kit. 2.75" x 4.5" plate to fit 2x4 handy box. Screws included.

HPO-0047-10 F Horizontal
HPO-0048-10 F Vertical
HPO-0049-11 C Horizontal
HPO-0050-11 C Vertical
 KMC Thermostat Scale Plate. Includes 2 HPO-0046 scale plate pins.

HPO-1511 Light Almond
HPO-1512 White
 KMC Full Window Thermostat Cover. Plastic. Other styles available including metal and blank covers.

MCP-80313101 Bronze Bushing w/Clevis and Cotter Pins
MCP-80313102 Plastic Bushing Without Clevis or Cotter Pins
MCP-80313003 Plastic Bushing w/Clevis and Cotter Pins, no Mount Bracket

KMC Actuator - 5-10 psi Range Damper Actuators. Other PSI ranges available. Actuator can be rotated in bracket. Right angle bracket included except 3003 model. Metal body.



MCP-36313000
 KMC Actuator - 5-10psa Rotary Pneumatic Damper Actuator. For use on VAV terminal units and other small dampers. For 1/2" diameter shafts. (3/8" adapter avail. sep HLO-1011) Can be rotated. Other PSI ranges available.









Part #	Sensing points	Length
SSS-1002*	One	3-5/32"
SSS-1003	Two	5-13/32"
SSS-1004	Three	7-21/32"

KMC Differential Pressure Flow Sensors 1/4" connections for 3/8" OD polyethylene tubing

RCC-1502
 8 psi calibration
 KMC Adjustable Reversing Relay with bracket
 A bias adjustment of +/- 15 psi (103 kPa) is provided to retard or advance the output

CMC-1001
 KMC Non-Metallic Positive Positioner. Designed to be used with actuators containing an 8 to 13 psi spring so that equal force can be obtained on both power and return strokes

MEP-5061
 18"/minute Actuator
 KMC Direct-Coupled, Tri-State, ControlSet® Actuators (50 in-lbs.)
 Adjustable end stops, Gear disengagement button for manual positioning

Hydronic Zone Valves



1/2" O.D. Flare



NPT (Inverted Flare)

Hydronic Zone Valves - Honeywell

Most Common Honeywell Zone Valves, No End Switch

Part #	Description	Configuration
V8043C1116	1/2" O.D. Flare, adapters sep.	Normally Closed
V8043D1197	1/2" O.D. Flare, adapters sep.	Normally Open
V8043D1064	3/4" Sweat	Normally Open

Common Zone Valves, with end switch

Part #	Description	Configuration
V8043G1034	1/2" O.D. Flare, adapters inc.	Normally Closed
V8043G1018	3/4" Sweat, 3.5 cv	Normally Closed
V8043G1125	1/2" NPT (Inverted Flare)	Normally Closed

Honeywell Zone Valves, can be used to replace Erie, White Rodgers Mutt and EMC

Part #	Description	Configuration	PSI
V8043C3310	1/2" NPT (Inverted Flare)	Normally Closed	300
V8043D3318	1/2" NPT (Inverted Flare)	Normally Open	300
V8043C1124	1/2" NPT (Inverted Flare)	Normally Closed	125
V8043D1205	1/2" NPT (Inverted Flare)	Normally Open	125
V8043D1031	3/4" Inverted Flare	Normally Open	125

Honeywell Replacement Heads

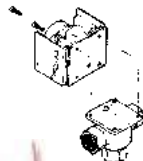

New Style Replacement Heads

- 40003916-011 Fits V8043A and C series
- 40003916-012 Fits V8043E and G series
- 40003916-014 Fits V8043D series

*If you have old style valves, you are required to purchase an adapter part# 40003918-002.

Honeywell

Erie now offers the ability for contractors & property owners to stock valve bodies & operating heads separately. This can reduce your inventory costs & increase selection. Same Erie quality, more versatility!



AG13A020



VT2343



A. Most common Erie Zone Valve Operating Head, No end switch

Part #	Description	Configuration
AG13A020	24 volt operating head, no switch	Normally Closed
AG23A020	24 volt operating head, no switch	Normally Open

Most common Erie Zone Valve Operating Head, With end switch

Part #	Description	Configuration
AG13A02A	24 volt operating head, with switch	Normally Closed
AG23A02A	24 volt operating head, with switch	Normally Open

B. Most common Erie Zone Valve Bodies

Part #	Description
VT2343	3/4" Inverted flare valve body, 2 way
VT3343	3/4" Inverted flare valve body, 3 way

Hydronic Zone Valves/Motor

Honeywell
We also carry replacement valve heads, o-rings, and rubber paddles



Zone Valve Adapters

436-252 3/4" Inverted Flare & Coupling. Adapter Fits Erie, EMC, & Mutt Valves, sold individually



Honeywell

272704B

V8043 ZONE VALVE ADAPTOR

Set of 2
272704A
Adpt. 3/8" Flare - 1/2" Sweat
272704B
Adpt. 3/8" Flare - 3/4" Sweat

Zone Valve Motors

New!

Honeywell



272742A

Honeywell Ball Plug Kit. Use with 8043 Series zone valves

New!

Honeywell



40003918-002

Honeywell Head Adapter Kit. Convert straight through (two-way) non-removable head style zone valves to removable head style.



272748AB HONEYWELL

30-118-A ERIE
Electric Zone Valve Motors, Fits Most Brand Names, Erie, Flair, Honeywell, EMC



TIPS

Normally Open

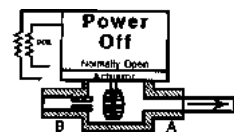

Normally Closed

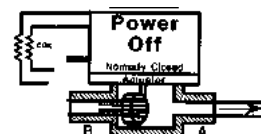



Amre is a proud distributor of Belimo products.
Give us a call
 visit instore or online
www.amresupply.com



Belimo Actuators, Dampers, VAV and Valves
 Our most popular including the new generation AFB series
Spring Return

PART	TORQUE	POWER SUPPLY	CONTROL INPUT
AFB24-MFT	180in-lb	24VAC/DC	2-10VDC
LF120US	35in-lb	120VAC	ON-OFF
LF24-SRUS	35in-lb	24VAC/DC	2-10VDC, 4-20ma
TF120US	18in-lb	100-240VAC	ON-OFF
Non Spring Return			
GMB24-3	360in-lb	24VAC/DC	ON-OFF-FLOATING POINT
AMB24-SR	180in-lb	24VAC/DC	2-10VDC, 4-20ma
NFBUP	90in-lb	24-240VAC	ON-OFF
LMB24-3	45in-lb	24VAC/DC	ON-OFF-FLOATING POINT

Popular Accessories

ZS-100	Weathershield 13"L X 8"W X 6"D
WAF-US	Valve linkage for AF actuators
WLF-US	Valve linkage for LF actuators
WTF-US	Valve linkage for TF actuators



AMRE is proud to be a full line Taco distributor!



Enjoy the soothing convenience and **comfort of hot water**
 Save water, energy and money with **On Command™**

Call Click or Come In to learn more





V241-12N
1/2" Female Inlet and Union Outlet

V241-34N
3/4" Female Inlet and Union Outlet
Spartan 2-Way Zone Control Valve Body. Use EB, EP or EV series cartridges sold separately. For hot and chilled water and 50% glycol. Compatible with complete line of Spartan control valve actuators.



V243-12N 1/2" Female Inlet and Outlet
Spartan 2-Way Zone Control Valve Body. Use EB, EP or EV series cartridges sold separately. For hot and chilled water and 50% glycol. Compatible with complete line of Spartan control valve actuators.



EP2.5 2.5cv
EP3.5 3.5cv
EP4.5 4.5cv
Spartan Zone Valve Cartridge. For 2 way V200 and V300 series valve bodies, for hot or chilled water and 50% glycol. Other cv's available.



EV3.5 3.5CV
Spartan EP series cartridge for V200 & V300 series 2-way valve bodies. Used for low pressure up to 15PSI steam applications. Other CV ratings available.



ME4430 Normally Open Stem Up 24V
ME4431 Normally Open Stem Up 110V
ME4530 Norm. Closed Stem Down 24V
ME4531 Norm. Closed Stem Down 110V
Spartan Spring Return Zone Valve Electric Actuator
Use with V200 & V300 series valve bodies sold separate
High strength glass filled nylon composite electric gear motor
Easy thread on install
Fail safe on power disruption



ME8200
Spartan Wireless Modulating Actuator
Non spring return, 24Vac
Works with all Spartan valve bodies
See web for full spec's



TE8200
Spartan Wireless Modulating Thermostat
24V or Battery operated
Controls Spartan ME8200 wireless valve actuator
Up to 90ft range, 5C-35C control



ME1607 Normally Open (Stem Up)
ME1707 Normally Closed (Stem Down)
Spartan Compact Thermolectric Spring Return Actuator. 24V Direct Acting. Highly refined wax filled element with piston/stem and patented packless elastomer seal. Silent, extremely compact, inherently fail safe and can operate on hot and cold water, and low pressure steam to 15PSI.



OT1100
Spartan self acting thermostatic Actuator, direct coupled. For control of hot and chilled water and low pressure steam. 5-30C. Compatible with V160, V240, 1,3,5, V320,5 and V420 bodies, BC, EB, EP and EV cartridges.



AV08
Spartan cartridge, packing and union tool. Will remove 1/2", 3/4", 1" and 1-1/4" sizes. Can also be used to keep the EB type cartridges in place when removing actuator.



Amre is a full line distributor for Spartan Peripheral Devices. Spartan is a Canadian manufacturer with a long history of providing innovative, dependable products to the HVAC industry.

Please visit www.Spartan-PD.com to see a full listing of products available through
Amre Supply
Valves . Actuators . Thermostats and more...



HEATING CONTROLS

**Honeywell
Braukmann**



T104A104 8C-28C/46F-83F
Honeywell direct mount controls for V110 valve bodies. These valve controls require mounting in a horizontal position. The T104V1422 is vandal resistant. Must be used with V110 Series Valve Bodies



Order by **4pm** for **24-48hr shipping** to almost anywhere in Canada!



CA100A
Cartridge



CA110C

**Honeywell
Braukmann**

CA110C107 V110
CA100B1008 V100, metal
CA100A116 V100, plastic
Honeywell replacement cartridges for V110 and V100 valve bodies. Please make sure to know the valve body style when ordering.



013G8250 Regular
Danfoss direct mount controls for RA2000 valve bodies only. These valve controls require mounting in a horizontal position. If you have a RA style valve, a **013G8070** adapter must be ordered at same time. If you have a RAV valve body, a **013G8072** adapter must be ordered at same time

Danfoss Adapter



A



B

Danfoss

Part#	Description	Fig.
013G8070	RA Style Valve	A
013G8072	RAV Style Valve	B

NO. 66, 67 and 68 Auto-Vents and Accessories

MAIDOMIST®



NO.67



9AS

Float-operated vents for installation on convector radiators, baseboard radiation, and radiation panels. Designed for use where space is limited, the No. 66, 67 or 68 Auto-Vents with their small overall size may be installed in trouble spots previously neglected or improperly vented. For use on systems with pressures up to 50 lbs. No air required.

PART#	DIMENSIONS	DESCRIPTION
NO.67	3 3/4" x 1 9/16"	1/8" I.P. Male connection, 50 psi
NO.66	2 5/8" x 1 1/2"	1/8" I.P. Male connection, 50 psi
9AS	"Shortstop" Auto Shutoff for #66, 67 & 68	

NO. 7 SERIES Auto-Vents

MAIDOMIST®



NO.7



NO.71

For continuous venting of hot water heating systems & chilled water cooling systems. Install on mains, pipe lines, unit heaters, chillers, convectors, radiant panels, & coils. The No. 7 Series Auto-Vents are reliable automatic air eliminating valves for concealed radiators, pipe lines, tanks, and other devices where water or liquids are used for heating or cooling. The No. 7 Series of Auto-Vent Air Eliminators are made of brass and equipped with a self-closing, float operated valve.

PART#	DIMENSIONS	DESCRIPTION
NO.7	4 3/8" x 2 1/4"	1/8" I.P. Female conn., 75 psi
NO.71	4 3/8" x 2 1/4"	1/4" I.P. Male conn., 150 psi
NO.75	4 3/8" x 2 1/4"	1/2" Female, 3/4" male comb., 150 psi
NO.78	4 3/8" x 2 1/4"	1/8" I.P. Male conn., 75 psi

NO. 27 & 37 Auto-Vents

MAIDOMIST®



For automatically venting radiators, convectors, fan coil units, or baseboard radiation, as well as high points of overhead mains, radiant panels and small unit heaters where water is used for heating or cooling. No air chamber is necessary.

PART#	DIMENSIONS	DESCRIPTION
NO.27	3" x 2 1/2"	1/8" I.P. Female side conn., 50 psi
NO.37	3" x 2 1/2"	1/8" I.P. Male bottom conn., 50 psi

NO. 72 Auto-Vents

MAIDOMIST®



For convectors, baseboard and free-standing radiation. For vertical or horizontal mounting. The No. 72 Auto-Vent is a fast venting valve of the expansion type.

PART#	DIMENSIONS	DESCRIPTION
NO.72	1 1/4" x 1/2"	1/8" I.P. Male connection, 75 psi

Automatic Vent Valve

WATTS INDUSTRIES



0590712 (HAV-1/8) 1/8" IPS
 • Hot water and steam vent designed for automatic or manual air release on base boards, connectors, radiators and high points in piping system
 • Suitable for water
 • Max. steam rating 10 PSI
 • Working temp. range 140°F to 240°F
 • Working pressure range 1.45 to 125 PSI

Automatic Air Vent



113222
 • Float type automatic air vent
 • Removes accumulated air
 • Increases heat transfer and comfort
 • Reduces noise in the system
 • Increases life of system equipment
 • Anti-Rotation & Anti-Vibration float system

WATTS INDUSTRIES

0590715



FV-4M1
0590715 1/8"
0590716 1/4"
 • Provides automatic air venting for hot or cold water distribution systems
 • Purges air that may be in water system
 • Can also operate as an anti-vacuum device
 • Min. working pressure 1.45 PSI, max working pressure 150 PSI
 • Max. working temperature 240°F

Honeywell



Part#	Conn. Size	Max. Operating Temp.
EA122A1002	1/8" MPT	230°F

- Built-in shut off valve for servicing without system shut down
- Removable float/valve assembly
- Safety drain connection cap
- Leakage guard vent cap
- Maintains quiet and efficient operation
- Not suitable for steam systems



- 1BN317** (PT-5) 2 gal
- 1BN318** (PT-12) 4.4 gal
- 1BN319** (PT-25V) 10.3 gal

Potable Water (Drinking water) Residential/Commercial Expansion Tanks. 150PSI for PT-5 & 12, 100PSI PT-25V. Heavy duty butyl diaphragm and poly liner. Max temp 200F (93C) Other sizes available on request. 317/318 3/4" NPTM, 319 3/4"NPTF connection.

- 1BN326** (HFT-15) 2 gal
- 1BN327** (HFT-30) 4.4 gal
- 1BN328** (HFT-60) 7.6 gal

Non-Potable Water (Heating water) Residential/Commercial Expansion Tanks. 1/2" NPTM connection. 100PSI, Max 240F (115C). Heavy duty butyl diaphragm. Carbon steel shell. Other sizes available on request.



- 112111** 3/4" NPT
- 112112** 1" NPT
- 112113** 1-1/4" NPT
- 112117** 1-1/2" NPT

Bell & Gossett EASB-JR enhanced air separator. Automatic removal of air bubbles in residential and commercial hydronic systems. Includes a bottom 1/2"NPT connection to accommodate a diaphragm expansion tank.



Flow Switches

- 113601** FS1-W
- 114550** FS4-3D w/2 SPDT switches
- 114760** FS5-3/4



- 0858535 (AS-1W)** 1"
- 0858536 (AS-114)** 1-1/4"

Watts air scoops are designed for efficient air separation of air from hydronic heating. They have tappings for the installation of an air vent and expansion tank.



- 401440** Hoffman 40 Angle Steam Radiator Air Valve, 1/8"M NPT



- "LWCO"** Low Water Cut Offs
- Hot Water Electronic
- 144676** RB-120



- Level Controls**
- 176234** PS851-M-120

Air Bubbles come in many sizes



- VTP050FT** 1/2"
- Spirotop® Brass Quick Air Releasers. For quick filling & draining. When used in conjunction with a Spirovent no further air bleeders are required. 1/2" FNTP female, brass body, 150 psi.



- (Horizontal design)
- VJR075TM** 3/4"
- VJR100TM** 1"
- VJR125TM** 1-1/4"
- VJR150TM** 1-1/2"

- (Vertical design)
- VJV075FT** 3/4"
- Spirovent® Junior Brass air eliminators for separation and venting of all air in smaller installations.
- FT = Female Threads, TM = FT w/ 1/2" tank mount.



- 144692** RB-24 (24V) (manual reset)



- 114400** FS4-3 Liquid Flow Switch 1"MPT w/2 SPDT switches
- 305200** FS4-33 Replacement SPDT switch
- 336101** FS4-15RP Stainless Steel Paddle Kit, 1" & 6"
- 310451** FS4-15SS Paddle Kit, 1", 2", 3" & 8"





W.C. Bell and E.J. Gossett formed Bell & Gossett in Chicago in 1916 to manufacture and sell case hardening compounds, adding potable water heaters two years later. This direction set the course for B&G to become one of the world's leading manufacturers of pumps, valves, heat exchangers and accessories for plumbing, wastewater and HVAC applications



Bell & Gossett Bearing Assemblies

Genuine Bell & Gossett bearing assemblies for Iron and Bronze Pumps

IRON

Part#	Description	Application	Size
118844	Bearing for Iron Pumps	For model 106189, Series 100	2-5/8"
189105	Bearing for Iron Pumps	For models 102226, series HD-3, PR, 2-1/2, LD3	3-7/8"
186863	Bearing for Iron Pumps	For models 172513/172516/172518, Series PD35/PD37 6"	

IRON/BRONZE

185260	Bearing for Iron Pumps	"A" series; 60 series pumps	6-1/2"
189163	Bearing for Bronze/Iron Pumps	For models 102210/102213/102214, Series HV, 2NFI	4-1/4"

BRONZE

189034	Bearing for Bronze Pumps	For model 106192, Series 100	2-5/8"
189165	Bearing for Bronze Pumps	For model 102213, Series HV	4-1/4"

Wet Rotor Pumps

The bell and Gossett NRF22 style "Fox" pumps are single speed, fit 3/4" to 1-1/2" lines, have a 1/25 H.P. motor and polypropylene impeller

103417	Iron
103357	Bronze



Standard Three Part Pumps

For use in hydronic heating & cooling systems, potable water system use Bronze models, multi stage zoning & general industrial use Iron models

Iron, Single Phase, 115V			
Part#	H.P.	Series	Size (In.)
106189	1/12	100	3/4 - 1 1/2
102210	1/6	HV	3/4 - 1 1/2
102214	1/6	2	2
102218	1/4	2 1/2	2-1/2
102222	1/4	LD-3	3
102226	1/3	HD-3	2
102227	1/3	HD-3	3
Iron, Single Phase, 115/230V			
Part#	H.P.	Series	Size (In.)
105089	1/2	PD35	3
105097	3/4	PD37	3
Bronze, Single Phase, 115V			
Part#	H.P.	Series	Size (In.)
106197	1/12	100	3/4 - 1 1/2
102213	1/6	HV	1 - 1 1/2
102224	1/4	LD-3	3

* Note: Models up to, but not including 2" come without flanges. You must order flanges separately for these models if required.

Bell & Gossett Impellers



Part#	Type	A	B
189132	Plastic	1-3/8"	2-3/4"
118431	Brass	1-3/8"	2-3/4"
118436	Brass	1-1/4"	3-3/8"
118668	Steel	1-1/4"	3-3/8"
118439	Brass	2-1/2"	4-1/4"
118440	Brass	2-1/2"	3-7/8"
118629	Steel	2-3/8"	5-1/4"
118627	Brass	2-3/8"	4-3/4"
118630	Steel	2-3/8"	4-3/4"

Bell & Gossett Motors (powerpacks)

Genuine Bell & Gossett motors, 1725 RPM, Single Phase



Part#	H.P.	Volts	Rotation
111034	1/12	115V	CW
111061	1/6	115V	CW
111031	1/6	115V	CW
111040	1/4	115V	CW
111042	1/3	115/230V	CW
111044	1/2	115/230V	CCW
111047	3/4	115/230V	CCW

Bell & Gossett Pump Couplers

Part#	Type	Size	Used On Models
118705	Cast	1/2"	106189, 106192, 102210, 102213, 102214
118723	Cast	1/2"	2-1/2", 3" LD & 3" HD
118473	Cast	1/2"	PD35, PD37, 172513, 172516, 172518



Part #	HP	Shaft
10010	1/3 to 1/2	1/2"x1/2"
10023	1/2 to 3/4	1/2"x1/2", 1/2"x5/8"
10034	1	1/2"x5/8", 5/8"x5/8"
10045S	1/4 to 1	1/2" or 5/8"

Easy Link Pump Couplers. An alternative design to OEM styles. Compensates for shaft misalignment, absorbs starting torque, Super flexibility.



Bell & Gossett Gaskets

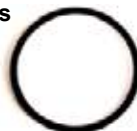

Part#	Type	Size
P04080	Body	3-1/8"
P04890	Body	3-7/8"
P05800	Body	4-3/4"
P57410	Body	5-19/32"
P57700	Body	7-7/8"

Bell & Gossett Bearing Kits for Pumps



Part#	Description
118681	Seal Kit #7 for 100, 1", 1-1/4" 1-1/2", 2", HV, PR, 2-1/2", LD3" HD3", PD35, PD37
186499	Seal Kit #2 for PD38, PD39, PD40



Armstrong offers a wide range of high-quality replacement parts. Since the company was founded in 1934, Armstrong has served customers with innovative product designs, excellent manufacturing quality and a singular focus on exceptional service. Genuine Armstrong Replacement Parts are manufactured with the highest quality materials, and provide you with an assurance of durability and compatibility. Armstrong replacement parts are designed for easy installation and long service life, continuing our long-standing tradition of excellence.

Maintenance Free-Ball Bearing SBA Series 2-5

The Armstrong ball bearing sba contain an interchangeable module that includes a stainless steel pump shaft and a housing that contains precision crafted front and back end bearings that are permanently lubricated. These 4 bearings replace more than 100 different Armstrong inline pump models (s&h/1050) can be converted to completely maintenance free pump during replacement or repair. Therefore, extensive and costly part inventories can be avoided easily. *This is a sleeve bearing rather than ball with a stainless steel faceplate making a suitable replacement for seal bearing assemblies in both standard bronze-fitted and all-bronze/lead free bronze construction circulators.



Part #	Model	B&G Cross
810119MF-001	S-25	118844/189134
810119MF-003	S-35	189166
816027MF-002	S-45,S-46 & H-41	189105
816032MF-000	S-55,S-57,H-51 H-52,H-53 & H-54	186863
816023MF-001	S-35	189120-29/189131
816999MF-041	Repl. ball bearing module only for above	
816366-041*	S-69, H63-H68	No equivalent

Resilient Mounted Motor Assembly



- Resilient mounting for long life and quiet operation
- Permanently lubricated design requires minimal maintenance
- Easily interchangeable with competing models
- 60 cycle, 1750RPM



Single Phase

Part #	HP	Volt/Rotation	Model	B&G Cross
805316-010	1/12	115V/CCW	S-25	111034
817025-005	1/6	115/CCW	N/A	111061
817025-001	1/6	115/CCW	S-34,S-35,H-32,H-41	111031/111036
817025-007	1/4	115/CCW	S-45	111040
817025-013	1/3	115/CCW	S-46	111042
816141-001	1/4	115/CW	H-51	169035
816141-002	1/3	115-230/CW	H-52	169038

Three Phase

831011-083	1/2	208/230/460	H-53,H-63,S-55	111046
816676-069	1	208/230/460	H-65,H-67,S-69	169233
816678-069	1-1/2	208/230/460	H-68	111052/169091/92
811757-004	1/2	575	H-54,H-63,S-57	
811757-006	3/4	575	H-54,H-64,S-57	



4 Spring Couplers

- Easy cross reference to competing models
- Cast iron construction for long service life with no rusting
- Replacement motor mounting rings are available to reduce coupler failures on resilient mounted motors
- 1/2" x 1/2"



Part#	Fits Model	B&G Cross
806026-001	S-25,S-34,S-35,H-32 & H-41	118705
806168-001	S-45 & S-46	118723

Body Gaskets



Part #	Model	B&G Cross
805176-000	S-25	P04080
106049-000	S-34,S-35,H-32	P04890
106050-000	S-45,S-46,H-41	P05800
106158-000	S-55,S-57,H-51 to H-54	P57410
106592-000	S-69,H-63 to H-68	P57700



Seal Kits

Part#	Size	Model	B&G Cross
816706-021	1/2"	S-25 to S-35,S-46,H-32 to H-41,S-55 to S-57, H-51 to H-54 & 1050's	118681
816707-001	3/4"	S-69, H63 to H-68	N/A



NEW Appliance Repair Videos

We have added hundreds of **Do-It-Yourself appliance repair videos** to the AMRE website!



Impellers - Universal

- NFI – Noryl (Plastic) Use on Potable and Non Potable
- Injection molding manufacturing process ensures a dimensionally perfect impeller
- Easy to trim, no balancing required
- Lightweight unit means reduced axial loading on the shaft



Part #	Dia.	Model	B&G Cross
816322-111	3-3/8"	S-35	118668
816305-328	3-7/8"	S-45	118676/118440
816305-325	4-1/4"	S-46	118675/118439
816304-321	4-3/4"	S-55	118630/118627
816304-317	5-1/4"	S-57	118629/118626
816301-325	4-1/4"	H-41	118830/118612
816302-319	5-1/4"	H-51	186441/186359/186360
816302-317	5-1/4"	H-52	186441/186259
816303-317	5-1/4"	H-53	186368/P61010



Valves / Regulators

Now Lead Free!

Threaded Union Inlet X Threaded Outlet

NPT Union inlet x female outlet. Max. Temperature: 160°F

Standard Cap. Bronze Water Pressure Regulator

(For potable water residential/commercial applications)

Standard Capacity - with bypass check valve & strainer

Standard Pressure - Range 25-75 PSIG - Max 300 PSIG

Without Gauge Tapping

PART#	DIMENSIONS	DIMENSIONS			
		A	B	C	D
0009217 (25AUB-1/2)	5 1/2" 1 1/4" 3 7/8" 2 1/2"	5 1/2"	1 1/4"	3 7/8"	2 1/2"
0009257 (25AUB-3/4)	5 1/2" 1 1/4" 3 7/8" 2 1/2"	5 1/2"	1 1/4"	3 7/8"	2 1/2"

With Gauge Tapping

PART#	DIMENSIONS	DIMENSIONS			
		A	B	C	D
0009234 (25AUB-G-1/2)	5 1/2" 1 1/4" 3 7/8" 2 1/2"	5 1/2"	1 1/4"	3 7/8"	2 1/2"
0009278 (25AUB-G-3/4)	5 1/2" 1 1/4" 3 7/8" 2 1/2"	5 1/2"	1 1/4"	3 7/8"	2 1/2"



SRV Valves

BRONZE

See our website www.amresupply.com for specs!

174A 3/4", 1", 1-1/4", 1-1/2"

Bronze standard capacity hot water boiler, pressure 30 - 150 PSI. A.S.M.E. Rated Pressure Safety Relief Valves For Hot Water Boilers.

Series 174A - for Hot Water Supply Boilers

PART#	SIZE	lbs/BTU
0274431 (174A-3/4-30)	3/4"	30/650,000
0274435 (174A-3/4-50)	3/4"	50/950,000
0274444 (174A-3/4-100)	3/4"	100/1,695,000
0274446 (174A-3/4-125)	3/4"	125/2,070,000
0274447 (174A-3/4-150)	3/4"	150/2,445,000
0274840 (174A-1-30)	1"	30/1,005,000
0274844 (174A-1-50)	1"	50/3,215,000
0274849 (174A-1-75)	1"	75/2,055,000
0274855 (174A-1-125)	1"	125/3,215,000
0274857 (174A-1-150)	1"	150/3,795,000



High Performance Water Pressure Regulator

Iron - Water Pressure Reducing Valves

Series U5B sizes 1/2" to 2" has built-in thermal expansion by-pass feature. Max. Temperature: 160°F

Initial Pressure: Up to 300 lbs. Adj. Reduced Pressure Range Valve set at 50 lbs. no flow pressure unless otherwise specified. Adj. from 25 to 75 lbs.



Now Lead Free!

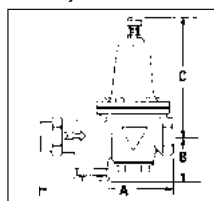

Safety Valves

CAST IRON



3/4", 1 1/4", 1 1/2" Cast iron - High capacity hot water boiler pressure 30 - 75 PSI. A wide range of relieving capacities. Lower BTU per thousand cost because this series provides a much higher BTU rating, size for size.

PART#	SIZE	lbs/BTU
0382330 (740-34-1-30)	3/4" X 1"	30/925,000
0382334 (740-34-1-50)	3/4" X 1"	50/1,352,000
0382540 (740-1-114-30)	1" X 1-1/4"	30/1,300,000
0383500 (740-112-30)	1-1/2" X 2"	30/2,900,000



For Non-Potable Water Systems (i.e. heating)

High Capacity - with bypass check valve & strainer

Standard Pressure - Range 25-75 PSIG - Max 300 PSIG

PART#	SIZE	INLET	DIMENSIONS		
			A	B	C
0009100 (U5B-1/2)	1/2"	Union	5-3/4"	1-7/8"	5"
0009118 (U5B-3/4)	3/4"	Union	6-3/8"	1-7/8"	5-3/8"

High Capacity - with bypass check valve & strainer

Low Pressure - Range 10-35 PSIG - Max 300 PSIG

PART#	SIZE	INLET	DIMENSIONS		
			A	B	C
0059844 (U5BLP-1/2)	1/2"	Union	5-3/4"	1-7/8"	5"
0009128 (U5BLP-3/4)	3/4"	Union	6-3/8"	1-7/8"	5-3/8"



Feed Water Pressure Regulator

For Hot Water Boilers

Iron - 5-5/16" Height

Watts 1156F. Max. Temperature 212°F, Max. Pressure 100 psi and Adjustment Range 10 - 25 lbs. Set at 15 psi.

PART#	SIZE	INLET	LEN
0386425 (1156F)	1/2"	Threaded	3-1/2"



Pressure Relief Valves



1L-2/125
10L-2/125
100XL-4/150



40XL-4/150
40XL-5/150



SL100XL3M7



10L, 100XL

Self-Closing Combination T.& P. Relief Valves Design Certified by A.G.A., A.S.M.E. Rated and C.G.A. Listed provides fully automatic temperature & pressure relief protection for hot water storage tanks & heaters up to 100,000 BTU/HR.

1L, 1XL - Size 1/2" (A.G.A., C.G.A.) Similar to series 100 except 1/2" valves do not comply with A.S.M.E. req.

40XL

For gas, electrical or oil-fired storage water heaters between 180,000 to 200,000 BTU/HR. Bronze body construction, vacuum relief valve vent in drain.

PART#	SIZE	THERMO LEN. (w/o THERM.)	A.G.A. TEMP Below Inlet Thr. RATING	MODEL STEAM
PSI/TEMP 125/210				
0004610 (1L-2/125)	1/2"	2"	15,000	M7
0004624 (10L-2/125)	3/4"	2"	80,000	M7
PSI/TEMP 150/210				
0066166 (100XL-4/150)	3/4"	4"	100,000	M7
0163782 (40XL-4/150)	1" M X 3/4" F	4"	500,000	M12
0158776 (40XL-5/150)	3/4" M X 3/4" F	5"	200,000	M12

Series 009 Backflow Reduced Pressure Zone Backflow Preventers



REPAIR KITS AVAILABLE



Features 2 in-line, independent check valves with an intermediate relief valve.

Max. Temperature: 33° - 180°F
Max. Pressure: 175 psi

PART# DIMENSIONS

0062094 (009-QT-1/2) 1/2"
0063030 (009M3-QT) 3/4"

Backflow Preventer Intermediate Atmospheric Vent. Dual Check Valve Type with atmospheric port



Series 9D Backflow Preventer Intermediate Atmospheric Vent, for use on hot or cold water and can be used under continuous pressure.
Max. Temperature: 250°F
Max. Pressure: 175 psi



PART# DIMENSIONS

0062025 (9D-1/2) 1/2"
0062026 (9D-3/4) 3/4"



1108-904 Brass
0063055 Chrome
Vacuum Breaker, Hose Connection type
3/4" F X 3/4" M



Its simple, clean heating systems perform better which means lower heating costs!

Boiler Maintenance FERNOX

F4-EXPRESS 265ml
Aerosol Boiler Leak Sealer



DS-40 2 kg
Descaler and Sludge Remover

GLYCOL

ProTek™ PG PLUS Propylene Glycol
Each concentration **must** be further diluted to alter freeze and burst temperatures. Refer to the technical data sheet for specific information. Suitable for potable water systems.

F1-EXPRESS 265ml
Aerosol Lime/Scale

F1-PROTECTOR 500ml
Lime/Scale

F5-EXPRESS 280ml
Aerosol Heating Sys. Cleaner

F3-CLEANER 500ml
Heating Sys. Cleaner

F1-COMKIT
Boiler Commissioning kit
1 x F1 Protector, 1 x F3 Cleaner, 4 PH test strips, (2) 60 sec. protector test strips

F2-EXPRESS 265ml
Aerosol Noise Silencer

F2-SILENCER 500ml
Noise Silencer

ALPHI-1130
30%, -15°C

ALPHI-1150
50%, -34°C
Antifreeze protector, combination antifreeze and inhibitor to protect corrosion and lime scale formation

New!

55586
Refractometer, antifreeze tester



Part WATER/GLYCOL (RATIO = 95/5)
ProTek-Plus™
PG-PLUS 1 Gallon Jug
PG-PLUS-5 5 Gallon Pail
PG-PLUS-55 55 Gallon Drum

Hydroniclean System



H-10 Hi-Temp Plastic Complete Unit
RHB-997 Stainless Steel Complete Unit
Complete side stream filtering system
An engineered system for removing suspended solids from heating water, glycol, brine and other closed recirculating hydronic systems.

- H-10 Parts**
- HPB-70-FI** Flow indicators
 - HPB-70-FB** Flow indicator ball
 - HPB-70-IG** EPDM 1/8" inner gasket
 - HPB-70-OG** 1/16" outer gasket
 - HPB-70-RL** Tempered glass lens
 - HPB-70-SOCKET** Tightening socket
 - H-10-HOUSING** Housing only
 - H-10-CAP** Replacement cap
 - H-10-O-RING** Silicone "O"-ring
 - H-10-WRENCH** Canister wrench

- RHB Parts**
- RHB-329** Housing "O"-ring
 - RHB-330** Housing "O"-ring
 - RHB-118** Tightening rod
 - RHB-137** Housing pet cock drain valve
 - RHB-DRAIN** Petcock

Clean Water In Your Boilers Improves Energy Consumption Guaranteed!

Filters



PART MICRONS

- CU5R97T** 5
- CU10R97T** 10
- CU20R97T** 20
- CU25R97T** 25
- CU30R97T** 30
- CU50R97T** 50

Standard Boiler Filters
Unbleached Cotton, string wound, economy
9-7/8 x 2-1/2"



We carry repair parts for all Watts backflow valves Call us with Model# and Parts required!



Pressure Gauges

Pressure Gauges, Dry

Part#	Size	Mount/Size	Range
PEM212	2.5"	Bottom 1/4" MPT	0-30psi
PEM213	2.5"	Bottom 1/4" MPT	0-60psi
PEM214	2.5"	Bottom 1/4" MPT	0-100psi
PEM215	2.5"	Bottom 1/4" MPT	0-160psi
PEM216	2.5"	Bottom 1/4" MPT	0-200psi
PEM217	2.5"	Bottom 1/4" MPT	0-300psi
PEM221	4"	Bottom 1/4" MPT	0-30psi
PEM222	4"	Bottom 1/4" MPT	0-60psi
PEM223	4"	Bottom 1/4" MPT	0-100psi
PEM224	4"	Bottom 1/4" MPT	0-160psi
PEM225	4"	Bottom 1/4" MPT	0-200psi

Pressure Gauges, Wet (Liquid Filled resists vibrations better than dry)

Part#	Size	Mount/Size	Range
PFQ802	2.5"	Bottom 1/4" MPT	0-30psi
PFQ803	2.5"	Bottom 1/4" MPT	0-60psi
PFQ804	2.5"	Bottom 1/4" MPT	0-100psi
PFQ806	2.5"	Bottom 1/4" MPT	0-200psi
PFQ812	2.5"	Bottom 1/4" MPT	0-5000psi
PCT322	4.5"	Bottom 1/4" MPT	0-60psi
PCT323	4.5"	Bottom 1/4" MPT	0-100psi
PCT324	4.5"	Bottom 1/4" MPT	0-160psi

All purpose pressure gauge. 5 yr. warranty. Applications: Plumbing, heating, a/c, pneumatic, hydraulic, water tanks, air compressors, OEM



Visit amresupply.com for full selection of in-stock gauges, 100's more to choose from

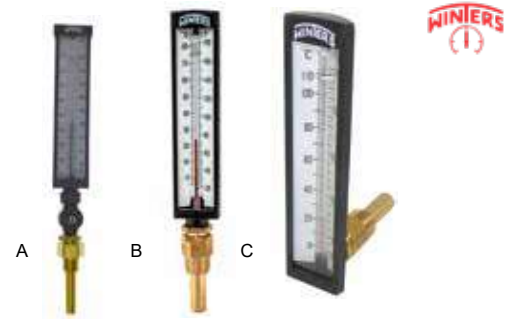

Hot Water Angle Thermometers 3.5" Stems

Part#	Size	Mount/Size	Range	Fig.
TIM103	9"	Bottom/Angle 3/4"	0-160F/-15-70C	A
TIM100	9"	Bottom/Angle 3/4"	30-240F/0-115	A
TIM105	9"	Bottom/Angle 3/4"	30-300F/0-150C	A

Hot Water Straight Thermometers, 2" stem

Part#	Size	Mount/Size	Range	Fig.
TAS131	5"	Bottom 1/2"	20-180F/-5-80C	B
TAS132	5"	Bottom 1/2"	30-240F/0-115C	B

Hot Water Angle Thermometers, 2" stem

Part#	Size	Mount/Size	Range	Fig.
TAS141	5"	Back 1/2"	20-180F/-5-80C	C
TAS150	5"	Back 1/2"	30-240F/0-115C	C

Pressure Gauges - Digital

Other sizes available

Part#	Size	Mount/Size	Range
DPG210	2.5"	Bottom 1/4" MPT	0-15psi
DPG211	2.5"	Bottom 1/4" MPT	0-15psi
DPG212	2.5"	Bottom 1/4" MPT	0-30psi
DPG214	2.5"	Bottom 1/4" MPT	0-100psi

Digital Pressure Gauge. Simple 2 button operation, Re-zero feature and peak pressure reading, Backlight turns on when on/off button is pressed and with pressure changes, 316L welded diaphragm seal, Rubber boot is standard, 2xAAA battery



Digital Gauges

These gauges are self powered and are within 1% degree accuracy. There is no unfriendly liquids or components to the environment meeting many building codes or facility requirements. 3/8" LCD digits make this thermometer easy to read and with the vari-angle mount, installation in most environments is a snap.

Part#	Size	Mount/Size	Range
TSD9ITSD	4.5	Angle/Bottom	-50-320F/-45-160C



Tri-O-Meters (Hot Water)



Reads Water Pressure, Water Temperature and Head pressure

Part#	Size	Mount/Size	Range	Temp	Fig.
TTD401	2.5"	Rear 1/4" NPT	0-75psi-ft/lbs	70-320F/20-160C	A
TTD404	2.5"	Rear 1/4" NPT	0-75psi-ft/lbs	70-320F/20-160C	A
TTD402	3"	Rear 1/2" NPT	0-75psi-ft/lbs	70-320F/20-160C	A
TTD403	3"	Lower 1/2" NPT	0-75psi-ft/lbs	70-320F/20-160C	B
TTD407	3"	Rear 1/2" NPT	0-200psi-ft/lbs	70-320F/20-160C	A
TTD405	3"	Lower 1/2" NPT	0-200psi-ft/lbs	70-320F/20-160C	B

Economy Thermometer - Straight & Angled

Hot Water Angle Thermometer

Part#	Size	Mount/Size	Range
TSW173	8"	Bottom/Angle 1/2" MPT	40-280F/5-135C

Hot Water Straight Thermometer

Part#	Size	Mount/Size	Range
TSW172	8"	Bottom/Straight 1/2" MPT	40-280F/5-135C

Hot Water Round Thermometer 2" Stem

Part#	Size	Mount/Size	Range
TSW174	2.5"	Rear 1/2" NPT	30-250F/0-120C

Wells available separately



Aqua Stats

Honeywell

IMMERSION TYPE CONTROLLERS FOR LIMITING OR REGULATING TEMPERATURES OF LIQUIDS IN BOILERS OR TANKS.

Sensing element actuates enclosed Micro Switch snap acting switch. TRADELINE models include well adapter and tube of heat-conductive compound. Horizontal or vertical mounting available. Bulb: Copper, 9.5 X 73.0 mm (3/8" X 2 7/8"). Listed by Underwriters Laboratories Inc; certified by CSA; certified by American Gas Association -L4006A.

Part#	App.	Range	Includes
L4006A1009	High or Low Limit	38-116 C	38.1 mm (1-1/2") insulation immersion well
L4006A1678	High or Low Limit	38-116 C	73 mm (2-7/8") sensing bulb stop factory set at 116 C (240 F) less immersion well
L4006A1959	High or Low Limit	4-82 C	73 mm (2-7/8") sensing bulb, with well adapter, heat -cond. compound horizontal or vertical mount
L6006A1145	Circulator & High or Low Limit	38-116 C	72 mm (2-7/8") insulation, stop factory set at 116 C (240 F). With well adapter, heat cond. compound Horizontal or vertical mount.

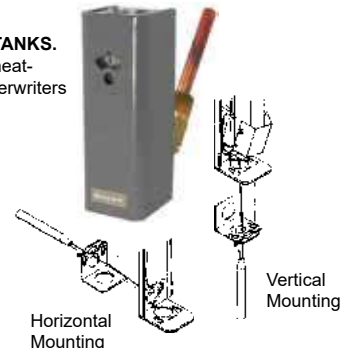

Hydronic Heating

Used with zone valves, normally open or normally closed. These thermostats are 24V and must match valve operation.



Part#	Brand	Fig.	Scale	Voltage	Colour	Valve Operated
T822K1034	Honeywell	A	10-30C	24V	White	Normally Closed
T822L1000	Honeywell	A	10-30C	24V	White	Normally Open
1E30N-311	White Rodgers	B	10-30C	24V	White	Normally Closed
1E56N-361	White Rodgers	B	10-30C	24V	White	Normally Open
1F56N-361	White Rodgers	D	10-30C	24V	White	Normally Open/Closed
RAA20UW*	Siemens	C	10-30C	24V	White	Normally Open/Closed

*The RAA20UW is designed to be used with either normally open or normally closed valves. It has both make on rise & break on rise circuits.

Braeburn.

Economical upgrade option



- 1000NC** 1H/1C Non-Programmable
 - 2000NC** 1H/1C 5-2 Programmable
- Braeburn Value Series Thermostats
- For use with single stage conventional, heat pump, 2 wire hydronic and millivolt systems
 - 3.72"H x 4.75"W, hardwire or battery, 2x AA included
 - Adjustable temp limits, 2000 series has filter monitor

White Rodgers.



Horizontal
not exactly as shown

Vertical
not exactly as shown

Vertical

- 1E78-140** Heat Only Non-programmable
- 1E78-144** 1H/1C Non-programmable
- 1E78-151** 1H/1C Programmable 5-2 Day

Horizontal

- 1F78-144** 1H/1C Non-programmable
 - 1F78-151** 1H/1C Programmable 5-2 Day
- White-Rodgers Digital Thermostats
- Single stage, domestic, heat pump (144/151 only) and millivolt systems.
 - Heat/Cool/Off, Fan Auto-Off
 - 3-3/16"W x 5-5/16"H (Vert) 3-13/16"H x 5-1/8"W (Horz)
 - Backlit display, electronic temperature accuracy

White Rodgers.



- 1F80-0261** White Rodgers 5-1-1 Programmable Digital Thermostat. Heat/Cool. 24V or millivolt, lighted digital display, dual power battery/wired



Horizontal



Vertical

Honeywell

- TH2110DH1002** 1Heat/1Cool Horizontal
 - TH2110DV1008** 1Heat/1Cool Vertical
- Honeywell PRO2000 Programmable Thermostat
- Easy to use/program
 - 5-2 Day programming, 20-30Vac or 750mV
 - 4-11/16"H x 2-7/8"W (1008) 3-7/16"H x 4-5/8"W (1002)

Forced Air

Most common single stage for heating only applications. These thermostats are 24V, low voltage, and come in both vertical & horizontal mounting configurations. All models have adjustable heat anticipators.

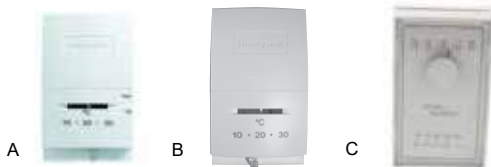

Part#	Brand	Fig.	Scale	Voltage	Colour	Mounting
T822K1026	Honeywell	A	10-30C	24V	White	Vertical
T827K1017	Honeywell	A	10-30C	750mv	White	Vertical
T822K1034	Honeywell	B	10-30C	24V	White	Vertical
1E30N-311	White Rodgers	C	10-32C	24V	White	Vertical

Electric Heat

Commonly used with electric baseboards or wall insert electric heaters or electric furnaces. These thermostats are single stage, line voltage. Single stage thermostats, line voltage

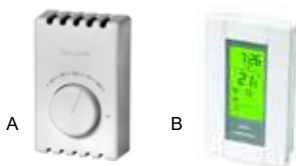

See page 247 for baseboard mount thermostats

Part#	Brand	Fig.	Scale	Poles	Colour	Voltage
T410A1021	Honeywell	A	5-25C	SPST	White	120V/240V
TH115-A-120S*	Honeywell	B	0-50C	SPST	White	120V
TL8130A1005*	Honeywell	B	0-50C	SPST	White	208/240V

*7 day programmable, advanced control minimizes temperature swings

Honeywell



Horizontal

Vertical

- TH1100DV1000** 1 Heat Only Vertical
 - TH1110DV1009** 1H/1C Vertical
 - TH1100DH1004** 1 Heat Only Horizontal
- Honeywell PRO1000 Non-programmable Thermostat
- Simple temperature control
 - 4-11/16"H x 2-7/8"W (Vert) 3-7/16"H x 4-5/8"W (Horz)
 - 20-30Vac or 750mV



Honeywell



Part #	Function	Fig	Application
TH3110D1008	Non-Programmable	A	1Heat/1Cool
TH3210D1004	Non-Programmable	B	2Heat/1Cool
TH4110D1007	5-2 Day Program	C	1Heat/1Cool
TH5110D1006	Non Programmable	D	1Heat/1Cool
TH5110D1022	Non Program (Large Display)	D	1Heat/1Cool
TH5220D1029	Non Programmable	E	2Heat/2Cool
TH8320R1003	7 Day Program	F	3Heat/2Cool
TH8110R1008	7 Day Program	F	1Heat/1Cool
TH8321WF1001	7 Day Program	F	3Heat/2Cool WIFI

Honeywell Digital Thermostats. See website for specs. Most models will operate conventional heat and heat pump applications. 5-32C temperature setting range, Operates 20-30VAC and 750mV voltages. White finish.

Honeywell



TH4110U2005 1H/1C Heat Pump, 1H/1C Conventional
Honeywell T4Pro Series Programmable Thermostat
- 7 Day scheduling, 3.93" display
- Auto heat cool to maintain comfort
- Easy to use/program

Honeywell



TH6220U2000 2H/1C Heat Pump, 2H/2C
TH6210U2001 2H/1C Heat Pump, 1H/1C
TH6320U2008 3H/2C Heat Pump, 2H/2C
Conventional Honeywell T6Pro Series Programmable Thermostats
- 7 Day scheduling, 5.44" display
- Auto heat or cool to maintain comfort
- Easy to use/program
- Dual fuel capability on TH6320 & TH6220

Honeywell



TH6220WF2006 2H/1C Heat Pump, 2H/2C
TH6320WF2003 3H/2C Heat Pump, 2H/2C
Conventional Honeywell Lyric T6Pro Wi-Fi Series
- Programmable Thermostats.
- Easy control with Lyric App, 7 day programming
- Dual fuel capability on TH6320, auto heat/cool
- Geofencing option, touch screen
- Easy to use/program and install

Honeywell

Compatible with PTAC units
& Fan Coils



TB7100A1000
Honeywell MultiPRO Thermostat
- Multispeed, multipurpose, programmable or non-programmable
- 1 Heat/ 1Cool Conventional; Up to 2 Heat/ 1 Cool Heat Pump; 2 or 4 pipe Fan Coil;
Up to 2 Heat/ 1 Cool PTAC
- Up to 3 fan speeds for fan coils, 2 for PTAC
- 24Vac or Battery

Enhanced Features and New Design!

Simple installation.
Just load the app and follow the video step by step!

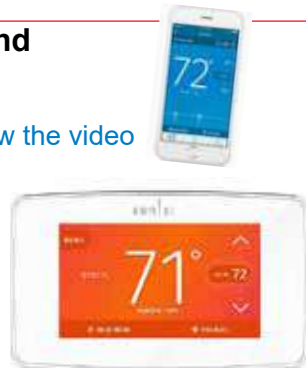

1F95U-42WFC

Sensi Touch Screen WiFi Thermostat.

Features:

- Heat/Cool/Auto/Off modes
- Full 7 day programmable
- Smart alerts, geofencing options
- Humidity readings, back glow, color shift
- 2 stage Heat/Cool
- Top Rated App for Apple and Android

Accessories also available sold separate:

- SA11** C-wire kit
F61-2689 Oversized wall plate for 1F95U 6-3/4" x 4-1/2"

White Rodgers. **sensi**

1F87U-42WFC

Sensi WiFi Thermostat.

Features:

- Heat/Cool/Off modes
- Full 7 day programmable
- Smart alerts, geofencing options
- Humidity readings, backlight
- 2 stage Heat/Cool
- Top Rated App for Apple and Android

Accessories also available sold separate:

- SA11** C-wire kit
F61-2663 Oversized wall plate for 1F87U 6-3/4" x 4-1/2"



Full selection of Thermostats!
Residential to Commercial we have you covered!

www.amresupply.com/HVAC > Wall Thermostats >





Plastic				
PART#	BASE	INSIDE DIAMETER (in.)		
		L	W	D
77-PG3	RING	3.75	3.50	2.62
	SOLID	4.00	4.00	2.50
585-TG2	RING	5.25	4.62	3.12
	SOLID	5.75	5.00	2.81
585-TG6	RING	6.31	3.62	3.06
	SOLID	6.62	4.12	2.75
77-PG12	RING	8.18	4.62	3.56
	SOLID	8.50	5.00	3.87

Thermostat Guards Hi-impact Plastic

- . Durable Metal
- . Horizontal or Vertical Mounting
- . Comes with complete mounting hardware
- . With Ring & Solid Base
- . Color: Clear Cover Off White Base



Metal				
PART#	BASE	INSIDE DIAMETER (in.)		
		L	W	D
77-MG3	RING	5.31	4.31	3.00
	SOLID	5.62	5.12	2.87
77-MG6	RING	6.31	3.62	3.18
	SOLID	6.62	4.12	3.75
77-MG9	RING	6.75	4.50	3.43
	SOLID	7.18	5.25	3.43
77-MG12R	RING	6.12	3.81	3.12

Thermostat Guards Metal

- . Durable Metal
- . Horizontal or Vertical Mounting
- . Comes with complete mounting hardware
- . With Ring & Solid Base
- . Color: Off White



* Metal guards are hinged

UniMatch® cogged raw edge multiple V-belts Oil and heat resistant. Static dissipating. RMA spec multiple V-belts in a raw edge, cogged construction are especially useful for high speed, compact drives. These belts all have the UniMatch feature. Raw edge, cogged multiple V-belts are listed by industry number in which the first letter indicates belt section, the X is a cogged construction and the number is belt **inside length** in inches.

Popular - AX

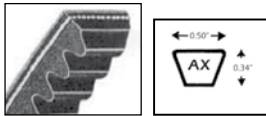

- | | | | |
|------|-----|------|-----|
| AX35 | 37" | AX49 | 51" |
| AX36 | 38" | AX50 | 52" |
| AX37 | 39" | AX51 | 53" |
| AX38 | 40" | AX52 | 54" |
| AX39 | 41" | AX53 | 55" |
| AX40 | 42" | AX54 | 56" |
| AX41 | 43" | AX55 | 57" |
| AX42 | 44" | AX56 | 58" |
| AX43 | 45" | AX57 | 59" |
| AX44 | 46" | AX58 | 60" |
| AX45 | 47" | AX59 | 61" |
| AX46 | 48" | AX60 | 62" |
| AX47 | 49" | AX61 | 63" |
| AX48 | 50" | AX62 | 64" |

We stock AX21 - AX96 Belts



A00607 311g

Belt Dressing conditions belts while increasing pulling power up to 50%. Reduces squeaky noise. Can be applied directly to belts & sheaves of "V" belts while running. Uses: Leather, rubber, canvas, fabric; flat, round or "V" belts, auto fan belts, farm machinery belting; all industrial belt drives including generators and fans

Popular - B

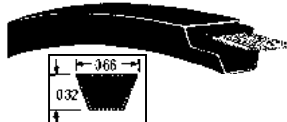

- | | | | |
|-----|-----|-----|-----|
| B30 | 33" | B54 | 57" |
| B31 | 34" | B55 | 58" |
| B32 | 35" | B56 | 59" |
| B33 | 36" | B57 | 60" |
| B34 | 37" | B58 | 61" |
| B35 | 38" | B59 | 62" |
| B36 | 39" | B60 | 63" |
| B37 | 40" | B61 | 64" |
| B38 | 41" | B62 | 65" |
| B39 | 42" | B63 | 66" |
| B40 | 43" | B64 | 67" |
| B41 | 44" | B65 | 68" |
| B42 | 45" | B66 | 69" |
| B43 | 46" | B67 | 70" |
| B44 | 47" | B68 | 71" |
| B45 | 48" | B69 | 72" |
| B46 | 49" | B70 | 73" |
| B47 | 50" | B71 | 74" |
| B48 | 51" | B72 | 75" |
| B49 | 52" | B74 | 77" |
| B50 | 53" | B75 | 78" |
| B51 | 54" | B77 | 80" |
| B52 | 55" | B78 | 81" |
| B53 | 56" | B79 | 82" |

We stock B21 - B315 Belts



Popular - BX

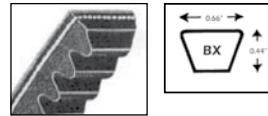

- | | | | |
|------|-----|------|-----|
| BX30 | 33" | BX56 | 59" |
| BX31 | 34" | BX57 | 60" |
| BX32 | 35" | BX58 | 61" |
| BX33 | 36" | BX59 | 62" |
| BX34 | 37" | BX60 | 63" |
| BX35 | 38" | BX61 | 64" |
| BX36 | 39" | BX62 | 65" |
| BX37 | 40" | BX63 | 66" |
| BX38 | 41" | BX64 | 67" |
| BX39 | 42" | BX65 | 68" |
| BX40 | 43" | BX66 | 69" |
| BX41 | 44" | BX67 | 70" |
| BX42 | 45" | BX68 | 71" |
| BX43 | 46" | BX69 | 72" |
| BX44 | 47" | BX70 | 73" |
| BX45 | 48" | BX71 | 74" |
| BX46 | 49" | BX72 | 75" |
| BX47 | 50" | BX73 | 76" |
| BX48 | 51" | BX74 | 77" |
| BX49 | 52" | BX75 | 78" |
| BX50 | 53" | BX76 | 79" |
| BX51 | 54" | BX77 | 80" |
| BX52 | 55" | BX78 | 81" |
| BX53 | 56" | BX79 | 82" |
| BX54 | 57" | BX80 | 83" |
| BX55 | 58" | | |

We stock BX27 - BX162 Belts

Popular - 4L (A)



- | | |
|-------------|------|
| PART # | DIA. |
| 4L350 (A33) | 35" |
| 4L360 (A34) | 36" |
| 4L370 (A35) | 37" |
| 4L380 (A36) | 38" |
| 4L390 (A37) | 39" |
| 4L400 (A38) | 40" |
| 4L410 (A39) | 41" |
| 4L420 (A40) | 42" |
| 4L430 (A41) | 43" |
| 4L440 (A42) | 44" |
| 4L450 (A43) | 45" |
| 4L460 (A44) | 46" |
| 4L470 (A45) | 47" |
| 4L480 (A46) | 48" |
| 4L490 (A47) | 49" |
| 4L500 (A48) | 50" |
| 4L510 (A49) | 51" |
| 4L520 (A50) | 52" |
| 4L530 (A51) | 53" |
| 4L540 (A52) | 54" |
| 4L550 (A53) | 55" |
| 4L560 (A54) | 56" |
| 4L570 (A55) | 57" |
| 4L580 (A56) | 58" |
| 4L590 (A57) | 59" |

Check Web for MORE sizes!

We stock 4L170 - 4L1000 Belts

Best Sellers



POLYESTER

Series PD/PT Polyester Media



Series PD/PT Polyester Media is effective in light and moderate dirt environments.

PADS

Polyester 1/2"			
Size	Dry		
10" X 10"	1006282		
Polyester 1"			
Size	Dry	Tackified	
16" X 20"	18659		
16" X 25"	18660	18666	
20" X 20"	18661	18667	
20" X 25"	18662	18668	
24" X 24"	18663		
Polyester 2"			
Size	Dry	Tackified	
12" X 24"	18670	18676	
16" X 20"	18671	18677	
16" X 25"	18672	18678	
20" X 20"	18673	18679	
20" X 25"	18674	18680	
24" X 24"	18675	18681	

ROLLS

Polyester 1" Bulk Rolls, 120ft.		
Width	Dry	Tackified
20"	18686	18695
25"	18687	18696
30"	18688	
36"	18689	
Polyester 2" Bulk Rolls, 75ft.		
Width	Dry	Tackified
20"	18702	18709
25"	18703	18710



AMRE is proud to supply Greentek HRV replacement parts in stock!

Contact us today with your model number 1-800-661-9891

Series DDP 3-Ply (15/40) Polyester Ring Panel Filters Galvanized Wire Frame



The Aerostar 3-Ply (15/40) Polyester Ring Panel filters incorporate three distinct filter layers permanently heat-sealed around the edges.

Size	Coated
16" X 20"	10865
24" X 24"	10877



Poly Strand Throwaway Filter
Glass fibres are encapsulated in a polyester coating to maximize particulate retention. Designed for use in residential, retail, commercial and industrial applications. UL 900 Class 2

HAMMOCK FILTERS

Polyester filter medias are used for all applications including residential, commercial and institutional HVAC system, unit ventilators, fan coils PTAC, electrical cabinets and motor cabinets for protection from accumulation of dust and dirt.

PART #	SIZE
FUR2025	20" X 25"
1004536	30" X 32"
1000311	30" X 45"
1004081	30" X 62"

Hammock Style Filter, 1 per pkg.



Poly Strand Throwaway Filter

PART # 1"	Part# 2"	SIZE
10002	10043	10" X 20"
51888		11" X 20"
10017		12" X 12"
10004	10044	12" X 24"
30009		14" X 16"
10006	10045	14" X 20"
10007	10046	14" X 25"
	10047	15" X 20"
10019	10100	16" X 16"
10009	10048	16" X 20"
10027	10051	16" X 24"
10010F	10049	16" X 25"
10028		18" X 18"
10029	1016564	18" X 20"
10030	10052	18" X 24"
10031	1016063	18" X 25"
10011	10050	20" X 20"
10034F	10053	20" X 24"
10012	10054	20" X 25"
10040	1000529	20" X 30"
10038	10055	24" X 24"

Filter Facts

Filter Lifespan. Filters should be changed approx. every 2 months depending on equipment. Consult the instruction manual to insure you are protecting your equipment.

Good - Better - Best. For throwaway filters fiberglass has been a "good" economical choice for many years, but now we are seeing a "better" poly strand version as well as affordable "best" pleated filters that remove much more particles from the air

MERV measures a filter's arrestance — a filter's ability to remove large airborne particles from the air — and dust-spot efficiency — its ability to remove small airborne particles — and assigns a number based on the filter's ability to remove the particles. Several types of air filters are common in commercial HVAC systems.

Contact a sales representative for a quantity pricing quote, and take advantage of great savings!



FIBERGLASS

Series FGB Standard Grade

Series FGB Standard Grade coated media is recommended in light industrial and commercial systems that require lower resistance levels.

Standard Grade Coated Fiberglass - Media (Yellow)

Width	1"
16" X 20"	18530
16" X 25"	18531

Standard Grade Coated Fiberglass - Media (Yellow)

Width	2"
12" X 24"	18535
16" X 20"	18536
16" X 25"	18537
20" X 25"	18539
24" X 24"	18540



Pad Holding Frames

Give us a call with your pad size!



Permanent Pad Holding Frames are constructed of a durable 24 gauge galvanized steel frame. Pad and frame systems require no modification of existing hardware and allow for easy media pad replacements.

PLEATED



Series SC MERV 8

Series SC MERV 8 Standard Capacity Pleated Filters. **30-35%**

PART# 1"	PART# 2"	PART# 4"	SIZE
10364	10379	-	10" X 20"
10366	10419	-	12" X 20"
10367	10380	10393	12" X 24"
10369	10381	-	14" X 20"
10370	10382	-	14" X 25"
10371	10383	-	15" X 20"
10410	10420	-	16" X 16"
10372	10384	10394	16" X 20"
10411	10385	-	16" X 24"
10373	10386	10395	16" X 25"
10415	10387	-	18" X 24"
10375	10388	10397	20" X 20"
10416	10389	10398	20" X 24"
10376	10390	10399	20" X 25"
10377	10391	10400	24" X 24"
-	10392	-	25" X 25"

Disposable Pleated Air Filters, each



Series HC MERV 10



Series HC MERV 10 High Capacity Pleated Filters.

PART# 1"	Part# 2"	Part# 4"	SIZE
10436	-	-	10" X 20"
10438	-	-	12" X 20"
-	10452	-	12" X 24"
10441	-	-	14" X 20"
-	10454	-	14" X 25"
10443	10455	-	15" X 20"
-	10493	-	16" X 16"
10444	10456	10466	16" X 20"
10484	-	-	16" X 24"
10445	10458	10467	16" X 25"
-	10459	-	18" X 24"
10447	10460	-	20" X 20"
10489	10461	-	20" X 24"
10448	10462	10471	20" X 25"
10449	10463	-	24" X 24"

Disposable Pleated Air Filters, each



Part#	SIZE
1011116	15-3/4" x 24-3/4" x 4-3/8"
1019348	19-1/2" x 19-1/2" x 4-3/8"
1015871	19-3/4" x 24-7/8" x 4-3/8"
1011848	24-1/8" x 19-5/8" x 4-7/8"

Series HC1100 MERV 11



Series HC1100 MERV 11 High Capacity Pleated Filters. **60-65%**

Part# 2"	Part# 4"	Part# 5"	Size
19655	19667	1028440	16" x 20"
19657	19668	1027579	16" x 25"
19661	19670	-	20" x 20"
-	19672	1027580	20" x 25"
19664	-	-	24" x 24"



Series MERV 13



MERV 13 Green Pleat (LEED) Pleated Filters. **89-90%**

Part# 2"	Part# 3"	Part# 5"	Size
21519	-	-	16" x 20"
21521	1028446	-	16" x 25"
1033198	-	-	18" x 18"
21524	-	-	20" x 20"
21525	-	-	20" x 24"
21526	-	1028452	20" x 25"
21527	-	-	24" x 24"



Honeywell

Honeywell PopUP Media Filter, MERV 11

Part#	Sizes
POPUP1620	16 x 20 x 5 (16" x 19-3/4" x 4-1/2")
POPUP1625	16 x 25 x 5 (16" x 24-3/4" x 4-1/2")
POPUP2020	20 x 20 x 5 (20" x 19-3/4" x 4-1/2")
POPUP2025	20 x 25 x 5 (20" x 24-3/4" x 4-1/2")

Checkout our website for: Full selection of grilles, registers and diffusers

Ceiling Registers

Part #	Dimension
WG401	4"
WG501	5"
WG601	6"

Adjust-A-Vent

Adjustable air diffuser with extended base. Keeps your ceiling clean, air flows away from the mounting surface with this easy to install and remove, dual flow air supply and air exhaust diffuser. Stainless steel grip-clip, extra thick foam gasket. Snow White finish.



Floor Registers

3" X 10"	
White	HR310-01
Choc. Brown	HR310-06
Almond	HR310-03
Stormy Grey	HR310-05

4" X 10"	
White	HR410-01
Choc. Brown	HR410-06
Almond	HR410-03
Stormy Grey	HR410-05

2-1/4" x 12"	
White	HR212-01
Choc. Brown	HR212-06
Almond	HR212-03
Stormy Grey	HR212-05



Almond

Choc. Brown

White

Stormy Grey



Plastic Heat Floor Registers

High strength durable polymer resin, easy to clean, easy finger tip louver control.

3" x 10"	
White	RG0222
Almond	RG0219
Brown	RG0203
Pewter	RG1994

4" x 10"	
White	RG0246
Brown	RG0234
Pewter	RG1995

4" x 12"	
White	RG0267
Brown	RG0257
Pewter	RG1997

2-1/4" x 12"	
White	RG0179
Brown	RG0168
Pewter	RG1996

2-1/4" x 14"	
White	RG0198
Brown	RG0189



White

Brown

Pewter



Metal Heat Floor Registers

All-steel construction, widespread air diffusion, easy-to-operate damper control, rolled fin for strength and safety, painted with durable powder-coat finish



AD96ZW

Premium Air Register Deflector.

Helps keep air away from plants, furniture and drapery. Made from high quality, durable plastic and comes complete with 2 magnets. Adjustable from 8" - 14".



Return Air Grilles

Part #	Dimension
RG126-01	6" X 12"
RG146-01	6" X 14"
RG186-01	6" X 18"
RG206-01	6" X 20"
RG246-01	6" X 24"
RG306-01	6" X 30"

Plastic Standard 3/16" Return Air Grilles

Aesthetically-pleasing finish. Easy to install, easy to remove and clean. Durable Polymer resin. Dent, scratch, and heat distortion resistant. Snow White finish.



Part #	Dimension
RG0314	14" X 8"
RG0317	24" X 8"
RG0320	30" X 8"

Metal Cold Air 2" Projection Grills

All-steel construction, 1/3" fins set at 20° angle, 2" base extension, durable white powder-coat painted finish



Part #	Dimension
RG0553	6" X 6"
RG0564	8" X 6"
RG0351	10" X 6"
RG0385	12" X 6"

RG0358	10" X 8"
RG0392	12" X 8"
RG0428	14" X 8"
RG0455	16" X 8"
RG0522	24" X 8"
RG0550	30" X 8"



RG0432	16" X 10"
--------	-----------

Metal Standard 3/16" Flange Sidewall Grilles

One-piece all-steel construction, 1/3" spaced fins set at 20° angle, 3/16" margin turnback, painted white with durable powder-coat finish.



Part #	Dimension
RG0033	14" X 6"
RG0049	16" X 6"
RG0057	18" X 6"
RG0077	24" X 6"
RG0095	30" X 6"

RG0042	14" X 8"
RG0053	16" X 8"
RG0061	18" X 8"
RG0086	24" X 8"
RG0104	30" X 8"

Metal Standard 7/8" Return Air Grilles

One-piece all-steel construction, 1/3" spaced fins set at 20° angle, 7/8" margin turnback, painted white with durable powder-coat finish



Looking for commercial ceiling diffusers or grilles?

We can help. Call us today for your needs!



White
Rodgers



PAD-A04-1725-052
White Rodgers Skuttle Replacement Humidifier Pad approximately 11-1/2" x 9-3/4" x 1-3/4".

Lau
Industries



404368-02
Humidifier media pad 8" X 24" for VA-2

Lau
Industries



404073-02
Lau humidifier plates for L-40 (pkg. of 5)

Lau
Industries



404718-01
Lau humidifier valve button

Lau
Industries



404384-01
Lau humidifier media wheel

Lau
Industries



404606-01
Lau humidifier float assembly with valve
404701-01
Lau humidifier float only

GeneralAire



GF-990-53
General Aire Solenoid Water Valve. (24V, 3.5GPH)

GeneralAire



GF-109942
General Aire Solenoid Water Valve. (24V, 6GPH)

UHS24

Universal humidifier solenoid. Replaces over 32 OEM models. Fittings incl. 24V

Lau
Industries



431290-01
Lau humidifier water pan

Honeywell



HC22A1007
Honeywell Humidifier filter pad 9-1/2" x 10"

Honeywell



HC26A1008
Honeywell Humidifier filter panel 10" x 13"

Honeywell
HC22E1003
9-1/2" x 10"



HC26E1004
10" x 13"

Honeywell Humidifier Pad with AgION Coating

GeneralAire



990-13
GeneralAire Humidifier Pad with frame. Use with legacy models. 12" x 9-3/4"W x 1-1/2"D

GeneralAire



GF-81-15
GeneralAire Humidifier Evaporator Pad. 9"Dia x 7-1/2"W x 1/2"D

Lau
Industries

New!



GF-GA10
GeneralAire Humidifier Pad. 10"L x 9-1/2"W x 1-7/16"D

Lau
Industries

PRO PICK



H-40

Lau Evaporative Plate-Style Humidifier.

The simplest furnace-mounted humidifier to add some much needed moisture to the air of your home.

- Non-Powered
- Plates sold separately (404073-02)

Honeywell

HE200A1000
Honeywell TrueEASE Basic Evaporative Flow-Through Humidifier.

- 17 gal. per day
- Easy to install with quick snap bypass direction adjustment. Easy to replace pads.
- Versatile fit designed for more jobs.
- Fast installation for labor and time savings.
- Operational noise reduction for humidity comfort without the ear aches.
- Includes HumidiPRO Digital Humidity Control
- Capacity: 17 gal/day (64L/day)



Desert Spring
Products



DS-PFT

Desert Spring Pulsed Flow-Through Humidifier. 13 gal. per day
For those who prefer the convenience of disposable evaporative media. Saves up to 80% of the water

- The water supply solenoid valve is pulsed on for approximately 2-4 seconds, to soak the entire evaporative pad.
- Light weight, compact design.
- Comes complete with all installation parts and humidistat control.
- Capacity: 13 gal/day (50L/day)

GeneralAire

GF-81
GeneralAire Legacy Drum Humidifier.

- 16 gal. per day
- A portion of the heated air from the furnace passes through a water-soaked pad where it absorbs additional moisture and then returns for distribution throughout your home.
- Inspection window to easily check the condition of your vapor pad and water pan.
- Easy-Access Lift-Off Cover
- Split drum design allows easy removal of evaporator sleeve
- Includes MHX3 Manual Humidistat
- Capacity: 16 gal/day (60L/day)



100's of parts for any brand

GENERAL Aire

Honeywell

Desert Spring Products

Aprilaire

Lau Industries

HVAC





Instantly transform baseboard heaters from ugly to awesome!

The Do It Yourself installation process does not require the use of any tools or hired help.

“Elliptus” Style, now available!



Elliptus is the first radiator cover to use the gentle curve of an ellipse to add elegance!

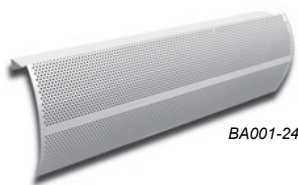

BA001-24



EC005-RT

EC005-LF

EC006-RT

EC006-LT

CP005

WB001

Elliptus Style Panels

- BA001-24** 24" Length Panel
- BA001-36** 36" Length Panel
- BA001-48** 48" Length Panel
- BA001-60** 60" Length Panel
- BA001-72** 72" Length Panel
- BA001-84** 84" Length Panel
- EC005-RT** Closed Right Side End Cap
- EC005-LF** Closed Left Side End Cap
- EC006-RT** Open Corner Right Side
- EC006-LF** Open Corner Left Side
- CP005** Solid Coupler Piece
- WB001** Wall Bracket*

Elliptus is the first radiator cover to use the gentle curve of an ellipse to add elegance! * Only needed if floor to top measurement is 7-1/4" or less, the back plate has already been removed, or you are installing baseboard heaters in a new construction.



BC001-72

Baseboarders Basic Panels

- BC001-36** 36" Length Panel
- BC001-48** 48" Length Panel
- BC001-60** 60" Length Panel
- BC001-72** 72" Length Panel
- EC004-RT** Closed Right Side Endcap
- EC004-LF** Closed Left Side Endcap
- CP004** Solid Coupler Piece
- IC004** Inside Corner 90°
- WB001** Wall Bracket*

Easy slip-on baseboard heater covers. One-size-fits-most geometry. Made of a lighter 24 & 22 Gauge steel. Clean & modern at a great price. * Only needed if floor to top measurement is 7-1/4" or less, the back plate has already been removed, or you are installing baseboard heaters in a new construction. **Two year guarantee not to rust.**

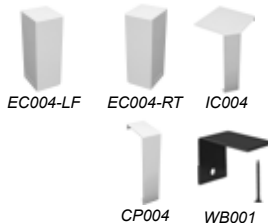

EC004-LF

EC004-RT

IC004

CP004

WB001

Measuring Guide



Use this helpful guide for measuring. If your measurements qualify you are good to use either of these 6-3/4" Basic or Premium models.

If your measurements do not qualify you will need the WB001 wall bracket.

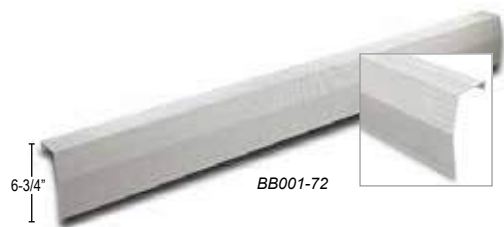

BB001-72

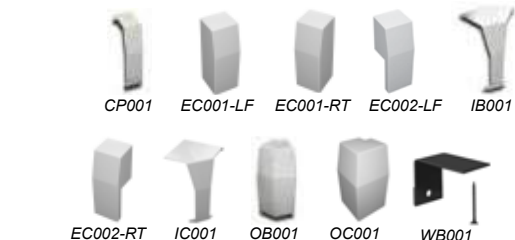

CP001

EC001-LF

EC001-RT

EC002-LF

IB001

EC002-RT

IC001

OB001

OC001

WB001

Baseboarders Premium

- BB001-24** 24" Length Panel
- BB001-36** 36" Length Panel
- BB001-48** 48" Length Panel
- BB001-60** 60" Length Panel
- BB001-72** 72" Length Panel
- BB001-84** 84" Length Panel
- EC001-RT** Closed Right Side Endcap
- EC001-LF** Closed Left Side Endcap
- EC002-RT** Open Right Side Endcap
- EC002-LF** Open Left Side Endcap
- CP001** Perforated Coupler Piece
- IC001** Inside Corner 90°
- IB001** Inside Corner 135° (Bay Window Appl.)
- OC001** Outside Corner 90°
- OB001** Outside Corner 135°
- WB001** Wall Bracket*

Easy slip-on baseboard heater covers. The original one-size-fits-most geometry. 22 Gauge panels, 18 Gauge endcaps. Visually melts into any type of home decor. * Only needed if floor to top measurement is 7-1/4" or less, the back plate has already been removed, or you are installing baseboard heaters in a new construction. Lifetime guarantee not to rust. **Also available in tall 8-3/4" height**

Honeywell



D-HZ316N
Honeywell Ceramic Heater.
- Black finish.
- 1500 watt adjustable thermostat
- Variable heat settings
- Overheat protection
- High quality safety plastic back-up thermal circuit breaker.

H005135
Prestige Portable Ceramic Heater.
- Power indicator light
- 2 heat settings 750W and 1500W
- 4 position switch
- Adjustable thermostat
- Safety protection

king



KP1210 48"
King Electric portable baseboard heater.
- 1000W, 120v, 8.3A
- Built-in thermostat
- Safety tip-over switch
- 6ft cord and plug
- 3-1/8"W x 7-1/4"H x 48"L

king



PHTR-9
King Quartz Radiant Tower Heater
- 600/1200W 2 heat settings
- Adjustable thermostat
- Tip over & overheat protection
- 6ft cord and easy carry handle

king



PUH1215T
King Portable Personal Utility Heater
- 750/1500W 2 heat settings
- 216CFM fan, adjustable thermostat
- Ceramic element
- 6ft cord and easy carry handle

king



Warning Requires 240V 30 amp NEMA 6-30R receptacle

PGH2448TB
King Garage/Shop Heater
- 240/208V, 4800/3600W
- SureStop limit protection
- Wall/ceiling bracket
- 6ft cord, SS element

king



KBP1230



KBP-K2

KBP1230 950W to 2850W 120V
KBP2406 950W to 5700W 240V
KBP-K2 6ft cord kit for KBP2406
King Electric Garage/Shop Heater.
Pic a watt allows choice of wattage. 16ft air throw, built-in thermostat
13.5"H x 10.5"W x 11.5"D, 26lbs

king



PH-16
King Comfort Cube Fan Heater
- 750/1500W, adjustable thermostat
- Ceramic element, safety features
- Hi/Low/Fan only and off settings
- 6ft cord, overheat protection

king



EKB2440TB
King Electric Garage/Shop Heater.
Quick heat 3850W element, long life bearing motor, universal mounting bracket, 240V, 20A, 2 pole, 600sqft coverage, built-in thermostat

king



PHM-1
King Electric Portable Utility Heater.
1300/1500W, 120V, 4 position fan only/low/high/off, Safety tip-over switch, 6ft cord, carrying handle, adj. thermostat

king



PSH1215T
King Electric Mini Portable Heater.
Yellowjacket, 1500W, 120V, 216CFM fan, 6ft cord, Adj. tilt control and heat settings, comfort handle

king

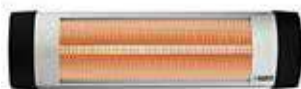

RSH1215
King Electric Radiant Infrared Quartz Heater
- 1500W, 120V
- Wall/ceiling mounting bracket
- Aluminum housing

king



PSH2440TB
King Yellow Jacket Junior Portable Heater
- High power 3750 watts, 20amp, 13,000BTU
- 300CFM fan, 6ft cord
- Good for areas up to 450sqft

king



SRP126-6 6'
SRP126-12 12'
SRP126-18 18'
SRP126-24 24'
SRP126-50 50'
SRP126-75 75'
King Electric Self Regulating Heating Cables. For a variety of pipe freezing protection appl. Suitable for metal & plastic pipes, 16ga wire, 6w/ft at 4°C, will not overheat when overlapped, pre-terminated w/30" grounded plug and end splice.

dyson

Visit us online for
our full selection of Dyson fans and heaters!

www.amresupply.com



GLACIER

New!



F000300 12"
High velocity floor/desk fan. 3 speed, 120V. Adjustable tilt head.

Looking for something more permanent?
Visit page 86 for our selection of ceiling fans

GLACIER

Oscillating



F000505 16"
Oscillating Desk Fan. 3 speed, 120V, easy assembly. Ideal for home, office or light commercial use.

CANARM



HVF18F 18"
Canarm High Speed Floor/Table Fan. 3 Speed, 1/5HP, 120V, 6ft cord, tilt adjustments, Can be wall mounted, 3800CFM on high speed

CANARM



WMKD24-3SP 24" Stationary
WMKD24-OSC 24" Oscillating
Canarm Commercial Circ Fan. Creates a gentle air movement. 3 Speed thermally protected motor, industrial grade aluminum blades, OSHA guard, c/w 10' 120V grounded cord, wall mounting hardware. 30" also available.

CANARM



PBKD30-3SP 30" Stationary
PBKD30-OSC 30" Oscillating
Canarm Commercial Circulating Fan. 3 speed, 1/4HP, 120V, non oscillating, 10ft cord, thermally protected motor

GLACIER



F000625 20"
Glacier Box Fan. 3 Speed rotary switch, plastic grills and blades



GLACIER



F000555 16"
Glacier Oscillating 16" Pedestal Fan 3 Speeds, adjustable height, 120V, with cord & plug, easy assembly.



Helping you stay cool.

FRIGIDAIRE

Frigidaire® Home Comfort Collection. Efficient designs save you energy and are better for budgets and the environment. Cost saving features, such as Energy Saver function, which maximizes energy efficiency while keeping you comfortable. The ultimate flexibility, with features like our remote control thermostats, you can create a relaxing atmosphere that adapts to your needs.

Call for quantity buys!

5 YEAR WARRANTY ON ALL MODELS!

WINDOW UNITS



Model # BTU Size H x W x D
FFRA0511U1 5,000 12" x 16" x 15-1/4"
Frigidaire Window A/C.

Mechanical thermostat, 2 fan speeds, 2 cool settings, 2-way air direction, anti-bacterial mesh filter

Model #	BTU	Size H x W x D
FFRE0533U1	5,000	12" x 16" x 15-1/4"
FFRE0633U1	6,000	13-7/16" x 18-1/2" x 15-1/2"
FFRE0833U1	8,000	13-7/16" x 18-1/2" x 17-1/2"
FFRE1033U1	10,000	14-1/2" x 19" x 21-1/2"
FFRE1233U1	12,000	14-1/2" x 19" x 21-1/2"

Electronic controls, 3 fan speeds, 3 cool settings, 8-way air direction, remote control, anti-bacterial mesh filter, auto fan, energy saver mode, sleep mode, filter check function, 24 hour on/off timer, clean air ionizer.



WINDOW UNITS - Vertical

Model #	BTU	Size H x W x D
FFRS0822S1	8,000	20-1/4" x 14-1/5" x 23-1/2"
FFRS1022R1	10,000	20-1/4" x 14-1/5" x 23-1/2"

Electronic controls, 3 fan speeds, 3 cool settings, 4-way air direction, remote control, anti-bacterial mesh filter, auto fan, energy saver mode, sleep mode, filter check function, 24 hour on/off timer, clean air ionizer.

DEHUMIDIFIERS 24 hour on/off timer.

Model #	Per Day	Size H x W x D
FFAD3033R1	30 Pint	20-1/2" x 13-13/16" x 10-1/2"
FFAD5033R1	50 Pint	24-7/16" x 15" x 11-5/8"
FFAD7033R1	70 Pint	24-7/16" x 15" x 11-5/8"
FFAP7033T1	70 Pint w/ Pump	24-7/16" x 15" x 11-5/8"

Frigidaire Dehumidifiers.

Electronic thermostat, 2 fan speeds, energy star, low-temp operation, bucket full indicator, auto shut off, continuous drain feature, anti-bacterial filter, digital humidity readout, check filter light, 24 hour on/off timer.



WINDOW UNITS



New!



Model #	BTU	Size H x W x D
FGRC0844U1	8,000	13-7/16" x 18-1/2" x 16"
FGRC1044T1	10,000	14-1/2" x 19" x 24-5/8"
FGRC1244T1	12,000	14-1/2" x 19" x 24-5/8"

Wi-Fi cool your room anywhere, anytime from your smart device. Works with Amazon Alexa and with The Google Assistant. Sleek new design. Effortless scheduling with the Frigidaire Smart App. 115V. 3 fan speeds, 3 cool settings.

THROUGH THE WALL UNITS

Model #	BTU
FFTA0833U1	8,000
FFTA1033U1	10,000
FFTA1233U1	12,000

Frigidaire Through The Wall A/C.

Electronic Control, Universal Fit TTW Remote Control, 115V. 14-1/2"H x 24"W x 20-1/2"D

Accessories

EA108T Through the wall sleeve, 18"D (Sleeve cut-out dimensions 15-5/8"H x 25-15/16"W)

EA109T Through the wall decorative grille



PORTABLE UNITS

with heat no heat



Model #	BTU	Size H x W x D
FFPA0822U1	8,000	27-11/16" x 13-9/16" x 14"
FFPA1022U1	10,000	27-11/16" x 13-9/16" x 14"
FFPA1222U1	12,000	30-1/8" x 18-5/16" x 15-5/8"
FFPA1422U1	14,000	30-1/8" x 18-5/16" x 15-5/8"

MODELS WITH HEATER 4,000 BTU Heat

FFPH1222U1	12,000	30-1/8" x 18-5/16" x 15-5/8"
FFPH1422U1	14,000	30-1/8" x 18-5/16" x 15-5/8"

Frigidaire Portable A/C.

Single hose, elec. controls, 3 fan speeds, 3 cool settings, oscillating air swing, remote control, low volt. start-up, sleep mode, filter check function.





Check the **Amre website** for our full selection of in stock compressors!



R414B
REPLACES
R-12 R409A
R-500 R-416A
R-134A R-420A
R-401A RB-276
R-401B
Refrigerant



R410A
Air Conditioning
Refrigerant



R422B (NU22B)
REPLACES
R-22 R-407C
R-417A R-422D



R134A
Refrigeration and HVAC
Refrigerant



944KIT
AC/R Leak Sealant HVACR super seal. Professional formula for most residential systems. 1 1/2 Ton/5.3 KW



971KIT
Leak Sealant Super seal Total 1 maintenance kit. Small systems. 230 btuh/.067KW 18,000 btuh 1 1/2 Ton /5.3 KW



972KIT
Leak Sealant Super seal Total 2 maintenance kit. 1.5 ton/5.3KW up to 5 ton/17.6KW



947KIT
AC/R Leak Sealant Super seal. Small systems. 230 btuh/.067KW systems up to 18,000 btuh/5.3 KW



973KIT
Leak Sealant DryR Moisture eliminator. Prevents acid formation, increases efficiency and life cycle of unit.



946KIT
Leak Sealant Super Seal Premium Pro™ kit. Permanently seals leaks and great for preventive maintenance.

New!



DV-4E
JB Eliminator
Vacuum Pump,
4CFM.



84-FT-30 Foam Tape
1/8" x 2" x 30'



VAC235Q 1 Quart
VAC235G 1 Gallon
Vacuum Pump Oil

84-PT-30 Cork Tape
1/8" x 2" x 30'



357-20 18oz
Saf-N-Kleen™ Aerosol Solvent Coil Cleaner. High-solvency formula quickly and easily dissolves



358-20 19oz
Foam-Plus™ Aerosol Foaming Coil Cleaner Heavy-duty foaming detergent coil cleaner in an aerosol can. Non-flammable and water-based.



TRIPLE-D-RTU-FC 32oz
Triple-D Coil Cleaner. Degreaser, detergent, deodorizer. Non-Foaming. Metal safe and fin friendly.



CCHD-1G 3.78L
All Temp Heavy Duty Coil Cleaner. Self-rinsing coil cleaner. Removes stubborn deposits. For outdoor use only



58CT 1/2" x 6'
78CT 3/4" x 6'
Foam Pipe Insulation. Semi-slit 25/50 rated gray closed cell.



70-AF1500
15" x 24"
70-AF1525
24" x 25ft
Universal Air Conditioning Foam Filter. Use with any brand that takes a foam filter, can be cut to size. 1/4"



4210463RW
Condenser coil cleaning brush. Cleaning coils improves efficiency and saves energy on cooling equipment with accessible coils.



UFC1 Universal Fin Comb.



FCR6
Fin Comb Set. 6 of the most popular size fin comb sizes to straighten and clean evaporator and condenser fins.



Class A:	Ordinary combustibles such as wood, cloth, and paper
Class B:	Flammable liquids such as gasoline, oil, and oil-based paint
Class C:	Energized electrical equipment, incl: wiring, fuse boxes, circuit breakers, machinery & appliances

Part #	Size	ULC Rating
21008346	2.5	1-A, 10-B:C
21008350	4	2-A:10-B:C
21008347	5.5	3-A, 40-B:C
21008348	10	4-A, 60-B:C
21008349	18	6-A, 80-B:C

This line of extinguishers utilize a multi-purpose dry chemical agent suitable for Class A, B, and C fires. These extinguishers can address any and all of your specific fire hazard needs. c/w wall brackets. #466400 (vehicle bracket) for 4lb and 5lb, order separate.



- AA65** Padlock
- AA12** Keyed for Peel Region



Fire Safety Plan Boxes 13"H x 13"W x 4"D
 - weather resistant
 - highly visible reflective graphics
 - include key tags
 - mounting screws/wall anchors and either (2) padlocks or (2) keys depending on locking system required.

NOTE: Boxes being installed in the City of Toronto require Padlocks (AA65). Boxes being installed in the Region of Peel requires Keys for Peel Region (AA12). Check with your local Fire Department for locking system requirements.



Steel Fire Extinguisher Cabinet
 Surface Mount, Removable Front Panel Can Be Padlocked White E-Coat Finish.

Part#	Model	D	W	H
FXC-5	2-1/2 - 5lb	5"	8"	20.5"
FEC-10	10lb	6.25"	10.5"	24"



FLB291
 Fire Log Book #291 Canadian Edition. This nationally accepted log book has over 100 pages of forms to record all your fire protection equipment maintenance duties. Step-by-step procedures detail the inspections and tests for: Fire Alarm, Emergency Lighting, Exit Lights, Emergency Power Systems, Fire Separation, Portable Fire Extinguishers



ML-165
 Fusible Link. 165degF, 1-10lb load rating, 1" centers, 1-1/2" bearing length. Used commonly on fire dampers, mechanical door releases for fire doors and other uses.



GL-004K Mirtone 10/pk
FA06 Couch/IBM 10/pk
27165P Edwards each
 Pull station replacement glass break rods



STI-1100



STI-1200



STI-1250

Stopper II (Fits virtually any pull station)

STI-1100 Flush mount with horn
STI-1200 Flush mount without horn
STI-1250 Flush mount water resistant without horn
STI Protective Polycarbonate Cover. Helps stop false alarms. Easy install. for flush mount. UL Listed, FM Approved. Horn models have choice of 95dB or 105dB. Spacer adds 2" depth. See website for full size specs.

Please consult with local authorities regarding rules & regulations of replacing and/or repairing fire alarm monitoring systems.

MS-401
 Single stage metal pull station N.O. Durable aluminium and finished in red. An abrasion resistant label w/large, raised letters provide clear legible instructions. These stations are non-coded, single or double action devices which initiate an alarm when pulled.



AA44
 Fire Service Key Box. Red metal box with reflective fireman's hat for high visibility. Designed to hold the building's service keys. Equipped with (2) breakaway padlocks, common identification building key tags and mounting hardware. 5.5"H x 4"W x 3.5"D



STI-6400
 Exit Stopper Multifunction Door Alarm
 - Helps prevent unauthorized exits/entries
 - 95 or 105 dB alarm
 - Set for 30 seconds, 3 minutes or indefinitely
 - Can be used as an annunciator



STI-6200
 Fire Extinguisher Theft Stopper
 - Alarm helps prevent theft and misuse
 - Mounts easily next to extinguisher
 - 95 or 105 dB alarm when activated
 - Deactivation cable for maintenance





WS27
Break-Off Heavy Cast Aluminium Fire Dept. Cap with red enamel paint. Includes (2) J-Bolts made of corrosion-resistant metal. Fire Department simply breaks the cap with hydrant wrench to gain access to the swivel connections. Great for theft protection. Overall size: 3.5"



WS03
Break-Off Cast FD Connection Cap. Great for theft protection! This "Easy-Off (Kwikap) Cap" is designed to be secured internally on the inside female thread of the swivel connection. Set flanges are adjustable to suit any 2.5" (65mm) female hose thread. Overall size: 3.375" x 3.375"



G-112
Self-Adhesive Glow-in-the-dark flexible vinyl Exit sign. Glows up to 8hrs. Very visible in normal lighting. Will not wear out. Abrasion resistant. Adheres to non-porous surfaces like cement block, brick, unpainted drywall, etc.) Red lettering on phosphorescent background. 12" x 8"



SIG32A
High Quality Glow-in-the-dark Plastic Exit Sign. 12" x 8". Includes (2) self-adhesive arrow stickers. Durable, non-electrical, non-toxic, non-radioactive, explosion proof, minimal installation and maintenance expense, washable. Easy installation: Two-sided tape on reverse. 5 minutes of light exposure (fluorescent, mercury vapour or metal halide light) on the face will provide 26+ hours of illumination.

Signage



BL-106
Sign. "Fire Extinguisher - In Case Of Fire Break Glass". Self adhesive. 2" x 6"



BL167
Sign. "Fire Door Keep Closed". Self adhesive. 6" x 12". UV ink



G-113
Self-Adhesive Glow-in-the-dark flexible vinyl Arrow sign. Glows up to 8hrs. Very visible in normal lighting. Will not wear out. Abrasion resistant. Adheres to non-porous surfaces like cement block, brick, unpainted drywall, etc.) Red arrow on phosphorescent background. 8" x 5"



SIGA37
High Quality Glow-in-the-dark Arrow, Plastic. 14 x 3.5". 5 minutes of light exposure (fluorescent, mercury vapour or metal halide light) on the face will provide 26+ hours of illumination. c/w 2 sided tape.



BL-115



BL-174

BL-174 8" x 5"
BL-115 8" x 10"
Self adhesive no smoking sign.



SI65FB
3D First Aid Sign, 5"W x 6"H per face. Plastic, 3D angle mount, flush side panels equipped with holes for mounting.



SI99E
3D Eyewash Station Sign, 5"W x 6"H per face. Plastic, 3D angle mount, flush side panels equipped with holes for mounting.



SI57
3D Fire Extinguisher Sign, 4"W x 12"H per face. Plastic, 3D angle mount, flush side panels equipped with holes for mounting.



SI14
90° Fire Hose Sign, 4"W x 18"H. Plastic, 90 degree mount, two-sided sign equipped with holes for mounting.



Direction	Rigid Standard	Glow-in-the-dark
Down/Left	SI88A	SIG88A
Down/Right	SI88B	SIG88B
Up/Left	SI88C	SIG88C
Up/Right	SI88D	SIG88D

Stairwell Exit 8"W x 8"H. Plastic. Equipped with tape on reverse for mounting. (Up/Left shown)



SI75SP
Surveillance Sign, 6"W x 6"H. Plastic. Equipped with tape on reverse for mounting. Can also be drilled to interior or exterior wall or siliconed to rough surfaces.



SI01 Vinyl Sticker
SI01P Plastic
SI01SA Silver Alum.
SI01SG Gold Alum.
Emergency procedure sign for buildings with a single-stage fire alarm and elevators. This wording option also includes extended caution instructions. 4"x7"



SI02 Vinyl Sticker
SI02P Plastic
SI02S Silver Alum.
SI02SG Gold Alum.
Emergency procedure sign for buildings with a single-stage fire alarm and NO elevators. This wording option also includes extended caution instructions. 4"x7"

First Aid

Regulation Kits - Plastic



Kits contain economic bulk supplies that can be readily accessed when needed. They are ideal for manufacturing settings where a wide variety of first aid items are required. All kits are weatherproof and plastic containers. All North bulk kits are ANSI Z308.1-2003 compliant. Check with your local government agencies for minimum requirements, specific kits may be required in each province.

Ontario

- WCB
- 830020E** #1: 1-15 employees
- 830025E** #2: 16-200 employees

Manitoba

- 8311300** Standard Kit 1-25 employees

Saskatchewan

- 8312100** #1: 1-9 employees
- 8312200** #2: 40 - 99 employees

Alberta

- 8311400** #1: 1-15 employees
- 8311500** #2: 10-49 employees
- 8311800** #3: 100+ employees

British Columbia

- 8311100** Basic Level 1 6-30 employees

New!



878 Container
878-500 Internal Liner
 Frost Stainless Steel Biomedical Sharps Disposal System. Once full, just throw whole internal liner away.

Eye Protection



Part # Lens
7092500BLM Blue Mirror
7092500AFC Clear
7092500YEL Yellow
 Black Frame Wide-Vision Safety Glasses. Integrated silicone nose pads. Impact resistant polycarbonate lenses provides 99.9% UV. Scratch resistant coating.



Part # Lens
7037000AFC Clear
7037000IOM Indoor Mirror
 Spider X-10 Safety Glasses
 Soft PVC wraparound frame with foam liner inside the lens frame. Complete with temple arms with strap attachment. Features a polycarbonate lens with 99.9% UV. Impact Resistant Lens. CSA/ANSI Z87.1



Part # Arms/Lens
7095000CLR Clear
7095000YEL Yellow
7095000GRY Grey
 Jazz Jammer Safety Glasses
 Light-weight wrap -around design. Molded nose-piece. Frameless PC Lens construction with scratch resistant coating. Impact Resistant polycarbonate lens provides 99.9% UV protection. ANSI Z87.1/CSA Z94.3-07



7020000CLR
 Fits over most prescription eyewear. Also can be worn as regular safety glasses, very good coverage, wide field of view. Lenses are protected by North's exclusive 4A coating (anti-fog, anti-scratch, anti-UV, anti-static)



7091000CLR
 JS200 Light-weight Impact resistant Nylon Frame, nose piece, bayonet style temples, polycarbonate lenses, 99.9% UV, scratch resistant coating, ANSI Z87.1/CSA Z94.3-07.



7240000
 Head gear only
72R4501PCC
 Visor for head gear
 Polypropylene molded face protector. Adj. ratchet suspension, Leatherette sweatband, tension knobs for easy visor positioning
 Flip-up visor, visor sold separate



G1100
 Gaurdian EyeSafe™ faucet -mounted eyewashes convert any faucet into an emergency eyewash station without interfering with normal faucet operation, diverter valve w/pull knob, 55/64"-27 female thread w/adaptors (15/16"-27, 13/16"-27 and 3/8" IPS)



S19-200B
 Bradley Faucet Mounted Eye-wash Station. Universal Mount for Standard and Gooseneck Faucets. 55/64" x 27 thread (male). c/w adapters 15/16" x 27 (female) and 13/16" x 27 (female)



32-000454-0020 16 oz. bottle
32-000455-0020 32 oz. bottle



32-000460-0020 w/16 oz bottle
32-000461-0020 w/32 oz bottle
 Wall station eye wash.



7501
 Portable gravity operated eyewash station. FDA approved (34.1 L) tank. ABS plastic eyewash heads with .4 gpm (1.5 L). Flow rate over 15 min. Label-mounted operating & maintenance instructions. Stainless steel wall bracket (unit must be hung).
 Additive not included - Order separately.



Respiratory Protection



75301500 Small
75302500 Medium
75303500 Large
 ValueAir Small Basic Half Mask. Elastomeric construction for comfort, efficiency, and cost effectiveness.



770030S Small
770030M Medium
770030L Large
 North 7700 Series Half Mask. Silicone facepiece material conforms to facial features. Easy to clean, extremely durable. Can be adapted to PAPR or Supplied Air.



75S5200 Medium
 3000 Series Soft Silicone Facepiece. NIOSH Approved. Lightweight, collapsible headstrap easy to adjust with a "drop down" comfort crown for rest position. Recommended for Paint, Pesticides, Lead Abatement, Asbestos, Mold Abatement etc...

Don't be bugged by bugs!

Visit page 283 for our selection of insect repellents



N75003 2/pk
 North Safety organic vapors and acid gas cartridge. NIOSH approved, Can be used for the North 5500, 7700, 5400 and 7600 Series face pieces.



75105005 each
 P100 Particulate Filter (99.97% Minimum Filter Efficiency).



75105310 each
 P100 S Series filter cartridge for respiratory masks. Organic Vapour/ Acid Gas.

Economical



7401100 50/box
 Disposable comfort mask for protection against non toxic dust & pollens. Not NIOSH approved.



7450200 5/pk.
 General purpose dust masks. Full mouth and nose protection.



7450100 3/pk
74002AO 20/pk
 N95. Approved for 95% efficient protection against non-oil particulates.



74006AO 10/box
 Odyssey N95 Masks w/valve Approved for 95% efficient protection against non-oil particulates. For welding on aluminum or steel. Soft pre-shaped nose cushion and adjustable headstrap

Hearing Protection



77200AO 6 pairs/pk
77200AO 200/pk
 DePlug Disposable Ear Plug NRR 29. Specially formulated polyurethane foam material offers excellent comfort and is non-allergenic. Tapered fit shape provides effective and comfortable fit



7751000 3pr/pack
 DePlug Tapered Fit Polyurethane NRR 29 Corded Ear Plugs

New!



7758500-RET
 Earplug Band Hearing Protector. Meets CSA & ANSI requirements. Easy to clean.

DEGIL

77008AO
 Degil XP 008 Headband Earmuffs. Designed for professional use for Xtreme protection. NRR 26dB, meets CSA Class "A"
 Spacious cups for most ear sizes
 Wide shaped ear cushions with pressure equalization air openings



7870100 12"
7870105 18"
 Traffic cone orange. Non reflective

Head Protection

Other colours available



81CHP00WHT White
81CHP00YEL Yellow
 Head-Guard Pinlock ANSI. Provides crown impact & penetration force transmission protection and dielectric protection up to 20 kV. Shell molded from 100% high density polyethylene. Weight 12 oz. Nape strap wraps around the bottom of the back of the head to provide incredible stability and helps to keep the hat in position when bending over. Complete with P.P.E. slots that accommodate a variety of protective equipment such as earmuffs, face shields, etc.

Other colours available on request.



81CR000WHT White
81CR000YEL Yellow
 Wave CSA Type 2 Ratchet Suspension Hard Hat. Provides crown and lateral impact & penetration force transmission protection and dielectric protection up to 20 kV. 100 % high density polyethylene with special UV radiation protection additive. Low profile design for comfort, stability, and compliance. 17oz (481grams), multi-positional suspension adjustment, flame retardant foam liner, Heat exhaust & Rain channels





PVC-45W
Nitrile Bib-style apron, multipurpose.
35" x 45". 20ml

Great for
Bed Bug
Protection!



8214270M Medium
8214270L Large
8214270XL X-Large
GenVec Coverall w/El hood/wrist/ankles. Zippered front, serged seams w/elastic wrists, ankles, hood w/face opening. Microporous Material.

Great for
Bed Bug
Protection!



82P3070-M Medium
82P3070-L Large
82P3070-XL X-Large
Gen Vec Lite Disposable Coveralls. Polypropylene 40 gsm material with sewn seams, zipper front, attached hood, elasticized face opening, elastic wrists and ankles.



7825301-RET Orange
7845375-LXL Lime Green
7825376LXL Lime Green
Reflex 5 point tear away vests.

Great for
Bed Bug
Protection!



8214600
Shoe Cover, 100/pk
Made of lightweight. Durable tear and puncture resistant material that will not absorb liquids.



SHUBEEDB 50/pk Regular
SHUBEEDBWP 40/pk Waterproof
Shubee Original Shoe/Boot Cover. For service industry professionals. Prevents tracking dirt and dry debris. Strong, breathable material. Fits up to size 18 boot.



9550
Non woven polypropylene shoe covers. Textured bottom for skid resistance. Elastic on top for easier on/off. Extra pliable material for greater flexibility in movement. 100 per bag, sold by the bag

Prevent slips
and falls!



MY-12201
Ice Cleats.
Aggressive spike helps prevent dangerous slips and falls, one size fits most, durable material for long lasting effectiveness.

CleanBoot

Part# Shoe Size
02011 8-10
02004 10-12
02035 13-16
Reusable Boot/Shoe Cover.
Slips on and off easily without lacing or ties, Unique carpet grip sole, Reusable durable fabric is easily cleaned.



8537010-25 25ft
8537010-50 50ft
Pro Series Roofers Kits - Packaged in a durable carry bucket. Basic Harness, vertical lifeline, 3 ft Shock Absorbing Lanyard. Panic Model A.



85-009-00
Fallpro Supreme Full Body Harness, lightweight breathable back support pad. Fully adjustable 5 points for max comfort (2 shoulder, 2 leg and 1 chest). Padded leg straps.



8513310-E4
6' Shock pack lanyard w/snap hook gate strength 3.6K. Lightweight, 3/4" die-cut snap hooks, heat-cut to prevent fraying, user weight 100-254lbs



8526500 50ft
8527500 100ft
Vertical lifeline w/snap hook



8511100
6 ft Web Lanyard with locking snap hooks. Forged Steel Double Locking snap hooks at each end. Connecting device in a personal fall arrest, work positioning or travel restraint system



85010-1D-STD
Basic Full Body Harness. Standard size, adjustable dorsal D-ring, adjustable chest strap, 3-point comfort adjustment, sewn pelvic strap

Back Support/Harnesses



10-10000-LRG Large
10-10000-XLG X-Large
Super Economy back support with sewn on suspenders

Knee Protection



9224
Knee pad - Tradesman Super lightweight comfort, double adjustable straps, extra foam protection, thick soft inner lining, Black



9223
Heavy Duty Knee pads. Super lightweight comfort. Single adjustable 1-1/2" wide strap. Thick soft inner lining.

24 HR.



Order by
4pm for
24-48hr shipping
to almost anywhere in
Canada!





1033-M M
1033-L L
1033-X XL

Watson Hard Time Gloves
- "Be safe, be seen" hi-vis orange and reflective fingertips
- Microfibre/PVC palm
- Heavy duty TPR impact protection on fingers, thumb and knuckle bar



1010-M M
1010-L L
1010-X XL

Watson The Shank Gloves
- "Be safe, be seen" hi-vis orange and reflective fingertips
- Microfibre palm
- Heavy duty TPR impact protection on fingers, thumb and knuckle bar



1095-M M
1095-L L
1095-X XL

Watson The Yardbird Gloves
- "Be safe, be seen" reflective fingertips and strips
- Microfibre palm
- Slip-on style cuff



1098-M M
1098-L L
1098-X XL

Watson Jail Break Gloves
- "Be safe, be seen" hi-vis orange reflective fingertips and piping
- Microfibre palm
- Neoprene knuckle bar provides protection



Made for a Woman's Hand



1012-S S
1012-M M
1012-L L

Watson JailBird Gloves
- "Be safe, be seen" hi-vis orange reflective fingertips and strips
- Microfibre/PVC palm
- EVA knuckle bar provides protection



1051-M M
1051-L L
1051-X XL

Watson The Breakdown Gloves
- Cut level 5
- AX Suede Microfibre/Silicone palm
- Heavy duty TPR impact protection on fingers, thumb and knuckle bar

Made for a Woman's Hand



198S S
198M M
198L L
Womens Fresh Air Gardening Glove.

- Air flow mesh back
- Microfibre palm
- Hooded fingertips & knuckle bar
- Snug fit elastic wrist w/velcro closure

New!



314 Men
307 Women
Game of Thorns Long Gardening Gloves.
- Hard-wearing microfibre leather.
- Synthetic leather laminated PVC gauntlet cuff.



005-M M
005-L L
005-XL XL

Watson Flextime gloves.
- Full grain goatskin leather palm.
- Leather hooded fingertips & knuckle bar reinforcement
- Form-fitting spandex back.
- Snug fitting elastic wrist with secure velcro closure

Extreme Work Armour



010BK-M M
010BK-L L

Watson Extreme Work Armour Gloves
- Microfibre palm
- Foam padded palm patches
- Spandex back
- Silicone printed fingertip
- PVC thumb
- Fingers and knuckle bar

One size fits all



104X
Leather Gloves.
- Economy
- Split cowhide leather
- Cotton drill back
- Elastic wrist

Premium Full-Grain Leather



4002-L L
4002-XL XL
Red Baron Work Glove.
- Full-grain cowhide leather
- Cotton drill back
- Shirred elastic wrist
- Slip-on style safety cuff

Work Armour



004-M M
004-L L
004-XL XL

Wingman Work Glove.
- Microfibre palm
- Hooded fingertips
- Form-fitting spandex back
- Shirred elastic wrist
- Slip-on style cuff

412-M M
412-L L
412-XL XL

Watson #TapThat Glove.
- 13gg fine nylon shell
- Nylon/Lycra liner with New Foam Nitrile conductive coating on palm and fingertips
- Works on all touch screen devices- Snug-fitting seamless knit wrist



399-S S
399-M M
399-L L
399-XL XL

Watson True Grit Hi-Vis Gloves.
Fully dipped HPT™ coating with unique crisscross patterned palm. "Be safe, be seen" with hi-vis safety yellow Slip-on style neoprene cuff for easy on/off



6926-L L
Lightweight, breathable 8oz cotton flannel keeps hands cool and comfortable. Snug-fitting knit wrist.

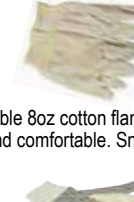

5501
8 oz. Cotton Glove. Stronger grip with PVC Dots. Glove breathability pulls sweat away from hands for comfort.



322-M M
322-L L
322-XL XL

Flash Lite Glove
- High visibility poly/cotton
- Seamless knit with a rubber coated palm.

390-S S
390-M M
390-L L
390-XL XL

Watson Stealth.
- Black on black
- Nitrile coated gloves
- Breathable nylon back.



353-S S
353-M M
353-L L
353-XL XL

Watson Stealth Dynamo gloves.
- Cut level three.
- Aramid fiber shell with foam
- Nitrile coating
- Cut resistance
- Superior wet grip.



393-L L
393-XL XL

Watson Stealth Slip Stream gloves.
- Foamed nitrile coating
- Extreme grip,
- Triple thread seamless
- Knit shell for comfort & strength,
- Ergonomic fit.





9374-M M
9374-L L
9374-XL X-L
 - Heavyweight 'Heat Lok' lining
 - Exceptional comfort and warmth
 - Soft & breathable cotton fleece shell
 - Drivers style



94006HW-L L
94006HW-XL X-L
 - Winter Lined
 - Full grain cowhide
 - 3M Thinsulate™ C100 lining
 - Reinforced knuckle bar
 - Hooded fingertips
 - Rubberized safety cuff

6/pk



603-L L
 Winter glove liner, perfect for added warmth in cold conditions. Snug fit wrist, poly cotton blend.



9005W-M M
9005W-L L
9005W-XL X-L
 Watson Flextime Winter gloves.
 - 3M Thinsulate™ C40 lining
 - Full grain goatskin leather
 - Spandex back Elastic wrist & Velcro® closure



9281 One Size
 North Paws Thinsulate Gloves. Warm 3M superior hand protection in cold conditions. Great for: Construction, Farm & Ranch, General Purpose, Industrial



9396-L L
9396-XL X-L
 Watson velcro closure, polar fleece, microfoam nitrile coating resists oils, acids, caustics and alcohol. Excellent grip in both wet and dry conditions.



9502-M M
9502-L L
9502-XL XL
 North of 49 gloves. 3M Thinsulate™ LiteLoft lining is a high density lightweight material to ensure maximum warmth in cold climates.



9503-L L
9503-XL XL
 North of 49 mitts. 3M Thinsulate™ LiteLoft lining is a high density lightweight material to ensure maximum warmth in cold climates.



9010W-M M
9010W-L L
9010W-XL XL
 3M Thinsulate™ C40 lining. Heavy-weight microfibre foam padded palm. Fingers and knuckle bar, Snug-fitting neoprene wrist with secure Velcro® closure.



9403-M M
9403-L L
9403-XL XL
 Thermal lining. Hard-wearing double-dipped sandy foam nitrile coating, hi-vis safety yellow nylon seamless knit. Water resistant barrier. Snug-fitting knit wrist



302-M M, 12/pr
302-L L, 12/pr
302-XL XL, 12/pr
 Watson Gloves Junk Yard Dog
 - Heavy duty rubber latex palm
 - Superior abrasion resistance.
 - Sure-grip crinkle textured
 - Exceptional wet/dry grip.
 - Poly/cotton seamless knit shell

Sherpa Lined!

New!



94002-L L
94002-XL XL
 Red Baron Sherpa Lined Work Glove.
 - Full-grain cowhide leather
 - Shirred elastic wrist
 - Slip-on style safety cuff

Repellents

Protect yourself with trusted high quality products!

New!

Sunscreens

11101
 Doktor Doom Maximum Strength Mosquito Repellent 30% Deet, 230g

99501
 Doktor Doom Jungle Juice Deet Free Insect Repellent 200gram Eco Can Spray

99500
 Doktor Doom Jungle Juice Deet Free Insect Repellent 100mL Pump Spray

12435
 Croc Bloc Heavy Duty Aerosol Insect Repellent.
 28.50% DEET Formula
 150G / 5.29oz

12435A
 Croc Bloc Insect Repellent Pump Spray.
 30% DEET Formula
 120ml / 4oz.

12405
 Croc Bloc Insect Repellent Towelette.
 30% DEET Formula
 5.8GM

Convenient Single Use!

12340
 Croc Bloc Broad Spectrum Sunscreen SPF30
 4oz / 120ml bottle.

Extra Large!
12350
 Croc Bloc Broad Spectrum Sunscreen SPF30
 34oz / 1000 ml Bottle with pump.

Convenient Single Use!
12310
 Croc Bloc Broad Spectrum Sunscreen SPF30
 10ML Packet.





Don't let the bed bugs bite!



11606 450g
66305 682g
Kills Bed Bugs and residual control of bed bugs. Long lasting residual insecticide. Excellent for mosquitos, ants, face flies, horn flies and stable flies.

Not Approved for use in BC or Ontario

44404 400g(14.29 oz)
Kills Bed Bugs
"Hi-Pressure Fogger" ideal for use in areas with a heavy infestation of insects. Use in larger areas - unscented. Flushes insects from hiding and kills once in contact. 1 oz. treats up to 1000 cubic feet.

Approved for all provinces

PRO PICK

44303 70g
44202 150g
BED BUG FOGGER - Kills Bed Bugs. "Hi-Pressure Fogger" ideal for use in areas with a heavy infestation of insects. Use in larger areas - unscented. Flushes insects from hiding and kills once in contact. 1 oz. treats up to 1000 cubic feet.

Not Approved for use in BC or Ontario

Looking for an effective and humane way to deter birds?
Let AMRE help you design a bird spike solution!
1-800-661-9891

66303 500g
House & garden insecticide spray - Kills Bed Bugs. Offers long term RESIDUAL control and contact kill of bed bugs. Unscented, also works on cockroaches, fleas, ticks, aphids etc.

Not Approved for use in BC or Ontario

88101 500g
Indoor/outdoor insecticide - Kills Bed Bugs
Contact spray only – you must spray the bug to kill the bug and has NO RESIDUAL ACTIVITY – this is ideal for use on mattresses and other fabrics where bed bugs are present. Unscented

Not Approved for use in BC or Ontario

99204 525g
Wasp & Hornet Spray
Works from up to 20ft away. Rapid contact kill and residual kill when return to nest

44808 400g
Foaming spray works up to 8ft away. Instant kill and knockdown.

Approved for all provinces

22101 170g
Metered Release Insecticide. Fits most standard metered dispensers. Unscented. Dispense for 30 days at 7.5 minute intervals. Covers 6000sqft.

Approved for all provinces

22109 500g
Sleep Tight Bed Bug Spray. Indoor space and contact spray. Works on most insects including ants and cockroaches

Approved for all provinces

22201 300g
Bed Bug & Household Insect Blaster. Maximum strength household space and contact pest spray. Works on most insects including ants, cockroaches etc.

Approved for all provinces

22103 500g
60 Day Residual Cockroach and Insecticide Spray. Extremely effective 60day control of roaches. Works on other insects including Bed Bugs.

Approved for all provinces



For a full selection of
Pest Control products!
www.amresupply.com/
Safety > Pest Control > Bedbug Control





330431
Blackout Heavy Duty Bedbug Interceptor.
 A more rigid stronger furniture leg mount bed bug climb up stop. Put on furniture leg to prevent infestation from mattresses etc...



330394 CLIMB UP
 A simple but effective means to establish if Bed bugs exist and prevent moving up to the mattress. Simply place under each leg or castor of the mattress/boxspring support frame.

New!



99403
Pest Pistol. Insecticide powder applicator which is used to control insects. Use to disperse Pyrethrin Powders and Diatomaceous Earth Powders.



Great for ants and bed bugs



99202 600g
Insecticide Powder. Premium Pyrethrin. Doktor Doom Go Green. Effective against ants, cockroaches, silverfish, spiders, earwigs, sowbugs, crickets, certain beetles, boxelder bugs, fleas, bed bugs etc...



Great for ants and bed bugs



99208 200g
99300 1Kg
Baited Insecticide. Contains Diatomaceous Earth. Doktor Doom Go Green. Use as dust or spray. Indoor/Outdoor. Effective against ants, fleas, silverfish, spiders, wasps, earwigs, bed bugs, beetles and many more...



Great for ants and bed bugs

328705 200g
The Exterminator Professional Insect Dust.
 Targets ants, roaches, bees, wasps, bed bugs, spiders and much more.

Great for ants and bed bugs



328702 200g
328713 900g
Insectigone Crawling Insect Killer Dust.
 For successful control of ants, roaches, bees, wasps, bed bugs, spiders and much more.



99502 3.8L
Wipeout Ready To Use Indoor-Outdoor Residual Insecticide.
 Kills Ants, Carpet Beetles, Cockroaches, Crickets, Earwigs, Silverfish, Sow bugs and Spiders.

Great for ants and bed bugs



99407 5Kg Pail
BeGreen Premium Fresh Water Diatomaceous Earth Insect Killer. Commercial Grade.
 Ready-for-use insecticide dust effectively knocks down and kills a huge range of pests including ants, bedbugs, cockroaches, beetles, fleas etc. Apply with hand or power dusters.



313082 482g
Konk 499. Crawling insect killer. Indoor/outdoor. Great for ants, spiders, cockroaches and more



Tip! Use #99206 directly into ant hill and surround the area with #11606 to create a barrier and eliminate the nest!



99206 544g
Foaming Residual Outdoor Ant Eliminator. Nozzle and formula are designed to produce a foam that reaches ants where they hide.

To be used with bait traps ONLY



440103 1Lt
Green Way ant killer bait. To be used only with bait traps. Ants will take back to kill colony.



440104
Ant bait cafe station. For use with ant bait.



For a full selection of our **Safety products!**
 visit www.amresupply.com/Safety>





CM-812SD
Moth Traps. 2/pk includes pheromone lures that will attract moths up to 12ft radius.



CM-915
Gold Stick Fly & Wasp Trap. Perfect for those who prefer inconspicuous control. Plan on window sills or hang in areas of high activity. Use indoor or outdoor. 1" x 10"



CM-9144SD
Bug & Fly Catcher. 4 Rolls per package. No dangerous chemicals. Fast and safe with no odour. Catches flies and bugs 1-1/2" x 25"



CM-724
Baited insect and roach glue traps. Tent style. Lay flat against baseboard etc... Once in trapped forever just throw away and replace with new trap. 4 traps per package.



453361
Yellow Jacket Bee/Wasp Trap. Easy to use container for catching flies, bees and wasps. Use with liquid attractant.



CM-602
Mechanical Mouse Trap. Classic snap trap provides a fast kill with instant trigger response. Contains 2 pieces



CM-402
Scent baited glue trap scented with peanut butter. Larger size for larger pests like rats. 5-1/4" x 10-3/8". For larger pests its is recommended to tape or stick to floor.



CM-102
Mouse catcher - glue trap, non toxic, disposable and ready to use. Contains 2 pieces



CM-606
Trap w/1 Glue Board
CM-48-72
2pk Repl. Boards
Multicatch Mouse Trap. Galvanized box with 2 entrance doors see-thru lid. No setup or assembly required. Child and pet safe. Traps over a dozen mice. Reusable. Use with glue trap or live catch trap.



453103 Rat Trap
453106 Mice Trap
Trapper T-Rex captures rodents with a ferocious snap of its patented teeth. Superior trigger sensitivity and velocity make rodent escape virtually non-existent. Easy, safe baiting.



453201 Black
Multi-Catch Mouse Trap.
More attractive design with easier to clean tunnel. No window.



454011 Ketch All Mouse Traps
454058 Clear View Lid
Wind-up mechanical trap captures up to 20 mice. Paddle wheel is triggered when mouse reaches centre of tunnel. Constructed of galvanized metal. Order clear lid separate for easy viewing.



453204 Black
Little Pete Narrow Multi-Catch Mouse Trap. Half the size of conventional models, fits in areas larger sizes will not.

Note: The 6 panel name has changed but you can still count on the same quality. Bostonian is now Colonist.

JELD-WEN WINDOWS & DOORS *Ask us about special orders and customizing options!*

The Colonist® has a textured surface with a modified cove and bead sticking profile



Colonist Moulded Panel - Hollow Core
Colonist Six Panel Interior Door Slab, 1-3/8"

BOSTSLAB18X80	18" (1'6") x80"
BOSTSLAB24X80	24" (2'0") x80"
BOSTSLAB28X80	28" (2'4") x80"
BOSTSLAB30X80	30" (2'6") x80"
BOSTSLAB32X80	32" (2'8") x80"
BOSTSLAB34X80	34" (2'10") x80"
BOSTSLAB36X80	36" (3'0") x80"

*6'8" (80") standard height, textured finish



Bostonian Moulded Bi-Fold - Hollow Core
Bostonian Six Panel Door, 1-3/8"

BOSTBIFOLD18X80	18" (1'6") x80"opening
BOSTBIFOLD24X80	24" (2'0") x80"opening
BOSTBIFOLD30X80	30" (2'6") x80"opening
BOSTBIFOLD36X80	36" (3'0") x80"opening

*Approximate finished height is 78-3/4" made to fit 80" openings. For larger openings use 2 of the above sizes. (EX: for a 5 ft. opening use 2 x 30")

special quotes available on large jobs



Primed Hardboard - Hollow Core
Flush Interior Door Slab, 1-3/8"

PHSLAB18X80	18" (1'6") x80"
PHSLAB24X80	24" (2'0") x80"
PHSLAB28X80	28" (2'4") x80"
PHSLAB30X80	30" (2'6") x80"
PHSLAB32X80	32" (2'8") x80"
PHSLAB34X80	34" (2'10") x80"
PHSLAB36X80	36" (3'0") x80"

*6'8" (80") standard height



JELD-WEN WINDOWS & DOORS

Primed Hardboard Bi-Fold - Hollow Core
Flush Door, 1-3/8"

PHBIFOLD18X80	18" (1'6") x80"opening
PHBIFOLD24X80	24" (2'0") x80"opening
PHBIFOLD30X80	30" (2'6") x80"opening
PHBIFOLD36X80	36" (3'0") x80"opening

*Approximate finished height is 78-3/4" made to fit 80" openings. For larger openings use 2 of the above sizes. (EX: for a 5 ft. opening use 2 x 30")

special quotes available on large jobs



ACCORDIAN DOORS

The Via Accordian Doors offers value and durability in a solid PVC panel door with flexible vinyl hinges. 6' 8" high. Pre-assembled, track and hardware included.

VIA

Part#	Size	Colour
VS3680K	36"W X 80"H	OAK
VS3680H	36"W X 80"H	WHITE
VS4880K	48"W X 80"H	OAK
VS4880H	48"W X 80"H	WHITE



Other models available give us a call!



JELD-WEN WINDOWS & DOORS

The Jeld-Wen difference, Quality counts!

Not all items available at all locations. Subject to additional freight costs on out of local city delivery locations.

Hollow Core - MDF Frame

- 1-3/8" Door
- 1-5/32" MDF Top + Bottom rails
- Blocking behind panels for support
- 2 Particle board lock blocks
- 1/8" HDF Facings
- (construction may vary by region)

Special Order Options

- Solid Core
- 1-3/4" Door
- 8' Height

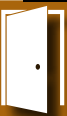

RESIDENTIAL GRADE - LOCKSETS - knobs & Levers



Villa - Professional - All Metal Parts

Function S. Steel (C32D) Pol. Brass (C3) Satin Chr. (C26D)
 Passage **34-FV5334 34-FV1134 34-FV1334**
 Privacy **34-FV5324 34-FV1124 34-FV1324**
 Entrance (Keyed) **34-FV5314 34-FV1114 34-FV1314**
 Locksets featured here are 6-in-1 adj. latch, drive-in or mortise. 2-3/8" or 2-3/4" backset. Lifetime mechanical warranty Weiser compatible keyway.



Basic Ball - Builders Series

Function Satin Chrome (C26D)
 Passage **36-D4205SC**
 Privacy **36-D4203SC**
 Entrance (Keyed) **36-D4210SC**
 Locksets are 4-in-1 adj. latch, drive-in or mortise. 2-3/8" or 2-3/4" backset. Lifetime mechanical warranty Weiser compatible keyway.

Builders Series



Hampton - Professional - All Metal Parts

Function S. Steel (C32D) Satin Chr. (C26D)
 Passage **33-D7434 34-FV7634**
 Privacy **33-D7424AR 34-FV7624**
 Entrance (Keyed) **33-D7464AR 34-FV7664**
 Locksets featured here are 6-in-1 adj. latch, drive-in or mortise. 2-3/8" or 2-3/4" backset. Lifetime mechanical warranty Weiser compatible keyway.

Harrison - Builders Series

Function Satin Chr. (C26D) Satin Nickel (C15)
 Passage **36-D8205SC 36-D8205SN**
 Privacy **36-D8203BSC 36-D8203BSN**
 Entrance (Keyed) **36-D8210CSC 36-D8210CSN**
 These levers include 4-in-1 adj. latch for drive-in and mortise, fully reversible, Fit doors 1-3/8" to 1-3/4" thick, easy to install, all metal construction, 25y mechanical warranty. Fire rated available

New!

Builders Series



Orleans - Builders Series

Function Satin Chr. (C26D) Satin Nickel (C15)
 Passage **36-D8305SC 36-D8305SN**
 Privacy **36-D8303BSC 36-D8303BSN**
 Entrance (Keyed) **36-D8310CSC 36-D8310CSN**
 These levers include 4-in-1 adj. latch for drive-in and mortise, fully reversible, 2-3/8" or 2-3/4" backset. Fit doors 1-3/8" to 1-3/4" thick, easy to install, all metal construction, 25y mechanical warranty. Other finishes available

Builders Series



Perspective - Builders Series

Function Satin Chrome (26D)
 Passage **36-D6205SC**
 Privacy **36-D6203SC**
 Entrance (Keyed) **36-D6210SC**
 Locksets are 4-in-1 adjustable latch, drive-in or mortise, 2-3/8" or 2-3/4" backset, Weiser compatible key-way on keyed lever.

New!

Builders Series

RESIDENTIAL GRADE - DEADBOLTS



Single Cylinder - Professional

S. Steel (C32D) **33-D4364**
 Pol. Brass (C3) **33-D4164**
 Satin Chr. (C26D) **33-D4964**

Double Cylinder - Keyed on both sides

S. Steel (C32D) **34-FV437**
 Pol. Brass (C3) **34-FV417**
 Satin Chr. (C26D) **34-FV497**
 Professional series, Lifetime mechanical, 5 yr. powder finish warranty. 6 in 1 universal latch. Drive-in or mortise, 2-3/8" - 2-3/4" backset. Weiser compatible keyway. Full 1" deadbolt for security, 2pc. prevents access by wrench or crow bar, high security strike.

LIGHT COMMERCIAL - DEADBOLTS



Single Cylinder - Commercial Grade

Function Satin Chrome (C26D) Stainless Steel (32D)
 Mortise **32-F470 32-F450**
 Grade 2 Light comm/res. deadbolt - single cylinder. Schlage "C" 6 pin compatible keyway 2 3/4" Backset. 3 hour fire rated.



Beverly

Function Bronze/Satin Chrome, (9/26D)
 Passage **WAC101**
 Privacy **WAC301**
 Entrance (Keyed) **WAC501**
 Storeroom/Exit **WAC581**

Locksets featured here are 6-in-1 adj. latch, drive-in or mortise. 2-3/8" or 2-3/4" backset. Lifetime mechanical warranty Weiser compatible keyway.



Single Cylinder - Commercial Grade

Bright Brass (C3) Satin Chrome (C26D)
D9471X3 D9471X26D

Grade 2 Light comm/res. deadbolt - single cylinder. Adaptable to Doors 1 1/4" to 1 3/4", 2 3/8" & 2 3/4" Backset, 6 way latch drive-in mortise



The Smart alternative to mastering!
 Perfect for property management!

Concealed master cylinder



Single Cylinder

GD9471-X26D-SMTBSL Satin Chrome (26D)

Dual Cylinder

GCD9571-26D-SMTBSL* Satin Chrome (26D)
 Weiser Deadbolt with Smart Keyway. Grade 2 light duty commercial/residential. Fits 1-3/8" to 1-3/4" with 2-3/8" or 2-3/4" backset. Mortise latch style. Other finishes available. *Dual cylinder allows mastering of top concealed cylinder

24 HR.



Order by **4pm for 24-48hr shipping**
 to almost anywhere in Canada!





DRIVE-IN: *old style* MORTISE: *old style*

LEGACY

Mortise

- A52460SL** 2-3/8" - 2-3/4" adj. Passage/Privacy
- A52460DL** 2-3/8" - 2-3/4" adj. Entrance (Keyed)

Drive-In

- A50469** 2-3/8" - 2-3/4" adj. Passage/Privacy
- Weiser Legacy Old Style Latches
Latches fit Weiser knobsets prior to 2010 and current Beverly style. *Please call for newer style latches 2010 and later.*

New!

Mortise

- 820061-26D** 5" Deadlatch (Keyed)
 - 820046-003** 5" Deadbolt
- Weiser Latches
Fits most new Weiser entry knobs and deadbolts from 2018



Taymor Locksets Only

Mortise

- 33-SS9098** 5" Deadlatch (Keyed)
 - 33-SS9099** 5" Deadbolt
- Taymor latch, for **knob sets only**, won't fit levers.
Stainless Steel (C32D)

STRIKES



- 33-SS9101** St. Steel
 - 33-PB9101** Pol. Brass
 - 33-SS9111** St. Steel
 - 33-PB9111** Pol. Brass
 - 33-PB9112** Polished Brass
- 1 1/8" X 2 3/4" "T" Type w/adj. tab 1 1/8" X 2 3/4" Square Corner 1" X 2 1/4" Deadbolt Strike

044-SPEED Semi-Automatic Ilco Key cutting machines. Cuts auto, residential and commercial keys. *See web for specs and additional models*

045-SPEED Manual Ilco Key cutting machines. Cuts auto, residential and commercial keys. *See web for specs and additional models*



LKG-001
5-N-1 Key Gauge, For Kwikset, Schlage, Weiser, Weslock, and Master.
Small size (3-3/8" x 2-1/8")



LFT005 5/set
Plug followers, light weight, Durable, White Delrin, reflects light for pinning. (2) schlage, weiser, universal and kwikset



115S
Cylinder springs (short) Phosphor Bronze, Compatible with Kwikset, Sargent, Weslock, Weiser, and Yale Cylinders .115 Short Vial/100 per Pack

Popular Keys:

- FALCON** - 50pk
 - A1054WB**
 - KWIKSET** - 50pk
 - 1176** (1063KW)
 - SCHLAGE** - 50pk
 - 1145C** (5 Pin) "C"
 - 1145E** (5 Pin) "E"
 - 1145F** (5 Pin) "F"
 - 101C** (6 Pin) "A"
 - A1145E** (6 Pin) "E"
 - 101F** (6 Pin) "F"
 - WEISER** - 50pk
 - W1555** (WR5)
- Also Taymor compatible.
For newer style Weiser locks use blank 1176



Other brands available, see our website!
www.amresupply.com



- #2 MASTER**
 - #3 MASTER**
 - #4 MASTER**
 - #5 MASTER**
 - #6 MASTER**
 - #7 MASTER**
 - #8 MASTER**
 - #9 MASTER**
- Master Cylinder Pins 50/Pk.



- #0 BOTTOM**
 - #1 BOTTOM**
 - #2 BOTTOM**
 - #3 BOTTOM**
 - #5 BOTTOM**
 - #6 BOTTOM**
 - #7 BOTTOM**
 - #8 BOTTOM**
 - #9 BOTTOM**
- Bottom Cylinder Pins 50/Pk.



GRAPHITE 30 g
Microfine, Greaseless, Odourless, Prevents Freezing & Lubricates



33-9375W Taymor Only
LCR005 Brands below
Cylinder Cap Removal Tool. Time saving tool to remove the cylinder caps from Schlage, Weiser, Arrow, and Falcon Cylinders.



WSR115
Constructed of Heavy-Duty Steel
Leak proof Seal-Tight Cover
8 Brass Master Pins - sizes: 2-9
Brass Driver Pins
10 Brass Bottom Pins - sizes: 0-9
Cap Retaining Pins
Cylinder Springs
Dim: 11-1/4" x 8-1/2" x 1-7/8"



LIKSW
Schlage and Weiser Rekeying Kit (Institutional)
Dual-View Pin Tray. Pin sizes are enlarged and printed under a clear plastic tray, both above and inside the pin pockets for easy viewing at all angles. C/W Schlage & Weiser top and bottom pins, master pins, pins and springs



LMDWSR
Mini Weiser Rekeying Kit
Made of Super-Tough Polyethylene
8 Brass Master Pins - sizes: 2-9
Brass Driver Pins
10 Brass Bottom Pins - sizes: 0-9
Cylinder Springs
Dimensions: 8"x5"x1-3/4"



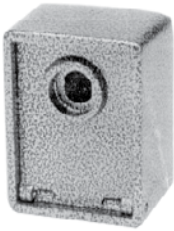

Community specific boxes (excluding blank)

Safety and High Security Key Boxes

A high security key box system designed to give immediate access to locked buildings, elevators & other secured areas. Installation will allow faster access in case of an emergency. It will also prevent expensive forcible entry that sometimes results from emergency services being required.

Part#	Community	Part#	Community
AL-FD-STA	St. Albert, AB	AL-FD-E	Edmonton, AB
AL-FD-FHM	Fort McMurray, AB	AL-FD-L	Lethbridge, AB
AL-FD-MOO	Moosejaw, SK	AL-FD-REG	Regina, SK
AL-FD-SAS	Saskatoon, SK	AL-FD-SP	Sherwood Park, AB
AL-FD-WIN	Windsor, ON	AL-FD	BLANK

Others available on request.

75900 1"

Give away rings, 1000/box, made of zinc-plated steel spring wire



100/box Dia.

76200 3/4"

76400 1"

50/box

77000 2"

Nickel plated tempered steel rings, holds multiple keys securely. Resilient tempered steel won't lose shape even after repeated use



KEYTAG

2-3/16" x 1-1/8", paper insert: ring 3/4". Assorted colours available. Sold each



28229 1-1/4" Dia. 25/pk

Sturdy metal-rimmed white paper tags. Ideal as price tags or product identification tags. Overlapping ring attached



ID45

Universal key cabinet tag. 1-1/2" x 1-5/8", ring 3/4". Assorted colours available. 25/pk



KEKAB-TAG-NT

20/pkg (pre-numbered)

KEKAB-TAG

100/pkg. (blank)
Fibre Key Tags, white, with hooks



Plastic

- KL980/50BLACK** black
- KL980/50RED** red
- KL980/50DKBLUE** blue
- KL980/50GREEN** green
- KL980/50YELLOW** yellow

Key tags, 50/pk. Other colours available



43651LL

Black

Super 48 Key Bak®, Very high-quality key reel with 48" retractable pull. Kevlar® cord. Clip on belt only. Ball-and-socket locking mechanism. Heavy-duty polycarbonate case



001365C

Pushbutton key safe. Holds up to 5 keys. Convenient storage for multiple users. Size: 4.13" x 2.53" x 2.22". Securely mounts to any wall or flat surface.



001406

Pushbutton portable key safe. Holds up to 3 keys. Convenient storage for multiple uses. Sturdy metal with rubber shell. Size: 4.44" x 5.75" x 1.8"



001795 30 Keys 12.04" x 8.11" x 3.19"

001796 60 Keys 19.53" x 13.62" x 4.76"

001797 120 Key 19.53" x 13.62" x 4.76"

Steel key cabinet with keyed cam lock and 2 keys. Includes numbered key tags with key rings and lock location chart. Superior strength, more depth for larger key rings, keys hang directly on hooks.



Hook Style

Metal Mailbox Key Cabinets - Surface Mount

Part#	Description	Size
4908A	10 - Key Cabinet	9-1/2"H x 5-1/4"W x 1-3/4"D
4908B	15 - Key Cabinet	12" H x 10" W x 3" D
4908C	30 - Key Cabinet	12" H x 10" W x 3" D
4908D	60 - Key Cabinet	12" H x 10" W x 3" D
4908E	100 - Key Cabinet	22" H x 16" W x 3" D
4908F	200 - Key Cabinet	22" H x 16" W x 3" D
4908G	300 - Key Cabinet	22" H x 16" W x 6" D c/w lock, plastic key tags and chart.

RIOPEL



KEKAB Style

Single-Tag KeKabs®

Part#	Description
KEKAB-80	80 - Key Cabinet
KEKAB-120	120 - Key Cabinet
KEKAB-240	240 - Key Cabinet
KEKAB-330	330 - Key Cabinet

Single-Tag KeKabs® - HPC's single-tag key security control system, c/w lock and key



AMRE has the tools to get the job done

Shop online

www.amresupply.com



DOOR STOPS



25-P4634N Nickel
25-P4634B Brass
 Wide angle hinge Pin Door Stop w/Rubber Stop



25-4650SR Silver
 Kick Down Door Stop. 5"H, cast iron construction



J4573 Chrome
 Floor Door Stop with rubber bumper. 2"H, Solid brass construction. Threads in then has extra screw to hold in place. Meets ANSI



25-4671B Brass
25-4671N Nickel
 Spring Flex Door Stop, c/w Screw & Base, Plastic Tipped 3-1/8" L



J4547 Br. Chrome
 Floor Stop, 3-1/4" Tall, Brass. Cast brass door bumper with rubber; brushed chrome finish; mounts to floor. Meets ANSI standards.

24 HR.

 Order by
 4pm for
 24-48hr shipping
 to almost anywhere in
 Canada!



74PB
 Jumbo Wedge Door Stop. Plastic



J4592
 Floor Stop
 Wrought steel with soft resilient rubber bumper, used on undercut doors up to 1-1/2".



25-4613SS
 Architectural door stop. Stainless steel type 304, black rubber bumper. 1-9/16"H x 1-11/16"Dia. Screw included.

Door Chains



25-D3080SC Satin Chr.
 Door Guard w/screws alternative to the weld chain type door guard allows partial door opening while deterring forced access.



37-4805 Brass
 Chain Door Guard, solid Brass, complete with screws.



25-D4804SC Satin Chr.
 Chain Door Guard, welded steel chain, complete with screws.

25-4610DN Satin Nickel
 Door Stop, High Profile, c/w Screws & Expansion Shields



25-4611DC Dull Chrome
25-4611DN Satin Nickel
 Convex Wall Stop



25-4612DC Dull Chrome
25-4612DN Satin Nickel
 Concave Wall Stop



25-4608AL Aluminium
 Architectural riser for use with 4609 & 4610

Door Viewers

25-D4846B Brass
25-D4846N Nickel
Door Viewer 180° Angle Of Vision, 9/16" Bore Size, Adj. 1 3/8" to 2 1/4" plastic lens



25-D4841B Brass
25-D4841N Nickel
Door Viewer 160° Angle Of Vision, 15/32" Bore Size, Adj. 1-3/8" to 2-1/8" plastic lens



Fire Rated - 1.5 HRS.
37-B4820N Nickel
Door Viewer 160° Angle Of Vision, 15/32" Bore Size, Adj. 1-3/8" to 2-1/8" glass lens



Fire Rated - 1.5 HRS.
37-B4825N Nickel
Door Viewer 180° Angle Of Vision, 9/16" Bore Size, Adj. 1-3/8" to 2-1/4" glass lens



8000 SERIES PLAIN BEARING

- Residential butt hinges
 - Comes with #8 x 3/4" screws for both 3" x 3" & 3-1/2" x 3-1/2" hinge size
 - Comes with #9 x 3/4" screws for 4" x 4" hinge size
 - Packed in pairs w/screws in individual box.



1/4" RADIUS



1/4" Radius
Satin Chrome C26D
 3" x 3" **25-PK8345A**
 3-1/2" x 3-1/2" **25-PK8345B**
 4" x 4" **25-PK8345C**

5/8" RADIUS



5/8" Radius
Satin Chrome C26D
 3" x 3" **25-PK8346A**
 3-1/2" x 3-1/2" **25-PK8346B**
 4" x 4" **25-PK8346C**

SQUARE CORNER



Sq. Corner
Satin Nickel C15
 3" x 3" **25-PK8244A**
 3-1/2" x 3-1/2" **25-PK8244B**
 4" x 4" **25-PK8244C**

4100 SERIES

Commercial 4-1/2" x 4" Template butt hinges

- Conforms to government and commercial standards
- Made exact in size, gauge of metal, and screw hole location
- Meets or exceeds BHMA/ANSI - A156.1 Grade 2 requirements
- Ball bearing type hinges must be used on door in conjunction w/door closers & all fire-rated openings
- Full mortise type
- Three pieces (1-1/2 pairs) per set
- Full set machine and wood screws incl.

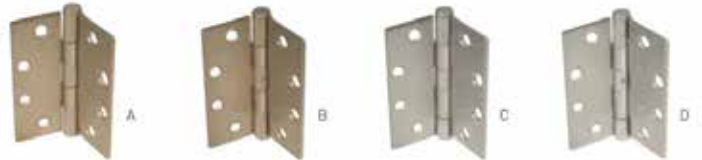

4-1/2" x 4" Template Sq.

- A. Plain bearing butt hinge
- B. Non-removable pin plain bearing butt hinges
- C. Ball bearing butt hinges
- D. Non-removable pin ball bearing butt hinges

Satin Nickel C15
25-4169N
25-4170N
25-4172N
25-4173N

Satin Chrome C26D
25-4172DC
25-4173DC

3300 SERIES

Single action spring hinges

- C-UL listed for fire doors
- Conforms to ANSI specifications
- Easily adj. spring tension
- One hinge package per box



3-1/2" x 3-1/2"
5/8" RADIUS



4" x 4"
1/4" RADIUS



4-1/2" x 4"
SQUARE

1/4" Radius single action spring hinges

- 3-1/2" x 3-1/2" single action spring hinge
- 4" x 4" single action spring hinge

Dull Brass C4
25-3311DBB
25-3311DBC

Satin Chrome C26D
25-3311DCB
25-3311DCC

5/8" Radius single action spring hinges

- 3-1/2" x 3-1/2" single action spring hinge
- 4" x 4" single action spring hinge

25-3312DBB
25-3312DBC

25-3312DCB
25-3312DCC

Sq. Corner single action spring hinges

- 3-1/2" x 3-1/2" single action spring hinge
- 4" x 4" single action spring hinge
- 4-1/2" x 4" single action spring hinge

25-3310DBB
25-3310DBC
 -

25-3310DCB
25-3310DCC
25-3310DCD

Amre also supplies a full selection of commercial door hinges

www.amresupply.com



DSP-135-32D For Deadbolts
SP-135-32D For Knobsets
 Scar Plate used to convert 2-3/8" to a 2-3/4" backset;
 3-1/2 OD. 32D satin stainless steel finish



BF-161-SL Silver
 For covering 2-1/8" hole filler plates

BF-178-SL Silver
 For covering 1-1/2" hole filler plates
 Also available in polished brass



Door Wrap Arounds

Please note: other models and finishes available - give us a call!

For Cylindrical Door Locks w/2-1/8" hole, recessed



Part#	Backset	Door	Colour
1-PB-CW	2-3/8"	1-3/8"	Polished Brass
1-S-CW	2-3/8"	1-3/8"	Stainless Steel
2-PB-CW	2-3/8"	1-3/4"	Polished Brass
2-S-CW	2-3/8"	1-3/4"	Stainless Steel
3-PB-CW	2-3/4"	1-3/8"	Polished Brass
3-S-CW	2-3/4"	1-3/8"	Stainless Steel
4-PB-CW	2-3/4"	1-3/4"	Polished Brass
4-S-CW	2-3/4"	1-3/4"	Stainless Steel
55-PB-CW	5"	1-3/4"	Polished Brass
55-S-CW	5"	1-3/4"	Stainless Steel

All above models have 2-1/8" hole size. Dimensions vary, see website for specs.

For Deadbolts w/1-1/2" hole, recessed



Part#	Backset	Door	Colour
5-PB-CW	2-3/8"	1-3/8"	Polished Brass
5-S-CW	2-3/8"	1-3/8"	Stainless Steel
6-PB-CW	2-3/8"	1-3/4"	Polished Brass
6-S-CW	2-3/8"	1-3/4"	Stainless Steel
7-PB-CW	2-3/4"	1-3/8"	Polished Brass
7-S-CW	2-3/4"	1-3/8"	Stainless Steel
8-PB-CW	2-3/4"	1-3/4"	Polished Brass
8-S-CW	2-3/4"	1-3/4"	Stainless Steel

All above models have 1-1/2" hole size. Approx. 4" x 4-1/2"

For Cylindrical Door Locks w/2-1/8" hole, recessed



Part#	Backset	Door	Colour
51-PB-CW	2-3/8"	1-3/8"	Polished Brass
51-SS-CW	2-3/8"	1-3/8"	Stainless Steel
61-PB-CW	2-3/8"	1-3/4"	Polished Brass
61-S-CW	2-3/8"	1-3/4"	Stainless Steel
71-PB-CW	2-3/4"	1-3/8"	Polished Brass
71-S-CW	2-3/4"	1-3/8"	Stainless Steel
81-PB-CW	2-3/4"	1-3/4"	Polished Brass
81-S-CW	2-3/4"	1-3/4"	Stainless Steel

All above models have 2-1/8" hole size. Approx. 4" x 4-1/2"

Dbt. lockset 2-1/8" top hole, 2-1/8" bottom hole, recessed w/5-1/2" centres



Part#	Backset	Door	Colour
256-PB-CW	2-3/8"	1-3/4"	Polished Brass
256-S-CW	2-3/8"	1-3/4"	Stainless Steel
258-PB-CW	2-3/4"	1-3/4"	Polished Brass
258-S-CW	2-3/4"	1-3/4"	Stainless Steel

All above models are approx. 4" x 12"

Dbt. lockset 1-1/2" top hole, 2-1/8" bottom hole, recessed w/4" centres

Part#	Backset	Door	Colour
484-PB-CW	2-3/4"	1-3/4"	Polished Brass
484-S-CW	2-3/4"	1-3/4"	Stainless Steel

All above models are approx. 4" x 9"



U9567 Brass 1-3/4"
U9976 Stainless Steel 1-3/4"
 Door edge reinforces and repairs door edge. Assists in preventing forced entry. Use on wood or metal doors with mortise or drive-in latches. Accommodates lockset or deadbolt with any backset. 1-3/8"W x 4-1/2"H x 1"D



U9492 Stainless Steel
 Entry Deadlock Blank Door Repair Cover
 1-3/4"W x 4-1/2"H x 4-5/16"D

Commercial

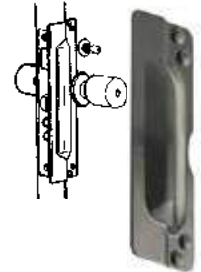

LP-207-PB 2-3/4" X 7" Pol. Brass
LP-207-SL 2-3/4" X 7" Silver Coated
LP-207-DU 2-3/4" X 7" Duro Coated
LP-211-PB 3" X 11" Pol. Brass
LP-211-SL 3" X 11" Silver Coated
LP-211-DU 3" X 11" Duro Coated
 Blocker Plate Defenders for Outswinging Doors, Heavy Gauge Steel, fits 2-3/4" and 2-3/8" backsets, c/w mounting hardware



LP-307-SL Silver Coated
LP-307-DU Duro Coated
 Reversible, fits over cylinder, lock removal NOT required, 3/8" offset. 2-5/8" x 7" x 1/8"

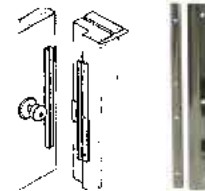

ILP-212-SL Silver
ILP-212-BP Brass
 Door Defenders, Interlock for Swinging Doors, Protects Latch, Interlocks Door & Frame, Resists Jimmying & Prying



25-3082DC Dull Chrome
 Angle Plate Protects Door from damage caused by misplaced solid bar of door guard.



U9244
 Wall protector
 Protects interior walls from impact damage by shielding contact point of wall and door knob. Repairs damaged walls. 5", Vinyl, white

Kick Plates



Size	Satin Aluminium
8" X 28"	25-KP828
8" X 30"	25-KP830
8" X 32"	25-KP832
8" X 34"	25-KP834
10" X 34"	25-KP1034

Pkg. w/Robertson Screws, 0.50 gauge, Suitable for Metal/Wood Doors



Order by **4pm for 24-48hr shipping** to almost anywhere in Canada!

www.amresupply.com Up to 30% of a typical energy bill could be saved by making your home more airtight.

STOP the draft!
We have all your
weatherstripping
needs covered.
www.amresupply.com

WINDOW



Sill & Patio

DOOR



Interior. Jamb
& Thresholds

HVAC



A/C. Water
Heater &
Ventilation

SPECIALTY



Auto. Plumbing.
Electricity &
Insulation

Climaloc.



CF10190 Aluminum
CF10194 Brown, PVC
CF10196 White, PVC
RCR 36" threshold, white or brown
PVC with vinyl bumper or heavy
duty extruded aluminum with vinyl
bumper, screws incl.

Climaloc.



CFRP190
RCR 36" (91cm) Vinyl Bumper
Threshold Insert For 10190

Climaloc.



CF10534 Brown
CF10535 White
RCR 36" doorsweep, PVC in white
or brown with vinyl sweep, screws
incl.

Climaloc.



CF10530 Silver
CF11535 White
CFRP530 Vinyl refill only
RCR 36" doorsweep, aluminum
extrusion w/vinyl sweep, screws incl.

Climaloc.



CF10570 White
Interior 36" Door Sweep with fiber
bottom.

H.D.
Climaloc.



CF10600 Silver
RCR 36" doorsweep, incl. fastener-
s, aluminum with heavy duty
reinforced rubber sweep

H.D.
Climaloc.



CF20536 Grey
Aluminum and neoprene 36"
doorsweeps, heavy duty strength

Climaloc.



CF10574 Brown
CF10575 White
RCR 36" (91cm) "U" Shaped
Doorsweep,
all vinyl

Climaloc.



CF20574 Brown
CF20575 White
RCR 36" "U" shape vinyl
doorsweep with fibers and rain
deflector

Climaloc.



CF74065
Slide & Save Door Bottom. Insulates heat
and great to keep out odors! Easily glides on
carpets, wood, tile etc... washable cover, fits
interior or exterior doors. Just slide on!
36"L x 6"W x 1-3/8"H

ADJ.
Climaloc.



CF10565 White
2 piece 36" vinyl adjustable door sweep, 3/4" to
1-1/2" "U" shaped w/fins, adjustable

ADJ.
Climaloc.



CF10576 White
2 piece 36" vinyl adjustable door sweep, 1-3/4"
to 2-1/2" "U" shaped for wood and metal doors
w/fins adjustable

Climaloc.



CI12781 42" x 64"
CI12782 80" x 86"
CI12783 64" x 210"
CI12295 84" x 25' (ft)
Shrink Window Kits Install with a Hair Dryer

H.D.
Climaloc.



CI22295 84" x 110"
Premium 0.9mm thick Insulating Kit. Shrinks
Crystal Clear. c/w double sided tape 195'.

Climaloc.



CR10050 1/2" x 5" x 36 1/2"
CR10044 1/4" x 4" x 36 1/2"
Aluminum commercial door thresholds.



CF20740 Silver
CF20745 White
 RCR Anodized aluminum and rubber door set, 2 x 82", 1 x 36" includes 2 corner seals



CF10070 Silver
CF10075 White
CF10074 Brown
 RCR Vinyl Climaloc door set weatherstripping, 2 x 82", 1 x 36", screws incl.



CF10694 Brown
CF10695 White
 RCR Climaloc weatherstripping door set, vinyl spring action, incl. 2 x 82", 1 x 36", screws incl.



CF20834 Brown
CF20835 White
 RCR Comfort Plus weatherstrip door set Climafoam on PVC frame with fascia plate, 2 x 82", 1 x 36", incl. screws and 2 corner seals



CF20844 Brown
CF20845 White
 RCR Comfort Plus weatherstrip door set Climafoam on aluminum frame with fascia plate, 2 x 82", 1 x 36", incl. screws and 2 corner seals



CF20734 Brown
CF20735 White
 2 x 82" & 1 x 36" set
CF65810 Brown
CF65811 White
 82" Bulk/ea.
 Climafoam replacement foam



CF20824 Brown
CF20825 White
 Magnetic composite polymer for metal door. incl. screws and 2 corner seals. 2 x 81" & 1 x 37"

Window Insulation Foam Tapes



Open Cell	Size	Color
CF12001	3/16" x 3/8" x 16.4'	White
CF12003	3/16" x 1/2" x 16.4'	White
Closed Cell	Size	Color
CF12005	3/16" x 3/8" x 16.4'	White
CF12010	3/16" x 3/8" x 40'	White
CF12011	1/4" x 3/8" x 9.8'	White
CF12012	1/4" x 3/8" x 29.5'	White
CF12013	1/4" x 3/4" x 9.8'	White
CF12014	1/2" x 1" x 15'	White
CF12006	3/16" x 3/8" x 16.4'	Black
CF12007	1/4" x 3/8" x 9.8'	Black
CF12015	1/2" x 1" x 15'	Black



Part#	Actual Size	Nominal ID	O.D.	Nesting Size
58CT	5/8"	1/2"	5/8"	1-5/8"
78CT	7/8"	3/4"	7/8"	2"
118CT	1-1/8"	1"	1-1/8"	2-1/8"
158CT	1-5/8"	1-1/2"	1-1/4"	2-5/8"

Pipe Insulation Extruded Foam reduces heat loss & condensation. Pre-slit, slips over existing pipes. Saves energy. 6ft length



CFSMOKE
 Draft Detector. For testing air drafts, smoke detectors, air flow patterns, fireplaces & chimneys. Approx 30min of use. Perfect to check for heat loss!



CF12081 3/8" x 30'
CF12082 1/2" x 25'
CF12083 5/8" x 20'
CF12084 3/4" x 15'
CF12086 1" x 10'
 Backer Rod. Simply fill the cracks and caulk! Grey color.



CF12748 White
 V-weatherstrip 16.4' x 7/8". Self-adhesive



CF24020 2"x12'
 EPDM Pipe and Duct Insulation Wrap. 1/8" thick, vinyl faced. -30C to 100C, indoor/outdoor. heating, A/C refrigeration & plumbing.



Super Seal Expanding Foam Tape



PSID144 1/4" to 1"
 Expanding Foam Tape. Self-adhesive to all surfaces. Expands gradually to fill seams and joints. Super Seal. 1"W x 13.1'L



CF12107
 Electric outlet (8 pieces) and switchplate (2 pieces) weatherstripping.

Entry Locksets - Grade 2

Fully compatible with Schlage, Baldwin and Dexter. Matches Schlage 'C' keyway. Fits Doors: 1 3/8" - 1 3/4" (35mm to 45mm) thick. Bore Holes: Cylinder hole 2 1/8" (54mm) - latch hole 1" (25mm) Backset: 2 3/4" standard; 2 3/8", 3 3/4", & 5" are available. Strike: "T" Strike Handing: Fits right-hand & left hand doors.

FEATURES:

C-UL & UL listed, 3 Hour fire rated, Meets or exceeds requirements of BHMA/ANSI A 156.2 series 4000 Grade 1, In compliance with C.G.S.B. standards. Supplied with ASA strike-standard, Thru-bolted, Clutch mechanism on all locking functions.



York - 8700/8900 Series Schlage C Keyway Satin Stainless Steel (C32D)

Part#	Type
32-8910	Passage
32-8940	Privacy
32-8953	Entrance (Keyed)
32-8980	Storeroom/Exit
32-8993	Dummy
32-8970	Classroom



Duke - 7900 Series Schlage C Keyway Satin Chrome (C26D), 5" Lever Len.

Part#	Type
32-7910	Passage
32-7940	Privacy
32-7953	Entrance (Keyed)
32-7980	Storeroom/Exit
32-7993	Dummy
32-7970	Classroom



Excalibur - Series Schlage C Keyway Satin Chrome (C26D), 4-1/2" Lever Len.

Part#	Type
32-4910	Passage
32-4940	Privacy
32-4953	Entrance (Keyed)
32-4980	Storeroom/Exit
32-4970	Classroom



Citadel - Series Schlage C Keyway Satin Chrome (C26D), 5-3/64" Lever Len.

Part#	Type
32-5510C26D	Passage
32-5540C26D	Privacy
32-5553C26D	Entrance (Keyed)
32-5580C26D	Storeroom/Exit
32-5570C26D	Classroom

32 Series - Grade 2

York - 8700/8900 Series
32-F470 Satin Chrome (C26D)
32-F450 S. Steel (C32D)



We carry **100's of Tools** to help with any installation projects!

Visit us online!

www.amresupply.com



PUSH PLATES & PULLS

Pre Drilled & Counter Sunk, screws included, 0.50 gauge. Suitable for metal or wood doors

Rounded handle w/plate

PART#	PULL	PLATE
H1411C28	7"	15"
H1410C28	9"	16"

Pull Handle Only

Thru Bolts & Grommets Included

SATIN ALUM.	SIZE
25-4007	7" Centers
25-4009	9" Centers

Plate Only

SATIN ALUM	SIZE.
25-4115	3-1/2" x 15"
25-416	4 x 16"



8000 SERIES - Push Bar Panic Exit Device



17-8536AL



17-8536VAL

PART#	SIZE
17-8536AL	Interior Push Bar 28-36" Door
17-F8536AL	Fire Rated

Vertical Rod

17-8536VAL	Fire Rated
17-F8536VAL	Fire Rated

For doors from 28"x84" to 36"x96"

FEATURES:

UL and C-UL listed. Meets or exceeds requirements of ANSI 156.3 - GR.2. In compliance with C.G.S.B. standards. Narrow profile pushpad. Non-handed (reversible). Minimum style width - 4 1/4". Suits doors up to 1 3/4" thick. Accepts standard cylinders [diameter 1 3/16"]. Deadlocking side latch with full 3/4" throw -stainless steel (Pullman type). Dark bronze & polished brass available, special order.

900 SERIES - Pushbar Panic Exit Device - Aluminium Finish



R.H. PART#	L.H. PART#
17-900ALRR	17-900ALLR
Exit only, no building acc. on ext. doors, c/w 38" bar	
17-950ALRR	17-950ALLR
Exterior access by key & thumb latch, c/w 38" bar	
17-SS800AAL	Cylinder "C" Schlage keyway

FEATURES:

C-UL & UL listed for safety (not fire rated). Reversible for RHR or LHR, Dogging function standard, Heavy Duty, 4 Outside trims available, Accepts standard North American cylinders, Suits doors up to 2" (51mm) thick, Roller strike included, Standard Cross bar 38" (97cm), Chrome plated steel 48" (122cm) bar available, *Cylinders not included

4590 Deadlatch Paddle

An alternative to knob or lever handles. Available for any Adams Rite Series 4500 or 4700 deadlatch (except 4750) or MS+1890 lock/latch. 1-3/4" door thickness. Satin Aluminium



Adams Rite A.G.P. Hand
4590-02-00-628 **11-2020L** PUSH TO LEFT
 Outside of left hand door or inside of right hand reverse.

4590-04-00-628 **11-2020R** PUSH TO RIGHT
 Outside of right hand door or inside of left hand reverse.
Cam can be ordered separately, use part # 4580 (11-2015C)

861B-26D-41 (CG3XCAD)
 Cylinder guard ring, fits all standard mortise cylinders, silver finish



4580 (11-2015C)
 Adams Rite cam disk, used with 4560/4651/4565 handles.



4560/4565 Deadlatch Handles

Can be reversed by removing a spring clip, "flopping" the cam and replacing the clip.
4560-Long standard length
4565-Ideal for doors where latch is operated infrequently or in emergencies only.
 1-3/4 - 2" door thickness

Part#	Hand	Finish	Handle
11-2015-RH	RH or RHR	Satin Chrome	3-3/4"
11-2015-LH	LH or LHR	Satin Chrome	3-3/4"
4560-601-121	RH or RHR	Bronze	3-3/4"
4560-501-121	LH or LHR	Bronze	3-3/4"
4565-601-628	RH / RHR / LH / LHR	Satin Chrome	1-1/2"

Cam can be ordered separately, use part # 4580 (11-2015C)



All Models can be reversed



Mortise Cylinders/Thumbturns/Blanks

Solid Brass Construction, in brushed chrome finish, all these cylinders come with cam to operate "Adams Rite" or Adams Rite alike Deadlatches and Dead bolts. If you have other brands like Corbin, Sargent, Schalgel "L" series or Yale standard, different cams are required. These cylinders are available upon request, but are special order.



Part#	Type	Image	Keyway	A	Pins
M100-D-26D-AR	Blank	A	none	1"	NA
M118D-26D-AR	Blank	A	none	1-1/8"	NA
M100-SC-26D-AR	Keyed	B	Schlage C	1"	5
M118-SC-26D-AR	Keyed	B	Schlage C	1-1/8"	6
M118-SCE-26D-AR	Keyed	B	Schlage E	1-1/8"	6
M118-SCF-26D-AR	Keyed	B	Schlage F	1-1/8"	6
M100-WR-26D-AR	Keyed	B	Weiser	1"	5
M118-WR-26D-AR	Keyed	B	Weiser	1-1/8"	6
M100-T-26D-AR	Thumbturn	C	none	1"	NA
M118T-26D-AR	Thumbturn	C	none	1-1/8"	NA

Other Keyways available, special order, please call us for part number and price. All keyed cylinders come with 2 keys.



7102-26D-41 Satin Chr.
7102-03-41 Bright Brass
 Kaba Simplex 7100 Series Deadbolt Pushbutton Lock.
 Pushbutton exterior access, thumbturn egress by interior, manual relock.
 - 1-3/8" to 2-1/4" door thickness
 - Reversible handing
 - Min 4" stile for mounting
 - 2-3/4" backset
 - 1" tubular deadbolt, flat faceplate



1011-26D-41 Knob
1021S-26D-41 Knob w/Key Override (Schlage req. core sold sep.)
LL1011-26D-41 Lever
LL1021S-26D-41 Lever w/Key Override (Schlage req. core sold sep.)
23030C-626 Schlage 6pin "C" Core
 Kaba Simplex 1000 Series Pushbutton Locks.
 Exterior access by combination, egress by interior knob/lever. 1021S model includes key override for access. Set to accept Schlage core sold separate
 - 1-3/8" to 2-1/4" door thickness
 - Set for LH door but are reversible
 - 2-3/4" backset
 - Min 5" stile for mounting
 - 26D Satin Chrome Finish

1011-26D-41

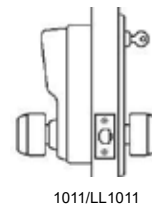

1011/LL1011

LL1011-26D-41

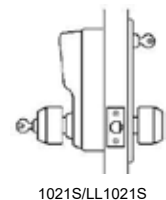

1021S/LL1021S





MS1850S Deadbolt for Metal Stile Glass Doors Grade 1

Key can be removed only when bolt is in a positively locked or unlocked position. Lock accepts any standard 1-5/32" diameter mortise cylinder or thumbturn from either or both sides. Cylinder must have MS dimensioned cam. Latch bolt is 5/8" X 1-3/8" X 2-7/8" with 1-3/8" throw. Cutout 6.885" x 1.01"

Part#	Backset	Cutout	Faceplate Finish
MS1850S-210-628	31/32"	6.885" X 1.010"	Satin Alum
MS1850S-310-628	1-1/8"	6.885" X 1.010"	Satin Alum
MS1853S-110-628	7/8"	6.885" X 1.010"	Less Faceplate
MS1853S-410-628	1-1/2"	6.885" X 1.010"	Less Faceplate

Faceplates available separately, 628 Satin Aluminium Finish:
24-0384-110-628 Radius for Dual Door Strike
24-0384-010-628 Flat for Jamb Strikes

Deadlatch for Narrow Metal Stile Glass Doors Grade 1

Uses any standard mortise cylinder with MS cam. Latch Bolt is 1/2" X 1" X 1/2" throw. All metal with hardened steel internal pins. Handing is easily reversible. Strikes sold separately see **4502**. Cutout 6.885" x 1.01"

Part#	Hand	Backset (A)
DL2412-2AL	LH	31/32"
DL2422-2AL	RH	31/32"
DL2413-2AL	LH	1-1/8"
DL2423-2AL	RH	1-1/8"
8516	LH/RH	7/8"
11-2002D	LH/RH	1-1/2"

Faceplates available separately, 628 Satin Aluminium Finish:
24-0017-1220-628 Radius for Dual Door Strike
24-0017-0220-628 Flat for Jamb Strikes

15CA Series

Grade 2 Electric Locks

RCI's 15CA series electric strikes. ANSI-size faceplate (1-1/4" x 5-7/8"). Compatible with cylindrical locksets. Brushed anodized aluminium faceplate. Door thickness 1-3/8" - 2-3/8". Fits most aluminium door frame depths. Fully reversible LH or RH. 5/8" latch, 1-1/2" c-c cutout, mount proj. 4-1/8". Fail = locked.

15CA-01-28 3-6Vdc, 8-16Vac
 Note* 15CA models are rated for continuous duty, 1 min. or more at DC voltage, sound is silent, rated for intermittent use with AC voltage, sound is buzz.



710-16 8-24AC/8-16DC
710-24 16-24AC/16-24DC

PESO Electric Strikes
 Tough zinc alloy strike latch, metal frame appl., 5/32" (4.0 mm) horizontal adj. after installation. Latch projection up to 5/8", non-handed, metallic silver, Electrical mode: "Fail-Secure (fail-locked)" Buzz sound occurs only if AC current is used. 1-5/32"W x 5-29/32"H. 5-5/16" centers



7104-05D-32D 12V DC
7104-08D-32D 24V DC

RCI Electric Door Strikes 7 Series
 Centerline adj. latch entry for Alum. door frames, non handed, stainless steel plate, 1-1/4"W x 4-7/8"H ANSI, fail unlocked, silent using DC currents, 1/8" Horizontal adj. 1-1/2" cut-out depth for most alum. and wood frames, use with wide range of door thicknesses (1-3/8" to 2-3/8")



4104-05-32D 12V AC/DC
4104-08-32D 24V AC/DC

RCI Electric Door Strikes 4 Series
 Centerline latch entry for Alum. door frames, non handed, stainless steel plate, 1-1/4"W x 4-7/8"H ANSI, fail locked, silent using DC currents, Accommodates 3/4" latch projection (pullman design not included), Use with wide range of door thicknesses (1-3/8" to 2-3/8")



7108-05D-32D 12V DC
7108-08D-32D 24V DC

RCI Electric Door Strikes 7 Series
 Centerline adj. latch entry for Alum. door frames, non-handed, stainless steel plate, 1-7/16"W x 7-15/16"H ANSI, fail unlocked, silent using DC currents, 1/8" Horizontal adj. 1-1/2" cut-out depth for most alum. and wood frames Use with wide range of door thicknesses (1-3/8" to 2-3/8")



4304-09-32D 24V DC
RCI Electric Door Strikes 4 Series
 Centerline latch entry for Aluminium Door Frames, non handed, stainless steel plate, 1-1/4"W x 4-7/8"H ANSI, fail unlocked, silent using DC currents, Accommodates 3/4" latch projection, (pullman design not included), Use with wide range of door thicknesses (1-3/8" to 2-3/8")



J4551 Silver 4"
J4552 Bronze 4"
25-4650SR Silver 5"
 Traditional Styling, more suited for Commercial environments. C/W Rubber Foot

MORE door stops on page 291

289-C26D Satin Chr, 5" brass
289-C3 Brass, 5" brass
J4523 Chr, 4" cast
J4533 Brz, 4" cast
J4543 Brass, 4" cast
 Modern Styling, Commercial Grade Door Holders
289-REP Repl. foot only, 289 series



J4602 Br. Chrome
 Floor Mounted Door Stop & Holder. 3-3/8"H, 2-1/8"Dia Base. Brass construction.



J4592
 Floor Stop
 Wrought steel with soft resilient rubber bumper, used on undercut doors up to 1-1/2".



25-R4650T Black - threaded
25-R4649T Grey - screw-in
 Replacement Foot, slip-on



J4596 Pol. Brass
 Wall Door Stop. 3-5/8"L, 2-1/4"Dia Base. Cast brass construction.



J4547 Br. Chrome
 Floor Stop, 3-1/4" Tall, Brass. Cast brass door bumper with rubber; brushed chrome finish; mounts to floor. Meets ANSI standards.



J4595
 Step-on door holder, Aluminium painted diecast, Spring loaded. Die cast zinc step on door holder



11-1549L Left Hand
11-1549R Right Hand
 Replacement pivots for Vistawall style commercial doors. Aluminium Finish, Bronze available Includes Top And Bottom Door Portions And Top And Bottom Frame Portions



11-1653L Left Hand
11-1653R Right Hand
 Aluminex/Jackson Commercial Offset Pivot Set (4 pcs.) Aluminium finish



11-1775L Left Hand
11-1775R Right Hand
 Top & Bottom 3/4" Offset Pivot Set (200 LBS)



11-1625L Left Hand
11-1625R Right Hand
 This commercial door pivot set includes all parts needed to replace a Kawneer® brand pivot system:
 - Top Door Portion
 - Bottom Door Portion
 - Top Frame Portion
 - Bottom Frame Portion (only handed portion)



11-1550L Left Hand
11-1550R Right Hand
 This Commercial Door Pivot is made of die cast and is designed to fit on Commercial Aluminium commercial doors. Pivots are sold in complete sets only. Left Hand Shown.

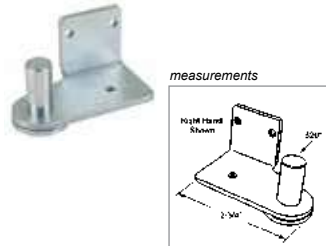

11-1502L Left Hand
11-1502R Right Hand
 Commercial Door Pivot - Bottom Frame Portion
 Right Hand Shown.



11-1545L Left Hand
11-1545R Right Hand
 Amarlite Door Pivots for commercial doors. Aluminium Finish, Bronze available Includes Top And Bottom Door Portions And Top And Bottom Frame Portions 3/4" offset pivots for aluminium doors and frames For flush door / frame and 1/8" recessed door applications Weather resistant

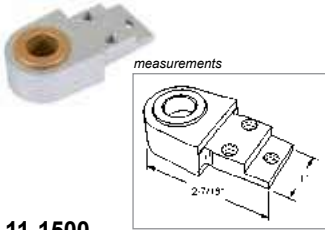

11-1500
 Zimmcor Aluminium Top Frame Portion

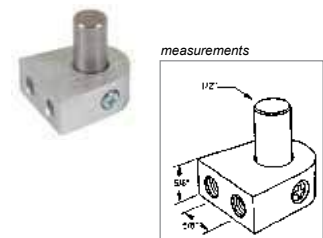

11-1501
 Zimmcor Aluminium Top Door Portion

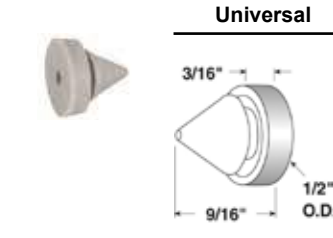

J4566
 Door Mute



11-1613 DC860G
 Flush Bolt Guides, fits DC840C15/11-1604

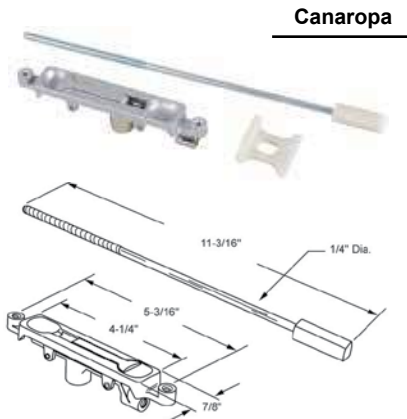

11-1604 Satin Aluminium
11-1604B Bronze
 Single Standard Flush Bolt with rod, 12", nylon tip and guide for aluminium doors

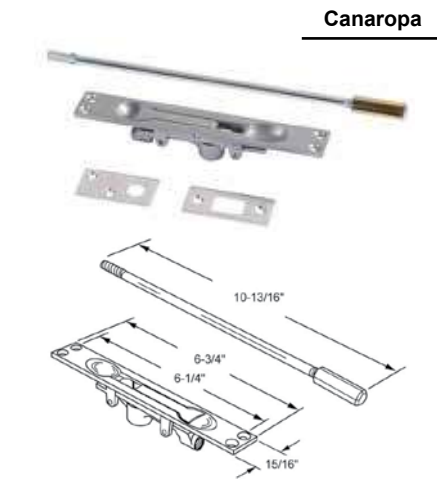

11-1801 Nickel
 Single Flush Bolt with rod, 12", tip and keeper for Steel/Wood Doors

DO MORE
 Amre can supply you with any commercial door hardware
 Contact our sales dept. or check out our website!
www.amresupply.com



KC10HD White
Safety spring door closer. Surface mounted. Works on doors up to 150 lbs. Non-handed. Adjustable tension. U.L. listed. 1/2 hour fire rated. Diecast.



Do-it-yourself Video Library

100's of repair videos are now online!
Search for help on repairs & installations.

www.amresupply.com

1900 SERIES - GRADE 1

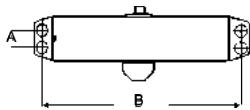

Standard Function Power Adjustable

FEATURES:

UL and C-UL Listed (Fire Rated), 10 Year Guarantee, Power Adjustable, Standard and Medium Duty Commercial Application. Adjustable Back Check Standard. Universal Mounting (Reg. & Parallel brackets included). High Strength pressure cast aluminium housing, full metal Cover and optional delayed action & Barrier free



GRADE 1

1900 Series - Aluminium

PART#	A	B	DOOR SIZE	DOOR WEIGHT
13-1900AL	1-1/8"	11-1/8"	48" X 96" (121cm X 243cm) Adj., Power 2, to 6 w/Backcheck	266lbs/121kg
13-1900BFDAAL	1-1/8"	11-1/8"	48" X 96" (121cm X 240cm) Adj., Power 1, to 4 w/Backcheck, Barrier Free & Delayed Action	266lbs/121kg

550 SERIES - GRADE 3

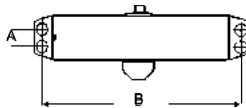
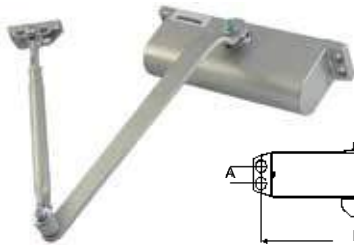

FEATURES:

- UL & C-UL Listed (Fire Rated)
- 5 Yr. Guarantee
- In compliance with C.G.S.B. Standards
- Residential & standard duty commercial application
- Dual valve adjust (closing & latching speed)
- Reversible for both right & left hand doors
- Universal mounting (regular & parallel brackets included)

GRADE 3

550 Series - Aluminium

PART#	A	B	DOOR SIZE	DOOR WEIGHT
13-552APAL	3/4"	8 3/16"	36" X 84" (90cm X 210cm)	55-100lbs. (25-45kg)
13-553APAL	3/4"	8 3/16"	38" X 84" (95cm X 210cm)	88-143lbs. (40-69kg)
13-554APAL	3/4"	9 3/16"	42" X 96" (105cm X 240cm)	132-187lbs. (60-84kg)

*Tri-pack-Each door closer supplied "A" arm standard; and each carton includes "P" (Parallel arm) bracket so any closer can be mounted three ways: Regular arm; Parallel arm; or Top Jamb Mount.
*Duronotic Bronze Finish Available, Special Order Only.

600/690 SERIES - GRADE 3

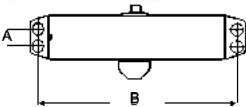
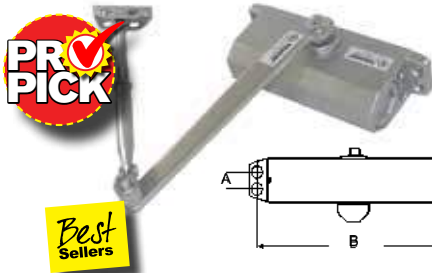

FEATURES:

UL & C-UL Listed (Fire Rated). 5 Yr. Guarantee. High strength pressure cast aluminium housing. Full rack & pinion mechanism. Dual valve adjust (closing & latching speed) and reversible for both right & left hand doors

GRADE 3

600 Series - Aluminium

PART#	A	B	DOOR SIZE	DOOR WEIGHT
14-602AAL	3/4"	6 5/8"	36" X 84" (90cm X 210cm)	55-100lbs. (25-45kg)
14-603AAL	3/4"	8 1/8"	38" X 84" (95cm X 210cm)	88-143lbs. (40-64kg)
14-604AAL	3/4"	9 1/32"	36" X 108" (105cm X 240cm)	132-188lbs. (60-85kg)

Available in Bronze Finish, substitute "DB": for "AL"

690 SERIES - GRADE 3

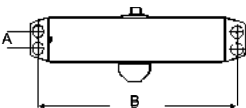
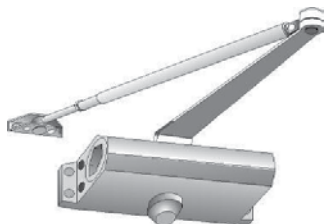

Backcheck Function (Storefront)

FEATURES:

U.L. & C.-U.-L. Listed (Fire Rated). 5 Year Guarantee. High Strength Pressure Cast Aluminium Housing. Full Rack & Pinion Mechanism. Heat Treated High Tensile One Piece Piston and Spindle. Two Separate Speed Regulating Valves to Control Closing and Latching Speed. Reversible for both right and left hand doors. Leak Proof "O"-Rings Oil Seal. Adjustable Arm for all Models. "A" Arm supplied standard, complete w/optional parallel arm bracket

GRADE 3

690 Series (Backcheck Function) - Aluminium

PART#	A	B	DOOR SIZE	DOOR WEIGHT
14-693AL	3/4"	8 1/8"	38" X 84" (95cm X 210cm)	88-144lbs. (40-65kg)
14-694AL	3/4"	9 1/32"	42" X 96" (105cm X 240cm)	144-220lbs. (65-100kg)
14-695AL	3/4"	9 1/32"	42" X 96" (105cm X 240cm)	187-265lbs. (85-120kg)

Available in Bronze Finish, substitute "DB": for "AL"



Job Quotes Available

Easy application for installing your house address

New!



Klassen 2" Metal Adhesive house numbers and letters. Available in #'s 0-9 and letters A-Z

AMRE has all the signs you need for identification and safety

Take a look online www.amresupply.com



Modern Style - Solid Brass

Size	Satin Nickel
3"	27-MSN3(?)
4"	27-MSN4(?)
6"	27-MSN6(?)

Note: (?) this symbol is where you indicate which number you are looking for.



Heritage Style - Solid Brass

Size	Pol. Brass(L.F)*	Pol. Brass	Aged Bronze
4"	25-ATN4(?)	27-BRS4(?)	27-ORB4(?)
6"	-	27-BRS6(?)	27-ORB6(?)

*Lifetime Finish
Note: (?) this symbol is where you indicate which number you are looking for.



Heritage Style - Aluminium

Size	Black	White	Brsh. Alum.
4"	25-ANB4(?)	-	25-ANC4(?)
6"	25-ANB6(?)	25-ANW6(?)	25-ANC6(?)

Note: (?) this symbol is where you indicate which number you are looking for.



628B 16"
Support Cap (5/8")
Use to cover the sawn edge of the shelf. Choose cap according to board width and thickness.



629V 12"
631V 16"
Shelf Support
Use to attach a shelf to the wall of a closet or the side of a wooden partition. The support will mount into drywall or wood.



630V 12"
632V 16"
Shelf & Rod Support
Use to attach a shelf and rod to the wall of a closet or the side of a wooden partition. Mounts into drywall or wood.



633V
Centre Shelf & Rod Support
Use as a mid-span support when a shelf & rod are present. Will work with either 12" or 16" board width. Use every 36" to 48" or as required.



634
Centre Shelf Support
Use as a mid-span support when only a shelf is present. Will work with either 12" or 16" board width. Use every 36" to 48" or as required.



Acme White
Wall Bracket, side support
4822-012 12" (pr.)
4822-016 16" (pr.)



Center Brace
4823-012 12"
4823-016 16"



650V 1" Dia.
25-2820 1-3/8" Dia.
Closet Rod Sockets



498WIBC Adjustable
Shelf Support For Shelf 14" Wide, a Rod Up To 1 1/2" Dia., Ivory Enamelled Shelf & Rod Support







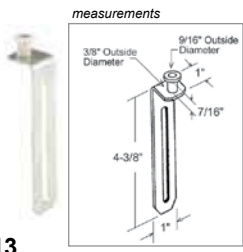

Length	Part#
18" - 30"	25-MR1830
30" - 48"	25-MR3048
48" - 72"	25-MR4872
72" - 96"	25-MR7296
96" - 120"	25-MR96120
Adjustable Closet Rods	

Part#
White
25-MR1830W
25-MR3048W
25-MR4872W
25-MR7296W

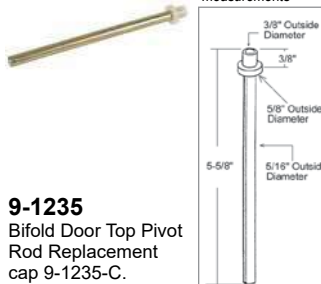

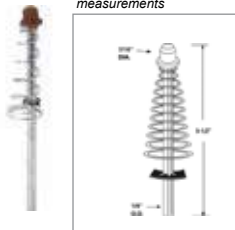
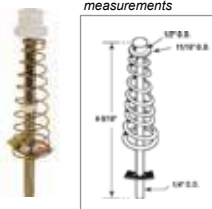
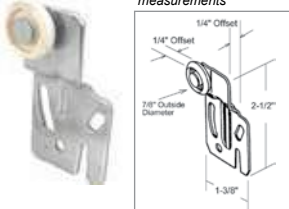
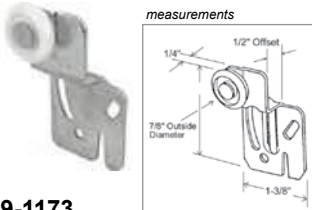
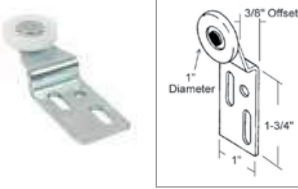
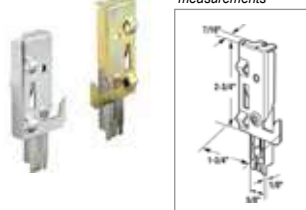
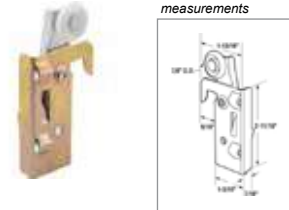
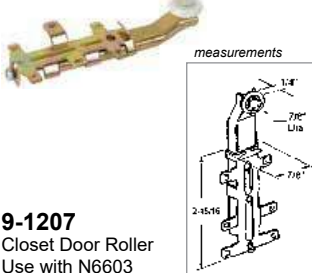
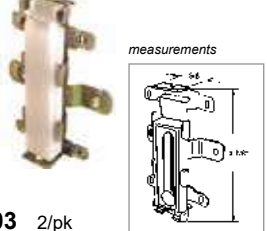
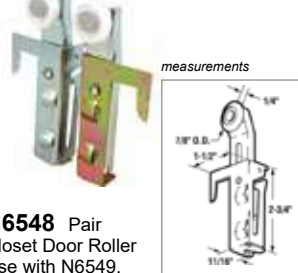
 <p>N6546 2/pk Closet Door Bottom Pivot Pivot bracket separate, 9-1115.</p>	 <p>N6696 2/pk Closet Door Bottom Pivot Bracket separate, 9-1108.</p>	 <p>N6545 2/pk Closet Door Top Pivot Pivot pin cap separate, 9-1106B</p>	 <p>9-1225 Bifold Door Top Pivot</p>
 <p>9-1226 Bifold Door Pivot and Guide</p>	 <p>9-1123 Closet Door Pivot</p>	 <p>N6582 2/pk Closet Door Guide Roller</p>	 <p>9-1135 2/pk Closet Door Top Pivot Pin.</p>
 <p>9-1121 Closet Door Guide Roller</p>	 <p>9-1228 Bifold Door Top Pivot and Guide</p>	 <p>MP6539 2/pk Closet Door Track Snugger</p>	 <p>9-1155 Pivot Pin Cap</p>
 <p>9-1122 Bi-Fold Door Top Guide</p>	 <p>9-1286 Bifold Door Rod Guide</p>	 <p>N7191 1-1/8"W - 2/pk N7192 1-3/8"W - 2/pk N7216 31/32"W - 2/pk Closet Door Repair Bracket. reinforces pivot hole.</p>	 <p>N6606 2/pk Closet Door Top Pivot Bracket</p>
 <p>N6674 Closet Door Bottom Pivot Bracket Used with pivot N6696.</p>	 <p>9-1115 Closet Door Bottom Pivot Bracket Use with pivot N6546.</p>	 <p>N6560 2/pk Closet Door Bottom Guide</p>	 <p>MP6563-4 4/pk Closet Door Guide</p>
 <p>9-1160 Bifold Door Bottom Pivot Clamp For bi-fold door pins.</p>	 <p>9-1296 Bifold Door Top Pivot Pin</p>	 <p>9-1118 Closet Door Roller</p>	 <p>73011V Closet Door Top Pivot</p>

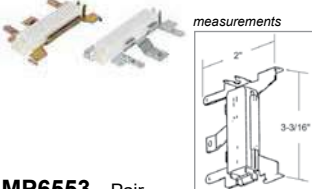
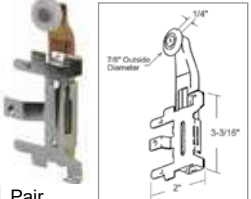
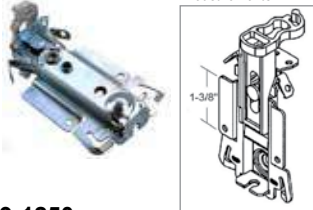
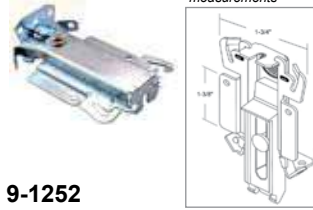

 <p>9-1112 Bi-Fold Bottom Guide</p>	 <p>9-1113 Bifold Top Guide</p>	 <p>9-1117 Closet Door Pivot</p>	 <p>9-1235 Bifold Door Top Pivot Rod Replacement cap 9-1235-C.</p>
 <p>N6637 Closet Door Pivot (6-3/8" Long)</p>	 <p>9-1145 Bifold Door Guide Rod</p>	 <p>N6769 Bifold Door Guide Rod</p>	 <p>9-1161 Closet Door Roller - Front, 1/4" offset Use with 9-1173</p>
 <p>9-1173 Closet Door Roller - Back, 1/2" offset Use with 9-1161</p>	 <p>9-1277 3/8" Offset Closet Door Roller</p>	 <p>N7047 Closet Door Guides Pair 1 left, 1 right, use with N7046</p>	 <p>N7046 Closet Door Rollers Pair: 1 left, 1 right Use with N7047</p>
 <p>9-1207 Closet Door Roller Use with N6603</p>	 <p>N6603 2/pk Closet Door Guide Plastic Guide, use with 9-1207</p>	 <p>N6548 Pair Closet Door Roller Use with N6549.</p>	 <p>N6549 Pair Closet Door Guides Use with N6548</p>
 <p>MP6553 Pair Bottom Snap-In Closet Door Corners Use with 9-1131</p>	 <p>9-1131 Pair Top Hung Closet Door Rollers Use with MP6553</p>	 <p>9-1250 Bypass Top Guide, use with 9-1252</p>	 <p>9-1252 Bypass Bottom Guide Hole Mount 1-1/2", use with 9-1250</p>
 <p>N6551 Bottom Corner Bracket Guides Replacement guide, 9-1102-G, available separately. Use with N6550</p>	 <p>N6550 Top Hung Closet Door Rollers Use with N6551</p>		





C1043
W/O Keyed Cylinder, 6-5/8" centers

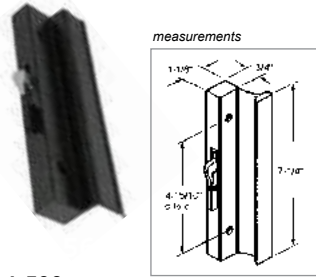

4-500
Black Plastic
4-15/16" centers x 7-1/4"L

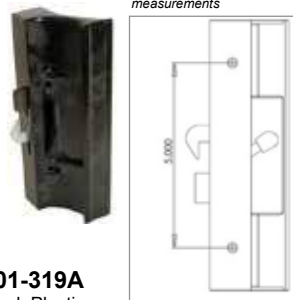

101-319A
Black Plastic
3-7/8" centers, 7.325"L

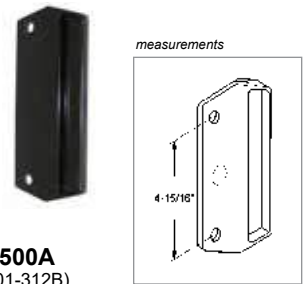

4-500A
(101-312B)
Black Plastic
4-15/16" centers x 2-11/16"L



4-5009W White
4-5009B Brown
Sliding Glass Door Handle Set.
Installation screws included.

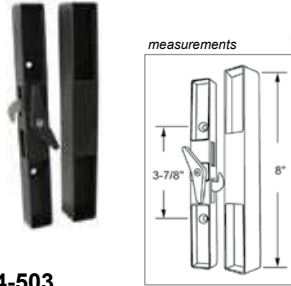
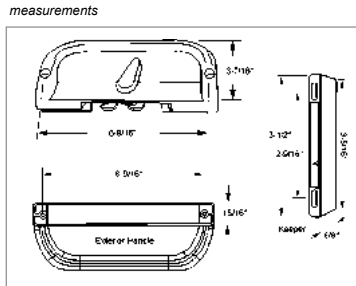

4-503
Black Plastic Handle
8"H, 3-7/8" centers



C1182
Wood & Black Sliding Glass Door Pull
6-5/8" centers

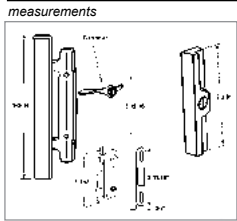

4-561W
Sliding Glass Door
Handle

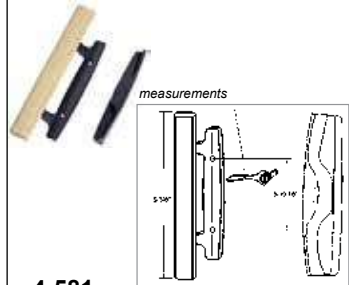

4-581
Sliding Glass Door wooden handle
Black painted die cast zinc

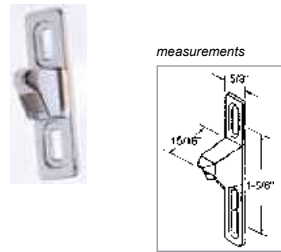

4-554A
Die Cast Shim Door Strike
5/8"W, 1-5/8" centers, 15/16" projection

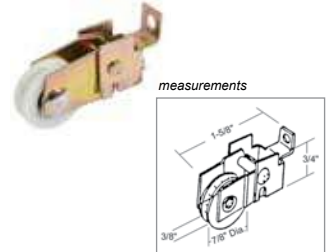

4-133
Nylon B.B. Wheel Steel Housing
1-5/8"H x 7/8"D roller

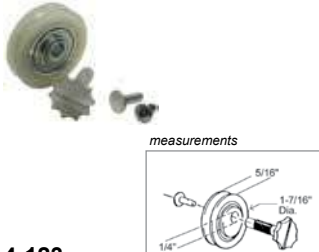

4-123
1 7/16" O.D. Nylon B.B. Wheel Off-Center Hole

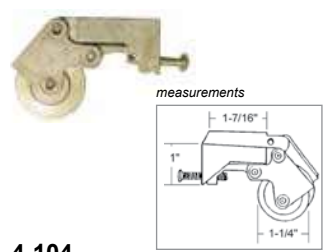

4-104
1 1/4" Die Cast Housing Steel B.B. Wheel

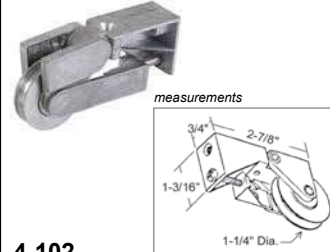

4-102
Sliding Glass Door Roller, 3/4" Wide,
Single Mounting Hole

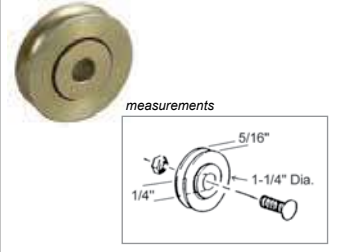

4-114
Sliding Glass Door Roller

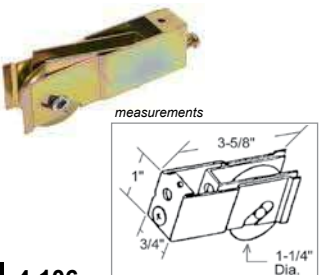

4-106
Sliding Glass Door Roller

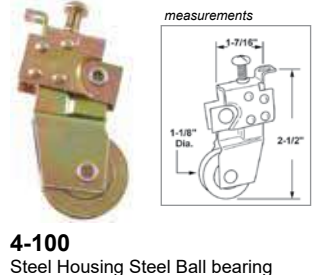

4-100
Steel Housing Steel Ball bearing
Wheel
2-1/2"H x 1-1/8"D x 9/16"W

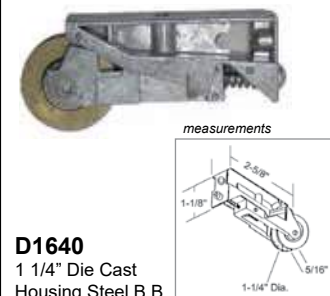

D1640
1 1/4" Die Cast
Housing Steel B.B.
Wheel

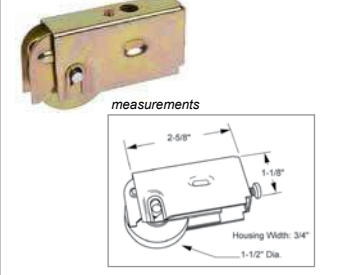

4-111
Sliding Glass Door Roller



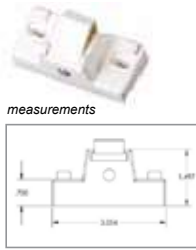

101-305WH
Foot activated sliding door lock. Secondary security lock. 3" Length



U9920 Silver
Patio door security bar. Adjustable length 28" to 48". Lockable in ventilating position.

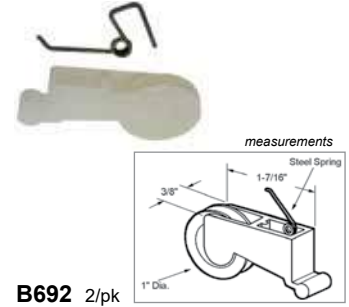

B692 2/pk
Plastic Wheel & Housing

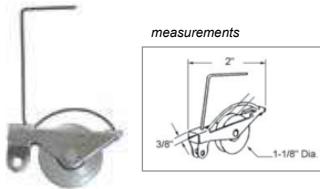

3-205
Steel Ball Bearing Wheel, 1/4" groove, 1-1/8" Dia.

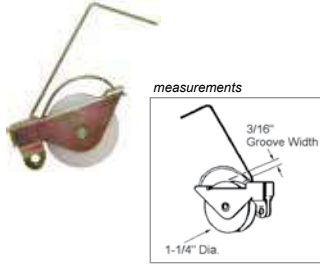

3-213
1 1/4" O.D. Nylon Wheel, 3/16" groove

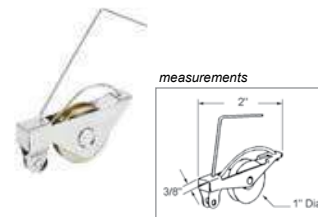

B541 St. ball bearing 2/pk
3-303-N Nylon each
Sliding Screen Door Rollers, 1" Dia.

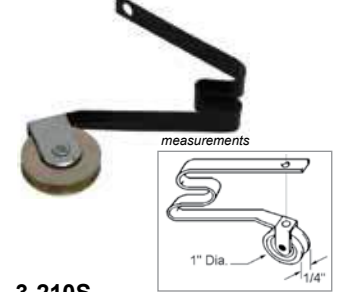

3-210S
1" O.D. Steel Ball Bearing

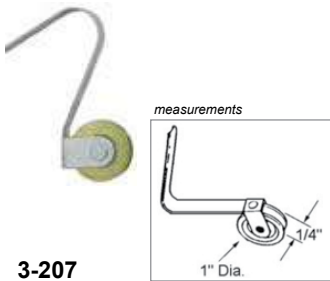

3-207
Steel Ball Bearing Wheel, 1/4" wheel width x 1" dia.

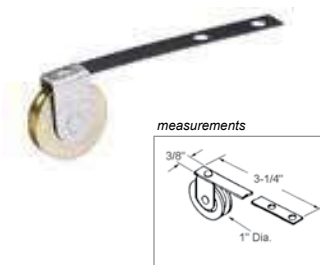

3-217
1" Steel Ball Bearing Wheel

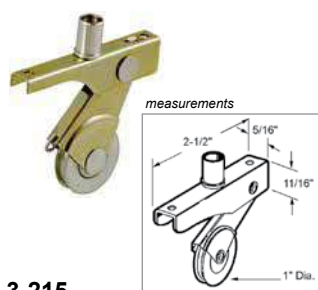

3-215
Sliding Screen Door Roller

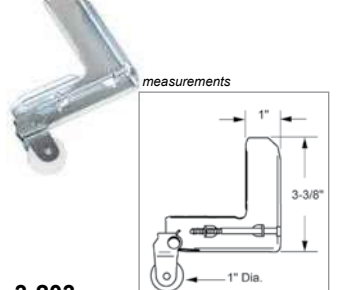

3-203
Sliding Screen Door Roller & Corner

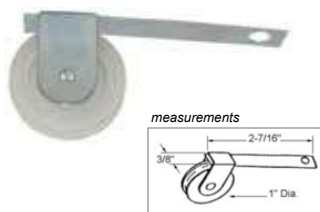

3-306
Sliding Screen Door Roller, plastic wheel, 1" dia.

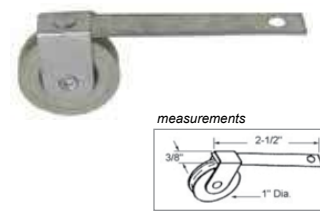

3-224
1" O.D. Steel Ball Bearing Wheel

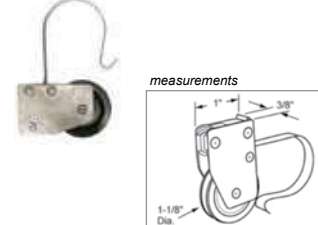

3-240
1 1/8" Dia. Plastic Wheel Use with #3-287 Corner

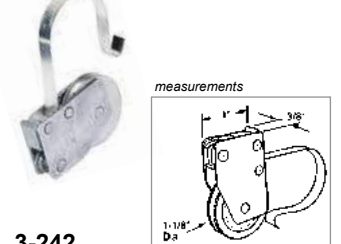

3-242
Sliding Screen Door Roller. Used with 3-287 corner. Steel wheel

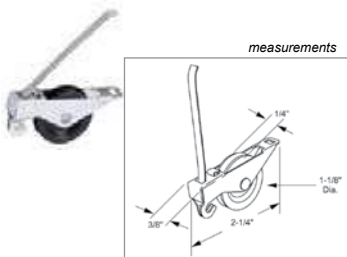

3-209
Sliding Screen Door Roller

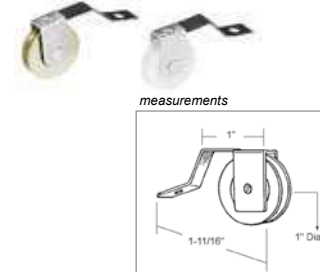

3-241 nylon roller
3-241S steel ball bearing
Sliding Screen Door Roller

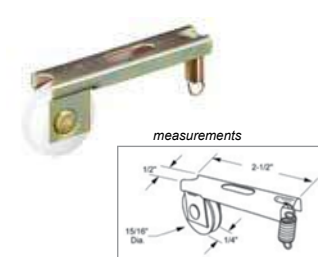

3-208
15/16" Plastic Wheel

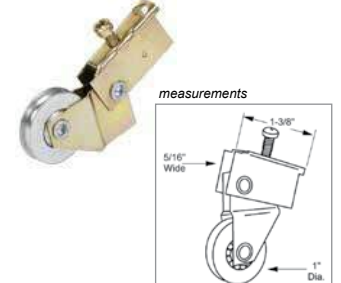

3-233
Sliding Screen Door Roller, steel w/ball bearing



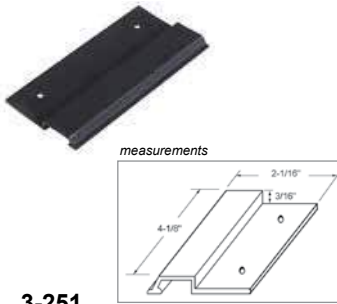

3-251
Sliding Screen Door Pull



3-253
Sliding Screen Door Pull



3-250
Sliding Screen Door Pull, Black Plastic



A-142
Sliding Screen Door Latch & Pull, 2-5/8", Plastic Housing, Black, Steel Latch

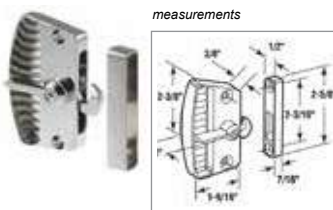

PL-A105
Sliding Screen Door Deluxe Latch & Pull, 2-3/8", Diecast, Chrome, Non-Handed



3-258
Sliding Screen Door Strike (9/32" Offset)

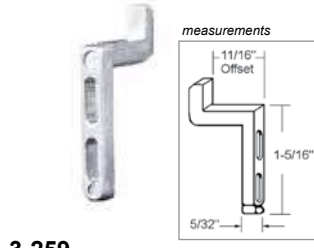

3-259
Sliding Screen Door Strike (11/16" Offset)

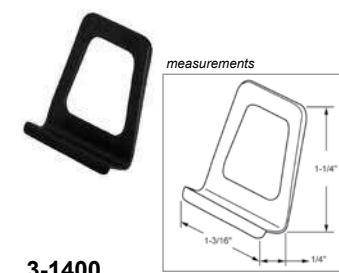

3-1400
Window Screen Pull - black

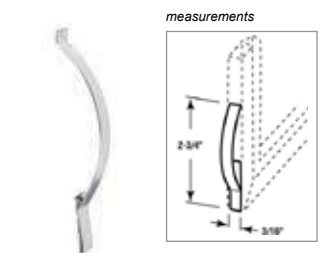

L5605 6/pk
Sliding Screen Door, Slip-In Tension Spring

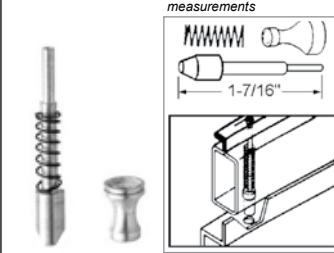

3-1407
Window Screen Plunger Latch

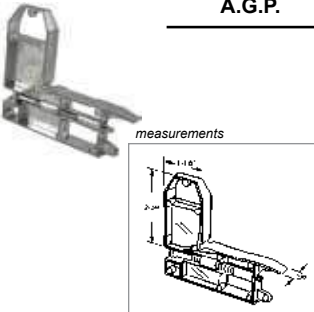

3-214
Bottom Sliding Screen Corner Bracket

A.G.P.

100's of parts online

Check out www.amresupply.com for a full selection of door and window hardware parts

Learn More

Door & Window Hardware > Sliding Screen Door Hardware

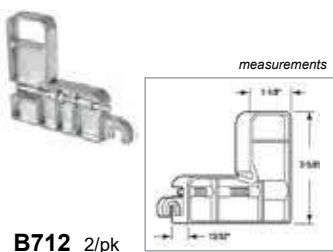

B712 2/pk
Sliding Screen Door Corner. Narrow style corner - die cast

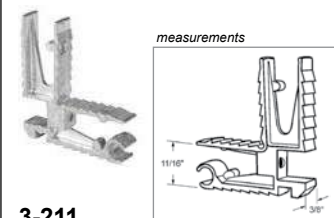

3-211
Sliding Screen Door Corner. Used with 3-202 sliding screen door roller. Die cast

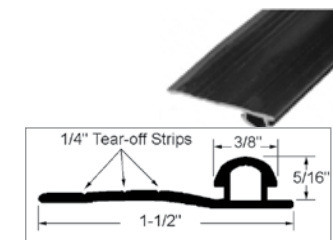

3-1459
Sliding Screen Door Bug Bar. Sold per foot. 5/16"W x 1-1/2"H



4-197-6
Bulb Sill Track Cover. 1/4"W x 6' long. Mill finish.

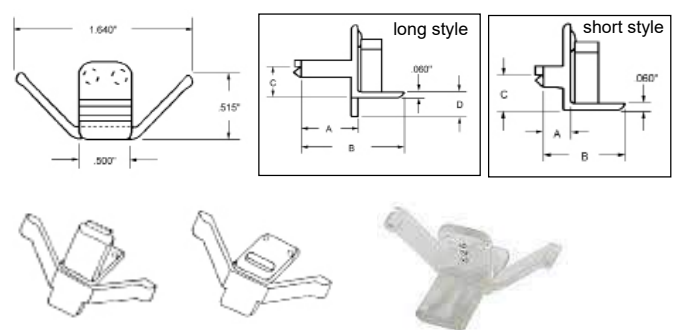

Screen Clips — Long Style				
Part#	A	B	C	D
3-1413	.670"	1.230"	.190"	N/A
3-1415	.760"	1.350"	.300"	.280"
3-1429	.910"	1.500"	.100"	N/A

Screen Clips — Short Style			
Part#	A	B	C
3-1404	.150"	.750"	.050"

Polycarbonate screen clips, Clear. Some sizes must be ordered in quantities of 100, please inquire before ordering.



Rolled Screen



- SG24100B** Black Fiberglass 24" X 100'
- SG30100B** Black Fiberglass 30" X 100'
- SG3625B** Black Fiberglass 36" x 25'
- SG36100B** Black Fiberglass 36" X 100'
- SG4825B** Black Fiberglass 48" x 25'
- SG48100B** Black Fiberglass 48" X 100'
- SG60100B** Black Fiberglass 60" X 100'
- SA36100S** Aluminium 36" X 100'
- SA48100S** Aluminium 48" X 100'

RCR screen rolls in black fiberglass or bright silver aluminium.



- SG2484B** Black Fiberglass 24" x 84"
- SG3084B** Black Fiberglass 30" x 84"
- SG3684B** Black Fiberglass 36" x 84"
- SG4884B** Black Fiberglass 48" x 84"
- SA2484S** Silver Aluminium 24" x 84"
- SA3084S** Silver Aluminium 30" x 84"
- SA3684S** Silver Aluminium 36" x 84"
- SA4884S** Silver Aluminium 48" x 84"

Pre-cut screening in black fiberglass or bright silver aluminium.



Still have tiny insects coming through your screen?



SM3684B 36" x 84"
RCR Micromesh screen is made of finer mesh fiberglass to keep very small insects out.



Screening Kits



- SG3684BK** 36" x 84"
- SG4884BK** 48" x 84"

RCR Screening kits. Includes black fiberglass screening, spline, installation tool and cutter.



- SFG3636WK** 36" x 36"
- SFG4848WK** 48" x 48"

RCR Screening kit with frame includes black fiberglass screening, spline, installation tool, cutter, 7/16" white screen frame that can be cut to size and 4 screen corners.



7X Stronger



- SP3684BK** 36" x 84"

RCR Pet resistant screening kit. Made from vinyl coated polyester it is much heavier and stronger than fiberglass or aluminium. Includes screening, spline, installation tool and cutter.



- SAW112036** 11"H x 20"-36"W

RCR Adjustable screen allows the placement of a screen where permanent ones won't fit. Easy to install, durable, lightweight and pile on top and bottom to assure snug fit.

Screen Repair Patch



P8096 5/pk
Adhesive backed fiberglass screen repair patch. Repair holes and tears. Charcoal color. 3" x 3"

TCEWS10

Screen Scrubber. No need to remove screen, just wet, wring then clean screen from top to bottom. Washable.

Splining



0.140 black polyfoam spline

- SS14500B** 0.140" x 500'

0.160 black polyfoam spline

(Fits most window frames)

- 3-SS-160-6M** 0.160" x 20'
- 3-SS-160-50M** 0.160" x 164'
- SS16500B** 0.160" x 500'
- 3-SS-160-R** 0.160" x 2700'

0.180 black polyfoam spline

(Fits most screen door frames)

- 3-SS-180-6M** 0.180" x 20'
- 3-SS-180-50M** 0.180" x 164'
- SS18500B** 0.180" x 500'
- 3-SS-180-R** 0.180" x 2250'

0.200 black polyfoam spline

- SS20500B** 0.200" x 500'



- P7940** 0.185 x 25'
- P7942** 0.185 x 100'
- P7944** 0.185 x 250'

0.185 Black Vinyl hollow core serrated spline. (Fits PL140 series window frame)

Full length magnet



SGM3690 36" x 90"
Hands Free Door Screen. Easy to install, hands free opening with magnetic closure system. Fits doors up to 36" wide.

Frames

- | | | |
|------------------|-----------------|----------------|
| Colour | A= 7/16" | A= 3/8" |
| Mill (Aluminium) | PL14039 | PL14059 |
| Bronze (Brown) | PL14041 | PL14061 |
| White | PL14042 | PL14062 |

Window Screen Frame, 94" lengths. .020 roll formed aluminium, .165" wide channels. (Sold per each or 20 per case.) (.185 spline suggested for fiberglass screen)

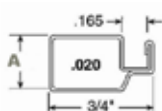

- | | | |
|----------------|-----------------|----------------|
| Colour | A= 7/16" | A= 3/8" |
| Gray | PL7724 | PL7721 |
| Bronze (Brown) | PL7725 | PL7722 |
| White | PL7726 | PL7723 |

Plastic no miter screen window frame corner. These corners allow for screen frame to be cut square for easy construction. Use with .020 screen frame in matching width. (4/pack)

4/pk



- PL14268** 7/16"
- PL14282** 3/8"

Aluminium screen window frame corner. Mitering required. .040 gauge. Match with appropriate width screen frame. (Sold per each or 100/pack)

STWOOD2

Wood handle spline roller, Wheels are non-ball bearing steel.



1-275

Plastic handle splining tool, plastic rollers.

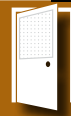

- K5108** Gray
- K5109** Black
- K5120** White
- K5174** Brown



Heavy Duty

10-1/2" Heavy Duty Pneumatic Closer for screen or storm doors. Adjustable to fit most installations. Used on heavy storm doors; adjustable closing speed.



- K5173** Brown
- K5067** Gray

10-1/2" Standard Duty Pneumatic Closer for screen or storm doors. Adjustable closing speed. Used on medium weight doors.

- MP5070** Gray
- K5071** Black
- K5171** Brown
- K5116** White

Push button latch Designed for outswinging wood or metal screen or storm doors 7/8" to 1-1/4" thick. Complete with night lock. 1-3/4" hole centers.

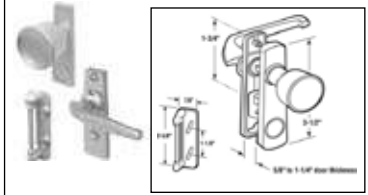

K5000 Aluminum Tulip knob latch

Designed for outswinging wood or metal, screen or storm doors that are 5/8" to 1-1/4" thick. Complete with night lock. 1-3/4" hole spacing

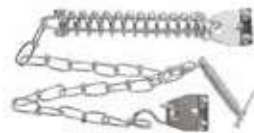

K5026 Heavy Duty 15" Door Chain. K5026 attaches to door and jam. Both are adjustable tension.



K5199 Silver
SK10B Brown
SK10W White
Inside storm door replacement lever, for openers. C/w strike



K5135 Gray
K5136 Black
Inside Latching Handle, 1-3/4" Hole Centers, Aluminium. Used to repair most push button type latches using resilient strikes.



K5003 Resilient Strike
SK2 Nylon Solid Strike Strike plate. Adjustable to fit most installations. 1-1/8" Centers

Locks



U9866
Sliding Window Locks Non-keyed for use on Sliding Aluminium Windows or Patio Doors. Dull Nickel Finish

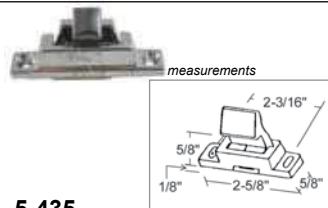

5-435
Sliding Window Jamb Latch
Jaw height is from underside of base to catch point: 5/8". Metal

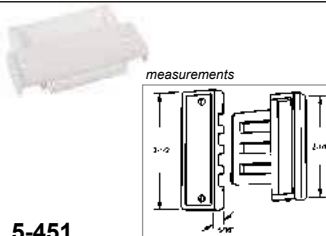

5-451
Sliding Window Center Lock
Comes with 2 screws and 2 springs.

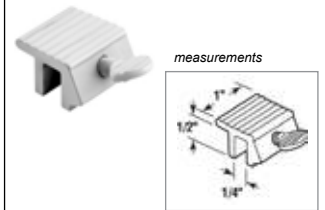

U-9802
Sliding window lock. 1", white

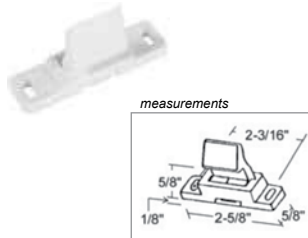

5-402 White
Sliding Window Lock

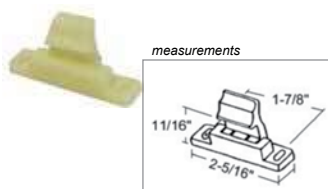

1770702 White
Nylon Window Glide, Shims Available
5-471

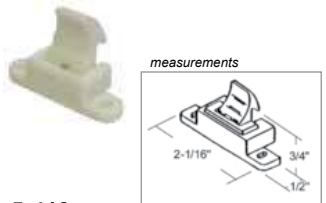

5-419
Sliding Window Lock, nylon, jaw height is from underside of base to catch point: 11/16", White

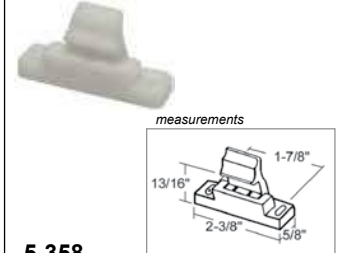

5-358
Sliding Window Lock, white

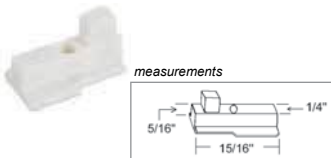

5-306
Sliding Window Glide

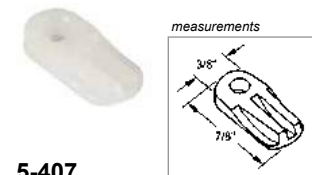

5-407
Storm Window Turn Button

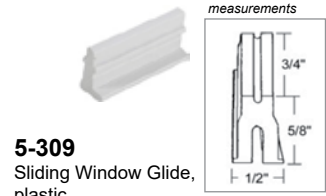

5-309
Sliding Window Glide, plastic

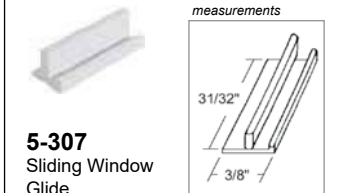

5-307
Sliding Window Glide

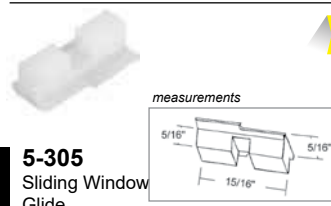

5-305
Sliding Window Glide

New!



5-338
Sliding Window Roller, plastic

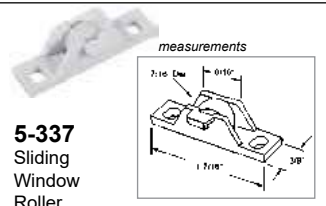

5-337
Sliding Window Roller



www.amresupply.com
for a full selection of door and window hardware repair parts



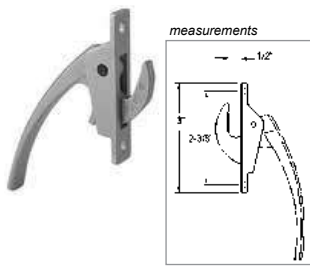

6-1345 Brown
6-1345SL Silver
 Window casement & awning. Locking Handle. die cast

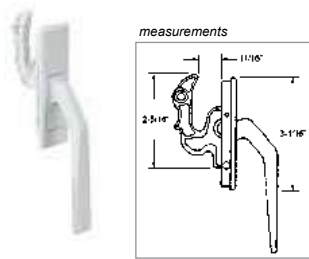

6-1335 White
 Window casement & awning. Locking Handle. Mounting holes: 2-1/2"

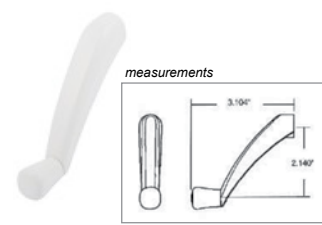

6-1467W White
6-1467B Brown
 Window casement & awning. Window Crank Handle (Contour) (Truth Hardware 5/16" Spline 11454)

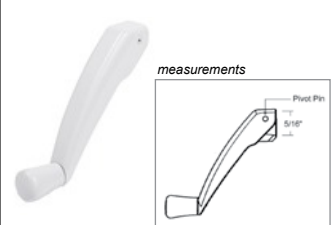

6-1410W White
6-1410B Brown
 Window casement & awning. Window Crank Handle (Folding) (Truth Hardware 5/16" Spline 11329)

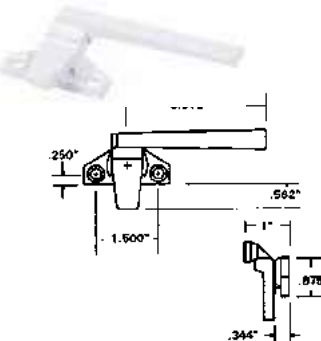

6-1332LB Left/Brown
6-1332RB Right/Brown
6-1332LW Left/White
6-1332RW Right/White
 Cam Handle Offset Base, Right Hand Shown, use with 6-1332 strike, other colours avail.

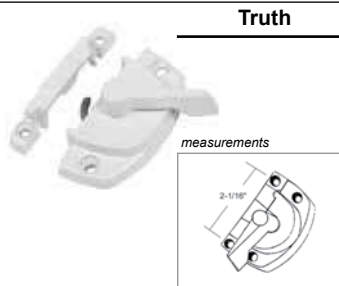

6-1363W White
 Truth Entrygard Die Cast Cam Lock. c/w lugs. OEM 17.19.32.200, 171932200

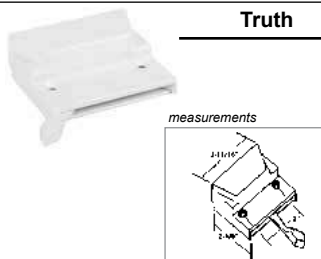

6-1359 Bronze/Brown
6-1359W White
6-1359C Coppertone
 Casement Sash Locks, Low Profile, Non-Handed

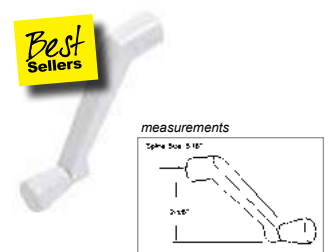

6-1301SW White 5/16"
6-1301S Brown 5/16"
6-1301SC Coppertone 5/16"
 Window Crank Handles, Metal



866570
 3/8" White (2/pk)
 Casement/Awning crank handle. Fits 3/8" Spindle.



7-1344
 Fold-Up Window Crank Handle - Spline (spindle) size: 5/16". - Will fit Truth® brand operators.

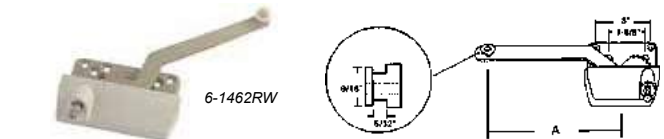

Right **6-1462RW** White
 Left **6-1462LW** White
6-1326RW White
6-1326LW White
6-1501RW White
6-1501LW White
6-1502RW White
6-1502LW White
 Truth single arm operator, brown, left hand shown. Use with 6-1308 Track. Other finishes avail. Use 6-1301 Series handles

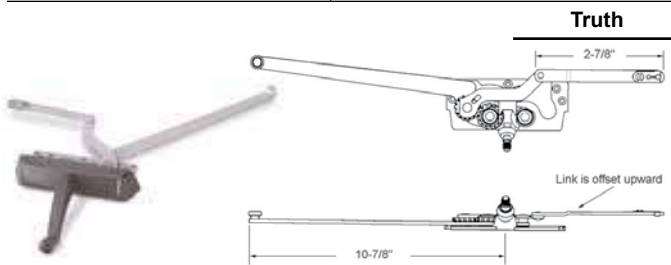

Right **6-1374R** A = 3-13/16" Left **6-1374L** Left A = 3-13/16"
6-1343R A = 4-7/16" Left **6-1343L** Left A = 4-7/16"
 Truth entry guard operators, dual arm, cover not included (6-1355). Use with 6-1354 Track. Use 6-1301 Series handles

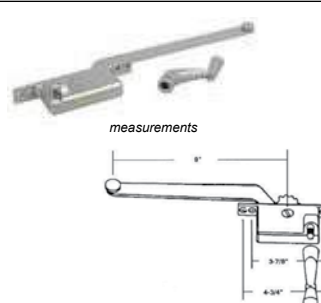

7-1368L Left
7-1368R Right
 Casement Operator Right Hand Shown.

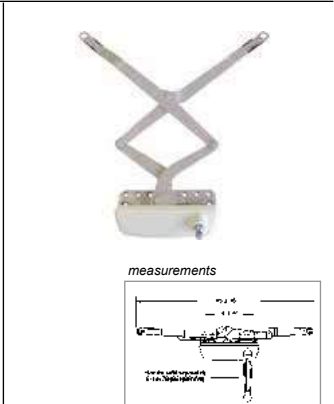

6-1449W White
6-1449B Brown
 Window casement & awning. Window Crank Handle (Folding) (Truth Hardware 5/16" Spline 11329)



6-1453LW Left
6-1453RW Right
 Maxim Dual Arm Operator, Handle sold separately



HANGING HARDWARE

Sold in full box quantities only



Prelude Fire Guard - White Ceiling Tiles

- Fire rated performance - UL approved for fire-resistive applications
- Meets all building code for nonresidential construction, hot dipped galvanized, rust resistant steel, double web construction
- Easy-Up installation - only 2-1/2" clearance required
- Spec. compliance - ICBO approved for use in seismic zones

Not stocked at all locations



ARM7891
Hanger Wire for all Armstrong grid, 12" X 12 gauge

Part#	Size	Type	Box Quantity
ARM8300RWH	12' X 1-1/2" X 15/16"	Main Beam	20
ARM8323RWH	2' X 1-3/8" X 15/16"	Stab Cross Tee	60
ARM8340RWH	4' X 1-1/2" X 15/16"	Stab Cross Tee	60
ARM7800RWH	12' X 7/8" X 7/8"	Wall Molding	30

Sold in Full Case Quantities Only!



Visit

www.AmreSupply.com
for full specs including light reflection, noise reduction etc...
Many other styles available.

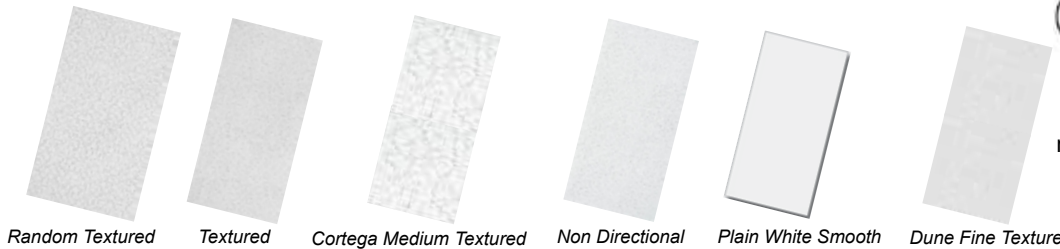

PART	DESIGN	FIRE RATING	EDGE	SIZE	PKG
ARM933	RANDOM TEXTURED	CLASS A	SQUARE	24" X 48" X 5/8"	10
ARM915	TEXTURED FIRE GUARD	CLASS A	SQUARE	24" X 48" X 5/8"	8
ARM772A	CORTEGA MEDIUM TEXTURE	CLASS A	SQUARE	24" X 60" X 5/8"	10
ARM770	CORTEGA MEDIUM TEXTURE	CLASS A	SQUARE	24" X 24" X 5/8"	16
ARM704A	CORTEGA MEDIUM TEXTURE	CLASS A	ANGLED TEGULAR	24" X 24" X 5/8"	16
ARM769	CORTEGA MEDIUM TEXTURE	CLASS A	SQUARE	24" X 48" X 5/8"	12
ARM773B	CORTEGA MEDIUM TEXTURE	CLASS A	SQUARE	20" X 60" X 5/8"	10
ARM823	CORTEGA MEDIUM TEXTURE	FIRE GUARD	SQUARE	24" X 48" X 5/8"	8
ARM1301A	NON DIRECTIONAL	CLASS A	SQUARE	24" X 48" X 1/2"	12
ARM280C	PLAIN WHITE SMOOTH	CLASS A	SQUARE	24" X 48" X 1/2"	8
ARM1773	DUNE FINE TEXTURE	CLASS A	SQUARE	24" X 48" X 5/8"	10
ARM1774	DUNE FINE TEXTURE	CLASS A	ANGLED TEGULAR	24" X 24" X 5/8"	16
ARM1775	DUNE FINE TEXTURE	CLASS A	BEVELED TEGULAR	24" X 24" X 5/8"	16

Handrail Brackets



25-P6390SC Satin Chrome
25-P6390B Brass
TAYMOR Deluxe Handrail Bracket w/Screws, 3" Projection



25-P6360SN Satin Nickel
25-P6360PB Polished Brass
50mm handrail bracket. Projection from wall is 100mm (3-15/16"), c/w screws



25-P6350SC Chrome
25-B6350B Brass
Handrail Bracket med. duty, 3" projection, other colours avail.



2281SNV Satin Nickel
2281BV Brass
Heavy duty handrail bracket, 3" projection, 2" dia. wall base, other colours avail.



We carry the full line of Armstrong ceiling tiles
Give us a call if you don't see the style you are after!

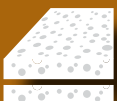
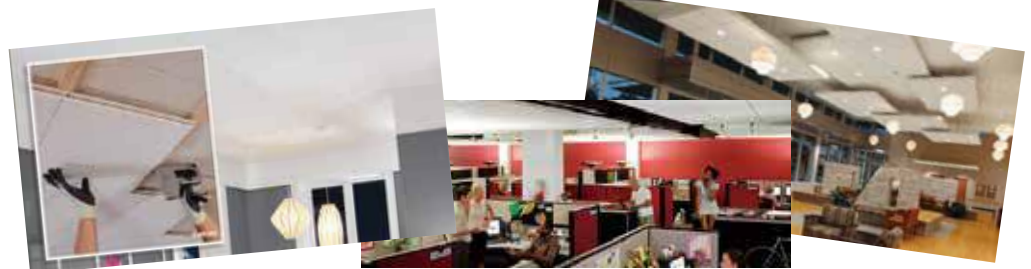

RESIDENTIAL I - BEAM KITS



Renovating?
Call us for a competitive Reno Quote and ask about our full selection of hardware!



Comes with Hardware



Commercial I-Beam for Healthcare, Education and Commercial Properties also available

Part#	Length
I-06R	6ft. (72")
I-08R	8ft. (96")
I-10R	10ft. (120")

I-Beam Track & Hardware, White Coated Steel c/w One Piece. Brackets, Screws, Rollers & End Stops Individually Bagged



R-511
Nylon Rollers, (100/pkg.)



E-01-02
Plated End Stop, (2/pkg.)



BL-01-02 (2/pkg.)
Brackets, Regular "I Beam", 1 piece construction



NEW
Appliance Repair Videos

We have added hundreds of *Do-It-Yourself* appliance repair videos to the AMRE website!

CARPET TRIMS



TA22103 3' Gold
TA22106 6' Gold
TA23103 3' Silver
TA23106 6' Silver
Aluminum Flat Joiner Trims. 1-1/4"W x 1/16"H. To join two surfaces of even height.



TA62103 3' Gold
TA62106 6' Gold
TA63103 3' Silver
TA63106 6' Silver
Aluminum Beveled Joiner Trims. 1-1/2". To join two surfaces of uneven height up to 1/4" gap.



TA52003 3' Gold
TA52006 6' Gold
TA53003 3' Silver
TA53006 6' Silver
Aluminum Canvas Back Carpet Edges. 1-5/16"W x 9/16"H. Used on carpet edges.

TRAVERSE



G9-342-1 (250/Pkg.)
Curtain Glide For Hand Traverse Track For 9-300 Series



G9-346-1 (250/Pkg.)
Super Heavy Duty Components Traverse slides, white, for all traverse rods For 400 & 600 Series



55-5313 5/Pkg
Plastic Floor Pulley, Head Rotates 360°



Part#	Code	Size
H6011	#2	1/16"

Nylon cord, (100 yards/reel)

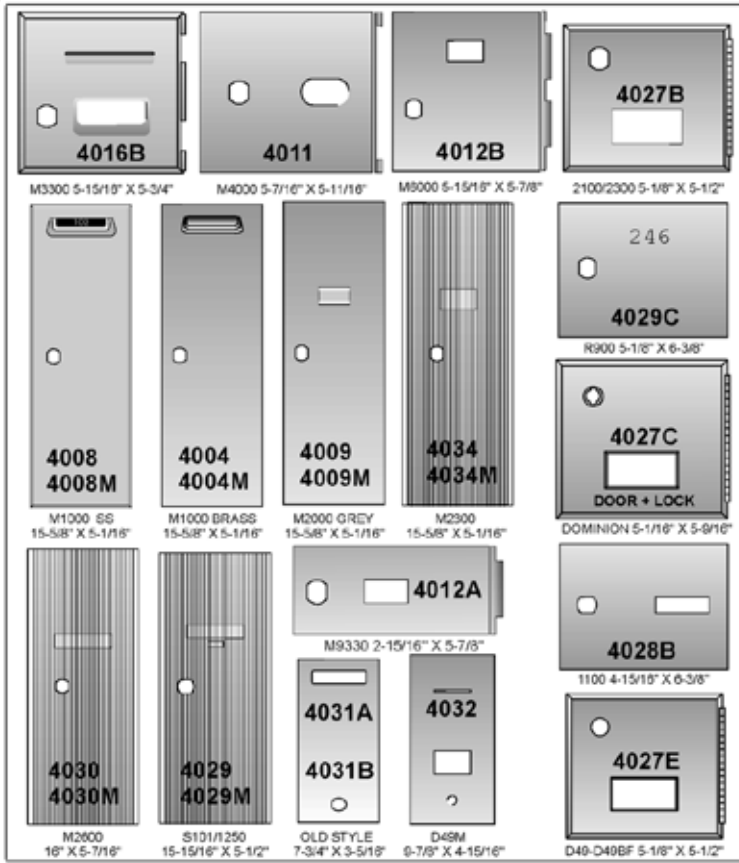

RIOPEL



RECESSED MODEL shown

# of Gangs	Recessed	Surface
1 Gang	3200A	3210A
2 Gang	3200B	3210B
3 Gang	3200C	3210C
4 Gang	3200D	3210D
5 Gang	3200E	3210E
6 Gang	3200F	3210F
7 Gang	3200G	3210G
8 Gang	3200H	3200H

Mailbox Bank. Stainless Steel Finish. Compartments are 15\"/>

RIOPEL

Riopel Mailbox Modules

The industries most trusted brand for over 50 years. Full spec drawings provided before ordering.

Special orders - NO RETURNS as all models are custom built. Numbered plates available. 4 - 8 weeks delivery, technical assistance available, contact your nearest Amre branch.

Best Sellers

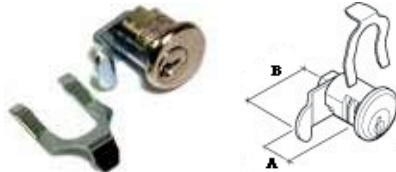

Part #	Brand/Series	A	B	Fastener
3950 (P4011)	M1/2/3000	7/16"	29/32"	Clip
3970C	CMC S101/1100/Florence	3/8"	3/4"	Clip
3953	M4000	9/16"	1-5/16"	Clip
3970A	American Device/Dorma	1/2"	1-1/2"	Clip
3954	M4-6000	9/16"	1"	Clip
3970R	GHM Rear Lock	3/8"	1-1/8"	Clip



Please allow
4-8 weeks for
delivery



VERTICAL WALLMOUNT PEDESTAL MAILBOX SERIES

MODELS 1200 / 2200 / 2300

HORIZONTAL RECESSED (MODULAR) MODELS

3300 / 3700 / 3800 / 3900

HORIZONTAL RECESSED MODELS

4000 / 6000 / 7000



HORIZONTAL RECESSED AND PEDESTAL SERIES

MODELS 6100 / 6400 / 7100 / 7400

HORIZONTAL PRIVATE MAILBOXES

SERIES 9300

37-4780 (3980, 1600)
Riopel Old Style Lock Key, Lock/Vulcan/
Brass Lori

3971R
Rousseau Door Lock w/key
3972R
Rousseau Mailbox Lock Latch

3979R w/Nut
3970P w/Clip
Multi Cam Locks. Fits most mailbox
doors in Canada



37-3250 Max 3/8" thick
37-3270 Max 7/8" thick
Cam lock for wood or metal doors or drawers
up to max thickness. Includes 2"L flat shank and
1/4" off-set shank. c/w nut, washers an plates.



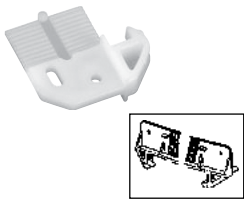

BPA12
Adjustable Drawer Glide for wood slide



BPC12
Central guide for wood rails



BPD12
Central guide for metal rails



BP603700112
Rear sockets slide 230m 2/pk



BP312
Corner Glides for T6722122234 - 4/pk



BPM12
Rear Slide Mount for T6722122234



BP10500P12
Rear Nylon Socket



BP40452G
Tandem Rollers, nylon and metal, pair



BP10500A2G
Drawer Center Roller for T40512G

Can't find what you need?
Give us a call!

DRAWER GLIDES/SLIDES/ROLLERS

Glide Center Mount



T40512G
22-3/4" Tri Roller Center Mount Drawer Slide Kit. Includes front roller, drawer slide, rear socket & center glide

T6722122234
22-3/4" Nylon Glide Center Mount Slide Kit. Includes front guides, rail, rear socket, & center glide



HINGES - Self Closing

- BP13430** White
 - BP13426** Chrome
 - BP13490** Black
 - BP134MAE** Antique English
 - BP134BORB** Brsh. Oil Brz.
 - BP134130** Brass
 - BP134195** Brsh. Nickel
 - BP134242** Brsh. Pewter
- Self-Closing Hinge, flush - 2/pk



"flush"

- BP13890** Black
 - BP13830** White
 - BP13826** Chrome
 - BP138130** Brsh. Brass
 - BP138195** Brsh. Nickel
 - BP138BORB** Brsh. Oil Brz.
 - BP138MAE** Ant. English
- Semi-Concealed Self-Closing Hinge, inset - 2/pk



"inset"

- BP139130** Brass
 - BP139195** Nickel
 - BP139MAE** Ant. English
- Self Closing Hinge - 2/pk



DRAWER SLIDES, SIDE MOUNT

- TP10230030** 300mm
 - TP10235030** 350mm
 - TP10240030** 400mm
 - TP10245030** 450mm
 - TP10250030** 500mm
 - TP10255030** 550mm
 - TP10260030** 600mm
- 75 lb Drawer Slide, White, Sold as Pairs

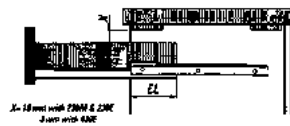

CABINET CATCHES



BP52030 Wh
20-1455AC A/C
Single Magnetic Catch



BP659130
White, Double Magnetic Catch



BP6032G
Double Roller Catch



7569130
Plastic Roller Catch, White



20-1410Z
Roller Latch, double outside clip, chrome



25-5316ORB Oil Rub. Bronze
25-5316SC Satin Chrome
25-5316SN Satin Nickel
Taymor 6" Flush Bolt

BP812422G Zinc
Hinge for 3/4" Door - 2/pk



UC91M255180 Nickel
Screw-On Hinge, 100°, Self Close, Overlay Door, Straight-Arm. Each



UC91A650180 Nickel
Screw-On Hinge 170° Self Close Overlay Door, Straight-Arm



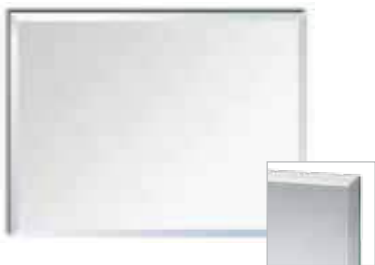

20-1120 20" x 24"
20-1200 24" x 36"
20-1240 30" x 36"
20-1260 30" x 42"
 Regular bevelled edge frameless mirror (3mm thick.) Come with mounting hardware. Custom sizes available, call for quote.



Mirror Clips

14-805 1/4"
14-804 3/16"
14-803 1/8"
 Mirror clips



14-802
 Metal L clip



14-800A 3/16"
14-800B 1/4"
 Mirror clip



New!



B-165-1830 18" x 30"
B-165-1836 18" x 36"
 Bobrick Commercial Framed Mirror. Secured to concealed wall hanger with theft-resistant mounting.

Medicine Cabinets



BL-602 16" x 22" Recessed
BL-612 16" x 22" Surface
 Stainless Steel trim. 5mm mirror. Full length piano hinge. Adj. shelves. Reversible door. 4-1/2" depth, *with bevelled edge. (4" on recessed).



Wood Edge



MC1620W 16"x20" White
 1 Door Wood Framed Cabinet American Classics by RSI. 4-1/2" shelf depth. Surface mount. Adjustable shelf included. Concealed adjustable hinges.



Wood Edge



MC2424W 24"x24" White
MC3029WH 30"x29" White
3 Door Wood Framed Cabinet
 American Classics by RSI. 4-1/2" shelf depth. Surface mount. Adjustable shelves included. Concealed adjustable hinges. Available in White wood or oak.



Bevelled Edge



GS-2426* 24" x 26" (5"d)
 *2Door
GS-3026 30" x 26" (5"d)
GS-3630 36" x 30" (5"d)
3 Door Bevelled Mirrors Cabinet
 Steel body, 5mm mirror thickness, surface mount, full access storage, adjustable hinges. GS series by Galaxy has epoxy coated steel body and requires assembly. *GS-2426 is only 2 door.



NEW
Appliance Repair Videos

We have added
 hundreds of
Do-It-Yourself
appliance repair videos
 to the **AMRE website!**



Part# Size
941-1630FT 16"w x 30"h
941-1824FT 18"w x 24"h
941-1830FT 18"w x 30"h
941-1836FT 18"w x 36"h
941-2430FT 24"w x 30"h
941-2436FT 24"w x 36"h
Barrier Free Fixed Tilt Mirrors One piece 24 ga. stainless steel channel frame provides rigid assembly. Comes in bright annealed finish. Fixed tilt frame is one piece 20 ga. stainless steel. Vandal resistant concealed mounting. 4mm glass with shock resistant primary back. Full galvanized back panel.



Chrome
02-D6002 Double Robe Hook
02-D6008 Standard Paper Holder
02-D6048 Euro Paper Holder
02-D6004 Towel Ring
02-D6018 18" Towel Bar
02-D6024 24" Towel Bar
02-D6030 30" Towel Bar

Satin Nickel
02-D6002SN Double Robe Hook
02-D6008SN Paper Holder
02-D6048SN Euro Paper Holder
02-D6004SN Towel Ring
02-D6018SN 18" Towel Bar
02-D6024SN 24" Towel Bar
02-D6030SN 30" Towel Bar

Orion Series. Concealed surface mount. Includes mounting hardware and installation instructions. Lifetime warranty.

Chrome
02-D8402 Double Robe Hook
02-D8408 Paper Holder
02-D8404 Towel Ring
02-D8418 18" Towel Bar
02-D8424 24" Towel Bar
02-D8430 30" Towel Bar

Satin Nickel
02-D8402SN Double Robe Hook
02-D8408SN Paper Holder
02-D8404SN Towel Ring
02-D8418SN 18" Towel Bar
02-D8424SN 24" Towel Bar
02-D8430SN 30" Towel Bar

Infinity Series. Concealed surface mount. Includes mounting hardware and installation instructions. Lifetime warranty.

01-9402 Twin Robe Holder
01-9401 Single Rob Hook
9408 Paper Holder
01-9404 Towel Ring
01-940024 24" Towel Bar

Sunglow Series. Concealed surface mount. Includes mounting hardware and installation instructions. Lifetime warranty. Chrome

Orion - Builders Kits

02-D6050 chrome
02-D6050SN satin nickel

Orion 4 piece bathroom accessory kit. Includes double robe hook, toilet paper holder, towel ring and 24" towel bar.

Upgrade Easily With This New Mason Series!

YB8003CH Double Robe Hook
YB8086CH Towel Ring
YB8000CH Towel Bar & Paper Holder Posts
YB8099CH Toilet Paper Holder Only
YB8098CH 18" Towel Bar Only
YB8094CH 24" Towel Bar Only

Mason Series. Order toilet paper holder and/or towel bars with posts for a complete accessory. Pro-fit installation system including template with a built-in level- eliminating set screws. Limited lifetime warranty. Other colours available. Chrome

9400 Chrome
 Taymor Towel Bar Posts with Concealed Screw Mounting, 3/4"

PART#	LEN.
01-R940018	18"
01-R940024	24"
01-R940030	30"
01-R940036	36"

Taymor 3/4" Towel Bars Only Chrome Order Post Ends Separately (9400)

01-NC1760 Chrome
 Ultra 4 piece bathroom accessory kit. Includes single robe hook, toilet paper holder, towel ring and 24" towel bar.

Sunglow - Builders Kits

02-D9450 chrome

Taymor Sunglow 4pc Bath accessory kit. Chrome Finish Comes with: 24" Towel Bar Surface Mount Toilet Paper Holder Double Robe Hook Towel Ring

Soap Holder - Shallow



01-1862S Chrome
Taymor Shallow Soap Holder & Grab Bar, 1 1/8" Deep
Overall Size 6 1/8" X 6 1/8"
Wall Opening 5 1/8" X 5 1/8"
Screw In

Soap Holder - Deep



01-102S Chrome
Taymor Deep Soap Holder & Grab Bar, 2" Deep
Overall Size 6 1/4" X 6 1/4"
Wall Opening 5 1/4" X 5 1/4"
Screw In

Paper Holder - Deep



01-101S Chrome
02-D101SSN Satin Nkl
Taymor Deep Recessed Paper Holder (Plastic Roller) 2" Deep
Overall Size 6 1/4" X 6 1/4"
Wall Opening 5 1/4" X 5 1/4"
Screw In

Paper Holder - Shallow



01-1863S Chrome
Taymor Shallow Recessed Paper holder (Plastic Roller) 1 1/8" Deep Overall Size 6 1/8" X 6 1/8"
Wall Opening 5 1/8" X 5 1/8"
Screw In



01-R111W White
01-R100 Chrome
Taymor Plastic Spring Roller Replacement



ULN263
Plastic spring roller with small ends



01-R112
Taymor Soap dish, clear plastic, for 01-1862S, 01-102S



01-9406 Chrome
Taymor Soap Dish



01-1861S Chrome
Taymor Recessed Soap Holder. Non-removable soap dish.
Overall Size 6 1/8" X 6 1/8"
Wall Opening 5 1/8" X 5 1/8"



01-9405 Chrome
Taymor Toothbrush & Tumbler Holder



631A
Chrome Shower Rod Oblong Flange, c/w screws sold as pair



ULN508 Metal
52-F Plastic
Adjustable Rod Holder. Ends Only, sold as pair

SHOWER RODS



CSR2165CH Chrome 59"
CSR2165BN Brushed Nickel 59"
CSR2160CH Chrome 54-72"
CSR2160BN Brushed Nickel 54-72"
Moen curved shower rod. Corrosion resistant



02-D9688 Pol. Chrome
02-D9688SN Satin Nickel
Taymor curved shower rod. Adjustable from 52" to 72"
- Coated rust free protection
- 25% more room
- 8" more elbow room
- Includes hardware and instructions

1291 White
1292 Chrome
Spring Tension Adjustable shower rods 36" - 63". Powerful tension. Double tapered center ring prevents curtain from getting caught. Rubber end caps prevent slipping.



1596 5' Aluminium
01-R9686 6' C.P. Aluminium
597 5' C.P. Steel
01-R9696 6' C.P. Steel
Shower Rod Only



01-9629W 60" (5')
Vinyl Cover Closet And Shower Rod Cover Lets Hangers Glide Smoothly, Wraps around wood dowel or metal pipe.

1144-502 48" x 78"
1144-503 70" x 72"
Commercial Rated Shower Curtain. 100% PVC w/reinforced aluminium grommets concealed in extra strength header. 8 gauge/.2mm. White. Rods and rings sold sep.





Residential/Light Commercial Bath-Aide Safety Bars

- 1" Outside diameter safety bars.
- Suitable for residential or commercial use.
- Safety engineered to withstand 300lb pull when installed correctly.
- White has non-slip powder coating
- Polished chrome is knurled for grip.
- Exposed screw mount.

Item	Chrome	White
12" Straight Bar	03-4912	03-5912
16" Straight Bar	03-4916	03-5916
18" Straight Bar	03-4918	03-5918
24" Straight Bar	03-4924	03-5924
32" Straight Bar	03-4932	03-5932
12"x12"x135° Bar	03-4905	-



LR2250DW 9"

Safety, comfort and peace of mind. Glacier white, supports up to 250 lbs, 9" bar length, 0.875" bar diameter, corrosion resistant, plastic construction for added durability

Taymor Designer Series Safety Grab Bars

- 03-6916PSS 16"**
- 03-6924PSS 24"**

Astral Safety Grab Bar. Ergonomic non-slip finger grip. ADA compliant, concealed mount. Withstands 300lbs/136kg pull. Polished stainless steel. Matching bathroom accessories available.

Available in Aged Bronze



- Taymor 03-7916PSS 16"**
- 03-7924PSS 24"**

Brentwood Safety Grab Bar. Ergonomic non-slip finger grip. ADA compliant, concealed mount. Withstands 300lbs/136kg pull. Polished stainless steel. Matching bathroom accessories available.



Commercial/Institutional Grade Grab Bars



Safety assured "Anti-bacterial Non-Slip" Peened Grip. Safety engineered to withstand 300lbs downward pressure if properly installed. Meets or exceeds building washroom safety codes. 1-1/2" wall clearance for full grip allowance & accident prevention. Full compliance with North American A.D.A/Barrier legislation. Durable corrosion resistant type 304 stainless steel, 32D finish. 18 gauge tubing with 14 gauge flanges. 2" Stainless Steel installation screws. 1-1/4" dia.

Concealed Mount - 1-1/4" Straight - Peened Grab Bars, c/w flanges

Satin St. Steel #	Size
01-TC220012	12"
01-TC220018	18"
01-TC220024	24"
01-TC220030	30"
01-TC220036	36"
01-TC220048	48"



CONCEALED SCREW MOUNT

Angle Grab Bar

1-1/4" Dia. 24"x24"x120°. Peened Grab Bars. C/W Flanges - Non Handed

Satin St. Steel #	Size
01-TC22120	Concealed Mt

Q511SP

Splash Guard, Comes In Pairs, w/shower curtain clips and self adhesive strips



01-1010 - Chrome Recessed Tissue Holder. 11-15/16" x 6" x 2-3/8". See Janitorial section for other models



02-D1099 Chrome Retractable clothes line. 3-5/8" dia x 1-1/8"d, 7' nylon cord.

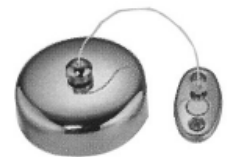

01-1062 - 2 Guest (12"H x 6-1/4"W x 4-9/16"D)
01-1064 - 4 Guest (21-3/8"H x 6-5/16"W x 4-1/2"D)
 Guest Towel Holders Available from 2-4 guest sizes. Chrome finish. Towels not included.



01-1043 18" Chr.
01-1044 24" Chr.
 Towel shelf with towel bar. 8-1/2"H x 9"D. Stainless Steel is polished.



05-1086S - Small
05-1086M - Medium
05-1086L - Large
 Chrome corner basket. Small: 5"W x 8-1/4"L x 1-5/8"D
 Med: 5-1/2"W x 9"L x 2-1/2"D
 Lg: 8"W x 13-5/8"L x 3-1/2"D





Barrier-Free Latches



Quotes available for complete bathroom partition stalls. Give us a call!

hadrian® Shanahan's

Stainless steel toilet partitions feature industry-best fire resistance, high recycled content and excellent corrosion resistance.

Stainless steel achieves an upscale look and outstanding performance.



Emergency Access Latches . Stainless Steel Brackets . Coat Hooks

Door Hinge Parts - UPPER & LOWER

hadrian®



601600
Male Cam Assembly



601700
Female Cam



601300
Upper Hinge Assembly



601350
Upper Wrap-Around Hinge



640003
Upper Door Casting



610140
Upper Hinge (Saddle Type)



601500
Lower Hinge Assembly



601550
Lower Wrap-Around Hinge



640004
Lower Door Casting

Turns . Latches . Handles



610112
Door Pull, chrome, 5.5". Set of two, screws included.



601100
Inner Knob



601200
Outer Knob



601110
Inner Knob: Handicapped



610121
Surface Slide Latch W/Fasteners



610110 3 1/2"
C.C. Door Pull W/Fasteners

Stops . Keepers

hadrian®



601850
Outswing Door Stop W/Fasteners



601800
Door Stop & Latch Keeper (Standard)



610118
Alcove Door Stop & Latch Keeper W/ Fasteners



610131
Inswing Surface Door Stop & Latch Keeper W/Fasteners



610135
Outswing Surface Door Stop & Latch Keeper W/Fasteners



601900
Coat hook and bumper



hadrian® Shanahan's

Brackets . Channels . Posts



602110H
1" Wall Screen Bracket
(3 1/2" O.A. Projection)



603110
1" Panel Intermediate
Bracket (2 1/2" O.A.
Projection)



603210
1" Panel End Bracket
(2 1/2" O.A. Projection)



604110
1 1/4" Panel Pilaster
Wall Bracket (2 1/2"
O.A. Projection)



603111
1" Panel Wainscote
Bracket
(3 1/2" O.A. Projection)



604111
1 1/4" Wainscote
Pilaster Bracket
(3 1/2" O.A. Projection)



601950
Alcove Clip
1" x 1 1/4"



607110
Headrail Bracket



603520
"U" Type Bracket



607210
Headrail Corner Clip



607220
Headrail End Cap



607230
Pilaster hole cover

Pilaster Parts



604200
Headrail kit inc. hard-
ware and levelling
channel



604220
Leveling Channel



607400
Floor Mounted Fasten-
ing Assembly



604410
Panel Post Shoe
(for 1 3/4" sq. post)



550003 3"
550004 4"
550005 5"
550006 6"

550007 7"
550008 8"
550010 10"
550012 12"
550014 14"
550018 18"
550020PS 20"
550023 23"
Pilaster Shoes

Door Hinges

Shanahan's



TS-150
Upper Hinge



TS-140
Lower Hinge

Turn . Latch . Handles

Shanahan's



S-110
Inner/Outer Knob &
Latch Kit



TS-300
Surface Slide Latch



Post Flanges available for
Shanahan's
**Call us with your
size requirements.**

Stops . Keepers . Shoes

Shanahan's



TS-120
Door Bumpers & Coat
Hook



TS-401
Surface Bumper



5230
Strike & Keeper

Brackets

Shanahan's



S-100
1-1/4" Panel End Bracket Kit

Brackets . Channels . Posts

Shanahan's



TS-170
Headrail Bracket



TS-200
Wall "U" Type



TS-140-1
Alcove "L" Bracket



S-190
Post Cap



TS-160
Headrail End Cap

24 HR.
Order by
4pm for
24-48hr shipping
to almost anywhere in
Canada!



Oatey



31585 118ml
31586 236ml
 PVC CEMENT Purple-tinted all purpose primer/cleaner for PVC and CPVC. Less aggressive than clear primer and purple primer. Removes surface dirt, grease and grime as well as softens pipe in preparation for solvent cement.

Oatey



31540 118ml
31541 236ml
31542 473ml
31543 946ml
 ABS CEMENT
 Medium bodied yellow cement for ABS pipe and fittings up to 6" diameter. For non-pressure applications. CSA Approved

Oatey



31505 118ml
31513 946ml
 PVC CEMENT
 Heavy-bodied gray coloured cement for use on PVC pipe & fittings. Up to 12" diameter for Sch. 40 & Sch. 80. Recommended for all grades & types of PVC pipe & fittings, potable water, pressure pipe, gas, conduit and DWV.

Oatey



31531 236ml
31530 473ml
31532 118ml
 ABS CEMENT - TRANSITION CEMENT
 Medium-Bodied White coloured cement for use in joining ABS to PVC in non-pressure transition joints up to 6" diameter.

New!



31580-O 118ml
 RAIN-R-SHINE PVC CEMENT
 Medium-bodied cement for PVC pipe and fittings. Fast-setting cement formulated for wet conditions and/or quick pressurization.

Oatey



48006 8oz, Can/Brush
 PIPE JOINT COMPOUND
 Non-hardening gray paste seals and lubricates threaded joints. For use on water, steam or air lines. Non-separating and non-toxic material. Not for use on plastic threads.

Oatey



48330 4 oz.
158069 8 oz.
 PIPE JOINT COMPOUND
 Great Blue. Flexible blue, non-hardening, non-separating, nontoxic paste, no odour, easy cleanup. Use on PVC, CPVC, ABS, polyethylene, polypropylene, iron, steel, copper or brass threads up to and including 2".



7509-001 2 oz.
 Teflon paste, Pure white thread lubricant & sealant. Apply to metals, PVC, CPVC & ABS, polypropylene & nylon. Dries slowly, non-hardening. Withstands up to 3,000 PSI on gases. For temperatures -50 to +500°F



7507-001 1 oz
7507-004 1/2 pint
 T.F.E. paste made with teflon Thread Lubricant and Sealant. Withstand up to 10,000 PSI and Temperatures from -100°F to 600°F



1711 - 90ml
 PLUMBERS GLOOZIT
 Patch leaks in plastic, copper, steel and cast iron pipes. Attach ceramic soap dishes to tile. Repair garden hoses. Repair leaks in gutter, down pipe and seams on eavestroughing. Cement plastic pipe together.

LEPAGE



32246 59ml
 Plumbers Choice Sealant Seal leaks around pipe joints, repair cracked porcelain, secure towel bars, repair loosened tiles, mend tears in PVC tubing. Works on aluminium, brick, tile, fiberglass, plastic, porcelain, PVC tubing, rubber, steel etc... 45 min set time, 48hr cure.

Oatey



48003 14 oz
48004 5 lb
 Plumber's Putty stainless fixture setting compound for setting frames, rims, strainers, faucets, etc... Workable soft, pliable material stays flexible and will not crack or dry out. Not for use on granite, marble etc...

Epoxies

Oatey



31270 4 oz..
 Convenient multipurpose sealing epoxy, patching and mending compound. Steel filled material, mixes in the hand and hardens in minutes.

LEPAGE



00391-3
 5-Minute Epoxy for glass, metal, plastics and concrete. Waterproof, heat & cold resistant epoxy adhesive. Dries clear Super strong Water resistant Bonds metal, glass, ceramic, wood, masonry, some rubber and many rigid plastics quickly and permanently



4200602 0.85oz/25ml
 Gorilla Epoxy. Incredible performance, 5 minute set time, easy to use syringe, dries clear, works on almost any material.





5202402 22ml
Gorilla Dries White Precision Pen. The same serious strength you expect from Gorilla Glue, in a Dries White, 2X Faster formula.



7600101 15g
7710101 20g
Gorilla Super Glue Gel Formula. Thicker more controlled formula, great for vertical or multiple surfaces.



7900103 .11oz/3g
7900301 2 x 3g
7805201 .71oz/20ml
Super glue. New Formula sets in 10 seconds to almost any material. Anti-clog tip.



5100502 **51008T**

5100502 4 x 3g Single Use Tubes
5100201 2oz/60ml
5100402 4oz/118ml
51008T 8oz/236ml
Gorilla Glue™. Bonds to almost any material. Sandable, paintable, 100% waterproof.



6212002 4oz/118ml
6200201 8oz/236ml
6205201 18oz/532ml
Gorilla Glue™ Wood Glue. Indoor/outdoor use, a PVA glue that fully cures in 24hrs, only requires 20-30min clamp time.



7510101 10g
Gorilla Super Glue with Brush and Nozzle. Precision tip nozzle and fine bristle brush for control and accuracy. Dries in seconds

Heat Resistant

3M



EC847 5oz, 3M
Rubber & Gasket Adhesive A premium adhesive. Develops strong flexible bonds very rapidly to a wide variety of substrates, incl. plastics, rubbers & gasketing materials.

WH60X15 5oz
Great for dishwashers and washers. Air dries to flexible seal that resist weather, water, oils, and fuel. Useful over a temperature range of -65 to 200°F

LOCTITE



32242 6ml
Blue Threadlocker Locks threaded fasteners against vibration loosening. Ideal for nut and bolt applications 1/4" to 3/4". Prevents threads from rusting and leaking. Removable with hand tools for easy disassembly. Temperature -65°F to 300°F

Sprays

3M

"Large 24oz Size"



SUPER77 24 oz
3M Super 77 Multipurpose Adhesive A strong-bonding, fast-drying glue that you just spray on. From paper, cardboard, fabric and cushion foam to plastic, metal, wood. Super 77 sticks to just about anything.

3M

"Large 24oz Size"



SPRAY90 24 oz
High performance, premium quality formulation that dries clear and has superior bonding strength. For on a variety of porous and non porous materials.

LEPAGE



1673141 212g
No More Nails All Purpose Instant Grab Construction Adhesive. Premium quality, latex-based for interior construction and multi-purpose use, new, clear-dry technology, low odour, water cleanup



New!



6341502 396g
Gorilla Spray Adhesive. A heavy-duty, multi purpose, easy to use adhesive. Use indoors and outdoors

White/Yellow Glues

LEPAGE



00284-0 400ml
Wood Glue ideal for outdoor wood projects; all season durability, water resistant high initial tack, dries translucent; sandable; paintable

LEPAGE



00224-0 400ml
White Glue For bonding paper cardboard, leather and porous materials. It dies translucent, is non toxic, paintable and sandable. Unique easy flow, non-slip, non-rolling bottle

LEPAGE



00254-0 400ml
Carpenters Glue The best choice for wood working projects that demand the best adhesive. Strong initial tack sets in just 15 - 25 minutes reducing clamping and assembly time. Carpenter's glue dries translucent and has superior sandability.

Super Glues



32237
QuickTite® Super Glue Easy Squeeze Gel No-clog nozzle Locking cap collar prevents leaks and drying out Drop or bead control Blue Easy Squeeze grips Small opening, no drip, precise nozzle

Contact Cements

LEPAGE



01652-0 237ml

1536624 1.5L

Pres-Tite Green Contact Cement This 100% solvent-free water-bourne contact cement provides strong bond with excellent creep resistance. Ideal for bonding laminates and wood veneer to cabinets and counter tops. Bonds to particle board, plastic laminates, plywood, veneers, metal, rubber, etc.

LEPAGE

01541-2

01453-2



01545-2

01541-2 250ml Brush & Can

01453-2 946ml

01545-2 3.8L

Pres-Tite Blue Contact Cement Higher strength version bonds are resistant to heat, creep, water and oil. Applies evenly with a brush, dries fast and bonds on contact with no clamping required. It bonds particle board, plastics, laminates, plywood, wallboard, veneers, metal, cork, fabric, rubber and more.

Adhesives



8110003 266ml

Gorilla Glue Construction Adhesive. Versatile all-weather 100% adhesive formula. Indoor/Outdoor bonds to virtually anything. Low odor, gap filling, paintable

LEPAGE



PL400 295ml

A Heavy Duty Sub-Floor Adhesive for projects such as sub-flooring, exterior sheathing and siding. Bonds to almost all woods, masonry, metal, wet, pressure treated & frozen lumber. Permanent bond within 48hrs. Ideal for interior/exterior use. Not damaged by freezing.

LEPAGE



1403221 295ml

PL PREMIUM Construction Adhesive. 3X stronger than normal construction adhesives therefore less required. Bonds to almost any construction material.

LEPAGE



01597-1 (PL9000) 295ml

Construction Adhesive A premium grade adhesive for demanding construction jobs. Bonds most common building materials including wood, concrete, brick, drywall, metal, fiberglass panel, wallboard, cork. For interior and exterior use. Very high initial grab.

LEPAGE



PL200 295ml

Panel and construction adhesive that permanently bonds panelling, drywall, wood moulding etc. to most common building materials. Minimizes unsightly nails and hammer dents. Resistant to moisture and temperature fluctuations. Allows up to 10min for adjustments

LEPAGE



1469892 266ml

No More Nails® ULTRA Construction Adhesive is a premium quality, heavy duty, gap-filling adhesive for both indoor and outdoor projects. It has an extremely high tack and is weather resistant and paintable

LEPAGE



02001-0 177ml (squeeze tube)

02000-0 266ml

No More Nails construction adhesive that will bond to most common materials including wood, plaster, brick, metal, some plastics, ceramics and glass. Bonds quickly & fills minor gaps surface gaps such as brick and plaster; one surface must be porous. Can be painted or sanded. Safe & Odour-free.

Tub Wall Adhesives

LEPAGE



PL700 295ml

Tub Surround Adhesive For bonding bathtub and shower surround kits to walls. Bonds are unaffected by moisture, steam, water, heat or cold when fully cured. Perfect for plastic panels will not deform plastics or other composite materials. Fast setting, easy to use. Not damaged by freezing.

LEPAGE



1442490

Tub & Shower Surround installation kit. Contains 3pcs 295ml PL700 tub surround adhesive and 1pc 295ml white Ultra Seal kitchen and bath acrylic sealant (water clean-up, resists mold and mildew)

LEPAGE



01-06779 295ml

No More Nails Tub Surround Adhesive

This adhesive has very high initial tack which reduces the need for bracing. It provides superior bond strength for adhering tub/shower surrounds without etching or burn through. It is unaffected by moisture, steam, water, heat or cold when fully cured. Cleans up with water, low odour.

Specialty Adhesives



2172 300ml

Premium All Weather Plastic Roof Cement forms a tight, strong seal. Use on dry or damp surfaces and stays soft and pliable



71872 300ml

Cove Base Adhesive Latex formula for installing rubber and vinyl cove base. Resists cracking and drying out. Excellent water resistance. Low VOC.





6065102 60"
Gorilla Mounting Tape. Holds up to 10lbs. Indoor/outdoor on most surfaces, permanent bond.



6100102 1" x 10yds
60124T 1.88" x 12yds
6035060T 1.88" x 35yds
Gorilla Heavy Duty Duct Tape sticks to even rough surfaces like brick, stucco, wood etc... All weather.



6003001 2.88" x 30yds
Gorilla Tough & Wide Duct Tape. Bigger and tougher this tape covers more surface area and creates a stronger bond!



6127002 1.88"x27"
Gorilla Clear Repair Tape. To fix, patch, seal, protect and hold almost any surface.



6010002 1.88" x 10yds
6025001 1.88" x 30yds
Gorilla White Duct Tape. Same amazing product only in white to hide repairs on white surfaces, won't yellow, UV resistant.



6013902 1.88" x 9yds
Gorilla Camo Duct Tape. Same amazing product only in camouflage, matte finish for use on hunting, fishing, camping applications and more.



New!



6145002 32m w/ dispenser
6130402 2 x 32m refill rolls
Gorilla Tough & Wide Packaging Tape. The ultimate solution for moving, shipping, and storing. 3" wide.



30924 24mm (1")
30936 36mm (1-1/2")
30948 48mm (2")
PAINT PRO® MASKING Special rubber based adhesive that adheres well to all clean surfaces and peels off cleanly after extended use both indoors and outdoors



30218 18mm (3/4")
30224 24mm (1")
30236 36mm (1-1/2")
30248 48mm (2")
GENERAL PURPOSE MASKING Perfectly suited to various applications, adheres well to any clean and smooth surface.



TA50635 1-3/8" x 42',RCR
343DC-NA 1-1/2" x 42'
Carpet Tape Indoor/Outdoor Weatherproof Reinforced double-sided cloth tape for heavy traffic areas. Adheres well to rough surfaces, even patios and pools, concrete, metal, wood, tile, etc. Easily removable.



CH77430



ADT4850X

CH77430 1.88" x 26' (RCR)
ADT4850X 2" x 164' (3M)
Aluminium Foil Tape Coated with a very strong acrylic adhesive that forms a bond that strengthens with time. Ideal for all duct sealing. Easy to peel backing.



CH77130 1.88" x 26' ft.
219-1X60 1" x 60 yds.
219-2X60 1.88" x 50 yds.
Duct Tape, Polyethylene coated cloth backed tape with a specially formulated pressure sensitive adhesive. Professional quality. 219-2X60C Other colours available!

778548
No More Nails mounting tape, double-sided tape for fast, clean and durable mounting indoors and outdoors. One roll can hold up to 50 kg. Recomm. for: tiles, metal, wood, stone, glass and plastics including PVC, polyethylene, polypropylene and Nylon®.



CZ91508 1" x 8'
CZ91516 1" x 16'
Plumbing Emergency Repair Tape, perfect for any repair in plumbing applications, J-bends, hoses etc... Cuts wet or dry.



T001801 3/4" x 66"
Electrical Tape, Black professional quality for all of your electrical taping needs. Other colours avail.



0205 2.3" x 216"
Tuck Tape Designed for sealing joints of sheathing materials. Permanent strong adhesive. Adheres to plastic, metal and smooth surfaces. Works in hot & cold weather. Resists UV rays. CCMC approved.



213-503 White 1/2"x480'
31402D Pink Ind. 1/2"x260'
203-480 Yel. Gas 1/2"x260'
Teflon Tape 1/2" wide
- White is standard grade for water
- Pink is industrial for water
- Yellow is used on Gas lines

An unbelievable product that is a must try! See website for video



ALLP36 3" x 6" patch
ALLP69 6" x 9" patch
UVFLSH51 UV Flashlight QuickPatch Fiberglass Repair Patch. Bonds to wood, fiberglass, metal, plastic, glass and more. Expose to outdoor light or use UV light.



Sprays

JA1010 20oz. (576g)
Teflon spray javelin nut and bolt loosener. Frees rusty nuts, bolts and fittings in seconds; eases metal-to-metal contact
High dielectric strength of 39,500V per 0.1" - safe around electrical components. Effectively displaces water - dries out electrical components
Wide Temperature Range: -60°F to +525°F (-51°C to +275°C)



L312 11 oz
The Liquid Wrench Non-Flamable Super Lubricant with Teflon - lubricates and protects all metal parts against wear, rust and corrosion. The Liquid Wrench L312 uses fast penetrating solvents to free rusted and frozen bolts.



A00910 12oz
Food Grade Silicone Lube
Low-viscosity, silicone lubricant. USDA H-1 rated, NSF listed. Prevents sticking without transferring to end products. -58°F to +575°F. Uses: Slides, guide rails, knives, slicers, saws, grinders, dough mixers, guards, heat sealing equipment, conveyors, food racks, ovens, bottling machines, all food and drug processing equipment.



WD40 12oz (311g)
Multipurpose lubricant used to free and clean rusted parts, stop squeaks, & protect all metals. Will not oxidize or cause small mechanisms to gum up.



S00206 10oz
All Purpose Silicone Lube
5% silicone formula. Reduces friction and sticking; protects against corrosion and oxidation. Effective from -50°F to +375°F. Uses: Rubber moldings, windows, sliding wood surfaces, sliding racks, dissimilar metals, springs, doors, hinges, weather-strip & plastic assemblies.



800210 10oz
Food Grade Silicone, colourless, odourless low-viscosity lubricant. Prevents sticking without transferring to end products. Will not attack delicate surfaces such as styrene or urethane



S00200 11oz
Dry Moly Lube Penetrates pores of substrate & bonds to surface for long-lasting lubrication. High-pressure, high-solids molybdenum disulfide coating. Withstands pressures up to 50,000 psi. Air dries in 5-10 minutes; cures in 2 hours at room temperature.



45804 16oz. Spray
All purpose leak detector, detects leaks quickly on all types of tubing, valves, cylinders, pressure tanks or other systems under air, gas, or oxygen pressure. Slow evaporation rate



Grease

17-130 1-1/4 oz

17-131 8 oz

Lith-ease Grease. A high quality, multipurpose white lithium grease. Has superior film strength as well as excellent water and heat resistance.



A00100 11oz
White Lithium Grease
Inhibits corrosion on unpainted metal surfaces. High-solids, non-staining white grease. Excellent for metal-to-metal applications. Will not drip or run on vertical surfaces. -200°F to +275°F. Uses: Chains, gears, drives, hinges and other vertical or overhead surfaces.



ULN1036C 2oz
Silicone Lubricant



3155 2oz
Plumber's Grease Apply to faucet stems, valves, ballcocks, plungers, packing, o-rings, etc... to lubricate & prevents rust. Goes to high temperatures up to 350° F



Oils

17-132 1.5oz
Long Lasting, High Film Strength Lubricant that is safe and effective on Rubber, Metal, Wood, Glass & Plastic. Won't Wash Out, Freeze, Gum Up or Melt. Performs from -20° to 400° F.



SOQ 1qt
SOG 1gal
General Wire Snake Oil. Protects your cables better than common lubricants. Its special rust inhibitor cuts through moisture and replaces it with a rust-resistant coating. In addition, Snake-Oil gives your equipment a fresh, clean smell.



MO98 4oz
Zoom spout oiler. Quality turbine oil in a handy container for those hard to reach spots. The spout is adjustable to 14".



Graphites

75101 320g
Dry Graphite Lubricant. Ideal where petroleum products must be avoided. Resists dirt, dust, and oil build-up. Effective up to 85°F constant.



GRAPHITE 30g
Graphite Powder Dry powder keeps locks, hinges and bolts lubricated and working smoothly. Guards against sticking and dirt build up. Prevents lock outs, wear, sticking and corrosion. Great for out doors, cannot freeze.



A00204 10oz
Dry Graphite Lube, Ideal where a dry lubricant is required or where petroleum products must be avoided. Adheres with minimum pre-treatment. Effective up to 850°F constant & 1000°F intermittent. Excellent conductivity. Dries rapidly at room temperature.



Belt Dressing



A00607 10oz
Belt Dressing Conditions belts while increasing pulling power up to 50% Reduces squeaky noise Can be applied directly to belts and sheaves of "V" belts while running Authorized by USDA Contains no asphalt or rosin Will not glaze or collect dirt or dust .



Cleaners / Removers

Not available at all locations

MSTF-370
Prevents the fresh bead of silicone from spreading out as it is tooled. Fresh, new silicone is pressed very deep into the seam. Excess silicone collects on your finger & is easily transferred to a paper towel. The silicone doesn't stick to your finger!!



24 HR.



Order by **4pm** for **24-48hr shipping** to almost anywhere in Canada!

AA181200 1Lt
AA181300 4Lt
Turpentine A general purpose cleaning solvent used as a paint thinner & brush cleaner. Spot remover and degreaser. Bug and tar remover.



800615 15oz
Heavy duty paint remover. Fast acting, cuts through all paint finishes, baked or air dried. Also works on adhesives



AL012116 32oz (908g)
T.S.P from Dynamic Paint Products. All purpose heavy duty cleaner, prepares surfaces for painting



RB75 4oz
Rust Buster Fast acting and super penetrating. Quickly loosens rusted or corroded parts such as screws, nuts, bolts, valves, fittings, and other assemblies. Spout extends up to 14".



74085 8oz
Ultra-pure, non-CFC gas that removes microscopic particles of lint, dust, ferrous oxide & other contaminants. Useful on delicate components & instruments where residual entrapment could be a problem. Uses: Electronics, data processing, optical & laboratory equipment, personal computers, precision mechanical parts.



PHB19601 - 946ml
PHB19604 - 3.78Lt
Glue Buster adhesive remover. Gel formula. Removes carpet glue, black glue, construction glue, ceramic glue (on plywood), epoxy glue, latex glue, contact glue and 100% polyurethane glue. Application with roller or brush.



320550 500ml
Kwik clean brush and roller cleaner, cleans oil based paints and stains from brushes and rollers. Cleans hardened brushes, rinse clean with water



PF004806 125ml
PF002416 474ml
PF002617 650ml spray
Goof Off removes almost anything. Grease, adhesives, gum, latex paint, pen, markers, lipstick etc...



Silicones / Caulking



Best Sellers



Ready for water in just 3 hrs.



70790 White, 300ml
KwikDry technology, dries in three hours. Dap 3.0 contains Microban and is mold and mildew resistant. Permanently flexible. Waterproof seal. Paintable. Kitchen/bath adhesive caulk.



73382 White 83ml (squ. tube)
73376 White 300ml
73380 Almond 300ml
Dap Titanium Silicone II Kitchen & Bath Sealant
Provide greater strength and flexibility. Up to 50% more flexible than other silicones. Provides excellent adhesion to difficult substrates like tub surrounds (ABS), Formica,® and painted woods.



73446 White 300ml
73444 Clear 300ml
73450 Grey 300ml

73448 Almond 300ml
DAP® 100% Silicone Kitchen and Bath Sealant is a one component, acetoxy cure material ideal for caulking and sealing in kitchen and bath areas. It provides a durable, watertight seal that won't crack or shrink.



71023 White 162ml
71055 Clear 162ml
DAP Kwik Seal Tub & Tile Adhesive Caulk Bonds like a glue and seals like a caulk. Provides a durable, watertight seal. Excellent adhesion and flexibility. Tools easily. Cured caulk is mildew resistant. Paintable. Easy water clean-up.



71020 White 300ml
DAP Kwik seal bonds like a glue and seals like a caulk. Provides a durable watertight seal. Excellent adhesion and flexibility. Tools easily. Cured caulk is mildew resistant. Paintable. Easy water cleanup.



74082 White 300ml
74102 Black 300ml
74094 Brown 300ml
74106 Aluminium 300ml
74118 Clear 300ml

Indoor/Outdoor Sealant Dynaflex 230 Premium Latex Sealant. Waterproof and paintable. Outstanding durability, adhesion and flexibility with easy tooling, low odour, easy water clean up. Seals out water and air leaks & improves energy efficiency. Mold and mildew resistant. Ideal for windows, doors, siding, trim, molding and baseboards. 50yr Guaranteed.



73461 White 300ml
73497 Brown 300ml
73473 Clear 300ml
73485 Aluminium 300ml
DAP Multi-Purpose Silicone Sealant Superior quality, Offers long-lasting flexibility and excellent adhesion. Provide a weatherproof, watertight seal. Resists cracking, crumbling and chalking. Interior/exterior use. Great for windows and doors. 50yr Guarantee.



73358 Clear 83ml (squeeze tube)
73352 Clear 300ml
73350 White 300ml
DAP Titanium Silicone II Window and Door Sealant. Up to 50% more flexible than other silicones. Provides excellent adhesion to difficult substrates like painted woods and window PVC. Extreme weather applications (from -37°C to 60°C).



73635 White 300ml
DAP Alex Painters Caulk All purpose acrylic latex painter's caulk. Applies smoothly and easily. Adheres to wood, plaster, drywall and masonry. Resists cracking and chalking. Interior/exterior use. Paintable. Water clean-up. 25yr Guarantee.



74225 White 162ml
74233 White 300ml
74235 Clear 300ml
74247 Almond 300ml
74245 Brown 300ml
74239 Grey 300ml
DAP® ALEX PLUS® Acrylic Latex Caulk Plus Silicone. Superior quality, multi-purpose. Highly flexible and durable. Excellent adhesion. Mildew resistant. Interior/exterior use. Paintable. Water clean-up. 35yr.



8160002 White 300ml
8150002 Clear 300ml
Gorilla 100% Silicone Sealant. Ready for water exposure in 30 mins. Mold & mildew resistant. Won't yellow, shrink, or crack.



New!



786DC Translucent White 300ml
Bath & Kitchen Silicone Dow Corning® Silicone Sealant is designed to seal nonporous surfaces around showers, tubs, sinks and plumbing fixtures where conditions of high humidity and temperature extremes exist. Tubes



78351 Clear 300ml
Dap Draft Attack Removable Sealant
Unique weather-strip caulk provides a watertight and weather-proof seal. Seals out drafts and moisture. Peels away easily when removal is desired.



74816 Grey 300ml
DAP Polyurethane Waterproof Concrete Sealant. Professional-grade sealant specially formulated to fill and seal cracks and gaps in concrete, mortar, masonry, and stone. Textured. Permanently flexible. Paintable.



Sealants

73366 Gray 300ml Concrete & Masonry Our best 100% silicone sealant specially formulated to fill and seal cracks and joints in concrete, mortar and masonry. Extremely durable and flexible. Waterproof, water-tight seal. Paintable. Water clean-up. Concrete gray colour



30901-1 Limestone, 300ml PL Polyurethane Concrete & Masonry. Formulated for all concrete, masonry & brick applications Conforms to CSGB CAU2-19 13-M87



74810 White 300ml DAP Polyurethane Waterproof Window & Door Adhesive Professional-grade adhesive sealant that provides a permanently flexible, waterproof seal. Provides an extremely strong bond to a variety of surfaces. 50 Year Durability Guarantee.



30765-0 Clear 300ml LePage Draft Stop A transparent, temporary sealant ideal to use around windows, doors, air conditioners, baseboards and wall outlets. Apply in Fall and remove easily in Spring. Paintable. Weatherproof.



71064 Gray 300ml Fire DAP Stop Fire-Rated Silicone Sealant Meets ASTM E 814/UL 1479 and UL 2079 specifications. Classified for sealing fire-rated, non-combustible service penetrations and construction joints in horizontal and vertical fire separations. Elastomeric - capable of +-25% dynamic joint movement



KK0205 304ml Imperial Hi-Temperature Silicone Sealant, Red. Flexible waterproof silicone sealant. Use on metal, glass, wood and plastic Resists temperatures up to 316°C (600°F)



SC13111 Regular, 7/8" x 11'
SC13121 Wide, 1-1/2" x 11'
Tub n'Wall to seal between bathtub and wall. Available in 3 widths. 11' length for easy application on 1 tub. White



SC20011 1-1/2" x 11' Tub caulk coverup, self adhesive, waterproof, Easy to install: Peel, cut and stick, No more mildew, tested over 3000 shower period and no mildew! Perfect size for 1 tub. White.



SC13131 1-1/4" x 5.5' Tub n'Floor To seal between bathtub and floor. Made in one size to perfectly fit standard 5' tubs. White

74200 Tan, 340g
74202 Tan, 680g

Dap Kwik Foam Insulating Sealant moisture-cure, polyurethane foam insulation that expands to economically fill and seal large cavities. Stops air infiltration and will not degrade or shrink. Contains a flame retardant and meets Montreal Protocol 1987.



71062 White, 340g **Daptex Latex Foam Sealant** Fills, seals, and insulates cracks, gaps, and voids around windows, doors, pipes, vents, outlets, foundations, and crawl spaces. Keeps heat in and drafts, moisture, and pests out. Easy-to-use latex foam won't over-expand and cleans up with water.



TNF12 12 oz
TNF20 20 oz
Maximum expanding formula, in the familiar green can, is the original Touch 'n Foam sealant formulated to fill gaps and voids all around the home. This super-expanding foam creates an airtight, weather-resistant bond that seals out drafts while blocking insects and other pests.



TNF-MIN 12 oz
Touch 'n Foam HomeSeal Minimum Expanding Sealant is an all-purpose foam that can be used for both indoor and outdoor applications. This foam will not expand as much as the MaxFill expanding formula, so it's better suited for smaller cracks and voids.



TNF-FIREBREAK 16 oz **Fireblock Foam Sealant** Easy-to-use fire block* foam sealant that's ideal for DIY-ers and small contractor jobs. Independent testing confirms that FireBreak resists flaming twice as long as the competition and prohibits oxygen flow into service penetrations where fire may quickly spread.



Caulking Guns



C001464
9" Heavy Duty Skeleton Frame Caulking Gun. Stop drip action can be turned on or off instantly. Hexagonal rod. Built-in seal punch and tip cutter.



AJ2000CG
9" Caulking Gun. Smooth rod, Sturdy cradle for easy loading, Built-in seal punch and tip cutter.



AJ200126
9" Heavy Duty Caulking Gun. Sturdy cradle for easy loading. Ratcheting rod prevents slippage. Built-in seal punch and tip cutter



AJ200118
9" Professional Grade Skeleton Frame Caulking Gun. Heavy duty frame for extra strength, Easy loading. Built-in seal punch and tip cutter.



Fillers / Spackling



30070 White 5.5kg
For smooth, quality finishing of gypsum panel joints. Easy to use, ready mix formula is easily applied, has minimal shrinkage and sands easily.

We carry **100's of Tools** to help with any installation or repair projects!

Visit us online!

www.amresupply.com



26633-4 900 ml
LePages polyfills Prep wall paint prep, Fine Surface Filler. Ready-Mix fine surface filler & spackling compound. Smooths surface imperfections and fills shallow cracks and holes.

26638-0

26643-1



26638-0 162ml
26643-1 900ml
Poly Instafil Lightweight Spackling Compound. Ready to use - Ideal for filling cracks and small holes. Ultra-smooth, lightweight, ready-to-use spackling compound that smooths surface imperfections. Minimal shrinkage; sandable and paintable. Interior and exterior use

LEPAGE

00590-0 162ml
Exterior Wood Filler. One fill, no shrinkage, sandable and stainable. Can be sawed, drilled, cut, nailed and screwed. Water and mildew resistant. Dries to match most light coloured woods.



LEPAGE

00493-0 90ml
Wood Filler A high quality latex based indoor wood filler for fixing cracks, holes and surface imperfections. Cabinet Maker's Quality. Sandable, paintable. Non-flammable, solvent free; low odour. White Paintable.



71162 Bright Pink, 237ml
71164 Bright Pink, 946ml
DryDex spackling contains a patent-pending Dry Time Indicator causing the product to change color when optimum dry time is achieved. It goes on pink and turns white! Easy to use indoors and outdoors on drywall, plaster, wood, and more.

LEPAGE

26695-2 3L
Poly Stipple Light textured stucco. Pre-mixed, applies easily with a roller, gives a professional finish to walls & ceilings in one easy step. Unlimited patterns can be achieved with a variety of tools. May be pre-tinted or painted.



LE002065 2" x 65'
Tape n' Fix Drywall joint tape and wall repair. Self-Adhering. Repairs damaged drywall and plaster professionally. Fiberglass mesh won't tear, shrink, stretch or bubble



60584 White 946ml
Dap Stucco Patch
Ready to use professional quality for repairs in stucco and textured surfaces. Durable and permanent. Easy to tool and paint.

LEPAGE

52086 White 946ml
A ready mix plaster patching compound for everyday household repairs to surfaces such as plaster and drywall. Dries to a hard finish with minimal shrinkage. For interior use only.



LEPAGE

42020-1 White 900ml
Premixed Tile Grout specially formulated, water and stain repellent, one-part grouting compound. For both new tiling and for re-grouting tiles and fixtures. Ready to use. Siliconized for enhanced performance under humid conditions. Fast setting and durable. Dries hard in 24 hours.



SC10004
Heavy Duty Caulking scraper, rubberized handle for better and more comfortable grip, tough, stainless steel blades



SC10123
Caulking Tool Kit Comes with finishing tool, flexo tip applicator and scraper. Makes caulking quick, easy & clean. Ergonomic high quality tools.



SC10002
Caulking Applicator Reusable high quality tool to assist with the messy job of applying silicones & caulking. Multi-sized 2 sided tips, Rubber grip.



SC10003
Caulking Flexo Tip Applicator Works on all standard caulking guns, makes caulking quick, easy & clean.



SC10001
Caulking Scraper does not scratch, rubberized handle for better grip, double sided helps the removal of silicones and caulking.



**Contractor
10/pk**



DP3295195 Brush Nickel
1-1/4" (32mm) Dia Metal knob, 8/32" screws included



DP2391132195 Brush Nickel
1-1/4" (32mm) Dia Metal knob, M4 screws included



DP4443195 Brush Nickel
1-1/4" (32mm) Dia Metal knob, 8/32" screws included



Check out **100`S** of knobs & pulls
all styles and designs to fit any decor!

**Contractor
10/pk**



DP3511195 Brush Nickel
3-3/4" (96mm) value 10 pack brush nickel pull handle with 8/32" screws included



DP33203195 Brushed Nickel
3" Metal Pull. 30mm projection, 8/32" screws included.



DP65076195 Brushed Nickel
3" Metal Pull. 27mm projection, 8/32" screws included



DP7814195 Brushed Nickel
96mm Metal Pull, 126mm overall length, 8/32" screws included

We carry a **wide selection of fasteners!**
All types and sizes!
For any job!
www.amresupply.com/hardware

The original, the best, stick to it!

*Feltac floor saver felt pads.
Premium quality glue injection technology*



Part #	Description
23109	3/4" Round self adhesive 24/pk
23125	1" Round self adhesive 16/pk
23169	1-1/2" Round self adhesive 4/pk
23102	1-7/8" Round self adhesive 4/pk
93054	Multi-size self adhesive, round/strips/sheets 33/pk
23100	4.5" x 6" self adhesive pads, can cut to size 2/pk
23190	1-1/2" x 1-1/2" Corner self adhesive 8/pk
23107	1/2" x 60" Roll, cut to size self adhesive 1/pk
23120	3/4" Screw on felt pads 8/pk

See our website for full selection of fasteners www.amresupply.com





Keyed alike

3008D 1-9/16" 4Pk
Masterlock 3008D padlock 4 pack keyed alike. Laminated steel.



ML-312D 1-9/16" Wide
ML-312TRI 3pk Keyed Alike
Outdoor protection against dirt, moisture & grime, high-tech thermoplastic shell, laminated steel & hardened steel shackle with moulded cover, matching keyhead



140D 1-1/2"
P002300 2"
P002610 1-1/2" 2/pk
Keyed alike
Brass Padlock. Solid brass with hardened steel shackle



ML-7D 1-1/8" Wide
ML-1D 1-3/4" Wide
ML-5D 2" Wide
Laminated steel body for superior strength • hardened steel shackle for extra cut resistance • 4-pin cylinder helps prevent picking • dual locking levers provide extra pry resistance



ML-1DLJ 1-3/4" Wide
ML-1TRILJ 3pk Keyed Alike
Laminated steel body for superior strength • hardened steel shackle for extra cut resistance • 4-pin cylinder helps prevent picking • dual locking levers provide extra pry resistance



ML-1500D
MasterLock Combination Padlock. Hardened steel shackle. 3 digit dialing. 1-7/8" durable metal body. Worlds best selling padlock.



ML-78DPF 6' (72")
MasterLock Looped end cable. 3/8" diameter. Braided steel for superior strength. Protective vinyl coating.



ML-3025AT 12pc
MasterLock Bungie Cords. Reverse hook, twin wire allow more room to attach. (2) 6", (3) 18", (2) 24", (1) 32", (1) 40", (3) mini



R001520 1/4" x 50'
Poly Rope. Diamond braid, reflective, weather resistant, polypropylene, floats, reusable winder.



R000904
Ratchet Tie Down. 1" x 15', 1000lb rated. Vinyl coated hooks.



L003162
Ratchet Tie Down. 2" x 20', 2000lb rated. Vinyl coated hooks



301XB Steel
301FBV Black
Latch & Strike kit
Gate Latch Kit. Constructed of rough steel. 2" x 1 1/2", Kit or arm only come complete with screws



925CXB 4"
926CXB 6"
927CXB 8"
Life-span heavy tee hinge, exclusive bearing design eliminates metal on metal contact, smooth quiet design, zinc plated



921CXB 4"
922CXB 6"
923CXB 8"
924CXB 10"
Life-span heavy strap hinge, exclusive bearing design eliminates metal on metal contact, smooth quiet design, zinc plated



316XV
4-1/2" plain hasp.



37-3550 3-1/2"
Swivel hasp.

24 HR.



Order by
4pm for
24-48hr shipping
to almost anywhere in
Canada!

- | Part# | Size |
|---------------|--------|
| 97X10B | 1" |
| 97X15B | 1-1/2" |
| 97X20B | 2" |
| 97X25B | 2-1/2" |
| 97X30B | 3" |
| 97X40B | 4" |
| 97X50B | 5" |
| 97X60B | 6" |
- L-Brackets



H007770

H007770
3pc Jumbo Hook Set
H004797
10pc Hook Set
Screw on multi-use hooks. Screws included. 10pc includes 4 different styles.



H004797



020075 Black
030098 White
Residential grade mailboxes, horizontal



STURDY LADDER INC. **A428 Series GRADE 2**



- A428-03 3'
 - A428-04 4'
 - A428-05 5'
 - A428-06 6'
 - A428-08 8'
 - A428-10 10'
 - A428-12 12'
- A-428 Series - Aluminium step ladder. Medium duty, type 2, 225 lbs rated, solid rivet construction, positive locking pail shelf

STURDY LADDER INC. **A534 Series GRADE 1A**



- F534-16 16'
 - F534-20 20'
 - F534-24 24'
- Fiberglass extension ladder, CSA Grade 1, ANSI Type 1A, 300 lb. rated. Non-conductive fiberglass rails. Solid rivet construction. Heavy-duty self-aligning safety feet with slip resistant threads and steel ice pick plate. Heavy-duty aluminium pulley. 1-5/8" aluminium "D" rungs with serrated surface for safety and comfort. Rungs attach directly to rails using protective washers

STURDY LADDER INC. **F-540/486 Series GRADE 1**



Grade 1	Grade 1A	Ht.
250 LBS	300 LBS	
Yellow	Red	
-	F486-03	3'
F540-04	F486-04	4'
F540-05	F486-05	5'
F540-06	F486-06	6'
F540-08	F486-08	8'
-	F486-10	10'
-	F486-12	12'

Fiberglass step ladder Industrial, CSA Grade 1, ANSI Type 1, 250/300 lbs. duty rating. Non conductive fiberglass rails. Solid rivet construction.



STURDY LADDER INC.



- 786** 6' step/9' extension
 - 788** 8' step/13' extension
- Multi-way Ladder. Exceptional strength, stability and rigidity. Use as a step ladder, trestle, stair-way or extension ladder. 225lb rated



STURDY LADDER INC. **130 Series**



- 130-02 2'
 - 130-25 2.5'
 - 130-03 3'
- 130 Series - Aluminium saw horse "Mustang", heavy duty aluminium extrusion, double solid rivet construction, non slip feet.



- S011840** 2 Step steel ladder, sure foot, wide, non slip steps. 150 lbs capacity. Heavy duty strength



- S011845** 3 Step steel ladder, sure foot, wide, non slip steps. 330 lbs capacity. Heavy duty strength



- Barricade tape, 3" x 1000'
- | PART# | DESCRIPTION |
|---------------|---|
| CT3RE8 | DANGER Do Not Enter- red, pkg. in dispenser box |
| CT3RE9 | DANGER- red packaged in dispenser box |
| CT3YE1 | CAUTION- yellow, bulk packaging |
| CT3YE2 | CAUTION Do Not Enter- yellow, bulk packaging |



- SDN089** 2" x 60' GatorGrip black and yellow safety anti-skid tape. Premium grade. Other sizes and styles available on request



- CZ91441** 1" x 60ft
 - CZ91442** 2" x 60ft
 - CZ91444** 4" x 60ft
- Anti-skid safety tread tape. Self adhesive. Black



Outdoor Equipment



2090-RED
2090-BLACK
2090-BLUE
2090-GREEN
2090-YELLOW

Surf Bike Rack. All metal welded construction, super durable polyester powder coating, easy installation, 32"W x 25.75"H x 27.75"D



2080-RED
2080-BLACK
2080-BLUE
2080-GREEN
2080-YELLOW

Linguini Bike Rack. All metal construction, super durable polyester powder coating, easy installation, unique design part of family of integrated products. 45"W x 35.5"H x 3"D



2070-RED
2070-BLACK
2070-BLUE
2070-GREEN
2070-YELLOW

Bike Stop. All metal construction, 2 ring design, square tuber deters use of pipe cutters, surface or embedded concrete mounting. 12"W x 36"H x 4.5"D



4' Long
2040-RED
2040-BLACK
2040-BLUE
2040-GREEN
2040-YELLOW

6' Long
2060-RED
2060-BLACK
2060-BLUE
2060-GREEN
2060-YELLOW

Stream Bench. All metal heavy gauge construction, built-in arm rests, Ergonomic with lumbar support. 2040 is 38"W x 34"H x 25"D, 2060 is 72"W x 34"H x 25"D.



S-15585



S-20825



H-1662

H-2897

H-3491



H-1662 8ft. U-Channel Galvanized Post
H-2897 Dispenser
H-2898 Sign
H-3491 Receptacle
S-15585 10 x 200 Pickup Bags
S-20825 4 x 50pk Trash Liner Bags

Dogipot Pet Waste Station. Economical and practical to motivate pet owners to clean up after their pets. See website for full specs.



Check out the AMRE website for our full selection of Winter seasonal products!

www.amresupply.com/seasonal

- Ice Melters
- Snow Shovels
- Heated Gear
- Sand & Salt Bins
- Spreaders and more....





OS-91143
Oscillating Sprinkler with wide sturdy metal base. 3,600sqft coverage, 21 jet nozzles, 72 position spray control dial



OS-91142N
Oscillating Sprinkler with wide poly base. 3,400sqft coverage, 19 jet nozzles, easy click feature



OS-91633
Commercial Grade Pulse sprinkler, zinc spike head, covers up to 85' dia., adjust full or part circle, anti-backsplash arm, deflector, can connect in series.



OS-56053N
Contractor grade spray nozzle. Brass with rubber grip.



N000577
7-Way Aqua Gun. Strong ABS body with fiberglass lever handle and comfort grip, lock clip, 7 patterns from jet to mist.



OS-91642
Commercial Grade 7-Function Aqua Gun, high impact metal construction, self cleaning turret, insulated soft hand grip, soft dial turret guard, professional design.



OS-91635
Brass tip pistol nozzle. High impact zinc & brass construction non-corrosive exterior brass adjuster nozzle with tip protector insulated soft hand grip



OS-56337N
Commercial Grade Front Trigger with lock on and release, brass nozzle large rubber adjustable knurl



N000510
Soft Grip Aqua Gun, 5 1/2", brass stem, adjustable screw, lock clip, pvc soft clad insulated finger grips, threaded front



N000603
Economy Nozzle, 4", fully adjustable from mist to jet, solid brass twist nozzle.

Don't forget to login to see wholesale pricing

www.amresupply.com



W000080
Watering Can. 3 Litre, all poly, ergo handle for 2 hand placement and balance.



N000435
Inline garden hose shut-off. Zinc. Female x male garden hose thread.



N000335 Zinc
202-WV Brass
"Y" Hose Shut Off, 2 shutoffs. Large levers. Turn 1 faucet into 2.
ULN530 No Shutoff



ULN531RW Washer, 12/pk
18-066 Screen Washer
Hose Washers. Deluxe 100% rubber quality washers to fit all garden & wash machine hoses.



2323-B
3/4" Female Cap & Washer

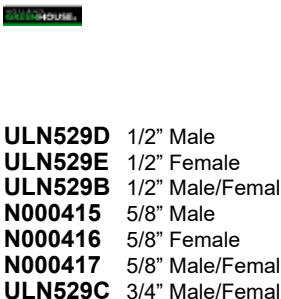

ULN529D 1/2" Male
ULN529E 1/2" Female
ULN529B 1/2" Male/Female
N000415 5/8" Male
N000416 5/8" Female
N000417 5/8" Male/Female
ULN529C 3/4" Male/Female
Solid Brass hose repair couplings, grooved tangs, c/w stainless steel clamps. To fit 1/2" or 5/8" ID garden hoses. Cap is standard garden thread c/w vinyl hose washer.



N000425 1/2" - 5/8"
N000425L 5/8" - 3/4"
Hose Mender



ULN529A
3/4" Female Hose x 1/2" MIP
Solid Brass Adapter



complete line of seasonal products for all seasons! www.amresupply.com/seasonal

Hardware





N000355 Male
N000349 Female
 Quick connect garden hose adapters. Male or female x quick connect.



OS-58117N
 Brass quick connect set



N000343
 Quick Connect Female Adapter.



N000340
 Quick Connect Male Adapter.

New!



SM-72053 5/8" x 50'
 ROK Flexinator Hybrid Hose. Lightweight and Flexible PVC. Stays Flexible in Cold Weather. Kink Resistant and Easy to Coil.

swan
Good



New!

HH58050 5/8" x 50'
HH58100 5/8" x 100'
 Heavy Duty Garden Hose. Crush resistant brass couplings. Weather and abrasion resistant.

swan
Better



New!

HC34050 3/4" x 50'
HC34075 3/4" x 75'
 Commercial Grade, Heavy duty rubber/vinyl reinforced, premium 5-ply, spiral knit dual reinforced for kink resistant

swan
Best



New!

H-CELSGC58050 5/8" X 50'
H-CELSGC58100 5/8" X 100'
 Super G Rubber Hose
 The latest technology in rubber hose. 30% to 50% lighter. 30% longer life in the sun and drinking water safe



H-ELTECV025 25ft
 Element Flat Soaker Hose. Vinyl 3 tube. Good for narrow areas. Eco-safe, capped male coupling.



H-ELSP38050 50ft
 SoakerPro Soaker Hose. Slow soak, 0.5-1gal per hour, great flexibility, 65% recycled material, eco-safe

AMES



23-841
 Deluxe Poly Hose Hanger, 6" x 13-1/4" x 10-3/4", slotted shelf for hose sprayers, holds 150' 5/8" hose

SWANHOUSE



H008690
 Steel Hose Hanger. Enamel and ribbed for strength. 10" x 5-1/2" holds up to 200ft of 1/2" hose.

New!



23-883
 Side Mount Hose Reel. Easy wind and store. Leader hose included. Holds up to 100 feet of 5/8" hose or 150' of 1/2" hose.

AMES



G-23855NL
 NeverLeak Reel Easy Hose Reel Cart. Folds down for compact storage. Leader hose included. Holds up to 175' x 5/8" hose.

FORT



FORT-TK100 6 cu.ft.
 Wheel Barrow, Poly. Deep tray of U.V. stabilized virgin polypropylene. Cap. 100L wet / 6 cu.ft. dry. 1-pc bent frame without welds 1-1/4" dia. tubing.



W000429 6 cu.ft.
 Steel Tray Wheelbarrow, 6 cubic feet. 14" Flat Free Tire, 60" wood handles



S010590G
 Hand Spreader. 6lb capacity. 6'-8' spread pattern. 1000 SQ.FT.

PRO PICK



S010582
 All season spreader, 125lb capacity
 - Perfect for icemelt, fertilizer, seeds, rock salt and more
 - Stainless steel hardware, axle and shaft
 - Fingertip flow control
 - Heavy duty nylon gear
 - Rust resistant hopper
 - 14" Pneumatic tires

SWANHOUSE



S010580
 Greenhouse broadcast spreader. 60lb (27.2kg) capacity, HD nylon gear, 10'-12' spread radius, handle flow control, rust resist powdercoat finish





15-544
9-5/8" x 11-1/2"



15-540
6-7/8" x 12"

Square Head Garden spade with "D" handle, 29" premium wood handle, Open back tempered steel blade



15-545
Square head garden spade with 47" premium stained wood handle
Tempered steel head
9-5/8" X 11-1/2"



15-546
Round Mouth Shovel with "D" handle, 29" premium wood handle, Open back tempered steel blade, Poly power "D" grip, 8.5" x 11.5"



15-543
Round Mouth Shovel with Long 46" premium Hardwood Handle, open back tempered steel blade, forward turned step, Blade size is 8 1/4" x 11".



G-TBPG12D
Poly Scoop
Grain scoop, 30 1/4 in., 14 1/2 in. blade heavy-duty. Lightweight



18-501
Garden Hoe. 48" hardwood handle. Blade size is 6 1/2" x 4", Welded, Medium duty for all your general purpose needs.



19-260
22", 24 Tines
R000226
26", 27 Tines
Extra Wide Poly leaf rake. 48" hardwood handle. Ribbed construction for extra strength. Strong flexible poly tines. 5yr limited warranty.



R000200
22", 22 Tines
Steel spring brace rake. 48" hardwood handle. Bolt through handle assembly.



18-816
Bow Rake with 54" Hardwood handle, 14" head, 14 tines, welded head, plastic ferrule.



R000180 24"
Landscapers Rake. Powder coated aluminum handle, 5"H head with 2-1/4" non-gouging teeth and 1-1/8" striking edge, 66"L handle, heavy duty,



W-9258
10" Sliding Saw. Triple ground teeth cuts on push and pull stroke. Heavy duty and light weight. Built in belt clip.



W-9041
28" ByPass Loppers 1-3/4" cut capacity, forged steel blade w/steel handles, cushion grip



W-9112
Bypass Pruner. 5/8" capacity. Non-stick coated carbon steel blade. Easy thumb lock



W-9286
23" Powergear Hedge Shear. 10" blades, shock absorbing, 3x more power on every cut, steel construction



ARC32 32"
E-Z Reacher for sanitation workers, homeowners, cleanup teams, gardeners, livestock handlers, grounds maintenance crews, and hospital cleaning personnel



P005750 30"
Save backache from bending over to pick up garbage etc. The suction cup rubber ends will grab onto any shape & size of object.



PUW02100 40"
Cleaning public areas and garden, washing urinals and toilets, collecting industrial products and waste. Light compression of handle to give maximum gripping pressure.



SC-AB5 5L (1.25Gal)
SC-AB10 10L (2.5Gal)
SC-AB20 20L (5.3Gal)
Scepter Self Venting Gas Cans. Child resistant closure cap, vented spout design

Will fit only Scepter brand cans



SC-JCA4
Scepter gas can replacement spout, gasket, collar and cap.



SC-F174
Scepter Multi-Use Funnel. 6.3"L x 5.3"W x 16.5"H





WINTER ESSENTIALS
 Do you use large volumes of icemelt?
 Ask about our truckload pricing!

Tip: Properly store ice melt.

Open bags of ice melt should be stored in airtight containers and kept away from moisture, air, and sunlight. Completely seal bags/containers as exposed ice melt will absorb moisture causing the product to degrade, clump, and harden.



**Buy "50 Bag" Pallets!
 Deal pricing!**



**Be ready for winter!
 Keep sidewalks clear!**



**09017
 20 kg bag**

**effective
 up to -22 C**



- Generates heat as it dissolves ice
 - Green marker dye reduces over-application
 - Each granule is coated w/Calcium Chloride brine
- Calcium Chloride – the best Ice Melter ingredient – for speed and duration in ice melting.**



**09002
 20 kg bag**

**effective
 up to -31C**



- Generates heat as it dissolves ice
 - Re-sealable bag
 - INDIGO™ marker dye reduces over-application
 - Will not harm vegetation, concrete or pets (use as directed.)*
- Calcium Chloride – the best Ice Melter ingredient – for speed and duration in ice melting.**



S010590G
 Hand Spreader. 6lb capacity.
 6'-12' spread pattern.



S010580
 Greenhouse broadcast spreader. 60lb (27.2kg) capacity, HD nylon gear, 10'-12' spread radius, handle flow control, rust resist powdercoat finish



S010582
 All season spreader, 125lb capacity
 - Perfect for icemelt, fertilizer, seeds, rock salt and more
 - Stainless steel hardware, axle and shaft
 - Fingertip flow control
 - Heavy duty nylon gear
 - Rust resistant hopper
 - 14" Pneumatic tires

**Prevent slips
 and falls!**



MY-12201
 Ice Cleats.
 Aggressive spike helps prevent dangerous slips and falls, one size fits most, durable material for long lasting effectiveness.



Salt & Sand Bins
 30"L x 24"W x 24"H
SOS5.5GY Grey 500lb
SOS5.5YE Yellow 500lb

SOS11GY Grey 1000lb
SOS11YE Yellow 1000lb
 42"L x 29"W x 30"H

Sand/Salt Bins have a double wall lid and moulded in hasp to keep contents dry & secure. Heavy-duty construction. Water tight and impact resistant





G-NSP24D 24"
Nordic Steel Pusher.
Blade 10" 40-1/4" hardwood
handle with poly 'D' grip for
strength and moisture resistance.



S005992
Aluminum Scoop. Blade size 13" x 17-3/8" alum
blade. 28-1/4" ash hardwood handle



G-TBPG12D
Poly Scoop
Grain scoop, 30 1/4 in., 14 1/2 in. blade heavy-
duty. Lightweight



G-YPP24SAKD 24"
Snow pusher aluminum handle straight
lightweight, 24 in. poly blade with extra support
ribs for added strength



G-YPP24EAKD 24"
Yukon Ergonomic Snow Shovel. Ergo
non-slip aluminum handle. Extra blade
support ribs for strength



Ergo Handle!

G-YPP36KU 36"
Yukon 36" Extra Wide Snow Pusher.
Lightweight strong tubular steel

Visit our
website
for our full selection
of heaters
www.amresupply.com

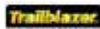

G-TBPP21KD 21"
G-TBPP26KD 26"
Snow Shovel, yellow poly blade hardwood
handle



G-TBPP21KDR 21"
(w/wear strip)
Snow Shovel, 21", yellow poly blade with a
galvanized steel wear strip



MY-996-27 27"
Snow Brush w/ Scraper

G-YFSW9 9" (Extra Heavy Duty Industrial)
G-LHSW7 7" (Medium duty)
Steel Ice Chipper, 48" varnished hardwood handles for
strength and moisture resistance. Industrial has forged
and tempered steel blade. Medium Duty is stamped &
tempered steel blade. Industrial by Garant.





10024 369g
10936C 3.78L
Kilz Original
Blocks out most stains, primer, sealer and stainblocker. Sands easily. For use on interior surfaces



10314 369g
Kilz Odourless
Fast drying stainblocker primer. Ultra low odour formula, for use on most interior surfaces



10027S 284g
Kilz UpShot
Unique interior stain sealer that has vertical spray tip for easy ceiling application. Dries fast and is tinted to match most aged acoustical ceilings



68941C 3.78L
Kilz Ceiling Paint.
Unique combo of stainblocking and a coverage / dry time indicator. Rolls on easy with minimal spattering and subtle pink colour that dries to white. Interior use.



19941 3.78L
Kilz Premium.
Superior quality, fast drying, water based primer, sealer and stainblocker. Excellent adhesion and mildew resistant coating. Idea for moisture prone areas. Interior and Exterior



29941 3.78L
Kilz 2 Latex
Fast drying, water based multi-purpose primer, sealer and stainblocker with a mild odour. Blocks out most stains. Interior exterior use.



59941 3.78L
Kilz General Purpose.
An interior fast drying latex primer and sealer. Ready to spray brush or roll, can be top-coated with latex or oil based paint.



Appliance Epoxy
43201 White
Krylon® Appliance Epoxy is perfect for updating & coordinating household appliances. The stain, scratch, & fade-resistant formula protects surfaces for years.

General Purpose

Not all sku's stocked at all locations

- 41501** Glossy White
- 41502** Flat White
- 41508** Semi Gloss White
- 41506** Almond
- 41601** Glossy Black
- 41613** Semi Flat Black
- 41602** Ultra Flat Black
- 41608** Smoke Gray
- 41806** Sun Yellow
- 42108** Banner Red



Krylon® Decorator Paint is a fast-drying lacquer spray that creates a smooth, professional finish on metal or wood objects. Great for use on: Fences, Furniture, Cabinets, Bicycles and *Popular choice for appliances.

Fluorescent Paint

Not all sku's stocked at all locations

- 43101** Red Orange
- 43102** Yellow Orange



- Glows under ultraviolet (black) light
- For best results, use over a white basecoat.
Great for use on: Sporting equipment / Accenting safety hazards / Displays / Posters / Floral and festive ornaments / Stencils

Other colours available check our website or give us a call!



- | Part# | Colour | O.E.M. Match |
|-------------|-------------|---------------|
| BS-1 | Basic White | All Mfg. |
| AS-1 | White | American Std. |
| CA-1 | White | Crane |

Porc-a-Fix® is the only porcelain repair product with specific colour matches to the major manufacturers. **Tubs, sinks, toilets, washers, dryers, kitchen appliances and tile.** This includes porcelain on steel, cast iron or clay (ceramic). 1/2 oz.

Pavement - Striping Machine & Line Striping Paint



New!

Z-602
Striping Machine Engineered & designed for easy operation & durability. 6-can storage. Stripes widths of 2" to 4".

Great for use on: Parking lots, Warehouses, Plants, Factories, etc. and uneven surface



New!

Z-606
Striping Wand
Use for easy stencilling or line touch-ups, durable construction



New!

1101020
Reusable Letter & Number Stencils. 4" tall. Includes 0-9 and A to Z.



New!

20-786 Highway Yellow
20-782 Highway White
20-789 Handicap Blue
K08304 Coverup Black
Line Striping Paint. Durable, Nonclogging, inverted painting ease. 250' per can, 4" wide stripe Great for use on: Paved surfaces / Dirt / Grass / Concrete





HB250004 38mm (1-1/2")
HB250005 50mm (2")
HB250007 75mm (3")
 "Ovation" Flat
 Excellent quality sashes. 100% polyester. Blended gold & white. Plastic handle



HB223704 38mm (1-1/2")
HB223705 50mm (2")
HB223706 64mm (2-1/2")
 "Ovation" Angle
 Excellent quality sashes. 100% polyester. Blended gold & white. Plastic handle



HB181804 38mm (1-1/2")
HB181905 50mm (2")
HB182006 64mm (2-1/2")
 "Dyna-Flo" Angle
 Polyester/Nylon blend provides premium performance in both oil-based and latex paints. Stainless ferrule, wood handle, firm head.

100% Bristle



HB160003 30mm (1-1/4")
HB160005 50mm (2")
HB160007 75mm (3")
HB160010 100mm (4")
 "Scout" Flat
 Economically priced flat sash brush, plastic handle, steel ferrule, mixed China bristle, for all oil and alkyd-based paints



HB180004 38mm (1-1/2")
HB180005 50mm (2")
HB180007 75mm (3")
HB180010 100mm (4")
 "Colt" Flat
 Great priced popular choice 100% Bristle. Black China bristle naturally tapered & flagged. Plastic handle.



HB285003 1"
HB285005 2"
HB285007 3"
HB285010 4"
 "Foam" High Density
 High density with bevelled end. Leaves no brush marks or loose bristles. Wooden handle.



HB001502 1/2"
 "Acid Swab" black bristle brush with tin handle. Use for applying glue, cleaners, industrial products, solder flux and more.



ULN1127
 1" ABS cement brush



FA004107
 5 In 1 Painters Tool
 High carbon steel full tang blade. Black poly handle. Paint roller cleaner, crack cleaner, paint can opener, scraper & spreader

FA004101 38mm (1-1/2")
FA004102 50mm (2")
FA004103 75mm (3")
FA004104 100mm (4")
FA004105 125mm (5")
FA004106 150mm (6")
 Flexible Putty Knives Professional quality, plastic black handle, full tang



03250
 Wire Brush. 1" Carbon steel wire brush with scraper, 5" shoe handle, 4x16 rows



03255
 Wire Brush. 1" , easy-grip handle brush, 4x18 rows

Trays



W000776
 3 Pce. small plastic handle wire brush set



HB021847 3pc Lint Free Kit
 "Lint Free" Roller Kit. For all latex, acrylic and flat oil paints on smooth and semi-smooth surfaces. c/w 13mm x 240mm lint free roller, 5-wire pro cage frame and 2qt plastic tray.



HB021703 10mm x 240mm
 10 Pce. multi kit, roller/cage frame/ plastic tray with legs/tray liner/2" angle sash brush/plastic drop sheet/trim roller/can opener/gloves and utility knife



HM005303 3pc Kit
 "Mini-Foam" Roller Kit
 Contains 12" long handle with 100mm (4") foam refill and 100mm (4") solvent resistant plastic tray.



HZ020101 2qt
 Professional Liner, Clear form fitting liners



HZ020440 100mm (4") Tray
 "Mini" Roller Tray
 100mm width for small rollers. Enviro tray made of 100% recycled material. No liner required. Solvent resistant. Economical choice.

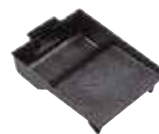

HZ020400
 2qt Reg. Tray
HZ020576
 2qt Reg. Liner
 "Regular" Tray & Liner
 Solvent resistant poly tray with brush holder and ladder lock legs. Clear form fitting liners. 240mm (9-1/2") Width, 2Lt



HB021737 3pc M.Purp Kit
 "Multi-Purpose" Roller Kit
 Economical kit c/w multi-purpose 10mm x 240mm roller, cage frame & 1qt plastic tray.





HB021744 240mm (9-1/2")
"Consumer" Roller Cage
5-wire for better roller refill grip.
Light weight and easy to hold for
everyday painting.



HB021740 240mm (9-1/2")
"Bow Frame" Roller Cage
Bow constructed 5-wire cage
preventing roller slippage. Poly
threaded handle with metal fer-
rule. Excellent value.



HB021746 240mm (9-1/2")
"Professional" Roller Cage
5-wire cage with heavy duty wire
roller. Poly threaded handle with
metal insert. Chrome plated 3/16"
shank with 90° bent end.



HB461729
75mm x 5mm
HB461719 100mm x 5mm
"Lint Free" Trim Roller
Professional quality lint free
trim roller with 3-wire cage.
For all latex, acrylic and flat oil
paints.



AZ480110 9'x12'
AZ460401 9' x 400' box
Plastic Drop Cloths. Easy to tape,
resist bleed through, light and
tough. High density clear plastic.

New!



B003155
Moving Blanket & Cover. 72" x 80"

New!



34125
Adjustable Tub Protector. Protect
your tub from damage while doing
repairs or painting. 14" to 16"
depth, 60"

**Visit our
website
for 1000's of products
and parts instock
www.amresupply.com**



HM005304 Roller w/Handle
HM005305 2pk Foam Refills

"Mini-Foam" Roller & Handle
Use with melamine, semi-gloss,
enamel, polyurethanes & varnishes.
Great for trim, cupboards, doors &
hard to reach areas. 100mm (4")
Foam.



HB021768 19mm x 240mm
"Slit Foam"
High density polyurethane for
painting uneven surfaces like tex-
tured stucco, blocks, bricks, ceiling
tiles. Plastic 1-1/2" dia core. For
polyurethane, varnish & oil-based
paints. 240mm (9-1/2")



HB021762 3mm (2/pk)
HB021763 10mm Pro
Foam refill urethanes rollers,
varnishes and oil paints. Plastic
1-1/2" dia. core. 9-1/2"(240mm)



HB461725 75mm x 5mm
HB461793 100mm x 5mm
"Lint Free" Trim Refills 2/pk
Professional quality lint free trim
For all latex, acrylic and flat oil
paints. Quality woven fabric. 75mm
(3") or 100mm (4")



HB021767 5mm x 240mm
HB021769 10mm x 240mm
HB021774 30mm x 240mm
"Poly-Pro"
Professional quality blended fabric.
Excellent in all paints & enamels.
Reduces matting, spattering & gives
even coverage. Plastic 1-1/2" dia.
core. 240mm (9-1/2")



HB021795 5mm x 240mm
HB021796 10mm x 240mm
HB021794 15mm x 240mm
HB021798 20mm x 240mm
"Infinity" Lint Free. Contractor
quality woven shed resistant fabric.
Plastic 1-1/2" dia. core. For Smooth
and Semi-smooth surfaces. Excel-
lent for all paints and enamels.
240mm (9-1/2")



31315 1-1/2" x 2yds
3103 1-1/2" x 5yds
3102 1-1/2" x 10yds
ULN1038 1-1/2" x 25yds
Sand Cloth 120 Grit Sandcloth with
Aluminium Oxide Abrasive Coating.
A good basic Abrasive Product for
the preparation of Copper Tubing
and Fittings for Solder



568-001 1-1/2" x 5yds
3109 1-1/2" x 10yds
Mesh Cloth Open faced 180grit cloth
is the professionals choice. Lasts
longer than sandcloth, waterproof,
cleans fast and leaves less gritty
residue.



AG662603 Medium/Fine
AG662605 Medium/Coarse
Dual Angle Sanding Sponge
Great for angled, contoured and
flat surfaces on light sanding
between coats of clear wood
finishes, drywall, mud, & hole
repairs. 4 sided



AG562601 Med/Fine
AG582602 Med/Coarse
Sanding Sponge 4 Sided. For light
sanding between coats of clear wood
finishes, drywall, mud, and hole
repairs. 4 sided.



NA121152 Super Fine #0000 (Final Finish)
NA121154 Very Fine #00 (Metal Polish)
NA121155 Fine #0 (Scouring)
NA121156 Medium #1 (Household)
NA121157 Medium/Coarse #2
NA121158 Coarse #3
Steel Wool, 12/pk



KNIVES



New!



K000469 3/pk Shopro Utility Knife Set. Snap-off blades and auto-lock

TASK



T85 18mm Auto-Lock Knife w/10 blades. Positive lock system, 10pk heavy duty double honed blades included, plastic handle and back cap

TASK



T00703 18mm Ratchet Lock Knife. Ratchet wheel lock, ultra safe, safety rear cap, 2 extra blades store inside body, heavy duty metal carriage

TASK



Extra Wide Blade
T00713 25mm Ratchet Lock Knife. Soft touch coating handle grip with special anti-slip design for additional safety, ratchet wheel lock, heavy duty

TASK



T00971 18mm Auto-Lock Rubber Grip Knife. Ergo design with soft touch rubber grips, heavy duty metal carriage, auto-lock system

TASK



T00705 18mm Auto-Lock Knife. Soft touch coating grip, 2 extra blades store inside body, safety cap prevents blade slide out, auto lock mechanism

TASK



T28B 9mm Mini Auto-Lock Knife. Heavy duty plastic body, positive lock system.

TASK



T130B 18mm Auto-Lock Knife. Heavy duty plastic body, positive lock system.

TASK



T98 Trapezoid Blade Knife. Wrap around safety tip ensures blade stays in place when under extreme pressure, metal handle, uses D blades below



K000535 2-IN-1 Interlock folding knife with 10 blades. Dual function utility knife and folding knife. Stainless steel construction.



K000495 Carpet / Linoleum knife. 8", professional, comfort grip, stainless steel blade



S001164 Wallboard Saw. 6", ergo comfort grip, cross ground teeth, tempered steel blade.

TASK



RS-300 (05692) Metal Retractable Scraper. Includes 6 razor blades, takes type E replacement blades below.

TASK



T208B Poly Retractable Scraper. Uses regular square razor blades, type E as seen below.



S001500 Scraper. Multipurpose with 10 blades. Comfort grip and easy change blades.



37500 4" Wide Scraper
37510 10pk repl. blades Scrapemaster pro scraper, flex steel blades contour to window etc...



2 Pack Special!



48-22-1901F 2/Pack Milwaukee FastBack Utility Knife. One handed opening, easy blade change, wire stripper, gut hook and easy pocket storage.



300681 Lock Installation Kit Carbon steel lock installation kit designed for wood door sizes 1-3/8" and 1-3/4". Back set sizes 2-3/8" and 2-3/4"

BLADES

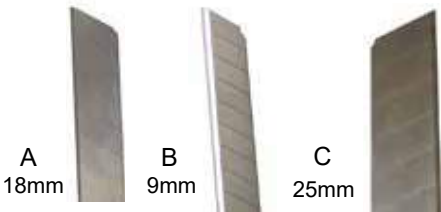

Knife Blades

Part#	Img.	Pkg.	Width	Description
48-22-1109	B	10	9mm	Milwaukee 2X life
T029R	B	10	9mm	Extra sharp double honed
T081R	A	10	18mm	Extra sharp double honed
T082R	A	50	18mm	Extra sharp double honed
T00739	C	5	25mm	PowerBlack 15% stronger

Razor/Scraper Blades

Part#	Img.	Pkg.	Description
T097R	D	5	Trapezoid high quality carbon steel
T00988	D	50	Trapezoid heavy duty high grade steel
48-22-1900	D	100	0.6mm Milwaukee trapezoid utility
T37467	E	5	.25mm single edge blade



MEGAPRO® Every bit better.



151 Standard
"15in1" - 7 Double end professional quality bits, this assortment provides the 14 most popular tips for driving screws. The shaft opening serves as a 1/4" hex driver!



151TP Tamperproof
For all commercial/industrial tradesmen. The Tamperproof assortment includes the most popular security bits, including Spanners, Hex Pins and Star Pins. The shaft opening serves as a 1/4" hex driver!



211R2 Ratcheting
Patented "Pull-out" bit cartridge provides time saving and space saving convenience. Contains Bit Load FD4-6, PD0-3, PD1-2, SD1-2, TD10-15 and TD20-25



151SL44 Shaft-Lock
Locking Shaft eliminates the hassle of bits falling out of the shaft. Contains bit load, F4D4-6, P4D0-3, P4D1-2, S4D0-3, S4D1-2, T4D10-15 and T4D20-25.



151HX Hex (Allen)
The Hex (Allen) driver features 8 popular standard hex drive tips and 6 popular metric hex drive tips. For working on technical equipment, bicycles, motorcycles, skis, musical instruments and ready to assemble furniture.



141HVAC HVAC
1/4" socket adapter, this driver is a must for the professional mechanic. The valve stem bit is also a standard bit-type in the HVAC industry. The shaft opening serves as a 1/4" hex driver

Stainless Steel Bits

- High strength & optimum hardness
- Designed for high torque
- Specialty high-quality alloy steel
- High precision and exact fit in screw
- Reduces slip and come-out
- Amre Logo Stamped



962-22-0701 PHILIPS #1 2-3/4"
962-22-0702 PHILIPS #2 2-3/4"
962-22-0703 PHILIPS #3 2-3/4"



969-22-0701R ROBERTSON #1 2-3/4"
969-22-0702R ROBERTSON #2 2-3/4"
969-22-0703R ROBERTSON #3 2-3/4"



969-22-1501R ROBERTSON #1 6"
969-22-1502R ROBERTSON #2 6"
969-22-1503R ROBERTSON #3 6"



962-22-1501 PHILIPS #1 6"
962-22-1502 PHILIPS #2 6"
962-22-1503 PHILIPS #3 6"



967-21-1-06014
Quick Bit Holder. 60mm Long



Milwaukee

48-22-2302
Milwaukee 10-in-1 Ratcheting Screwdriver. Includes 3-1/2" Phillips #1 and #2, Slotted 1/4" and 3/16" and square #1, #2 and #3



Milwaukee

48-22-2320
Milwaukee 8-in-1 Ratcheting Compact Screwdriver. Includes 1-1/2" Phillips #1 and #2, Slotted 1/16" and 3/32" and square #1, #2 and Torx 15



S003395
14-Piece Precision Screwdriver Set. Hardened & tempered chrome vanadium blades. Soft grip handles. Comes on a handy rack for storage. Sizes: slotted - 1.5, 2.0, 2.5, 3.0, 3.5; phillips - 2.0, 2.5, 3.0, 4.0; torx - T6, T8, T10, T15, T20

Don't lose loose screws again!



SM-70299
Magnetic Tray, 6". Great for holding screws, bolts and other small parts, while making repairs

Shopro Screwdrivers

- Rubber Handle
- Magnetic Tip



Slot Head (Flat Head)

S002200 1/8" x 3"
S002205 3/16" x 3"
S002210 1/4" x 6"
S002215 5/16" x 6"
S002220 3/8" x 8"

Phillips Head

S002230 #1 x 5"
S002235 #2 Stubby
S002240 #2 x 4"
S002245 #3 x 6"

Robertson Head (Square Head)

S002260 #S0 x 3"
S002265 #S1 x 5"
S002270 #S2 Stub.
S002275 #S2 x 5"
S002280 #S3 x 6"





- P009657** Bent Nose
- P009672** Long Nose
- P009687** Linesman
- P009682** Diagonal
- P009677** Needle Nose
- Mini Pliers**, Drop forged, chrome vanadium steel. Great for tight spots.
- P008040** Diagonal 6-1/2"
- P007990** Linesman 6"
- P009730** Slip Joint 6"
- P009290** Long Nose 6-1/2"
- Pliers**, Drop forged, solid joint construction, Comfort grip
- P008045** Diagonal 7-1/2"
- P007995** Linesman 8"
- P009735** Slip Joint 8"
- P009295** Long Nose 8"
- Pliers**, Drop forged, solid joint construction, Comfort grip

 <p>P010005C Snap Ring Pliers. 4 Head sizes included. Comfort grips. 3/8" to 2"</p>	 <p>P009603 6" Long Nose W011150 7" Wrench W011200 10" Wrench Locking pliers/wrenches. Quick size adjustment, 1 hand operation, Vise clamps. Drop forged jaws.</p>	 <p>P010252 10" P008660 12" Water Pump Pliers. Comfort grip, chrome vanadium steel</p>	 <p>KLEIN TOOLS D502-6 6" D502-10 10" D502-12 12" D502-16 16" Pump Pliers</p>
---	--	--	---

 <p>W006250 6" W006300 8" W006350 10" W006400 12" Adjustable wrench. Chrome vanadium steel</p>	 <p>W006175 Adjustable wrench Wide mouth 8", jaws open to 1-1/2", comfort grip.</p>	<p>24 HR.  Order by 4pm for 24-48hr shipping to almost anywhere in Canada!</p>	 <p>H005340 3pc Hex Key Set. Includes Metric, Torx and SAE sizes, anodized aluminum holder with chrome vanadium steel keys.</p>	 <p>B003451 18" B003501 24" Bolt Cutters. Heavy Duty. Rubber comfort grip with hardened tempered chrome vanadium steel construction.</p>
---	---	--	--	---

CRIMPER . CUTTERS				
 <p>T004600 Straight Cut T004612 Left Cut T004620 Right Cut Tin snips. Aviation, vinyl coated handles, carbon steel blades</p>	 <p>T004500 Straight Tin snips. Forged steel honed cutting edge, vinyl looped handles.</p>	 <p>1005 Crimping/Cutting Tools Non-Insulated/Insulated Terminals• Crimping die marked for insulated and non-insulated solderless terminals and connectors.</p>	 <p>1011K Multi-Purpose Wire Stripper/Cutter</p>	 <p>GS-366 Crimping Tool Cuts Wire Strips Wire -Cuts Bolts Crimps Terminals. Insulated/Non- Insulated, Cushioned Handles</p>





P007050 10"
P007100 14"
P007150 18"
P007200 24"
 Steel Pipe Wrench. Adjustable, drop forged hardened and tempered alloy steel, heat treated.



P007405 18"
P007455 24"
 Aluminum Pipe Wrench. Light weight, adjustable, drop forged hardened tempered aluminum alloy, heat treated



H001151
 Hammer, Stubby. 8oz, comfort grip, drop forged, great for compact spaces.



H001655
 Hammer, 16oz, hardwood handle, drop forged tempered steel



H001358
 Hammer, 16oz, fiberglass handle, drop forged steel head



M000700
 Rubber Mallet. 16oz. Metal handle with comfort rubber grip.



W005460
 Flat Bar. Multipurpose, heavy duty, drop forged, 15". pry, pull or scrape.



C003945 4pc
 Chisel set, 4pc, 1/4", 1/2", 3/4" and 1". High carbon steel, 7-1/4" length



T004906
 11-IN-1 Multi-Function Tool. Pliers, hammer, lg & sm slotted screwdrivers, phillips screwdriver, file, saw, lg & sm knife, nail puller, bottle opener



48-22-5506
 6ft/2m Keychain Tape Measure
 Nylon blade, 5 point reinforced frame for drop protection



48-22-5525 25'
 Milwaukee Tape Measure. 9ft standout, 10x durability, wide base, 1-1/16" wide, optimized hook



T001689AST-DB 1"x16' SAE & Metric
T001693AST-DB 1"x25' SAE*
T001691AST-DB 1"x25' SAE & Metric
T001370AST-DB 1"x25' Double Sided SAE & Metric
T001731AST-DB 1-1/4"x25' Extra Wide
 Tape Measures. SAE (Standard American Equivalent-Inches) Metric (Centimeters) Easy to read black and red markings, slide down locking bar, Yellow and Black rubberized case. * models include easy to read fractions.



03000015 2" X 12"
03000022 4" X 12"
03000032 6" X 12"
03000042 8" X 12"
03000052 12" X 12"
 Cardboard parts boxes. Per each.



T004854
 Tactix Organizer.
 - Clear top
 - Removable tabs
 - 22 compartment, 12"



T004837 26"
 Tactix 26" Full Handle Tool Box w/ 2 organizers.
 - Auto-lock interactive latch
 - Removable organizers and tray
 - 26" x 12" x 11-1/8".



T004834
 2-In-1 Rolling Tool Box Set
 - Lift-out organizer top with 11 compartments
 - Full length telescopic aluminum handle
 - Heavy duty steel latches
 - Lift-out carry trays



L003305
 Torpedo Level. 9" magnetic, aluminum, easy view top. Also includes 2 carpenter pencils and sharpener.



L003310 24"
L003322 36"
L003334 48"
 I Beam Level. 3 vials, aluminum construction with plastic end caps.























TLMIR3
 Telescopic Rectangular Mirror. 2-1/8" x 3-1/2", can extend to 15-1/4"



46-TLMIR1 1-1/4" Diameter
46-TLMIR2 2-1/4" Diameter
 Telescoping Inspection Mirror. Stainless steel w/brass backed mirrors.



 <p>4354 1/4"-2-1/2" Zip action tube cutter. Professional duty, 4 roller top support, fast ratchet action</p>	 <p>4351 Mini-Tube Cutter 1/8" - 7/8"</p>	 <p>4350 Deluxe Tube Cutter For 1/8" - 1 1/8"</p>	 <p>48-22-4260 1/2" 48-22-4261 3/4" Milwaukee 1/2" Close Quarters Tubing Cutters are optimized for tough cuts in tight spaces</p>	 <p>48-22-4263 Milwaukee® Close Quarters Tubing Cutters 1/2", 3/4", and 1" cutters and a storage case.</p>
 <p>ULN1110 Step seat wrench with long shaft for faucets and tub and shower seats</p>	 <p>ULN1124 Seat wrench 4 piece ratchet style</p>	 <p>104421 Moen cartridge puller</p>	 <p>7040 Stem & Cartridge Wrench removes Moen stems & cartridges from faucets and shower valves</p>	 <p>4659 BigYank handle puller. Removes small and large handles.</p>
 <p>4555 Tub Drain and Spud Wrench</p>	 <p>4554 Smart Dumbbell Tub Drain Wrench, Installs & Removes Tub Drains and closet spuds. Heavy Die Cast Aluminium locknuts.</p>	 <p>7000L NutCracker. Quickly removes corroded 1/2" zinc locknuts from faucet shanks. Threads on and easily cuts out of nut.</p>	 <p>ULN1112 11" ULN1112A 16" Spring loaded basin</p>	 <p>4573 Extends from 9" - 16". Swivel Jaw with spring. Fits up to 2" locknuts, also fits single lever faucet locknuts.</p>
 <p>1701 4 Way Sillcock Key</p>	 <p>Q1102LF Toilet plunger designed with a funnel nose for low flow toilets. Pressure Relief valve prevents water from overflowing</p>	 <p>Q1102LP Toilet Plunger 22.5" / 57 cm, Funnelled Nose More Plunge Per Push, Won't Skid, Fit all Toilet Bowls</p>	 <p>4642 Funnelled Nose, Dark Blue, 162 Cubic Inch Displacement.</p>	 <p>24 Applications! PPC-300 CAK-1 Optional adaptor kit Pressure. Can also be used in toilets, shower stalls, floor drains & garbage disposals</p>

THE TRUNK

PRO PICK

1-of-a-Kind Product

Save Time

- No Mess
- No Strain
- No Contamination

TRUNK-1
THE TRUNK is a new solution for plumbers designed by a plumber. When you pull a toilet, water always remains in the trap so now no more wet socks, no more mess, no back strain and no contamination and save time!

Simple: pull the handle to suck out the water then moving forward & pushing the water down the drain.





- Q1100A** 4" red rubber force cup with 9" handle, great for sinks
- Q1100** 5" red rubber force cup with handle
- Q1102A** Heavy duty force cup beehive shape black rubber with handle
- Q1101** Toilet plunger. 5 1/2 in. x 21 in. Black force cup w/wooden handle.
- Q1102** Extra large cup for best pressure with positive seal, 19" handle



48-22-0218 18"
Milwaukee® PVC Saw features a tool free blade change to avoid downtime and increase efficiency in the field. Complete with rubber over mold for comfort



48-22-0012
Milwaukee® Compact Hack Saw. Tool free blade change and comfort handle. Great for tight spaces. Uses regular hack saw blades.



4267
Professional Hacksaw 12" Frame



4254
Adjustable Hacksaw Frame 10-12"



4290
Tiny Tim Hacksaw
4292
Tiny Tim replacement blades, 10/pk



10/pk
48-43-0610 18TPI
48-43-0620 24TPI
48-43-0630 32TPI
Milwaukee 12" Hack Saw Blades. Super tough Bi-metal last 3X longer than conventional blades.



31315 2yds
3103 5yds
3102 10yds
ULN1038 25yds
Sand Cloth. 120 grit with aluminum oxide abrasive. Popular for plumbing fittings. 1-1/2" wide



568-001 1-1/2" X 5 yds.
3109 1-1/2" X 10 yds.
Premium 180 Grit Open Mesh Abrasive Cloth, Recommended for Extra Tough Jobs.

Solid Wire

Part#	Size	Type
20019	1lb	50/50, Wire Solder
50192	0.5lb	50/50, Wire Solder

Cor Solder

Part#	Size	Type
20116	1lb	50/50, Acid Core Solder
50194	0.5lb	60/40, Rosin Core Solder

Lead Free Solder

Part#	Size	Type
23001	1lb	Silver Solder
23000	0.5lb	Silver Solder



Oatey



5114 1/2"
5116 3/4"
5118 1"
Copper fitting brushes



5150
1/2" or 3/4" 4-N-1 Combination Brush, Cleans and Prepares Joints For Soldering. Removes Dirt and Debris. Just 2" or 3" of clearance is all you need.

24 HR.

Order by 4pm for 24-48hr shipping to almost anywhere in Canada!



SFG-1/2 236ml
SOS Paste solder flux, greenless, Lead-Free. Odorless, Self-Cleaning, All-Weather.



48420 1.7 oz.
Oatey #5 Flux cleans & fluxes at the same time. Effective on all metals except aluminium, magnesium and stainless steel. 100% lead free



45804 16oz. Spray
All purpose leak detector, detects leaks quickly on all types of tubing, valves, cylinders, pressure tanks or other systems under air, gas, or oxygen pressure. Slow evaporation rate



61-71036 6"x9"
61-71038 9"x12"
HeatShield. Protection for soldering jobs, can withstand heat up to 2000°F



MT-2 14.01 oz
Mapp Gas. Ideal for medium to heavy soldering and brazing. Flame temperature in air = 3600F.



PT-1 14.01 oz
Propane. Ideal for general soldering. Flame temperature in air = 3450F.



0386-0860
TurboTorch TP-10 Swirl Torch Map-Pro/LP gas. 360deg swivel tip, solid brass, includes pressure regulator. Use with standard MAP-pro and propane tanks



0386-1293
Turbotorch Extreme Torch Swirl, MAP-Pro/LP Gas. Faster brazing times and less gas consumption. Generates more heat than other hand torches. Convenient self-lighting triggers. Tanks sold separately.





R-15SM 1/4" x 15ft
R-25SM 1/4" x 25ft
 Spin through hand snake. Hollow cable with regular head. Easy grip handle for easy rotation.

Manual Feed



Part # Cables Included

- SV-F-WC** 25ft x 1/4"
 - SV-A-WC** 25ft x 1/4" & 25ftx3/8"
 - SV-B-WC** 25ft x 1/4" & 35ftx3/8"
 - SV-C-WC** 50ft x 1/4" & 35ftx3/8"
- Super-Vee Drain Cleaner. Complete system to clean lines up to 3" in diameter. Super easy to change cables with slide action chuck. Ball bearing double insulated reversible motor with variable speed control. Included carrying case, A, B & C models include HECS cutter set.



MRP-B 75ft x 3/8"
 Mini-Rooter "Pro" Drain Cleaner. A perfect combination of affordable cost, light-weight, durability and versatility. Cleans up to 4" drains. Extra features include Foot Pedal, built-in dolly with 6" semi-pneumatic wheels and folding handle for easy transport. 1/3HP motor with reverse switch, 10ft power cord, GFCI, Includes leather gloves and MRCS cutter set.



Attach to drill!

CP-25SM 25ft x 1/4"
 Power Spin-Thru Snake. Hollow cable with regular head, steel drum, T-grip handle. Includes spindle so it can be attached to an electric drill.



Power Feed



- PV-F-WC** 25 ft X 1/4" Down Head
 - PV-A-WC** 25 ft X 1/4" Down Head & 25ftx3/8"
 - PV-B-WC** 25 ft X 1/4" Down Head & 35ftx3/8"
 - PV-C-WC** 50 ft X 1/4" Down Head & 35ftx3/8"
- Power-Vee Drain Cleaner combines same specs as Super-Vee with the added benefit of a Power Cable Feed. Feeds 3/8" cable at 16ft per minute. Super easy to change cables with slide action chuck. Ball bearing double insulated reversible motor with variable speed control. Included carrying case, A, B & C models include HECS cutter set.



P-T3-D 100ft x 1/2"
 Sewerooter T-3, large capacity, and portability. 10" wheels, 1/3 hp motor with capacitor, a pneumatic foot pedal and reverse switch; plus a ground fault circuit interrupter.



down head



EL Head



male/female

Cable with Basic EL Plug Head

- 25HE1** 1/4" x 25ft
 - 50HE1** 1/4" x 50ft
- Cable with Down Head
- 25HE1-DH** 1/4" x 25ft
 - 50HE1-DH** 1/4" x 50ft
- Cable with Male & Female Connectors
- 25EM2** 3/8" x 25ft
 - 50EM2** 3/8" x 50ft
 - 75EM2** 3/8" x 75ft
 - 25EM3** 1/2" x 25ft
 - 50EM3** 1/2" x 50ft
 - 75EM3** 1/2" x 75ft

General Wire Flexicore Snake Cables. Heavy gauge 49 strand aircraft-type wire has unequalled strength and the right amount of flexibility. Also available in 5/8" and 3/4" as well as 100ft.



TU4

R3NKH 3ft Economy Economy Toilet Auger. 5/8"Dia galvanized steel tube with 3/8" cable, plastic bowl guard. Regular head.

3FL 3ft Professional Toilet Auger. 3/4"Dia brass steel tube with 1/2" double layer Flexicore cable. Protective vinyl guard. Regular head

T6FL 6ft Telescopic Professional Toilet Auger. 1-1/8"Dia brass steel tube with 1/2" double layer Flexicore cable. Protective vinyl guard. Extends from 3ft to 6ft. Regular head.

TU4 Urinal Auger, 1/4" Cable - 4' Long/Reg. Head, Urinal

- AH** Arrow Head Starting Bit*
 - BG** Boring Gimlet*
 - DHBG** Down Head Boring Gimlet
 - FAH** Flexible Arrow Head Cutter
 - 1-1/4SCB** 1-1/4" Side Cutter Blade 2pc
 - HECS** 5pc kit includes all above
 - 1-1/2UC** 1-1/2" U-Cutter*
 - 2SCB** 2" Side Cutter*
 - MRCS** 4pc kit incl. AH, BG, 1-1/2UC, 2SCB
 - 1CG** Clog Chopper
- General Wire Snake Heads and Cutters. All above models fits 3/8" cables except 2SCB. Models with * will fit 1/2" cables. See web for more info on other heads.



SOQ 1qt
SOG 1gal
 General Wire Snake Oil

Milwaukee Check online for this seasons models and new features!

NEW Features and improved heat distribution



M12 battery and charger included.



New Gray color!

M12 battery and charger included.

TOUGH SHELL
STRETCH POCKET VESTER
5X LONGER LIFE

Heated Mens Hoodies - 6HR. Run Time

SIZE	GRAY	RED	BLACK
SM	301G-21S	301R-21S	301B-21S
MED	301G-21M	301R-21M	301B-21M
L	301G-21L	301R-21L	301B-21L
XL	301G-21XL	301R-21XL	301B-21XL
XXL	301G-212X	301R-212X	301B-212X

Durable cotton blend, waffle-weave thermal liner, washer & dryer safe, back & chest heat zones, 3 heat settings. **Integrated battery pocket.** Fitted hood for full range of vision & fit under hard hat. Improved fit, less baggy, reinforced pocket edges.

Heated Mens Jackets - 8HR. Run Time

SIZE	GRAY	BLACK
SM	201G-21S	201B-21S
MED	201G-21M	201B-21M
L	201G-21L	201B-21L
XL	201G-21XL	201B-21XL
XXL	201G-212X	201B-212X

One-touch LED controller with (3) heat settings per heat zone. Water and wind resistant, built in USB charger. Washer/dryer safe. Improved fit, adjustable cuffs and waist. Drop tail extended back, longer sleeves. Integrated battery pocket. Freeflex™ mobility.



M12 battery and charger included.

8HR. Run Time



M12 battery and charger included.

6HR. Run Time

GRIDIRON
RIPSTOP POLYESTER
3x OUTLASTS
12oz COTTON SHIRT

Womens Heated Jacket

SIZE	BLACK
SM	231B-21S
MED	231B-21M
L	231B-21L
XL	231B-21XL

One-touch LED controller with (3) heat settings per heat zone. Water and wind resistant, built in USB charger. Washer/dryer safe. **Back, collar and front pocket heat zones.** Improved fit, tapered cut and thumb hole cuffs.

Heated Vests

SIZE	BLACK
L	271B-21L
XL	271B-21XL

3 Heat Settings, durable Ripstop shell and thermal fleece liner. Insulated, wind and water resistant, washer and dryer safe. **Redeveloped materials. Quieter, softer, improved mobility.** Rugged, reinforced utility pockets



Toques

GRAY
502G

Milwaukee fleece lined knit hat. One Size fits most. Thick knit beanie style hat fits best under a hard hat, for snug warmth on the job.



49-24-2301
Milwaukee 12V DC adapter for M12 heated jackets. **Allows for unlimited run time.**



48-11-2430
Milwaukee M12 Redlithium 3.0 battery pack



49-24-2310
Milwaukee M12 power source



48-59-1810
Milwaukee M18 / M12 vehicle charger



48-59-1201
M12™ Compact Charger and Power Source



48-59-1202
3ft Micro USB Cable and Wall Charger.



Outdoor Power Equipment



M18 Battery and Charger sold separate!

POWER TO CLEAR THICK BRUSH
FULL THROTTLE UNDER **1 SECOND**
UP TO **1 HOUR** PER BATTERY

0884-20 Bare Tool Only Milwaukee Cordless Compact Blower

Offers a best in class power to size ratio. Power control that includes a 3-speed electronic switch, lock-on and a variable speed trigger which allows for versatile clearing power. Moves air at 160 MPH and 100 CFM. Shock-absorbing polymer body and crush resistant nozzle.



New!



2725-21HD Kit w/Battery & Charger Milwaukee M18 Fuel Cordless String Trimmer. Has the power to clear thick brush, reaches full throttle in under 1 second, and provides up to 1 hour of run-time per charge. High and low speed settings with a variable speed trigger. 14"-16" cutting swath trims more grass in a single pass. 0.080" / 0.095" line diameter.
Includes (1) High Demand 9.0 Battery, Rapid Charger

49-16-2712 .80" x 150'

49-16-2713 .95" x 250'
Milwaukee Trimmer Line

Utilizing high grade polymers and a full mass, twisted design, provides longer life, greater cutting power, and longer run-time.

Milwaukee High Demand 9.0 Battery Pack
5X more run-time
35% more power
60% cooler than standard 18V batteries!

POWER TO CUT 3/4" BRANCHES
CUTS UP TO 30% FASTER
UP TO **2 HOURS** PER BATTERY



2726-20 Bare Tool Only
2726-21HD* Kit w/Battery & Charger Milwaukee M18 Fuel Cordless Hedge Trimmer. Has the power to cut 3/4" branches, cuts up to 30% faster, and provides up to 2 hours of run-time per charge. Slide-crank mechanism and all-metal gear case providing unmatched durability and longer life. 24" blade trims more material in a single pass.
***Includes** (1) High Demand 9.0 Battery, Rapid Charger

POWER TO CLEAR FROM 15 FT
UP TO **30% LESS NOISE**
LONGEST MAX CFM RUN-TIME



2728-20 Bare Tool Only
2728-21HD* Kit w/Battery & Charger Milwaukee M18 Fuel Cordless Blower. Has the power to clear from 15 ft, generates up to 30% less noise than gas, and provides the longest, max CFM run-time. Variable speed trigger for increased control. Moves air at 160 MPH & 100 CFM.
***Includes** (1) High Demand 9.0 Battery, Rapid Charger

Ask us about the Milwaukee "ONE KEY" Tools!

TOOL CONTROL **TOOL TRACKING** **INVENTORY MANAGEMENT** **TOOL REPORTING**





TRUST Amre Supply for competitive prices every day on Milwaukee Tools!



2503-22
M12 FUEL 1/2" Drill/Driver
 - Brushless motor 350lb torque
 - More Power 0-1700 RPM
 - Longer lasting battery
Includes (2) batteries 1 compact and 1 long life, charger, belt hook & case



2404-22
M12 FUEL 1/2" Hammer Drill/Driver
 - Brushless motor 350lb torque
 - More Power 0-1700 RPM
 - Longer lasting battery
Includes (2) batteries 1 compact and 1 long life, charger, belt hook & case



2453-22
M12 FUEL 1/4" Hex Impact Driver
 - Brushless motor 1200lb torque
 - 2 mode drive control precise/performance
 - More Power 0-2650 RPM
 - Longer lasting battery
Includes (1) battery, charger, belt hook & case



2401-22
M12 Cordless Screwdriver
 - Quick bit loading 1/4 Hex chuck
 - Battery fuel gauge
Includes (1) battery, charger



2497-22
M12™ Hammer Drill/Driver & Hex Impact Driver Kit
 - Battery fuel gauge, built-in LED light
 - Metal ratcheting chuck, ergo handles
Includes 2408-20 3/8" Hammer drill/driver, 2462-20 1/4" impact driver, (2) M12 batteries, charger and contractor bag.



0850-20 Bare Tool
M12 Compact Vacuum
 - Unmatched performance 33 CFM
 - Up to 29min of run time
 - c/w extension wand, crevice tool, utility nozzle
 - 1-1/4" common size
 - **Battery and charger sold separate**



2420-20 Bare Tool
2420-21 w/ 1 Battery & Charger
2420-22* w/2 Batteries & Charger
HACKZALL™ M12™ Cordless LITHIUM-ION Recip Saw - Keyless QUIK-LOK™, accepts both HACKZALL™ and SAWZALL® style blades, built-in LED Light, ***Includes** Battery, 30-Minute Charger, Carrying Case



2471-20 Bare Tools
2471-21* w/1 Battery & Charger
M12™ Cordless LITHIUM-ION Copper Tubing Cutter
 - Rotating cutting head for confined spaces
 - Automatic adjustment from 3/8" - 1" tubing
 - Water resistant, - Built-in LED light
*** Inc.** (1) Battery, 30-Min. Charger, Carrying Case



2415-21
M12™ Cordless Red LITHIUM-ION 3/8" Right Angle Drill Driver Kit
 - 3/8" Ratcheting Chuck
 - Built In LED's
Includes (1) Battery, 30-Minute Charger.

- **Lightweight**
- **Variable Speed**
- **No cords to deal with**
- **Handheld or flat base for floor use**

2571-21
M12 Drain Snake Kit
 Milwaukee M12 Drain Snake. Only 10 lbs, 0-500RPM variable speed, drum shield, flat base for hands-free operation, LED light for dark area like underneath sinks. Other cables sizes available, sold separate.
Includes 5/16" x 25' Bulbhead Cable, 20L Bucket, (1) Battery, Charger



2470-20 Bare Tool
2470-21* w/1 Battery & Charger
M12™ Cordless LITHIUM-ION PVC Shear Kit
 - Cuts up to 2" schedule 80 PVC in 3 seconds
 - Ultra Sharp Blade with Pierce Point
 - Stainless Steel Blade and Aluminium Jaw
 - Variable Speed Trigger
***Incl.** (1) Battery, 30-Minute Charger, Carrying Case

Service plumbers and facility maintenance crews ideal solution.



2576-20 Bare Tool Only
2576-21 w/1 Battery & Charger
Milwaukee M12 6' Trapsnake Toilet Auger.
 Professional Grade. Rubber boot to protect porcelain, fast work to clear clogged toilets, replaceable cables, 2" to 4" drains.
 Milwaukee M12 battery and charger sold separately on bare tool model.



- 48-11-2401** 1.5A/Hr Compact
 - 48-11-2420** 2.0A/Hr Compact
 - 48-11-2402** 3.0A/Hr XC
 - 48-11-2430** 3.0A/Hr Compact
 - 48-11-2440** 4.0A/Hr XC
 - 48-59-2401** AC M12 Wall Charger Only
 - 48-59-2420** M12 Charger w/2.0A Battery (48-59-1810 car charger also available)
- Milwaukee 30 Min. charger, charges all M12 batteries. Batteries include fuel gauge, XC battery is long life, sturdy base & high discharge



XC



Compact





2750-22CT
M18™ 1/4" Hex
Brushless Impact Driver Kit
 - 1,500lbs of torque and 0-2,800 RPM
 - Compact design
 - 50% longer run time and 2x life
Includes (2)M18™REDLITHIUM™ 2.0 Compact Batteries, M18™ & M12™ Multi-Voltage Charger & Carrying Case



2701-22CT
M18™ 1/2" Compact
Brushless Drill/Driver Kit.
 - 500lb torque
 - All metal gear case, compact design
 - 50% longer run time and 2x life
Includes (2) M18™REDLITHIUM™ 2.0 Compact Batteries, M18™ & M12™ Multi-Voltage Charger & Carrying Case



2702-22CT
M18™ 1/2" Compact
Brushless Hammer
Drill/Driver Kit.
 - 500lbs of torque and 0-450/0-1,800 RPM
 - All metal gear case, compact design
 - 50% longer run time and 2x life
Includes (2)M18™REDLITHIUM™ 2.0 Compact Batteries, M18™ & M12™ Multi-Voltage Charger & Carrying Case



2691-22
M18™ Cordless LITHIUM-ION
2-Tool Combo Kit
 - M18 1/2" chuck Compact Drill Driver and M18 1/4" Hex Impact Driver
 - Drill 1800RPM & 500lb torque, Impact 2750RPM & 1500lb torque
 - LED Light
Includes (2)M18™REDLITHIUM™ 2.0 Compact Batteries, M18™ & M12™ Multi-Voltage Charger & Carrying Case



2680-20
 Bare Tool (No Battery)
2680-22
 c/w 2 Batteries
M18™ Cordless Lithium-Ion Grinder
 - 4-pole motor delivers maximum power when cutting
 - Paddle switch for comfort and ease-of use
Includes (2) XC Extended Capacity Batteries, 1 hour charger, cut off wheel, Side Handle and contractor bag.



2697-22
M18™ Cordless LITHIUM-ION
2-Tool Combo Kit
2602-20 - 1/2" Hammer Drill Driver
2650-20 - 1/4" Hex Compact Impact Driver
Includes (2) XC Extended Capacity Batteries, 1-Hour Charger, Belt Hook, Contractor Bag



2645-20 Bare Tool (No Battery)
2645-22 c/w 2 Batteries
M18™ Cordless LITHIUM-ION Jig Saw Kit
 - QUIK-LOK™ Blade Clamp
 - Tool Free Shoe Bevel
 - 5-position orbital cutting
Includes (2) XC Extended Cap. Batteries, 1-Hr Charger, Jig Saw Blade, Non-Marring Shoe, Carrying Case



2621-20
 Bare Tool (No Battery)
2621-22
 c/w 2 Batteries
M18 Sawzall Cordless LITHIUM-ION
Reciprocating Saw
 - Quik-lok blade clamp
 - Gear protecting clutch, 30% faster w/less vibration
 - Variable speed trigger
Includes (2) XC Extended Capacity Batteries, Multi-Volt M12/M18 Charger, Blade, Carrying Case.



2630-20 Bare Tool (No Battery)
2630-22 c/w 2 Batteries
M18™ Cordless LITHIUM-ION 6 1/2"
Circular Saw
 - Ergonomic, compact and lightweight
 - Electronic brake stops
Includes (2) XC Extended Capacity Batteries, 1-Hour Charger, Circular Saw Blade, Contractor Bag



2772A-20 Bare Tool Only
2772A-21 Kit w/1 Battery, charger & storage bucket
Milwaukee M18 Drain Snake
 Variable speed cable spin 0-550RPM, variable speed feed 0-8"/sec, maintains speed during feed/retract, brushless technology, 2X more powerful than corded, c/w 5/16"x35' bulb head cable w/rust guard.



2735-20
M18 LED Worklight
 - 135° rotating head
 - Sealed aluminum for impact and weather durability
 - Integrated hook for easy use



TRUST Amre Supply for competitive prices every day on Milwaukee Tools!



Choose higher amp/hr
for longer run time!

Part #	Amp/Hr
48-11-1815	1.5A
48-11-1820	2.0A
48-11-1828	3.0A
48-11-1840	4.0A
48-11-1890	9.0A



48-11-1815 / 20

48-11-1840 / 28

48-11-1890

Milwaukee M18 Lithium-Ion Batteries

Delivers 2X more run time and 20% more power than standard lithium ion batteries. On board fuel gauge, REDLINK overload protection, all weather performance.

0886-20 Bare Tool M18™ Jobsite Fan

- Best-in-class power, 284CFM, 18MPH
- Upto 17hrs run time with XC5.0 battery
- 120deg adj, 3speed, 4 hangers, 9 stop positions
- Battery and charger sold separate



48-59-1812 Standard Charge 48-59-1808 Rapid Charger* M18 & M12 Multi-Voltage Charger

- Charges both M12 and M18 batteries
- Sequential charging, Redlink intelligent charging
- AC 120V
- *Rapid charger charges batteries up to 40% faster



48-59-1810 M18 and M12 Vehicle Charger

- Charges both M12 and M18 batteries
- 12V or 24V DC outlet
- Auto shut-down to prevent overcharging

2792-20 M18™ Jobsite Radio/Charger

- Bluetooth over 100ft away
- USB power port, FM/AM, Aux
- 40watt Premium speakers
- Quickly charges M18 batteries
- Includes** (2) AAA batteries, 16" Aux Cord



2361-20 M18™ LED Flood Light

- Up to 30% brighter than corded 250w halogen
- EMT Hanger, Key Hole Hanger, Cross Bar Hanger, Handle Hanger
- 1,300 lumens
- Works on M18 batteries sold separate



0880-20 M18™ Cordless LITHIUM-ION Wet/Dry Vacuum

- Works on all Milwaukee 18V slide-on batteries,
- Powerful motor
- Tool box style
- Reusable wet/dry filter
- Includes** Filter Assembly, Crevice Tool, Wide Utility Nozzle, Hose.
- Batteries and Charger Sold Separately*



2890-20 M18™ Jobsite Radio

- High Performance Audio System with deep bass
- Durable, portable, metal grills, digital AM/FM tuner,
- 2.1A USB Charger, Aux In cable included, Powered by all M18™ Batteries or A/C outlet (battery not included) Up to 12hrs run time with M18™ 5.0Ah battery

Corded Tools



8975-6 Dual Temperature Heat Gun

- Dual temperature 570 and 1000° F, 11.6 amp motor
- Unique impact resistant heating element
- Off, high and low



6509-31 3/4" Stroke Length (w/case) Sawzall® Recip Saw Kit

- Powerful 12 Amp Motor
- Gear Protecting Clutch
- Counter Weighted Mechanism
- QUIK-LOK™ Blade Clamp
- Includes** Sawzall® Recip Saw

**Milwaukee
Tools!** Check
website for current
pricing and sales
flyers

www.amresupply.com/tools



6130-33 4-1/2" Angle Grinder

- 7.0 amp, 750MWO motor delivers power
- 12,000RPM for quick material removal
- Slim ergonomic design w/lock button
- Airflow overdrive w/improved cooling

6390-20 TILT-LOK™ 7-1/4" Circular Saw

- Main handle adjusts
- 7-1/4 inch saw
- 15 amp, 3.25 peak horsepower motor
- Wide, clear sight line
- Includes** Circular Saw Blade, Hex Blade Wrench



TRUST Amre Supply for competitive prices every day on Milwaukee Tools!



Rotating Head & Larger Screen

2313-21 3ft cable

2314-21 9ft cable w/plumbing ball attach.

M-SPECTOR 360™ Inspection Camera Kit

- Rotating larger 2.7" High-Res Color Screen
- 4 LED lights reduces shadow, 9mm sensor
- Enhanced cable & aluminum head

Includes 1 M12 battery, charger, hook, magnet, mirror, and carrying case



2267-20

10:1 Infrared Temp-Gun™

- Measures surface temps -22F to 752F
- 10:1 distance ratio, premium LCD display
- Multi-modes, easy setup
- 9V battery and manual included



2309-20
9V Milwaukee M-Spector Inspection Scope.

2.7" LCD display, 9mm digital inspection scope, 4 surround LED lights, includes pipe guide attachment, 9V battery and case



2206-20
HVAC Fork Meter

Five tools in one providing current measurement, temperature measurement, voltage measurement, voltage detection and task lighting. 200amp current range. Voltage range 1000V AC/DC, temp range -40°F to 752°F, fork opening 0.63". Incl. (2) AA batteries, test lead set, dial banana thermocouple, manual



2281-20
Laser Distance Meter

- Measures up to 200' within 1/16"
- Easy read display w/backlight
- 5 different measurement functions including area & volume
- Memory storage of last 10 readings
Includes (2) AAA batteries, case and manual



2210-20
Fluorescent Lighting Tester

Test lamps, ballast and pins. Complete 3in1 solution 2.5' fully retractable antenna. Visual and audible tool feedback, built in LED flashlight. Compatible lamps T5, T8 and T12. Carry Case, manual and 4AA Batteries incl.



2235-20
400 Amp Clamp Meter

- Measures up to 400 amps AC, Large 1.0" jaw opening
- Wide Voltage range - 600 AC/DC volts
- Built-In LED Work Light
Incl: One (1) electrical test, lead set, red and black, Two (2) AAA batteries, Manual



2216-20
Digital Multimeter

- Wide Voltage range - 600 AC /DC volts
- Resistance range from 600 ohm to 40 Mohm, Auto Range to mV
- Frequency measurements from 10Hz to 50kHz
- Current Measurement to 10AAC/DC, Capacitance to 1000 µF
Incl: (1) electrical test lead set, (2) AA batteries, Manual



GFI-3501

Tests ground fault receptacles by overloading circuit and tripping GFCI. Easy to use. Simply plug tester into any circuit protected by a ground fault receptacle (110 - 125 V AC) and press black button to overload circuit.



GRT-3500

Receptacle Tester. Makes quick work out of any electrical project. Compact ergonomic design. Neon lamps indicate 6 common wiring conditions. 3-prong outlets

New!



2291-20
Sub-Scanner M12 Stud Finder

Detect rebar up to 6" deep in concrete, as well as the location of wood and metal studs beneath drywall. Requires M12 battery. **Battery sold separate**



M002005

DC & AC Voltage, DC Amperage, voltage drop. Diode, transistor hFE, temperature and room temperature measurements

Before you can fix it, You'll need to Find it.

Powerful Thermal Imaging Camera



LW-EAA 1000 ft



UW-BAA 1000 ft

LT-BAA 1800 ft

UT-BAA 1800 ft

Adapters

- LW-AD1** Dock extender, Iphone, Otterbox
- UW-AD1** Micro USB, Female, Male, Android, Otterbox
- UW-AD2** USB 2.0, 5 pin male, 5pin female, Nexus 5.



2202-20
Voltage Detector with LED

- Extra bright LED
- CAT IV 1000V safety rating
- Power On indicator light
- Pocket clip
- Visual & Audible Indication
Includes (2) AAA Batteries, Instructions



GVD-3504

Indicates the presence of AC Voltage from 50 - 600 V. Visual (flashing) and audible (beeping) indicators signal presence of voltage. Built-in "safe test" feature assures batteries are operating properly.



48-32-1500 38pc

QUIK-LOK Drill And Drive Set

- * Universal QUIK-LOK™
- * Premium Grade S2 Tool Steel Screwdriver Bits durable composition for longer bit life
- * Titanium Hex Shank Drill Bits - long life and superior performance
- * Magnetic Nut Drivers - ideal for fast, easy driving of nuts, bolts and hex head screws



48-32-4006 40pc

SHOCKWAVE™ Drilling & Driving Bit Set

Great assortment of Milwaukee drill bits, drive bits and screwdriver bits. See website for full details.



48-89-2803 15pc

Thunderbolt® Black Oxide Jobber length drill bits

- * (1) 1/16"
- * (1) 5/64"
- * (1) 3/32"
- * (1) 7/64"
- * (1) 1/8"
- * (1) 9/64"
- * (1) 5/32"
- * (1) 11/64"
- * (1) 3/16"
- * (1) 13/64"
- * (1) 7/32"
- * (1) 1/4"
- * (1) 9/32"
- * (1) 5/16"
- * (1) 3/8"



48-89-2802 29pc

Thunderbolt® Black Oxide Drill Bit Set

- 1/16" through 1/2" by 64ths
- *Parabolic Flute, Clears Chips Faster
- *135° degree Split Point, Precision Start
- No Walking
- *3-Flat Secure Grip Shank, Reduces Bit Slipping in Chuck



48-89-0011 14pc

Milwaukee Thunderbolt Titanium Coated Drill Bit Set

- Reduced heat for up to 3X longer life
- 1/16", 5/64", 3/32", 7/64", (2) 1/8", 9/64", 5/32", 3/16", 7/32", 1/4", 5/16", 3/8" and 1/2".



49-22-0175 8pc

Universal QUIK-LOK™ Flat Boring Set

- * Flat Boring Set provides quick and easy accessory changes
- * Double Wing Spurs
- * Patented Cutting Edge, easy wood boring
- * 1/4 in. Quick-Change Hex Shank for use in all Universal QUIK-LOK™ Extensions



48-20-8851 5pc

Milwaukee Hammer-Drill Bit Set

- 3-Flat secure-grip shank
- Faster drilling, longer life carbide tips
- * (1) 1/4" x 6"
- * (1) 3/8" x 6"
- * (1) 5/32" x 6"
- * (1) 3/16" x 6"
- * (1) 5/16" x 6"



- 48-89-2710** 1/16"
- 48-89-2711** 5/64"
- 48-89-2712** 3/32"
- 48-89-2713** 7/64"
- 48-89-2714** 1/8"
- 48-89-2715** 9/64"
- 48-89-2716** 5/32"
- 48-89-2717** 11/64"
- 48-89-2718** 3/16"
- 48-89-2720** 7/32"
- 48-89-2721** 15/64"
- 48-89-2722** 1/4"

- 48-89-2723** 17/64"
- 48-89-2725** 19/64"
- 48-89-2726** 5/16"
- 48-89-2728** 11/32"
- 48-89-2730** 3/8"
- 48-89-2734** 7/16"
- 48-89-2736** 15/32"
- 48-89-2738** 1/2"

Milwaukee® Thunderbolt® Black Oxide jobber length drill bits are designed for extreme durability and long life. Corrosion resistant, use on metal, wood, and plastic.

48-13-0400 4pc

Speed Feed™ Self-Feeding Wood Bits are made for drilling fast holes in clean wood up to 10 times faster. Includes 1/2", 5/8", 3/4" and 1"



CIRCULAR SAW BLADES

- 48-40-4108** 6-1/2 in. diameter
- 48-40-4120** 7-1/4 in. diameter
- * 24 carbide teeth
- * 5/8 in. arbor
- * Thin kerf for faster cutting
- * Framing and ripping blade



- 48-43-0610** 18TPI
- 48-43-0620** 24TPI
- 48-43-0630** 32TPI

Milwaukee 12" Hack Saw Blades. Super tough Bi-metal last 3X longer than conventional blades. 10/pkg



49-22-1178 5pc

Bi-Metal Jig Saw blades

- * 9/32 in. Width, T-Shank
- * Metal Cutting Blades: 48-42-5121, 48-42-5161, 48-42-5190
- * General Purpose Blades: 48-42-5300, 48-42-5310



49-22-1131 14pc

Ice Hardened™ Metal Cutting Sawzall® Blade Set

- * Four (4) 6" 14 TPI blades
- * Four (4), 6" 18 TPI blades
- * Two (2) 9" 10 TPI The Torch® blades
- * Two (2) 9" 14 TPI The Torch® blades
- * Two (2) 9" 18 TPI The Torch® blades
- * One (1) Storage Pouch

Scraping has never been so easy!



- 49-00-5463** 1-1/2"
- 49-00-5456** 3"
- 49-00-5455** 5"
- 49-00-5450** Grout removal tool
- 49-22-5403** 3pc set 1-1/2", 3" and grout

Milwaukee Scraper Blades

Designed for effortless and efficient surface prep and material removal applications with all Hackzall™ and Sawzall® Recip Saws



SAWZALLS

DIAMOND

Part#	Blade	Qty.
48-00-1440	6"	1
48-00-1450	9"	1

TUNGSTEN CARBIDE

48-00-1420	6"	3
48-00-1430	9"	3

SUPER

48-00-5015	6" - 6 TPI	5
48-00-5016	9" - 6 TPI	5
48-00-5035	6" - 5 TPI, 5/8T	5
48-00-5036	9" - 5 TPI, 5/8T	5
48-00-5037	12" - 5 TPI, 5/8T	5
48-00-5091	6" - 8/12 TPI	5
48-00-5093	8" - 8/12 TPI	5
48-00-5094	12" - 8/12 TPI	5
48-00-5182	6" - 14 TPI	5
48-00-5184	6" - 18 TPI	5
48-00-5186	6" - 24 TPI	5
48-00-5187	9" - 14 TPI	5
48-00-5188	9" - 18 TPI	5
48-00-5189	12" - 18 TPI	5

THE WRECKER

48-00-5701	6" - 7/11 TPI	5
------------	---------------	---

THE AX

48-00-5021	6" - 5 TPI, 5/8T	5
48-00-5026	9" - 5 TPI, 5/8T	5
48-00-5027	12" - 5 TPI, 5/8T	5



DIAMOND/CARBIDE



THE AX



SUPER



THE WRECKER



THE TORCH



ICE HARDENED

THE TORCH

48-00-5712	6" - 10 TPI	5
48-00-5713	9" - 10 TPI	5
48-00-5782	6" - 14 TPI	5
48-00-5784	6" - 18 TPI	5
48-00-5787	9" - 14 TPI	5
48-00-5788	9" - 18 TPI	5
48-00-5789	12" - 18 TPI	5

ICE HARDENED

48-00-4091	6" - 8/12 TPI	5
48-00-4093	8" - 8/12 TPI	5
48-00-4182	6" - 14 TPI	5
48-00-4184	6" - 18 TPI	5
48-00-4188	9" - 18 TPI	5

ICE HARDENED - TORCH

48-00-4712	6" - 10 TPI	5
48-00-4782	6" - 14 TPI	5
48-00-4784	6" - 18 TPI	5
48-00-4787	9" - 14 TPI	5
48-00-4788	9" - 18 TPI	5

49-22-0220 10pc M12 HACKZALL™ Reciprocating Saw blades

- * Includes: 2 wood blades
- * 3 EMT blades
- * 2 duct blades
- * 3 PVC blades
- * Storage pouch



49-22-1129 12pc Sawzall® Blade Set

- * (4) 6" 18 TPI The Torch® blades
- * (2), 6" 8 TPI The Wrecker™ blades
- * (2) 6" 5/8 TPI The Ax™ blades
- * (2) 9" 5/8 TPI The Ax™ blades
- * (2) 9" 14 TPI The Torch® blades
- * (1) Storage Container

Hole Dozer Hole Saws

- * Rip Guard the strongest tooth form in the industry, backed by Limited Lifetime Tooth Break Warranty.
- * Bi-metal construction with 8% cobalt for increased wear resistance
- * Plug Jack an all access slot design that allows for full access during plug removal

Size	Metric	Part
3/4"	19 mm	49-56-0023
7/8"	22 mm	49-56-0032
1"	25 mm	49-56-0043
1-1/8"	29 mm	49-56-0052
1-1/4"	32 mm	49-56-0062
1-3/8"	35 mm	49-56-0072
1-1/2"	38 mm	49-56-0082
1-3/4"	44 mm	49-56-0102
2"	51 mm	49-56-0117
2-1/8"	54 mm	49-56-0127
2-1/4"	57 mm	49-56-0132
2-1/2"	64 mm	49-56-0147
2-5/8"	67 mm	49-56-0158
3"	76 mm	49-56-0173
3-1/2"	89 mm	49-56-0193
3-5/8"	92 mm	49-56-0197
4"	102 mm	49-56-0213
4-1/8"	105 mm	49-56-0217
4-1/2"	114 mm	49-56-0233



49-22-4175 15pc GENERAL PURPOSE Hole Dozer Hole Saw Kit

- * (11) Hole Saws: 3/4", 7/8", 1", 1-1/8", 1-3/8", 1-1/2", 1-3/4", 2", 2-1/8", 2-1/4", 2-1/2"
- * (2) Arbors with Pilot Bits: 49-56-7010, 49-56-9100
- * (2) Additional Pilot Bits: 49-56-8010
- * (1) Adapter: 49-56-6560
- * (1) Spacer: 49-67-0120



49-56-9075 7pc BIG HAWG Hole Cutter Set

- * (3) hole cutters: 2-1/8", 2-9/16", 3-5/8"
- * (1) arbor with pilot bit
- * (2) pilot bits
- * (1) diamond file
- * (1) hex wrench and impact resistant case



- 49-56-9000 2-1/8"
- 49-56-9005 2-1/4"
- 49-56-9010 2-9/16"
- 49-56-9020 3"
- 49-56-9030 3-5/8"
- 49-56-9045 4-1/4"
- 49-56-9050 4-5/8"
- 49-56-9065 6-1/4"



48-09-5055 Sharpening Diamond File

BIG HAWG Hole Cutter

- * Aggressive tooth geometry for up to 10X faster cutting than hole saws.
- * Deep gullets for easy plug removal.
- * 3 hardened steel teeth provide max durability against unintended nail impacts.
- * Cuts up to 600 holes in wood without needing to be re-sharpened.

Visit www.AMRESupply.com for our complete selection of individual drill bits!



Tools





48-32-4503

Shockwave magnetic 3/8" bit holder



Shockwave magnetic nutdrivers

- 49-66-4502 1/4" x 1-7/8" 1/pkg
- 49-66-4522 1/4" x 1-7/8" 3/pkg
- 49-66-4503 5/16" x 1-7/8" 1/pkg
- 49-66-4523 5/16" x 1-7/8" 3/pkg
- 49-66-4505 3/8" x 1-7/8" 1/pkg
- 49-66-4525 3/8" x 1-7/8" 3/pkg
- 49-66-4506 7/16" x 1-7/8" 1/pkg
- 49-66-4526 7/16" x 1-7/8" 3/pkg
- 49-66-4532 1/4" x 2-9/16" 1/pkg
- 49-66-4533 5/16" x 2-9/16" 1/pkg
- 49-66-4535 3/8" x 2-9/16" 1/pkg
- 49-66-4536 7/16" x 2-9/16" 1/pkg



49-66-4561 3pc

Shockwave magnetic nutdriver set

Diameter: 1/4 in, 5/16 in, 3/8 in
Length: 1-7/8 in



49-66-4562 4pc

Shockwave magnetic nutdriver set

Diameter: 1/4 in, 5/16 in, 3/8 in, 7/16 in
Length: 1-7/8 in



Hex Adapter - Square 1/4"

- 48-03-4405 3/8"
- 48-03-4410 1/2"

Shockwave phillips bit 1/4" x 1"

- 48-32-4411 #1 2/pkg
- 48-32-4412 #2 2/pkg
- 48-32-4601 #2 5/pkg
- 48-32-4413 #3 2/pkg



Shockwave Phillips bits 1/4"

- 48-32-4444 #2 1" 2/pkg
- 48-32-4462 #2 2" 1/pkg
- 48-32-4602 #2 2" 5/pkg
- 48-32-4463 #3 2" 1/pkg
- 48-32-4562 #2 3.5" 1/pkg



Square Recess bits 1/4" x 1"

- 48-32-4421 #1 2/pkg
- 48-32-4422 #2 2/pkg
- 48-32-4605 #2 5/pkg
- 48-32-4423 #3 2/pkg



Square Recess Power bits 1/4"

- 48-32-4471 #1 2" 1/pkg
- 48-32-4472 #2 2" 1/pkg
- 48-32-4606 #2 2" 5/pkg
- 48-32-4473 #3 2" 1/pkg
- 48-32-4572 #2 3.5" 1/pkg



Torx 2" Power bits 1/4" x 2"

- 48-32-4483 T15 1/pkg
- 48-32-4484 T20 1/pkg
- 48-32-4485 T25 1/pkg
- 48-32-4487 T30 1/pkg

Deep Well Socket 3/8" Impact Duty (1/pkg)

- 49-66-4422 5/16"
- 49-66-4424 3/8"
- 49-66-4425 7/16"



Deep Well Socket 3/8" (1/pkg)

- 49-66-4426 1/2"
- 49-66-4427 9/16"
- 49-66-4428 5/8"
- 49-66-4429 11/16"
- 49-66-4430 3/4"
- 49-66-4431 13/16"
- 49-66-4432 7/8"



Hex Shank Socket Adapter 1/4" (1/pkg)

- 48-32-5030 1/4"
- 48-32-5031 3/8"
- 48-32-5032 1/2"



49-66-4419 8pc

Deep Well Socket Set

* (1) 5/16", 3/8", 7/16", 1/2", 9/16", 5/8", 11/16", 3/4"
* Socket rail, 3/8" socket

48-32-4004 32pc

Shockwave™ Driver Bit Set

- (1) SHOCKWAVE™ Magnetic Bit Holder
- (1) 5/16", (1) 1/4" Magnetic Nut Driver
- (1) Phillips Bit 1" P1, (4) P2, (1) PR2 & (1) P3, (2) 2" P2
- (1) Square Bit 1" SQ1, (3) SQ2, (1) SQ3, (1) 2" SQ2
- (1) TORX® Bit 1" T15, (2) T20, (2) T25, (1) T30
- (1) TORX® Bit 2" T20, (1) T25
- (1) Slotted 1" #8, (10) #10, (1) 2" #10





- 48-13-0048** 6" X 1/2"
- 48-13-0058** 6" X 5/8"
- 48-13-0068** 6" X 3/4"
- 48-13-0078** 6" X 7/8"
- 48-13-0088** 6" X 1"
- 48-13-0108** 6" X 1-1/4"

Speedfeed Wood Bit

- * Up to 10 Times Faster Drilling vs. Flat Boring Bits
- * Coated Flutes for Fast Chip Removal
- * Double Wing Spurs for Clean Hole Cutting
- * 1/4" Power Groove Shank Fits All 1/4" Extensions



48-13-0400 4pc
SPEEDFEED Wood Bit Set

- * Made for drilling fast holes in clean wood.
- * 6" long, 1/4" hex.
- * Includes 1/2", 5/8", 3/4", and 1"



49-56-9105
BIG HAWG Hole Cutter Arbor 7/16"

- * Includes flat boring pilot bit
- * 7/16" quick change shank
- * Standard 5/8"-18 thread fits all hole saws or hole cutters 1-1/4" through 6-1/4"

49-56-7010
Hole Saw Arbor 3/8"

- * Durable hardened steel construction
- * Fits all hole saws up to 1-3/16 in.
- * Fits all drill chucks 3/8 in. and larger



49-56-8010
Arbor Pilot Bit

- * Thunderbolt® tapered web for added durability
- * 135° split point provides accurate hole placement
- * 3-flat shank won't slip in arbor or chuck
- * Parabolic flute clears chips faster



49-56-7250
Large Hole Saw Arbor 3/8" Ergo

- * Tool-free operation
- * Universal, quick change with all brands of hole saws
- * No adapters required
- * Durable hardened steel construction
- * Fits all hole saws 1-1/4 in. and larger
- * Fits all drill chucks 3/8 in. and larger



- 48-25-5140** 2-1/8"
 - 48-25-5150** 2-9/16"
 - 48-25-5240** 2-1/8" Repl. Blades(3)
 - 48-25-5250** 2-9/16" Repl. Blades (3)
- Switchblade Selffeed Bit**
(2) Replacement blades, (2) Feed Screws, (2) Set Screws and (1) Hex Wrench



49-56-7210
Twist Release Small Hole Saw Arbor

- * Universal, quick change w/all brands of hole saws
- * No adapters required
- * Fits all hole saws up to 1-3/16 in. & fits all drill chucks 3/8 in. and larger



49-17-0180
Bucket-Less Tool Organizer

- 50 total pockets of assorted shapes and sizes, heavy-duty water resistant polyester and padded handles



48-55-3510
Contractor Bag

- Soft Side Contractor Bag, water resistant, shoulder strap. Durable zipper closure. 18"L x 11"W x 10"H



48-22-1010
Staple/nail Gun

- Up to 75% More Driving Power
- Hi/Low power switch for driving control
- Tilt & Fire Mechanism-Fully drive staples at an angle
- Integrated Stapler Puller & All Metal Jam Free Magazine
- Stapler Flush Drive Surface & Belt Clip
- Compatible with Arrow t50® staples sizes - 9/16", 1/2", 3/8", 5/16", 1/4". Compatible with 5/8" & 1/2" 18ga brad nails



- 48-22-5525** 1-1/16" x 25"
- Milwaukee Tape Measure**
* Nylon blade protection 10x more resistant
* 9ft Standout and wide sturdy base
* Optimized hook and wire form belt clip



- 48-22-5506**
- 6ft/2m Keychain Tape Measure**
* Nylon blade
* 5 point reinforced frame for drop protection



New!



- 48-22-5230**
- Open Reel Long Tape**
300ft long. Won't kink or tear. 3/8" nylon bond steel blade. Metal reinforced handle

- 48-22-2302**
- Milwaukee 10-in-1 Ratcheting Screwdriver. Includes 3-1/2" Phillips #1 and #2, Slotted 1/4" and 3/16" and square #1, #2 and #3



- 48-22-2320**
- Milwaukee 8-in-1 Ratcheting Compact Screwdriver. Includes 1-1/2" Phillips #1 and #2, Slotted 1/16" and 3/32" and square #1, #2 and Torx 15



QUICK INDEX

3M Pads	57
ABS Cement	320
ABS Fittings	167, 168
ABS Pipe	168
Access Doors	175
Accordion Doors	287
Acrylic Handle	192, 202
Actuator	254, 256, 257
Adapter Valve	255, 258
Adhesive	320-322
Adjustable Closet Rods	301
Adjustable Shower Rods	316
Adjustable Wrench	343
Aerator	189, 205
Affresh	32, 34, 35, 234, 235
Air Conditioning	
Leak Sealant	276
Motor	245
Refrigerant	276
Units	275
Air Freshener	50-52
AirKing	
Fan Part	242, 244
Air Mover	80
Air Purifier	68
Air Separator	259
Air Switch	250
Air Vent	258
Air Vents	259
Air Vents & Scoops	258
Alarm Pump (Water)	221
Alarm Smoke	143, 144
American Sensor Smoke Alarm	143
American Std. Faucet	177-179, 189
American Std. Flushometer	209
American Std. Flushometer Part	209
American Std. Sink	158, 159
American Std. Toilet	147, 148
American Std. Toilet Part	151, 152, 154, 156
American Std. Urinal	147
Amperage Meter	353
Anti Fatigue Mat	79
Anti Skid Tape	331
Ant Powder / Spray	285
Apartment Appliance	225-227
Appliance	225-227
Appliance Cleaner	32-35, 234, 235
Appliance Parts	
Commercial Dryer	224
Commercial Washer	224
Dishwasher	235
Disposal	224
Dryer	Website
Range	229-232
Rangehood	233
Washer	Website
Aqua-dynamic Faucet	177-180
Part	189
Aqua-stats	251, 264
Armstrong Ceiling Tiles	310
Armstrong Pumps & Parts	261
Ashtrays	13
Auto Scrubber	82, 83
Auto-Vent	258
Awning Window Hardware	309
Axes	Website
Baby Diaper Disposal	67
Baby Diaper Stations	67
Backer Rod	295
Backflow Preventer	263
Back Pack Vacuum	76
Bags	12, 67, 77, 332
Bake & Broil Element	231, 232

Ballast	
Electronic	114-117
Fluorescent	114, 116, 117
HID	117
Magnetic	113, 117
Sign	117
Ball Valve	174-176
Bar Faucet	178
Baseboard Heater	245
Baseboard Heater Cover	272
Baseboard Register	270
Baseboard Thermostat	245, 266
Basin Wrench	345
Bathroom	
Accessories	315-317
Blower Wheel	244
Cabinet	314
Cleaning	25, 37, 45-48
Exhaust Fan	241-243
Exhaust Motor	241-243
Fan Blade	244
Fan Grill	244
Fan Motor	241-243
Faucet	179-187
Grab Bar	317
Hardware	315-317
Mirror	314
Partition Hardware	318, 319
Sink	158, 159
Sink Drain	160, 161
Sink Repair	160-162
Bath Tub	163
Bath Tub Door	163
Bathtub Surround	163
Batteries	142, 209, 350, 352
Battery Charger	352
Bearings	249, 260, 261
Bedbug Monitor	285
Bedbug Powder	285
Bed Bug Spray	284, 285
BedBug Trap	285
Belanger Faucet	177, 180
Belanger Repair Part	190
Belimo Actuator	256
Belimo Zone Valves	256
Bell & Gossett Air Vent	258
Bell & Gossett Circulator Pump	260
Bell & Gossett Expansion Tank	259
Bell & Gossett Pump Parts	260
Bells, Door	146
Belt	267
Belt Dressing	267, 325
Bench	332
Bi-Fold Door	287
Bi-Fold Door Hardware	302, 303
Bike Rack	332
Bike Stand	332
Bird Reflector	Website
Bird Spikes	Website
Blade, Fan	244
Blades, Hack Saw	346
Blades, Knife	341
Blades, Reciprocating	355
Blades, Saw	354, 355
Blower Assembly	245, 246
Blower, Bearing	249
Blower, Motor	241-246
Blower, Shafts	249
Body Harness	281
Boiler Chemical	263
Boiler Feed Water Valve	262, 263
Boiler Filter	263
Bolt Cutters	343
Bottle Bar	228
Bottle Filler	207
Bottle Filler Part	208
Box	
Electrical	133, 134
Tool	344
Bracket	
Bathroom Shower	166
Closet	302, 303
Curtain Rod	316

Handrail	310
I-Beam	311
L	330
Partition	319
Screen	306, 307
Shower Rod	316
Towel Bar	315
Wall	301
Bradley Repair Part	190
Brass Fitting	170, 171, 173
Brasso	35
Brillo Pad	57
BRK Smoke Alarm	143, 144
Broan Fan	233, 240, 241
Broan Fan Part	233, 241, 242, 244
Broan Range Hood	233
Broom	
Angle	59
Corn	59
Push	59
Broom Handle	61
Brush	
Counter	56
Deck	56
Scrub	56
Toilet	56
Bubbler	207
Bubbler Parts	208
Bucket	63-66
Bucket	66
Bulb	
CFL	109, 113-115
Chandelier	107-111, 124, 125
Exit	107
Flood	112, 125-128
Fluorescent	118-122
Halogen	109, 110, 113-115, 123-128
HID	129, 130
Incandescent	107-112
LED	107-115, 118, 120-128, 130
Miniature	107, 108
Bulb Changer	111
Bungee Cord	330
Cabinet	
Drawer Hardware	313, 329
Fire Extinguisher	277
Hardware	313, 329
Key	290
Vanity	314
Cable Jacks & Accessories	139
Cables, Snake	347
Cable Ties	132
Cable Wire	133
Canister Vacuum	74, 75
Capacitors, Motor - Run	247
Carpenters Glue	321
Carpet	79
Carpet Cleaner	22, 23, 25
Carpet Extractor	85
Carpet Mask	79
Carpet Spot Remover	23
Carpet Sweeper	60
Carpet Trims	311
Carf	14-17
Cartridge	189-191, 193-197, 200-206, 257
Carts, Housekeeping	14-17
Carts, Janitor	14-17
Casement Hardware	309
Caulking	326
Caulking Gun	327
Caulking Tool	327, 328
Caution Sign	66, 278
Caution Tape	331
Ceiling	
Fan	86
Fixture	87-92, 97-100
Hanger	310
Register	270
Tile	310
Cement	322
ABS	320
Contact	322
PVC	320

CFL Bulb	109, 113-115
CFL Lamp Holder	120
Chandelier	92
Check Valve	172, 262
Chemical Management	54
Chicago Repair Part	189
Chime Kit	146
China Sink	158
Chisel	344
Clamps, Copper Pipe Repair	169
Clamps, Hose	168, 169
Cleaner	
Appliance	32-35
Carpet	22, 23
Degreaser	29-31
Dishwasher	33, 34, 235
Disinfectant	25-28, 46, 47
Eco Friendly	19-31, 37, 39, 41, 45-49
Floor	18, 21, 22, 26, 27
General	25-31
Glass	37
Hand Care	38, 39, 40-44
Laundry	35
Multi-Purpose	24-27, 29
Odour	49-52
Specialty	36, 38
Surface	24-29
Washroom	45-48
Window	37
Cleaning	8-84
Closers, Door	300
Closet Bolts	150
Closet Door	287
Closet Hardware	301-303
Closet Rod	301
Closet Shelving Hardware	301
Clothing Protection	281
CO Detector	144
Coil Cleaner	276
Coil Units	Website
Coin Chute	224
Comet Cleaner	24, 26
Comfort-Aire Air Conditioners	Website
Commercial	
Door Hardware	296-299
Fan	274
FastDraw	54
Faucet	182-188
Faucet Part	183, 184, 186, 187
Floor Machine	80-83
Flush Valve	209, 210
Toilet	147, 148
Urinal	147
Compact Fluorescent Lamp	113-115
Compression Fitting	172, 173, 175
Compressor Motors	Website
Compressors	Website
Condensation Pump	221
Condenser Motor	245
Condenser Units	245
Conduit	Website
Connectors, Hose	334
Connectors, Wire	132
Contact Cement	322
Contactors	247
Controls, Heat	251-258, 264-266
Conversions, Thermostat	253
Cooling Fan	86
Copper Pipe	170
Copper Pipe Fitting	170, 172
Copper Pipe Repair	169, 170, 172
Copper Tubing	Website
Cord End	140
Cordless Tools	350-352
Cords, Extension	140
Cotton Mop	64, 65
Coupler	169
Couplers, Hose	169
Couplers, Pump	260, 261
Coveralls, Disposable	281
Covers, Electrical	133, 134, 138, 139
Covers, Exhaust Fan	244

Covers, Thermostats.....	267
Crane	
Bathroom Sinks.....Website	
Faucet Part.....	201
Flush Valve Part.....	212
Toilet Parts.....	150-156
Toilets.....Website	
Urinals.....Website	
Crane Repair Parts.....	200, 201
Cream, Skin.....	38
Crescent Wrench.....	343
Crimping.....	343
Crimping Tool.....	171
Crisper.....	228
Croc Bloc.....	283
Curtain Hardware.....	311
Cuthbert Repair Part.....	190
Cutoffs, Low Water.....	259
Cylinders (Mortise).....	297
Damper.....	238, 256
Danfoss Radiator Valve.....	258
Dap Silicone.....	326, 327
Deadbolt.....	288, 296, 298
Deadlatch.....	298
Debonaire Hand Soap.....	40
Deck Repair Plates.....	186
Degreasers.....	30, 31
Dehumidifiers.....	275
Delany Flushmeter.....	212
Delany Repair Part.....	212
Delta	
Faucet.....	178, 180-183
Flushmeter.....	210, 211
Flushmeter Repair Part.....	210, 211
Repair Parts.....	191, 192, 210
Detectors, Smoke, CO.....	143, 144
Detergent, Laundry.....	35, 234
Diaper Disposal	
Baby.....	67
Incontinence.....	67
Diaper Station.....	67
Digital Tester.....	353
Digital Thermostat.....	265, 266
Dimmer.....	136, 137
Dip Tube, Hot Water Tank.....	223
Direct Drive Motor.....	245, 246
Dish Rinse Aid.....	33, 34, 235
Dishwasher.....	227
Detergent.....	33, 34
Drain Hose.....	235
Hook Up Kit.....	235
Install Kit.....	173
Parts.....	235, 236
Disinfectant.....	25-28, 47
Dispenser	
Diaper Disposal.....	67
Hand Cleaner.....	40-44
Paper.....	69, 70
Sanitary Napkin Disposal.....	67
Tampon Disposal.....	67
Dispensers, Hand Soap.....	40-43
Disposable Glove.....	55
Disposal.....	224
Diverter.....	191-197, 202, 203, 206
Doggie Station.....	332
Dogipot.....	332
Dog Waste Station.....	332
Doktor Doom.....	284, 285
Dolly.....	16
Door.....	287
Blocker.....	293
Chain.....	308
Chime Kit.....	146
Closer.....	300
Closet Hardware.....	301-303
Deadbolt.....	288, 296-298
Guard.....	293
Guards.....	293
Hinge.....	292, 299, 313, 319,
Interior.....	287
Knob.....	288, 296, 318
Latch.....	289, 297, 298, 308, 318, 319

Lever.....	288, 296, 297
Lock.....	288, 296-298
Lock Defender.....	293
Lockset.....	288, 296, 297
Numbers.....	301
Security.....	291, 293
Sets, Taymor.....	288, 296
Sliding Glass Parts.....	304
Sliding Screen Parts.....	305-307
Spring.....	291, 308
Stop.....	291, 298
Strike.....	289, 298, 308
Sweep.....	294
Threshold.....	294
Viewer.....	291
Weatherstripping.....	295
Wrap Arouds.....	293
Door Commercial Hardware.....	296-300
Deadbolt.....	288
Doorbell.....	146
Drain Cleaners/Opener.....	48
Drain Cleaning Equipment....	347, 350, 351
Drawer Glide.....	313
Drawer Knob.....	329
Drawer Pull.....	329
Drill.....	350, 351
Drill Bit.....	354-357
Driver Bits.....	342, 354-356
Dryer	
Dyson.....	68
Floor.....	80
Hand.....	68
Venting.....	237, 238
Dryer Duct Supplies.....	237, 238
Dryers, Clothes.....	227
Duct Tape.....	323
Dustbane Cleaning Product..	18-29, 32-39,
.....	43, 45-51, 53
Dustbane Vacuum.....	75, 76
Duster.....	58
Dust Mask.....	280
Dust Mop.....	60, 62, 63
Dust Pan.....	60
Dyson Air Purifier.....	68
Dyson Hand Dryer.....	68
Ear Muffs.....	280
Ear Plugs.....	280
Easy Link Couplers.....	260
Easy Off Oven Cleaner.....	32
Electrical	
Box.....	133, 134
Connector.....	132
Cover.....	133, 134, 138, 139
Tape.....	323
Tools.....	133
Electric Heater.....	245
Electric Strike.....	298
Electronic Faucet.....	182, 185, 187
Electronic Flushmeter.....	209, 210
Elements, Hot Water Tank.....	223
Elements, Range.....	229, 231, 232
Emco Faucet.....	180
Emco Repair Part.....	194
Emergency	
Lamps.....	107
Lighting.....	106
Lighting Batteries.....	142
Remote Head.....	106
Safety.....	277-281
Sign.....	106
Signs.....	278
End Cap, Fridge.....	228
Energizer Product.....	141, 142
Energy Efficient Lighting Fixture....	87-104
Entry Mat.....	79
Enviro. Friendly Chemical	18-33, 37, 39-49
Epoxy.....	320
Erie Zone Valve.....	255
Exhaust Fan.....	239-241, 243
Exit Bulb.....	107
Exit Lighting.....	106
Exit Sign.....	106, 278

Expansion Tank.....	259
Extension Cord.....	140
Extension Pole.....	56, 111
Extinguisher.....	277
Extractor.....	85
Tools.....	85
Eye Protection.....	279
Eye Wash.....	279
Sign.....	278
E Z Reacher.....	335
Facial Tissue.....	73
Fan and Limit Controller.....	249
Fan Coil/Blower Motor.....	245
Fan Control.....	249
Fans	
Bathroom.....	239-244
Ceiling.....	86
Commercial.....	274
Floor.....	274
In Line.....	238
Oscillating.....	274
Pedestal.....	274
Fantastik Cleaner.....	24
FASTDRAW.....	54
Fastener.....	329
Faucet.....	177-180, 182-188
Bathroom.....	179-187
Electronic.....	182-187
Kitchen.....	177, 178, 188, 184
Faucet Install Kit.....	173
Faucet Part.....	184, 186-206
Faucet Parts, Uberhaus.....	206
Faucet Repair Part.....	206
Faucet Tub/Shower.....	181
Febreze.....	51
Felt Pad.....	329
Felt Slide.....	329
Feminine Hygiene.....	67
Fernox Boiler Treatment.....	263
Fertilizer Spreader.....	336
Fiat Faucet Repair Part.....	195
Filler.....	328
Filter	
Air.....	268, 269
Air Conditioner.....	268, 269
Air Merv 8.....	269
Air Merv 10.....	269
Air Merv 11.....	269
Air Merv 13.....	269
Boiler.....	263
Fiberglass.....	269
Fridge.....Website	
Furnace.....	268, 269
Hammock.....	268
Humidifier.....	271
Poly Media.....	268
Throw-Away.....	268
Vacuum.....	78
Water.....	208, 263
Water Cooler.....	208
Filter Frame.....	269
Fire Alarm.....	143, 144, 277
Fire Alarm Pull Station.....	277
Fire Extinguisher.....	277
Fireplace Cleaner.....	36
Fireplace Parts.....Website	
Fire Safety Plan Box.....	277
Fire Safety Sign.....	278
First Aid Kit.....	279
Fitter, Light.....	104
Fittings	
ABS.....	167, 168
Brass.....	170-174
Compression.....	172, 174
Copper.....	170
Pex.....	171, 172
Plumbing.....	167-174
Rubber.....	169
Flame Sensors.....	248
Flanges, Wall.....	174
Flange, Toilet Floor.....	150
Flange, Wall.....	174

Flange Washer.....	161
Flashlight.....	141, 351
Flexible Coupling.....	169
Flexible Supply Line.....	173
Floater, Pump.....	221
Floodlight.....	102, 103, 112, 126-128
Floor	
Absorbent.....	21
Care Cleaners.....	18-23
Detergent.....	18, 22
Equipment..	59, 60, 62-64, 76, 81, 83, 84
Fan.....	274
Finish.....	19, 20
Maintainer.....	21
Mats.....	79
Mop.....	62-65
Pad.....	62-64, 81
Polishing Machines.....	82, 83
Polishing Pads.....	81
Register.....	270
Scraper.....	61
Sealer.....	19
Signs.....	66
Squeegee.....	61
Stripper.....	18
Floor Machine.....	80, 82-85
Flow Switch.....	259
Fluorescent	
Compact.....	113-115
Lamp Holders.....	119
Lamps.....	118, 119, 121
Lamps, CFL.....	113, 114, 115
Lamps, Circline.....	119
Lamps, Linear.....	117, 118
Lamps, Plug in.....	113, 114, 115
Lamps, T5.....	118, 119
Lamps, T8.....	119, 121
Lamps, T9.....	119
Lamps, T12.....	121, 122
Lamps, U Shaped.....	121, 122
Light Fixture.....	94
Light Fixtures.....	97, 98
Strips.....	94, 97, 98
Flushmeter.....	209-220
Flushmeter Part.....	209-220
Flush Valve, Toilet...	154, 209-213, 216, 217,
.....	219, 220
Fly Trap.....	286
Foam Sealant.....	327
Foam Tape.....	295
Food Service Faucet.....	188
Foot Cream.....	38
Foot Valves.....Website	
Fountain.....	207
Fountain Repair.....	208
Fridge.....	225
Fridge Parts.....	228
Furnace	
Belt.....	267
Control.....	249
Fan Motors.....	246
Filters.....	268, 269
Ignitors.....	248
Parts.....	246, 247, 248, 249
Thermostats.....	265, 266
Furnace Furniture Polish.....	38
Fuse.....	131
Garbage Bags.....	12
Garbage Bag Stand.....Website	
Garbage Can.....	8-11
Galvanized.....	11
Lids.....	8
Recycle.....	9
Rubbermaid.....	8-11
Garbage Can Caddy Bag.....	8
Garbage Can Dolly.....	8
Garburator.....	224
Garden Care Product.....	335
Garden Glove.....	282, 283
Garden Hoses.....	334
Gardening.....	335
Gas Can.....	335

Gas Valve.....	250
Gate Hardware.....	330
Gauge, Pressure.....	264
Gauge, Temperature.....	264
General Purpose Cleaner.....	24-31
General Wire Snake.....	347
Germicidal.....	26
GFCI (GFI).....	135
Glass Cleaner.....	37
Glasses, Safety.....	279
Glass, Fixture.....	104
Glass Sliding Door Hardware.....	304
Glide, Window.....	308
Globe, Outdoor Fixture.....	104
Globe, Poly.....	104
Gloves	
Disposable.....	55
Latex.....	55
Rubber.....	55
Winter.....	283
Work.....	282
Glue.....	320-322
Glue Remover.....	325
Glycol.....	263
GNN Fan.....	239
Go Jo Hand Cleaner.....	38
Goof Off.....	36, 325
Goo Gone.....	36
Gorilla	
Adhesive.....	322
Glue.....	321
Silicone.....	326
Tape.....	323
Grab Bar.....	317
Graffiti Remover.....	36
Graphite.....	289, 325
Grease, Faucet.....	324
Grease Monkey Glove.....	55
Grease Traps.....	Website
Greenwald Coin Chute.....	224
Grinder.....	351, 352
Grout.....	328
Grout Brush.....	56
Grout Cleaner.....	46, 47
Grout Tool.....	354
Gum Remover.....	36
Hacksaw.....	346, 350
Halogen	
Lamps.....	128
Lamps, Mini.....	123
Lamps, MR16.....	124, 125
Lamps, Par.....	128
Hammer.....	344
Hand	
Carts.....	14-17
Cleaner.....	39-44
Cloths.....	58, 72, 73
Dryers.....	68
Sanitizers.....	27, 28, 44
Shower.....	165, 166
Soap.....	39-43
Soap Dispensers.....	40-43
Soap Refills.....	41, 42
Towel Dispensers.....	69
Towels.....	72, 73
Wipe.....	27, 28, 38
Handle Acrylic.....	192, 198
Handle Faucet.....	192, 194, 195, 198
Handle Lever.....	198, 200
Handle Puller.....	345
Handles	
Broom.....	61
Commercial Door.....	297
Cupboard.....	329
Drawer.....	329
Faucet.....	181, 190-198, 201-204
Mop.....	61, 62, 63, 64
Patio Door.....	304, 306
Rubbermaid.....	62
Screen Door.....	306, 308
Storm Door.....	308
Toilet.....	156, 157
Window.....	309

Handle Tub/Shower.....	198, 203
Handrail Bracket.....	310
Hard Hat.....	280
Hasp.....	330
Headlight.....	141
Hearing Protection.....	280
Heated Jacket.....	348
Heater.....	245, 273
Heat Gun.....	352
Heating & Air Conditioning... 239-243, 272	
Heating Controls.....	247-258, 265, 266
Hedge Trimmers.....	335, 349
H.I.D.	
Ballast.....	117
Fixture.....	102, 103
Lamp.....	129, 130
High Pressure Sodium Fixture.....	102, 103
High Pressure Sodium Lamp.....	129, 130
Hinge Door.....	292, 299, 318, 319
Hole Saw.....	355
Honeywell	
Air Vents.....	258
Filters.....	269, 271
Furnace Parts.....	248-250
Humidifiers.....	271
Pneumatic.....	253
Thermostats.....	253, 265, 266
Zone Valves, Electric.....	255
Hoodies.....	348
Hose Bibb.....	174
Hose Clamp.....	168, 169
Hose Clamps.....	168
Hose, Dishwasher.....	235
Hose Dryer.....	237, 238
Hose, Flex.....	172, 173, 234, 235
Hose Kit, Pump.....	221
Hose Reels.....	334
Hose Repair.....	333
Hoses, Garden.....	334
Hose, Shower.....	165, 166
Hose, Washer.....	234
Hospco Odor Control Product.....	51
Hot Water Tank.....	223
Hot Water Tank Element.....	223
Hot Water Tanks & Parts.....	223
Hot Water Tank Valve.....	223
Housekeeping Carts.....	14-17
House Number.....	301
Humidifiers Parts.....	271
HVAC.....	239-273, 276
Hydronic Heating.....	255-266
Hydronic Zone Valve.....	255
I Beam.....	311
Ice Chipper.....	337
Ice Cleats.....	281, 336
Icemelt.....	336
Ignition Module.....	249
Ignitor.....	248
Incontinence Product.....	67
Infrared Temp Gun.....	353
In Line Fan.....	238
Insect Killer.....	284, 285
Inspection Camera.....	353
Inspection Mirror.....	344
Installation Kit.....	173
Intercom Station.....	146
Interior Door.....	287
Jacket.....	348
Jameco Repair Part.....	195
Janitor Caddy.....	58
Janitor Carts.....	14-17
J Bend.....	161, 169
JeldWen Doors.....	287
Jigsaw.....	351
Jig Saw Blade.....	354
Joint Compound.....	320, 328
Key	
Blanks.....	289
Boxes.....	290
Cabinets.....	290
Machines.....	289
Ring.....	290
Tag.....	290

Keying	
Pin.....	289
Tool.....	289
Kit.....	289
Tool.....	289
Key Keeper.....	290
Kickplate.....	293
Kidde Smoke Alarm.....	143, 144
Kilz.....	338
Kimberly Clark Wiper.....	58
Kindred Kitchen Sink.....	159
Kitchen	
Sink Drain.....	160-162
Sink Faucets.....	177, 178, 188
Sink Repair.....	160-162
Sinks.....	159
Sink Stoppers.....	162
Kleenex.....	See Facial Tissue
KMC Volume Controller /Parts.....	254
Knife Blades.....	341
Knives.....	341
Knob, Door.....	288, 296
Knobs, Cabinet.....	329
Knobs, Diverter.....	193
Knobssets.....	288, 296
Kohler Repair Part.....	151-153, 195
Krylon.....	338
Ladder.....	331
Lamp Shades.....	89
Lamp Socket.....	105
Lanyard.....	281
Latex Glove.....	55
Laundry Detergent.....	35
Laundry Sink.....	159
Lavatory Faucet.....	179-187
Lawn and Gardening.....	335
Lawn Care.....	335
Leak Detector.....	324, 346
L.E.D. Emergency Lamp.....	106, 107
L.E.D. Fixture.....	87-99, 101-103, 106
L.E.D. Grid Troffer.....	99
L.E.D. Lamps (bulbs) 107-109, 114, 120, 130	
Lense.....	104, 105
Lepage.....	320-322, 327, 328
Level.....	344
Lever.....	288, 296, 297
Lever Handle.....	192
Lid, Garbage.....	8, 9
Light Bulbs.....	See Bulbs
Light Fixture.....	87-90, 92-104, 106
Light Switch.....	135, 136, 138
Lime Remover.....	34, 45-47, 263
Line Stripping Paint.....	338
Lip Balm.....	38
Litter Picker.....	60, 335
Litter Scoop.....	60
Little Giant Pump.....	221, 222
Lock, Mailbox.....	312
Locksets.....	288, 296, 297
Lock, Window.....	308, 309
Loctite.....	321
Lopper.....	335
Lubricant.....	324, 325
L.W.C.O. Switch.....	259
Lysol Cleaner.....	24, 27, 45
Lysol Toilet Bowl Cleaner.....	45
Lysol Wipe.....	27
Machine Pads.....	81
Magnetic Tray.....	342
Maid O Mist.....	258
Mailbox.....	330
Mailbox, Commercial.....	312
Mailbox Door Locks.....	312
Mailbox, Residential.....	312
Make Up Fan Coil Motor.....	245, 246
Mapp Gas.....	346
Mask, Dust.....	280
Masking Tape.....	323
Mask, Respirator.....	280
Material Handling.....	11, 14-17
Mating.....	79
McDonnell & Miller.....	259
Medicine Cabinet.....	314

Metal Cleaner.....	35
Metal Halide Fixture.....	102, 103
Metal Halide Lamp.....	129
Meter, Amperage.....	353
Meter, Voltage.....	353
Microfiber Bucket.....	63
Microfiber Cloth.....	34, 58
Microfiber Mitt.....	57
Microfiber Mop.....	62-64
Microwave.....	226
Milwaukee Power Tools.....	349-352
Milwaukee Tools.....	348, 350-357
Mircom Intercom Station.....	146
Mircom Smoke Detectors.....	Website
Mirror.....	314
Mirror Clip.....	314
Mirrored Doors.....	Website
Mixet Repair Part.....	196
Mixing Valve.....	172, 182-184, 186, 187
Module, Furnace.....	249
Moen Faucet.....	177-181, 184
Moen Flushvalve.....	216
Moen Repair Part.....	155, 181, 184, 197-199, 216
Moen Toilet Part.....	155
Mop	
Bucket.....	63, 64, 65, 66
Floor.....	62, 63, 64, 65, 66
Frame.....	60
Handles.....	61, 62, 63, 64
Head.....	61, 62, 63, 65
Kits (Vileda).....	63, 64
Microfiber.....	62, 63
Moto.....	80
Sink.....	159
Sink Faucets.....	182-184, 188
Sponge.....	64
Wall.....	57
Yacht.....	64
Motion Sensor.....	102, 138
Motor	
Boiler.....	260, 261
Condenser.....	245
Direct Drive.....	246
Fan Coil.....	245, 246
Furnace.....	246
Pump.....	260, 261
Range Hood.....	233
Unit Heaters.....	246
Zone Valve.....	255
Motor Belt.....	267
Motorola Radio.....	146
Motor Pulley.....	249
Motors	
Bathroom Fan.....	239-243
Condenser.....	245
Fireplace.....	Website
Mouse Trap.....	286
Mr. Clean Cleaner.....	21, 27
Mr. Clean Eraser.....	57
Napkin.....	73
Napkin Dispenser.....	69
Napkin Disposal.....	67
Niagara Toilet Part.....	151, 155, 156
Niagara Toilets.....	Website
Nitrile Glove.....	55
No More Nails.....	321-323
Non Contact Thermometer.....	353
Non Freeze Wall Hydrant.....	176
Novanni Sinks.....	Website
Numbers.....	301
Nut Driver.....	356
Occupancy Sensor.....	102, 138
Odour Control.....	49, 50
Odour Control Dispenser.....	51, 52, 216
Odour Control Product.....	49-52, 216
Oil.....	324, 347
O'Keeffe.....	38
Oscillating Fans.....	274
Oscillating Sprinklers.....	333
Outdoor	
Fixture Globe.....	101
Glass Cleaners.....	37

Power Equipment	349
Wall Fixtures	101-103
Window Cleaners	37
Oven	226
Oven Cleaner	32
Pad Lock	330
Pads, Floor	81
Paint	338
Brush	339
Remover	325
Roller	339, 340
Tray	339
Painters Tape	323
Panasonic Fan	239
Panels	99
Paper	71-73
Paper Dispenser	69, 70
Paper, Toilet	71
Paper Towel	58, 72, 73
Paper Towel Dispensers	69
Parking Lot Stripping Paint	338
Part Box	344
Partition Hardware	318, 319
Pedestal Fans	274
Peerless Faucet	177-180
Pest Control	284-286
Pet Station	332
Pex Fittings	171, 172
Phone	146
Phone Jack	139
Photocell	101-103, 145
Photoelectric Smoke Alarm	143, 144
Pine Cleaner	27, 29
Pine Sol	27
Pins (Lock)	289
Pipe Cutter	345, 350
Pipe Joint Compound	320
Pipe Wrench	344
Pivot	299
PL Adhesive	322
Pleated Air Filter	269
Pledge	38
Plier	343
Pliers	343, 344
Plug-Ins	134, 135
Plug Plate	134, 135, 138, 139
Plumbers Putty	320
Plumbing Parts	
American Standard	147, 151, 152, 154
Aquadis	189
Aqua Dynamic (B&K)	189
Belanger (Cuthbert)	190
Bradley	190
Chicago Faucets	189
Crane	152, 200, 201, 212
Cuthbert	190
Delany	212
Delta	163, 165, 181, 191, 192, 210, 211
Emco	194
Encore	194, 195
Fiat	195
Galtmaster	195, 196
Jameco	195
Kohler	151, 152, 156, 195
Mixet	196
Moen	181, 184, 197-199
Mueller	196
Powers	200, 201, 212
PowersCrane	200, 201
Price Pfister	202
Sloan	147, 204, 213-215
Sterling	203
Symmons	203
Tempress	206
Toto	153, 154, 157, 186, 205
T&S Brass	188, 204
Uberhaus	206
Valley	206
Wallaceburg	206
Waltec	192, 193
Zum	187, 220

Plumbing Tools	345-347, 350
Plunger	48, 345
Pneumatic Parts	250-254
Pneumatic Thermostat	250-253
Pneumatic Valve	250, 252-254
Pneumatic Valves	252
Pop Up	160, 162, 164
Portable Air Conditioners	275
Pot Light	90
Powder, Ant & Insect	285
Powers/Crane Repair Parts	152, 212
Power Snake	347, 350
Powers Repair Parts	200, 201, 212
Pre Rinse Spray	188
Pressure Gauge	264
Pressure Plumber	48, 345
Pressure Regulator	262, 263
Pressure/Relief Valve	262, 263
Pressure Switch	250
Pressure Towel Repair Part	202
Propane	346
Proportioning System	53
ProTeam	75
Proximity Faucet	182-185, 187
Pruning Tool	335
Pry Bar	344
P Trap	161, 169
Pulleys, Motor	249
Pulls, Cabinet	329
Pulls, Handle	329
Pull Station	277
Pump	
Armstrong	261
Bell & Gossett	260
Boiler	260, 261
Circulating	260, 261
Little Giant	221, 222
Portable	221, 222
Sump	222
Taco	Website
Vacuum	276
Pump Accessories	221, 222
Pump Float	221
Pump Part	260, 261
Purell Hand Sanitizer	28, 44
Purifier	68
Push Fit Fittings	172
Putty Knife	339
PVC Cement	320
R414B	276
R422C	276
Rack, Bike	332
Radiator Valve	258
Radio	146
Radios, Two Way	146
Rag	34, 58
Rake	335
Range	226
Bowls & Rings	230
Hood, Motor	233
Hoods, Broan	233
Hoods, Filters	233
Parts	229-232
Surface Element	229
Ratchet Wrench	345
Reacher	335
Receptacle	134, 135, 137, 230, 232
Receptacle Plate, Wall	134, 135, 138, 139
Reciprocating Blade	355
Reciprocating Saw	351, 352
Recycle, Bags	12
Recycle Container	9
Refrigerant	276
Refrigerator	225
Register, Floor	270
Regulator Valve	262, 263
Rekeying	289
Relay	247
Relief Valve	262, 263
Remover	23, 36, 46, 325
Replacement Glass	104
Reset Volume Controller	254

Respirator Mask	280
Return Air Grill	270
Reversomatic Bath Fan	240
Reversomatic Fan Part	243, 244
Rinse Aid	33, 34
Robe Hook	315
Rod	301, 303, 316
Rope Grab	281
Rope Lights	Website
Rubber Gloves	55
Rubbermaid Cart	14-17
Rubbermaid Custom Refuse	9
Rubbermaid Garbage Can	8-11
Rubber Mallet	344
Run Capacitor	247
Rust Remover	24, 45-48
Safety	
Back	281
Body Harness	281
Clothing	281
Glasses	279
Head Protection	280
Hearing Protection	280
Knee	281
Respiratory	280
Safety Cone	66, 280
Safety Relief Valves	262
Salt	336
Sand Paper	340, 346
Sand & Salt Bin	336
Sanitaire	
Bags/Parts	77, 78
Extractor	85
Floor Machines	76
Vacuum	75, 76
Saw	346, 350-352
Saw, Circular	351, 352
Saw Horse	331
Sawzall	351, 352
Sawzall Blade	354, 355
Scouring pad	57
Scrapers	
Caulking	328
Floor	61
Grout	354
Ice	337
Putty	339
Screen Cleaning Tool	307
Screen Door Hardware	305-307
Screen Edging	307
Screening	307
Screen Sliding Door Hardware	305-307
Screw Driver	342
Screws	Website
Scrub Pad	57
Sealant	326, 327
Sealed Lead Batteries	142
Sealer	19, 20
Seasonal	333, 334, 336
Seat	195, 201
Seat, Faucet	189-191, 193-196, 201, 203-206
Seat, Toilet	149
Seat Wrench	345
SEEK	353
Sensi Thermostat	266
Sensor, Electric Light	102, 138
Sensor Faucet	182-185, 187
Sensor Flushmeter	209-220
Sequencers	250
Service Sink Faucet	182, 184, 188
Shades	89
Shaft, Blower	249
Sharkbite Fittings	172
Shears	335
Sheave	249
Shelf Bracket	301
Shelf Support	301
Shoe Covers	281
Shoes (Pilaster)	319
Shop Vac	74

Shovels	
Summer	335
Winter	337
Shower	
Curtain	316
Curtain Rod	316
Faucets	181
Showerhead	165, 166
Shower Rod	316
Siemens Thermostat	252
Siemens Valve	252
Sign	66, 106, 278
Silicone	326, 327
Lubricant	324
Remove	325
Sink	
American Standard	158, 159
Kindred	159
Kitchen	159
Laundry	159
Mop	159
Vanity (Bathroom)	158, 159
Wall Hung	159
Sink Legs	159
Sink Repair	160-162
Sink Tailpiece	160
Skin Care	39
Slide Dimmer	136
Sliders, Felt	329
Sliding Glass Door Hardware	304
Sliding Screen Door Hardware	305-307
Slip Joint Nut	161
Slip Joint Washer	161
Sloan Faucet	185
Sloan Flushmeter	213
Sloan Flushmeter Repair Part	213-215
Sloan Waterless Urinal Filter	147
Smartkey Lockset	288
Smoke Alarm	143, 144
Smoke Alarm Tester	144
Smoke Detector	143, 144
Snake	347, 350
Snake Cable	347
Snips	343
Snow Shovel	337
Snuggle	Website
Soaker Hose	334
Soap Holder	40, 43, 316
Socket, Light	104, 105
Socket, Tool	356
Solder	346
Soldering Flux	346
Solder Paste	346
SOS Pad	57
Space Heater	273
Spackling	328
Spic & Span Cleaner	21
Spiral Lamp	109
Spirotherm	259
Sponge	57
Sponge Mop	64
Spot Cleaners	80
Spot Clean Extractor	80
Spot Remover	23, 36
Spout	
Kitchen	188, 193, 194, 199
Tub	163
Spray	
Adhesive	321
Bottle	53
Bottle Trigger	53, 54
Foam, Expanding	327
Guns	Website
Trigger	53
Sprayers, Hose	333
Sprayers, Pumps	53, 54
Spray Nine	24
Spray Paint	338
Spreader	334, 336
Spring	
Door Chain	308
Door Stops	291

Door Closer	300, 308
Hinge	292
Sprinklers	333
Spud Wrench	345
Squeegees	
Floor	61
Window	56
Stainless Steel Cleaner	35
Start Capacitor	247
Starter, Fluorescent Lamp	116, 117
Steel Wool	57
Stern	191, 193-196, 201-203
Step Ladder	331
Step Stool	331
Stoppers, Bathroom Sink	162
Stoppers, Kitchen Drain	162
Stoppers, Tub Drain	164
Storm Door Hardware	308
Stove	226
Strip Light	94-98
Stucco	328
Sump Pump	222
Sunlight Detergent	33
Sunscreen	283
Supply Lines	
Dishwasher	173, 235
Faucet	173
Toilet	173
Surface Care	24-31
Surge Protector	140
Sweeper, Carpet	60
Sweeping Compound	21
Swiffer	58, 63
Switch	135-138
Switch Plate, Wall	136-138
Symmons Repair Parts	203
T5 Lamp	118, 119
T8 Lamp	119, 120, 121
T9 Lamp	119
T12 Lamp	121, 122
Tampon Disposal	67
Tank, Expansion	259
Tank, Toilet	148
Tape	
2 Sided	323
Anti Skid	331
Caution	331
Duct	295, 323
Duct & Foil	323
Electrical	323
Foam	295
Masking	323
Measure	344
Packing	323
Painters	323
Teflon	323
Taski Pro Vacuums	Website
Taymor Door Closer	300
Taymor Door Set	288
Tech. Concepts Flushmeter Clamp	216
Technical Concepts Hand Soap	40
Teck Repair Part	210, 211
Teflon Spray	324
Teflon Tape	323
Temperature Gauges	264
Temperature Sensor	254
Temperature Testers	353
Tempering Valves	262
Tempress Repair Part	206
Terminal	132
Tester, Digital	353
Thermal Imaging Camera	353
Thermo Aqua Stats	264
Thermocouple	223, 248
Thermometer, Non Contact	353
Thermometers	264
Thermopiles	248
Thermostat	265, 266
Covers	267
Digital	265, 266
Furnace	265, 266
Hydronics	265
Pneumatic	250-254, 266

Thermostatic Valve	182-184
Tie Down	330
Tiger Oven Cleaner	32
Tiles, Ceiling	310
Tilex	47
Timer	145
Tin snips	343
Tin Snips	343
Tissue Paper	71, 73
Toilet	
Ballcocks	155, 156
Bowl Brush	56
Bowl Cleaner	45
Flappers	152, 153
Floor Flanges	150
Flushvalves	154, 212, 216, 217
Install Kit	150
Paper	71
Paper Holder	70, 315, 316
Plunger	345
Repairs	149-157
Seat Cover	67
Seats	149
Snake	347, 350
Tank Gasket	151, 152
Tank Lever	156, 157
Toilets, American Standard	147, 148
Tool	
Bag	357
Bits	354-357
Blades	354
Box	344
Brushes	339
Cartridge	345
Caulking Gun	327
Cordless	350-352
Digital Testers	353
EZ Reach	335
Fasteners	Website
Grout	328, 354
Hand Tools	341-347, 350-357
Hex Sets	343
Hole Saw Bits	355
Hoses	334
Lawn Care	333-335
Knives	341
Paints	338
Pliers	343
Plumbing	343, 347, 350
Power	350, 351, 352
Pruning	335
Rake	335
Rollers	340
Sand Paper	340
Screwdrivers	342
Shovels	335, 337
Snakes	347, 350
Soldering	346
Sprayers	53, 54
Tape	323
Trays	339, 340
Valve	176, 252, 345
Wrench	343, 345
Torch	346
Toto Faucet	186
Toto Flushometer	217
Toto Flushometer Parts	217, 218
Toto Toilet Parts	154, 155, 157, 217, 218
Touchup Paint	338
Towel Bar	315
Towel Ring	315
Towels, Paper	72, 73
Track Lighting	96
Traffic Cone	280
Traffic Vest	281
Transformer	117
Trimmer	335
Troffer	99
Trouble Light	140
T&S Faucet	188
T&S Faucet Parts	204
TSP	325

Tub	
Adhesives	322
Door	163
Drain Stoppers	164
Overflow Kits	164
Showerheads	165
Spouts	163
Surrounds	163
Tub & Shower Faucet	181
Tub & Shower Repair	163-166
Tub & Tile Cleaner	46, 47
Tub Waste & Overflow	164
Turpentine	325
Two Way Radios	146
Uberhaus Faucet Parts	206
Under Cabinet Lighting	Website
Upright Vacuum	76
Urinal	147
Cleaner	45-48
Flushmeter	209-220
Gasket	147
Puck	48
Screen	48
Snake	347
Spud	147
USB Charger	134
USB Receptacle	134
Utility Faucet	178, 182-184, 188
Utility Knives	341
Vacuum	74-76
Accessories	74, 75, 77, 78
Bags	77
Breaker	174, 210-220, 263
Breaker, Hydrant	174, 176
Key	176
Parts	74-78
Valley Repair Part	206
Valve	262
Boiler	262, 263
Check	172, 176
Feed Water	262
Gas	250
Gauges	264
Key	345
Mini Ball	172, 174, 175
Partition Stop	176
Pneumatic	252, 253, 254
Pressure	262, 263
Regulator	262, 263
Relief	263
Safety	262
Sediment Faucet	174
Tempering	262
Thermostatic	182, 184, 186, 262
Zone	255
Vandalism Cleaner	36
Vanity	
Faucets	179, 180, 182-186, 187
Light	94, 95, 96
Mirrors	314
Sinks	158
V Belts	267
Venting, Dryer	237, 238
Vents, Air & Scoop	258
Vieda Mop Kits	63, 64
Vim Toilet Bowl Cleaner	45
Vinyl Gloves	55
Voltage Meter	353
Wall	
Fans	275
Heaters	245
Hung Sink	159
Plates	139
Receptacle	134, 135
Registers	270
Sconces	93
Thermostats	265, 266
Timers	145
Wallaceburg Repair Part	206
Waltec Faucet	177, 178, 180, 181
Waltec Repair Part	192, 193

Wash Bucket	65, 66
Washer, Appliance	227
Washer, Faucet	201
Washer Hose	234
Washing Machine Hose	234
Washing Machine Parts	Website
Washroom	See Bathroom
Wastebaskets	10, 11
Waste Cans	8-11, 14
Waste & Overflow	164
Waste Stations, Pet	332
Water	
Alarm	221
Cooler Bubblers	207
Filter	208, 263
Fountains	207
Heaters & Parts	223
Matrix Part	151, 153, 154
Pumps	221, 222, 260, 261
Watts	
Backflow Preventer	263
Mixing Valves	262
PRV	262
Regulator Valves	262
SRV	262
Tempering Valves	262
Wax Seal	147, 150
Wax	See Floor Finish
WD40	324
Weatherstripping	294, 295
Weed Whipper/Trimmer	349
Weiser Door Set	288
Wet Mop	62, 63, 65
Wheel Barrows	334
Wi-Fi Switches	137
Wifi Thermostat	245, 266
Windex	37
Window	
Air Conditioners	275
Awning Hardware	309
Casement Hardware	309
Frame	307
Glide	308
Screen	307
Slides	308
Squeegee	56
Washing Bucket	66
Winter	
Gloves	283
Icemelt	336
Shovels	337
Wear	348
Wiper	34, 58
Wireless Thermostat	266
Wire Nuts	132
Wire Stripper	133, 343
Wiring	133
Wood	
Cleaner	38
Glues	321
Handle, Tapered	61
Handle, Threaded	61
Polish	38
Wraparound, Door	293
Wrench	343-345
Wrench, Faucet Seat	345
Yacht Mop	64
Zip Ties	132
Zone Valve	255
Zone Valve Motor	255
Zum Faucet	187
Zum Flushmeter	219
Zum Flushmeter Repair Part	220

Terms and Conditions



Enterprise Accounts

You are invited to open an Enterprise account. You can apply on-line or have an application faxed to you. Please allow sufficient time to process your application. To place orders during this time, AMRE Supply accepts all major credit cards and can ship to most points in Canada.



Express Accounts

If your requirements do not average \$300.00 or more monthly, we encourage you to open an Express account. This account entitles your firm to all the same discounts and services. Payment is required at time of purchase.

Enterprise Account Payment

Local branches are able to accept payments, but please be aware that late payment fees will not be removed from any overdue account if payment is delayed getting to appropriate location listed below. Customer Service is our highest priority.

Please forward all Account payments to:
AMRE Supply Co Ltd.
201-1259 91st SW
Edmonton, AB
T6X 1E9



We accept:



Please note: ALL returned cheques are subject to a \$25.00 processing fee.

Credit Terms & Policy

Credit terms are net 29# days from date of purchase. Late payments fees will be charged at the rate of 2% per month (26.82% per annum) on all overdue accounts, without exception.

Overdue accounts may be placed on C.O.D., shipments withheld, or credit facilities suspended temporarily without notice until payment is received on the overdue amount.

Late payment fees will appear on statements only. Payments on account will apply firstly to late payment fees and secondly to the outstanding balance.



Special Orders

A special order item is considered to be **any item that is not in stock** at a specific branch.

This includes circumstances when another branch may stock an item when your local one may not. Special orders may require longer delivery times and it is the customers responsibility to inquire on delivery times before ordering. AMRE is not responsible for extra delays from manufacturer and cancellation due to delay will not be accepted.

Special orders are non-returnable. If circumstances are substantial and a return is approved restocking fees and freight charges will apply. Special order items transferred from another branch being returned will be subject to a restocking fee and freight charges. AMRE reserves the right to not accept returns on any non-stock items as they are considered special order. Non Enterprise Accounts: Items specially ordered are subject to a 100% deposit.

Returns

All returns require and RGA (Return Goods Authorization). Please visit website or contact customer care to request an RGA number.



Handling and Freight Policies

Amre Supply uses our own delivery vehicles in certain markets and contracts with established courier's or freight forwarders for markets or areas we do not service with our own fleet. Amre Supply reserves the right to review and revise our handling fees based on market conditions.

Amre Supply reserves the right to select the carrier of our choice if none has been selected. Amre Supply reserves the right to select a carrier of our choice for the transportation of fragile or oversized packages or products.

All handling fees will be invoiced to client at time of shipment. If you have questions or would like to know the costs involved in having your products delivered to your business, any of our sales staff will be happy to quote you on the fees that will be applied.

* All chemicals & dangerous goods are subject to additional environmental handling charge regardless of order value. These handling fees are based on courier fee schedules. Consult with your AMRE Supply representative for applicable charges.

* We are not responsible for damaged products in transit. We recommend insurance be purchased for any fragile items. Some carriers do not offer insurance on glass or light bulbs so please inquire before requesting insurance.

* Any "CUBE" products may be subject to additional handling fees. Watch for these symbols in our catalogue!



Invoices & Packing slips

You will receive both your invoice and packing slip at time of purchase/delivery/receipt of goods. We ask that every effort is made to forward invoice to proper paying authority. We do not forward any additional copies at end of month. A service charge may be applied if additional copies are requested.



You may request invoices to be emailed or faxed to your office at the end of each business day.

Out Of Stock Merchandise

AMRE Supply makes every effort to inventory the items you need when you need them. Unfortunately, shortages do occur. If we are temporarily out of stock, WE WILL BACKORDER ON YOUR REQUEST. Please inform the customer service representative at time of ordering.



Logo's

Brand logo's used in this publication in no way imply that the goods are OEM (Original equipment manufacturer). Most are indeed OEM products but in some cases logo's are only used to signify the brand that the replacement part or product is used on. Please contact an Amre sales representative to verify any OEM manufacturers of parts if needed.



Damage & Short Claims

Claims for shipment shortage or damage must be made within 24 hours of delivery. Obvious shortage/damage should be noted next to your signature on delivery receipt. Please open and inspect your order upon receipt. To process any shortages you will require your delivery tag/process any shortages you will require your delivery tag/waybill number, packing slip number & account number.

**PLEASE NOTE:
AMRE SUPPLY IS NOT RESPONSIBLE FOR DAMAGE BY CARRIER. IF DAMAGE IS NOTED, PLEASE RETAIN ORIGINAL CARTON FOR POSSIBLE CARRIER INSPECTION AND CONTACT CARRIER.**

It is highly advised that insurance should be purchased on any fragile merchandise. Please note that most carriers do not insure glass or light bulbs so please inquire before requesting insurance.

All fragile items must be opened and inspected upon receipt. Failure to inspect any fragile items may result in claim denial. We understand sometimes damage can be concealed but all fragile items must be opened and inspected.

Pricing

AMRE Supply, in an effort to reduce our carbon footprint, has opted to change our annual catalogue to an unpriced reference guide. We encourage all customers to login to your free online AMRE account to see your current wholesale account pricing. Prices, without logging in, reflect AMRE Supply's retail prices and are not reflective of account pricing.

We are not liable for any additional costs incurred with shipping or otherwise in the means of transporting these goods to or from the destination points. For more information, please contact our Customer Care Centre at 1-800-661-9891 or customercare@amresupply.com



WARRANTY

Our warranty with respect to any item sold is limited solely to the warranty of the products manufacturer. Amre makes no other warranty of any kind, expressed or implied. We are not responsible for labor charges or consequential damages of any nature whatsoever. We will not assume any responsibility for improper diagnosis or installation. All warranties are limited to the proper use, application, and installation by a trained individual in the industry, and in all events Amre Supply's liability is limited to the purchase price.

REPLACEMENT WARRANTY

Most manufacturer warranties are Replacement or Repair Part Provided Policies and are not subject to a refund so please inquire regarding the policy of your particular item before taking any steps.

MORE WARRANTY INFORMATION

Please visit the warranty section of our website for complete information including In-Home Warranty, Date coded items, Warranty Claim Parts etc...

AMRE ANSWER GUIDE

Building Maintenance Parts and Supplies

2018-2019 CATALOGUE

everything
you need...

Across Canada . western . central . east



Visit us and
shop online



Setup an account! It's EASY!
Apply online on our website.
www.amresupply.com

Ways to Pay:

Convenient **EXPRESS Account** or our
ENTERPRISE Charge Account.
Other methods of payment:

We
accept:



24 HR.
Order by 4pm for 24-48hr shipping to
almost anywhere in Canada!

www.amresupply.com
1.800.661.9891

Edmonton S
5020 - 75 St.
(780) 461-2929
Fax: 780-465-4271

Saskatoon
411A - 50th St. E.
(306) 955-2673
Fax: 306-955-3992

London
1761 Oxford St. East
(519) 451-2300
Fax: 519-451-3361

**EDMONTON D/T
MegaCenter**
11413-120 St
(780) 426-2673
Fax: 780-784-1222

Surrey
#101, 5433 - 152 Street
(604) 575-9727
Fax: 604-575-5077

**SCARBOROUGH
MegaCenter**
2161 Midland Ave.
(416) 412-7278
Fax: 416-412-7890

**CALGARY
MegaCenter**
#101, 5760 - 9th Street SE
(403) 243-6662
Fax: 403-243-9368

Winnipeg
1370 Sargent Ave.
(204) 775-8409
Fax: 204-786-5718

Windsor
Unit 1, 5900 Rhodes Dr.
(519) 250-0000
Fax: 519-250-8621

**RICHMOND
MegaCenter**
7671 Alderbridge Way
(604) 273-7377
Fax: 604-279-2310

Hamilton
16 Brockley Drive
(905) 560-2673
Fax: 905-560-2405

**MISSISSAUGA
MegaCenter**
Unit 5-4800
Eastgate Parkway
(905) 625-1267

Appliances . Appliance Parts . Communication . Door & Window Hardware
Electrical . Hardware . HVAC . Janitorial . Lighting . Material Handling . Motors .
Paint & Sundries . Plumbing . Safety & Signage . Seasonal . Tools

AMRE SUPPLY
Property Performance Centres

Supporting our Industry Associations



Prices Subject to change without notice. Prices are intended for Amre Supply Account Contractors Only. Amre Supply reserves the right to withhold these prices to non contractor or non account holders. We also reserve the right to change prices or substitute products if product illustrated becomes no longer available.

Print Date June 1, 2018 Full Year Edition

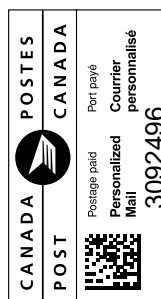

RETURN POSTAGE GUARANTEED
PORT DE RETOUR GARANTI

Amre Supply
11413-120 Street
Edmonton, AB
T5G 2Y3 Canada

ATTENTION:
Resident Manager / Manager /
Purchasing Dept. / Maintenance Dept.