

TEST REPORT

Applicant: Acer India Pvt Ltd.

Address of Applicant: Embassy Heights 6th Floor, No.13, Magrath Road, (Next to Hosmat Hospital), Bangalore, India

Manufacturer/Factory: Acer India Pvt Ltd.

Address of Manufacturer/Factory: Embassy Heights 6th Floor, No.13, Magrath Road, (Next to Hosmat Hospital), Bangalore, India

Equipment Under Test (EUT)

Product Name: Tablet

Model No.: Acer One 10 T9-1212L

Trade Mark: ACER

FCC ID: 2AMY3ONE10T9-1212L

Applicable standards: FCC CFR Title 47 Part 2
FCC CFR Title 47 Part 22
FCC CFR Title 47 Part 27

Date of sample receipt: November 8, 2022

Date of Test: November 8, 2022~ February 10, 2023

Date of report issued: February 10, 2023

Test Result: PASS *

* In the configuration tested, the EUT complied with the standards specified above.

Authorized Signature:



Robinson Luo

Laboratory Manager

This results shown in this test report refer only to the sample(s) tested, this test report cannot be reproduced, except in full, without prior written permission of the company. The report would be invalid without specific stamp of test institute and the signatures of compiler and approver.

2 Version

Version No.	Date	Description
00	2023-2-10	Original

Prepared By:

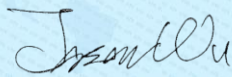

Date:

2023-1-11

Project Engineer

Check By:

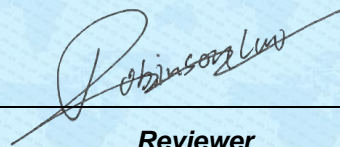

Date:

2023-1-11

Reviewer

3 Contents

	Page
1 COVER PAGE.....	1
2 VERSION.....	2
3 CONTENTS	3
4 TEST SUMMARY	4
5 GENERAL INFORMATION	5
5.1 GENERAL DESCRIPTION OF EUT	5
5.2 RELATED SUBMITTAL(S) / GRANT (S)	7
5.3 TEST METHODOLOGY	7
5.4 TEST FACILITY	7
5.5 TEST LOCATION	7
6 TEST INSTRUMENTS LIST	8
7 SYSTEM TEST CONFIGURATION	10
7.1 TEST MODE	10
7.2 CONFIGURATION OF TESTED SYSTEM.....	10
7.3 CONDUCTED OUTPUT POWER	11
7.4 PEAK-TO-AVERAGE RATIO	22
7.5 OCCUPY BANDWIDTH	24
7.6 MODULATION CHARACTERISTIC	38
7.7 OUT OF BAND EMISSION AT ANTENNA TERMINALS.....	38
7.8 FIELD STRENGTH OF SPURIOUS RADIATION MEASUREMENT	67
7.9 FREQUENCY STABILITY V.S. TEMPERATURE MEASUREMENT.....	70
7.10 FREQUENCY STABILITY V.S. VOLTAGE MEASUREMENT.....	74
8 TEST SETUP PHOTO	76
9 EUT CONSTRUCTIONAL DETAILS	76

4 Test Summary

Test Item	Section in CFR 47	Result
RF Exposure (SAR)	Part 1.1307 Part 2.1093	Pass* (Please refer to SAR Report)
RF Output Power	Part 2.1046 Part 22.913 (a) Part 27.50(a)(h)	Pass
Peak-to-Average Ratio	Part 22.913(d) FCC Part 27.50(a)(h)	Pass
Modulation Characteristics	Part 2.1047	N/A
99% & -26 dB Occupied Bandwidth	Part 2.1049 Part 22.917(b) Part 27.53	Pass
Spurious Emissions at Antenna Terminal	Part 2.1051 Part 22.917 Part 27.53	Pass
Field Strength of Spurious Radiation	Part 2.1053 Part 22.917 Part 27.53	Pass
Out of band emission, Band Edge	Part 22.917 Part 27.53	Pass
Frequency stability vs. temperature	Part 2.1055	Pass
Frequency stability vs. voltage	Part 2.1055	Pass

Remarks:

1. *Pass: The EUT complies with the essential requirements in the standard.*
2. *N/A: Not applicable.*

5 General Information

5.1 General Description of EUT

Product Name:	Tablet
Model No.:	Acer One 10 T9-1212L
Serial No.:	N/A
Hardware Version:	R200
Software Version:	M300Y.WH.211.S0..G.2022120521.C951232A9AD.USERDEBUG
Tested Sample(s) ID:	GTS2023010007-1
Support Networks:	LTE
Support Bands:	Band 5, Band 40, Band 41
TX Frequency:	LTE Band 5: 824-849MHz LTE Band 40: 2305-2315MHz, 2350-2360MHz LTE Band 41: 2555-2655MHz
Modulation type:	OPSK, 16QAM
Antenna type:	Internal Antenna
Antenna gain:	LTE Band 5: 0.8dBi LTE Band 40: 1.4dBi LTE Band 41: 1.6dBi
Power supply:	DC 9V, 2A
Adapter Information	Model: BPS-PN18A Input: AC 100-240V~, 50/60Hz, 800mA (Max) Output: USB-A: 5V 3A, 9V 2A, 12V 1.5A

Test Frequency

Test Mode	Channel Bandwidth	RF Channel		
		Lowest channel	Middle channel	Highest channel
LTE Band 5	1.4M	824.7 MHz	836.5 MHz	848.3 MHz
	3M	825.5 MHz	836.5 MHz	847.5 MHz
	5M	826.5 MHz	836.5 MHz	846.5 MHz
	10M	829.0 MHz	836.5 MHz	844.0 MHz
LTE Band 40 2305-2315MHz	5M	2307.5 MHz	2310 MHz	2312.5 MHz
	10M	/	2310 MHz	/
LTE Band 40 2350-2360MHz	5M	2352.5 MHz	2355 MHz	2357.5 MHz
	10M	/	2355 MHz	/
LTE Band 41	5 MHz	2557.5 MHz	2605 MHz	2652.5 MHz
	10 MHz	2560 MHz	2605 MHz	2650 MHz
	15 MHz	2562.5 MHz	2605 MHz	2647.5 MHz
	20 MHz	2565 MHz	2605 MHz	2645 MHz

5.2 Related Submittal(s) / Grant (s)

This submittal(s) (test report) is filing to comply with Section Part 22/27 of the FCC CFR 47 Rules.

5.3 Test Methodology

Both conducted and radiated testing were performed according to the procedures document on ANSI C63.26:2015 and FCC CFR 47.1046, 2.1047, 2.1049, 2.1051, 2.1053, 2.1055 and 2.1057

5.4 Test Facility

The test facility is recognized, certified, or accredited by the following organizations:

- **FCC —Registration No.: 381383**

Global United Technology Services Co., Ltd., Shenzhen EMC Laboratory has been registered and fully described in a report filed with the (FCC) Federal Communications Commission. The acceptance letter from the FCC is maintained in files. Registration 381383.

- **IC —Registration No.: 9079A**

The 3m Semi-anechoic chamber of Global United Technology Services Co., Ltd. has been registered by Certification and Engineering Bureau of Industry Canada for radio equipment testing with Registration No.: 9079A.

- **NVLAP (LAB CODE:600179-0)**

Global United Technology Services Co., Ltd., is accredited by the National Voluntary Laboratory Accreditation Program (NVLAP). LAB CODE:600179-0

5.5 Test Location

All tests were performed at:

Global United Technology Services Co., Ltd.

Address: No. 123-128, Tower A, Jinyuan Business Building, No.2, Laodong Industrial Zone, Xixiang Road, Baoan District, Shenzhen, Guangdong, China 518102

Tel: 0755-27798480

Fax: 0755-27798960

6 Test Instruments list

Radiated Emission:						
Item	Test Equipment	Manufacturer	Model No.	Inventory No.	Cal.Date (mm-dd-yy)	Cal.Due date (mm-dd-yy)
1	3m Semi- Anechoic Chamber	ZhongYu Electron	9.2(L)*6.2(W)* 6.4(H)	GTS250	July 02, 2020	July 01, 2025
2	Control Room	ZhongYu Electron	6.2(L)*2.5(W)* 2.4(H)	GTS251	N/A	N/A
3	EMI Test Receiver	Rohde & Schwarz	ESU26	GTS203	April 22, 2022	April 21, 2023
4	BiConiLog Antenna	SCHWARZBECK MESS-ELEKTRONIK	VULB9168	GTS640	March 21, 2022	March 20, 2023
5	Double -ridged waveguide horn	SCHWARZBECK MESS-ELEKTRONIK	BBHA 9120 D	GTS208	June 12, 2022	June 11, 2023
6	Horn Antenna	ETS-LINDGREN	3160	GTS217	June 23, 2022	June 22, 2023
7	EMI Test Software	AUDIX	E3	N/A	N/A	N/A
8	Coaxial Cable	GTS	N/A	GTS213	April 22, 2022	April 21, 2023
9	Coaxial Cable	GTS	N/A	GTS211	April 22, 2022	April 21, 2023
10	Coaxial cable	GTS	N/A	GTS210	April 22, 2022	April 21, 2023
11	Coaxial Cable	GTS	N/A	GTS212	April 22, 2022	April 21, 2023
12	Amplifier(100kHz-3GHz)	HP	8347A	GTS204	April 22, 2022	April 21, 2023
13	Amplifier (18-26GHz)	Rohde & Schwarz	AFS33-18002 650-30-8P-44	GTS218	June 23, 2022	June 22, 2023
14	Band filter	Amindeon	82346	GTS219	June 23, 2022	June 22, 2023
15	Power Meter	Anritsu	ML2495A	GTS540	June 23, 2022	June 22, 2023
16	Power Sensor	Anritsu	MA2411B	GTS541	June 23, 2022	June 22, 2023
17	Wideband Radio Communication Tester	Rohde & Schwarz	CMW500	GTS575	April 22, 2022	April 21, 2023
18	Splitter	Agilent	11636B	GTS237	June 23, 2022	June 22, 2023
19	Loop Antenna	ZHINAN	ZN30900A	GTS534	Nov. 29, 2022	Nov. 28, 2023
20	Broadband Preamplifier	SCHWARZBECK	BBV9718	GTS535	April 22, 2022	April 21, 2023
21	Breitband hornantenna	SCHWARZBECK	BBHA 9170	GTS579	Oct. 16, 2022	Oct. 15, 2023
22	Amplifier	TDK	PA-02-02	GTS574	Oct. 16, 2022	Oct. 15, 2023
23	Amplifier	TDK	PA-02-03	GTS576	Oct. 16, 2022	Oct. 15, 2023
24	PSA Series Spectrum Analyzer	Rohde & Schwarz	FSP	GTS578	June 23, 2022	June 22, 2023
25	Amplifier(1GHz-26.5GHz)	HP	8449B	GTS601	April 22, 2022	April 21, 2023

RF Conducted Test:						
Item	Test Equipment	Manufacturer	Model No.	Serial No.	Cal.Date (mm-dd-yy)	Cal.Due date (mm-dd-yy)
1	MXA Signal Analyzer	Agilent	N9020A	GTS566	April 22, 2022	April 21, 2023
2	EMI Test Receiver	R&S	ESCI 7	GTS552	April 22, 2022	April 21, 2023
3	Spectrum Analyzer	Agilent	E4440A	GTS536	April 22, 2022	April 21, 2023
4	MXG vector Signal Generator	Agilent	N5182A	GTS567	April 22, 2022	April 21, 2023
5	ESG Analog Signal Generator	Agilent	E4428C	GTS568	April 22, 2022	April 21, 2023
6	USB RF Power Sensor	DARE	RPR3006W	GTS569	April 22, 2022	April 21, 2023
7	RF Switch Box	Shongyi	RFSW3003328	GTS571	April 22, 2022	April 21, 2023
8	Programmable Constant Temp & Humi Test Chamber	WEWON	WHTH-150L-40-880	GTS572	April 22, 2022	April 21, 2023

General used equipment:						
Item	Test Equipment	Manufacturer	Model No.	Inventory No.	Cal.Date (mm-dd-yy)	Cal.Due date (mm-dd-yy)
1	Humidity/ Temperature Indicator	KTJ	TA328	GTS243	April 25, 2022	April 24, 2023
2	Barometer	KUMAO	SF132	GTS647	July 26, 2022	July 25, 2023

7 System test configuration

7.1 Test mode

During all testing, EUT is in link mode with base station emulator at maximum power level. The spurious emission measurements were carried out in semi-anechoic chamber with 3-meter test range, and EUT is rotated on three test planes to find out the worst emission.

Test modes		
Band	Radiated	Conducted
LTE Band 5	■ QPSK and 16QAM link	■ QPSK and 16QAM link
LTE Band 40 Lower	■ QPSK and 16QAM link	■ QPSK and 16QAM link
LTE Band 40 Upper	■ QPSK and 16QAM link	■ QPSK and 16QAM link
LTE Band 41	■ QPSK and 16QAM link	■ QPSK and 16QAM link

7.2 Configuration of Tested System

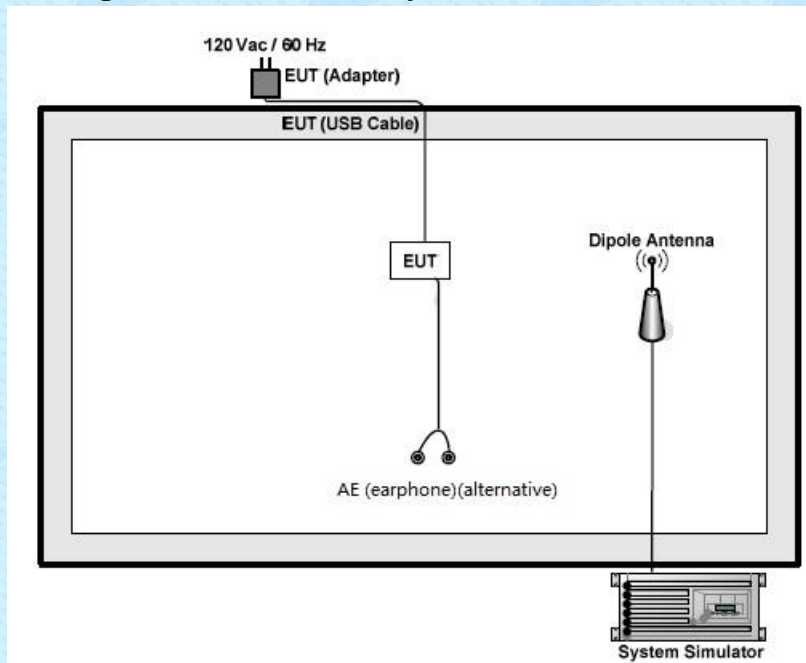

7.3 Conducted Output Power

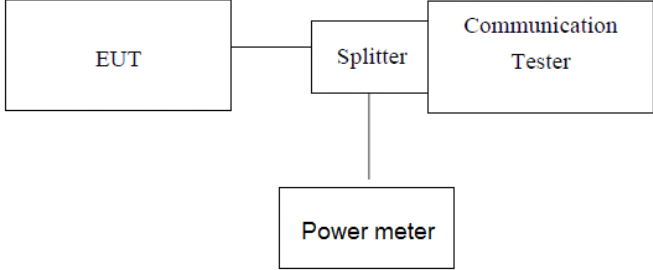
Test Requirement:	FCC part 22.913, Part 27.50
Test Method:	FCC part 2.1046
Limit:	LTE Band 5: 7W LTE Band 40: 250mW/5MHz LTE Band 41: 2W
Test setup:	 <p style="text-align: center;"><i>Note: Measurement setup for testing on Antenna connector</i></p>
Test Instruments:	Refer to section 6.0 for details
Test mode:	Refer to section 6.1 for details
Test results:	Pass

Measurement Data:

LTE Band 5

Bandwidth (MHz)	Modulation	RB size/RB Offset	Conducted Average Output Power (dBm)			ERP (dBm)		
			Low	Middle	High	Low	Middle	High
1.4	QPSK	RB1#0	20.97	20.42	20.92	19.12	18.57	19.07
		RB1#2	21.08	20.50	21.05	19.23	18.65	19.2
		RB1#5	20.89	20.44	20.96	19.04	18.59	19.11
		RB3#0	21.12	20.32	20.80	19.27	18.47	18.95
		RB3#1	20.95	20.51	21.03	19.1	18.66	19.18
		RB3#2	21.11	20.39	20.88	19.26	18.54	19.03
		RB6#0	20.90	20.48	20.96	19.05	18.63	19.11
	16QAM	RB1#0	19.83	19.48	20.07	17.98	17.63	18.22
		RB1#2	19.92	19.50	20.25	18.07	17.65	18.4
		RB1#5	19.97	19.51	20.08	18.12	17.66	18.23
		RB3#0	19.78	19.31	20.01	17.93	17.46	18.16
		RB3#1	20.01	19.62	20.07	18.16	17.77	18.22
		RB3#2	19.74	19.39	20.03	17.89	17.54	18.18
		RB6#0	20.02	19.59	20.25	18.17	17.74	18.4
3	QPSK	RB1#0	21.05	20.41	20.06	19.2	18.56	18.21
		RB1#7	21.17	20.60	20.17	19.32	18.75	18.32
		RB1#14	21.11	20.41	20.15	19.26	18.56	18.3
		RB8#0	20.94	20.29	19.97	19.09	18.44	18.12
		RB8#4	21.24	20.48	20.14	19.39	18.63	18.29
		RB8#17	21.01	20.32	20.04	19.16	18.47	18.19
		RB15#0	21.08	20.50	20.07	19.23	18.65	18.22
	16QAM	RB1#0	20.04	19.20	19.12	18.19	17.35	17.27
		RB1#7	20.04	19.32	19.28	18.19	17.47	17.43
		RB1#14	20.06	19.34	19.17	18.21	17.49	17.32
		RB8#0	19.92	19.04	18.93	18.07	17.19	17.08
		RB8#4	20.19	19.38	19.16	18.34	17.53	17.31
		RB8#17	19.90	19.02	18.93	18.05	17.17	17.08
		RB15#0	20.08	19.29	19.14	18.23	17.44	17.29

Bandwidth (MHz)	Modulation	RB size/RB Offset	Conducted Average Output Power (dBm)			ERP (dBm)		
			Low	Middle	High	Low	Middle	High
5	QPSK	1RB#0	21.21	21.10	20.55	19.36	19.25	18.7
		1RB#12	21.28	21.18	20.56	19.43	19.33	18.71
		1RB#24	21.35	21.26	20.61	19.5	19.41	18.76
		12RB#0	21.16	20.91	20.41	19.31	19.06	18.56
		12RB#6	21.31	21.29	20.68	19.46	19.44	18.83
		12RB#13	21.16	20.96	20.41	19.31	19.11	18.56
		25RB#0	21.24	21.12	20.55	19.39	19.27	18.7
	16QAM	1RB#0	20.25	20.21	19.54	18.4	18.36	17.69
		1RB#12	20.42	20.25	19.73	18.57	18.4	17.88
		1RB#24	20.37	20.22	19.71	18.52	18.37	17.86
		12RB#0	20.20	20.21	19.43	18.35	18.36	17.58
		12RB#6	20.29	20.22	19.56	18.44	18.37	17.71
		12RB#13	20.15	20.05	19.41	18.3	18.2	17.56
		25RB#0	20.44	20.25	19.74	18.59	18.4	17.89
10	QPSK	1RB#0	21.15	20.35	20.62	19.3	18.5	18.77
		1RB#24	21.18	20.39	20.76	19.33	18.54	18.91
		1RB#49	21.15	20.40	20.77	19.3	18.55	18.92
		25RB#0	21.15	20.18	20.53	19.3	18.33	18.68
		25RB#12	21.30	20.47	20.80	19.45	18.62	18.95
		25RB#25	21.04	20.29	20.54	19.19	18.44	18.69
		50RB#0	21.23	20.47	20.68	19.38	18.62	18.83
	16QAM	1RB#0	20.18	19.37	19.70	18.33	17.52	17.85
		1RB#24	20.31	19.45	19.76	18.46	17.6	17.91
		1RB#49	20.35	19.48	19.80	18.5	17.63	17.95
		25RB#0	20.02	19.22	19.54	18.17	17.37	17.69
		25RB#12	20.26	19.49	19.73	18.41	17.64	17.88
		25RB#25	20.10	19.34	19.57	18.25	17.49	17.72
		50RB#0	20.19	19.45	19.74	18.34	17.6	17.89

Note: ERP (dBm) = Conducted Power(dBm) + Antenna Gain(dBd) - Cable Loss(dB)
 For Band 5: Antenna Gain =0.8dBi =-1.35dBd (0dBd=2.15dBi)
 Cable Loss=0.5dB (provided by the applicant)
 Limit: EIRP<38.45dBm

LTE Band 40 Lower

Bandwidth (MHz)	Modulation	RB size/RB Offset	Conducted Average Output Power (dBm)			EIRP (dBm)		
			Low	Middle	High	Low	Middle	High
5	QPSK	1RB#0	17.09	16.09	16.50	17.99	16.99	17.4
		1RB#12	17.21	16.15	16.60	18.11	17.05	17.5
		1RB#24	16.90	16.17	16.51	17.8	17.07	17.41
		12RB#0	17.09	15.94	16.42	17.99	16.84	17.32
		12RB#6	16.93	16.25	16.66	17.83	17.15	17.56
		12RB#13	17.18	15.90	16.40	18.08	16.8	17.3
		25RB#0	17.03	16.12	16.69	17.93	17.02	17.59
	16QAM	1RB#0	16.12	15.94	15.42	17.02	16.84	16.32
		1RB#12	16.06	15.87	15.43	16.96	16.77	16.33
		1RB#24	15.93	15.98	15.46	16.83	16.88	16.36
		12RB#0	16.01	15.94	15.29	16.91	16.84	16.19
		12RB#6	16.05	15.89	15.53	16.95	16.79	16.43
		12RB#13	16.09	15.95	15.40	16.99	16.85	16.3
		25RB#0	15.99	15.94	15.46	16.89	16.84	16.36
10	QPSK	1RB#0		15.94			16.84	
		1RB#24		16.11			17.01	
		1RB#49		16.00			16.9	
		25RB#0		15.88			16.78	
		25RB#12		16.05			16.95	
		25RB#25		15.91			16.81	
		50RB#0		16.01			16.91	
	16QAM	1RB#0		15.42			16.32	
		1RB#24		15.54			16.44	
		1RB#49		15.50			16.4	
		25RB#0		15.39			16.29	
		25RB#12		15.58			16.48	
		25RB#25		15.41			16.31	
		50RB#0		15.59			16.49	

Note: EIRP (dBm) = Conducted Power(dBm) + Antenna Gain(dBi) - Cable loss(dB)

For Band 40: Antenna Gain = 1.4dBi

For 1000-3000MHz, Cable Loss=0.5dB (provided by the applicant)

Limit: EIRP<24dBm/5MHz

For 5MHz mode, the channel power is equal to the test result in dBm/5MHz

For 10MHz mode, the channel power is sum of 10MHz bandwidth, the result is less than 24dBm, so in any 5MHz bandwidth, it will not exceed the limit

Duty cycle

Modulation	Bandwidth(MHz)	Ton(ms)	Ton+Toff(ms)	Duty cycle (%)	Limit (%)
QPSK	5	1.06	5	21.2	38
	10	1.04	5	20.8	38
16QAM	5	1.04	5	20.8	38
	10	1.06	5	21.2	38

5MHz, QPSK

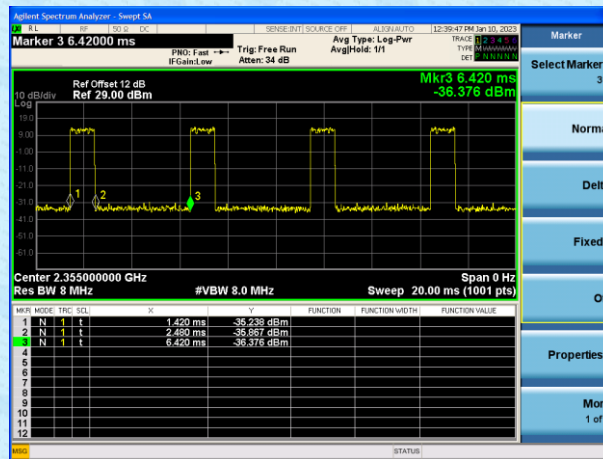

5MHz, 16QAM

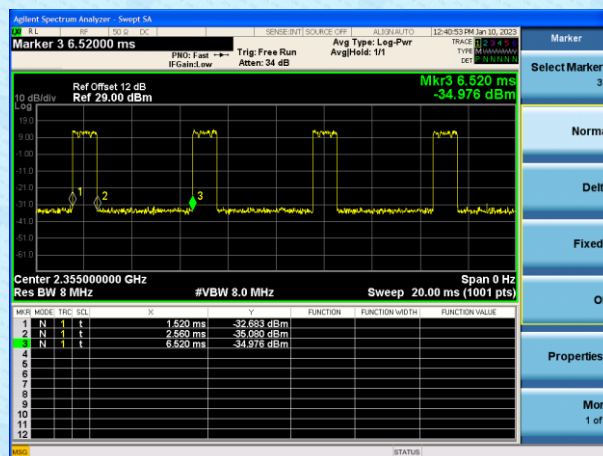

10MHz, QPSK

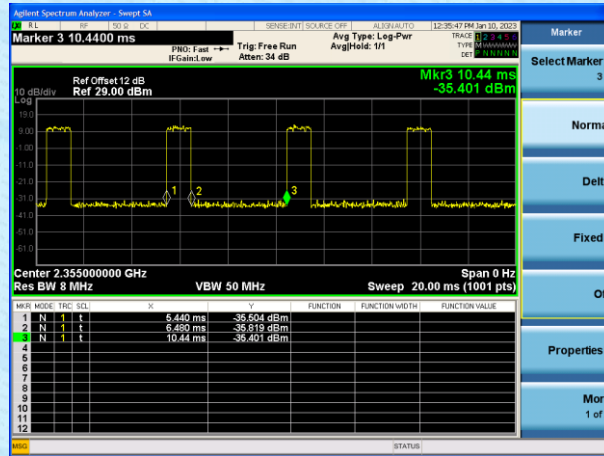

10MHz, 16QAM

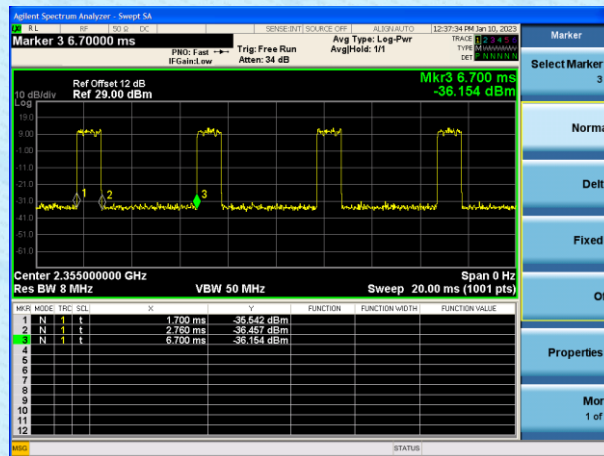

LTE Band 40 Upper

Bandwidth (MHz)	Modulation	RB size/RB Offset	Conducted Average Output Power (dBm)			EIRP (dBm)		
			Low	Middle	High	Low	Middle	High
5	QPSK	1RB#0	15.93	16.17	15.78	16.83	17.07	16.68
		1RB#12	15.89	16.18	15.92	16.79	17.08	16.82
		1RB#24	15.85	16.21	15.79	16.75	17.11	16.69
		12RB#0	15.83	16.12	15.62	16.73	17.02	16.52
		12RB#6	15.83	16.21	15.96	16.73	17.11	16.86
		12RB#13	16.12	16.02	15.59	17.02	16.92	16.49
		25RB#0	15.89	16.30	15.86	16.79	17.2	16.76
	16QAM	1RB#0	14.79	14.48	14.93	15.69	15.38	15.83
		1RB#12	14.93	14.58	14.95	15.83	15.48	15.85
		1RB#24	14.87	14.50	15.08	15.77	15.4	15.98
		12RB#0	14.60	14.45	14.87	15.5	15.35	15.77
		12RB#6	14.81	14.65	15.11	15.71	15.55	16.01
		12RB#13	14.71	14.29	14.74	15.61	15.19	15.64
		25RB#0	14.94	14.50	15.04	15.84	15.4	15.94
10	QPSK	1RB#0		15.58			16.48	
		1RB#24		15.70			16.6	
		1RB#49		15.67			16.57	
		25RB#0		15.51			16.41	
		25RB#12		15.59			16.49	
		25RB#25		15.54			16.44	
		50RB#0		15.71			16.61	
	16QAM	1RB#0		14.64			15.54	
		1RB#24		14.75			15.65	
		1RB#49		14.79			15.69	
		25RB#0		14.63			15.53	
		25RB#12		14.69			15.59	
		25RB#25		14.62			15.52	
		50RB#0		14.65			15.55	

Note: EIRP (dBm) = Conducted Power(dBm) + Antenna Gain(dBi) - Cable loss(dB)

For Band 40: Antenna Gain = 1.4dBi

For 1000-3000MHz, Cable Loss=0.5dB (provided by the applicant)

Limit: EIRP<24dBm/5MHz

For 5MHz mode, the channel power is equal to the test result in dBm/5MHz

For 10MHz mode, the channel power is sum of 10MHz bandwidth, the result is less than 24dBm, so in any 5MHz bandwidth, it will not exceed the limit

Duty cycle

Modulation	Bandwidth(MHz)	Ton(ms)	Ton+Toff(ms)	Duty cycle (%)	Limit (%)
QPSK	5	1.04	5	20.8	38
	10	1.04	5	20.8	38
16QAM	5	1.06	5	21.2	38
	10	1.06	5	21.2	38

5MHz, QPSK

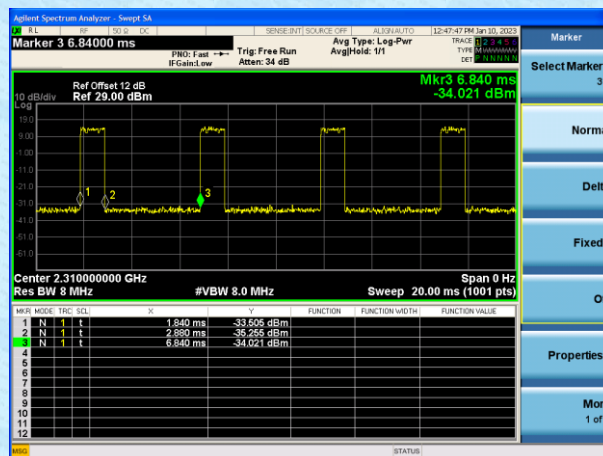

5MHz, 16QAM

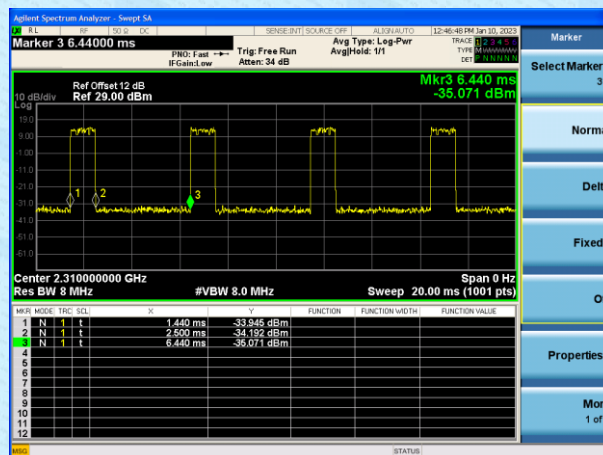

10MHz, QPSK

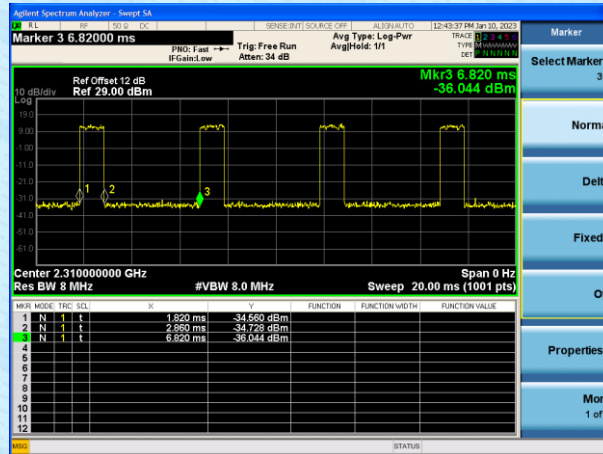

10MHz, 16QAM

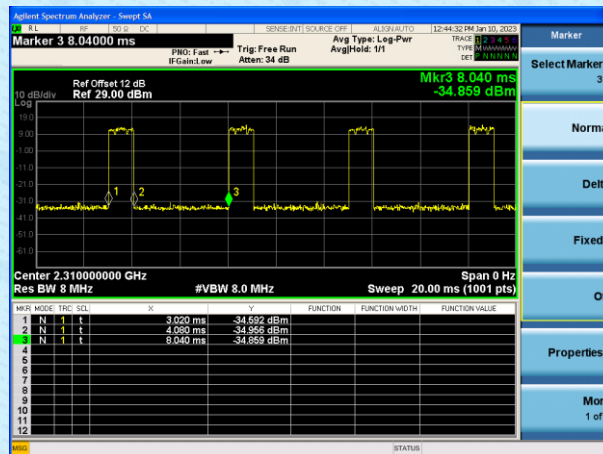

LTE Band 41

Bandwidth (MHz)	Modulation	RB size/RB Offset	Conducted Average Output Power (dBm)			EIRP (dBm)		
			Low	Middle	High	Low	Middle	High
5	QPSK	1RB#0	14.25	13.86	14.48	15.35	14.96	15.58
		1RB#12	14.38	13.88	14.54	15.48	14.98	15.64
		1RB#24	14.20	13.98	14.50	15.3	15.08	15.6
		12RB#0	14.15	13.77	14.34	15.25	14.87	15.44
		12RB#6	14.19	14.02	14.53	15.29	15.12	15.63
		12RB#13	14.27	13.70	14.39	15.37	14.8	15.49
		25RB#0	14.11	13.96	14.56	15.21	15.06	15.66
	16QAM	1RB#0	13.48	13.04	13.60	14.58	14.14	14.7
		1RB#12	13.66	13.08	13.77	14.76	14.18	14.87
		1RB#24	13.49	13.11	13.73	14.59	14.21	14.83
		12RB#0	13.41	12.94	13.59	14.51	14.04	14.69
		12RB#6	13.50	13.16	13.66	14.6	14.26	14.76
		12RB#13	13.42	12.90	13.42	14.52	14	14.52
		25RB#0	13.61	13.10	13.68	14.71	14.2	14.78
10	QPSK	1RB#0	14.62	14.60	14.41	15.72	15.7	15.51
		1RB#24	14.79	14.74	14.43	15.89	15.84	15.53
		1RB#49	14.80	14.66	14.55	15.9	15.76	15.65
		25RB#0	14.52	14.58	14.36	15.62	15.68	15.46
		25RB#12	14.64	14.63	14.43	15.74	15.73	15.53
		25RB#25	14.47	14.43	14.32	15.57	15.53	15.42
		50RB#0	14.79	14.70	14.53	15.89	15.8	15.63
	16QAM	1RB#0	13.50	13.63	13.48	14.6	14.73	14.58
		1RB#24	13.68	13.68	13.63	14.78	14.78	14.73
		1RB#49	13.69	13.75	13.52	14.79	14.85	14.62
		25RB#0	13.46	13.53	13.32	14.56	14.63	14.42
		25RB#12	13.67	13.79	13.60	14.77	14.89	14.7
		25RB#25	13.40	13.53	13.39	14.5	14.63	14.49
		50RB#0	13.61	13.73	13.51	14.71	14.83	14.61

Bandwidth (MHz)	Modulation	RB size/RB Offset	Conducted Average Output Power (dBm)			EIRP (dBm)		
			Low	Middle	High	Low	Middle	High
15	QPSK	1RB#0	14.22	14.69	14.81	15.32	15.79	15.91
		1RB#38	14.35	14.87	14.93	15.45	15.97	16.03
		1RB#74	14.38	14.78	14.84	15.48	15.88	15.94
		38RB#0	14.16	14.49	14.69	15.26	15.59	15.79
		38RB#18	14.27	14.80	14.93	15.37	15.9	16.03
		38RB#37	14.16	14.60	14.63	15.26	15.7	15.73
		75RB#0	14.30	14.86	14.97	15.4	15.96	16.07
	16QAM	1RB#0	13.10	13.67	13.22	14.2	14.77	14.32
		1RB#38	13.24	13.78	13.24	14.34	14.88	14.34
		1RB#74	13.26	13.77	13.28	14.36	14.87	14.38
		38RB#0	13.02	13.54	13.07	14.12	14.64	14.17
		38RB#18	13.27	13.85	13.35	14.37	14.95	14.45
		38RB#37	12.91	13.48	13.11	14.01	14.58	14.21
		75RB#0	13.22	13.82	13.41	14.32	14.92	14.51
20	QPSK	1RB#0	13.86	13.91	14.23	14.96	15.01	15.33
		1RB#49	13.90	14.01	14.32	15	15.11	15.42
		1RB#99	14.01	14.10	14.27	15.11	15.2	15.37
		50RB#0	13.69	13.85	14.19	14.79	14.95	15.29
		50RB#25	14.05	14.00	14.38	15.15	15.1	15.48
		50RB#50	13.76	13.91	14.03	14.86	15.01	15.13
		100RB#0	14.04	14.09	14.29	15.14	15.19	15.39
	16QAM	1RB#0	12.87	13.00	13.26	13.97	14.1	14.36
		1RB#49	12.97	13.07	13.40	14.07	14.17	14.5
		1RB#99	12.95	13.11	13.43	14.05	14.21	14.53
		50RB#0	12.81	12.95	13.09	13.91	14.05	14.19
		50RB#25	12.87	13.16	13.33	13.97	14.26	14.43
		50RB#50	12.74	12.82	13.24	13.84	13.92	14.34
		100RB#0	13.00	13.02	13.26	14.1	14.12	14.36

Note: EIRP (dBm) = Conducted Power(dBm) + Antenna Gain(dBi) - Cable loss(dB)
 For Band 41: Antenna Gain = 1.6dBi
 For 1000-3000MHz, Cable Loss=0.5dB (provided by the applicant)
 Limit: EIRP<33dBm

7.4 Peak-to-Average Ratio

Test Requirement:	FCC part 22.913(d) & FCC Part 27.50
Test Method:	FCC part 2.1046
Limit:	13db
Test setup:	<pre> graph LR CC[Control Computer] --> EUT[EUT] PS[Power Supply] --> EUT EUT --> PD[Power Divider] PD --> WC[Wireless Communication] PD --> SA[Spectrum Analyzer] </pre>
Test Instruments:	Refer to section 6.0 for details
Test mode:	Refer to section 7.1 for details
Test results:	Pass

Remark: All mode bandwidths are tested, showing only the worst case test data.

Measurement data:

LTE Band 5

10MHz bandwidth

Modulation	Low channel (dB)	Middle channel (dB)	High channel (dB)	PAR Limit (dB)
QPSK (1RB Size)	5.33	5.84	5.94	13
QPSK (50RB Size)	4.63	5.85	6.37	13
16QAM (1RB Size)	5.02	6.59	4.36	13
16QAM (50RB Size)	5.81	4.26	5.65	13

LTE Band 40 Lower

10MHz bandwidth

Modulation	Middle channel (dB)	PAR Limit (dB)
QPSK (1RB Size)	5.77	13
QPSK (100RB Size)	6.02	13
16QAM (1RB Size)	3.22	13
16QAM (100RB Size)	5.45	13

LTE Band 40 Upper

10MHz bandwidth

Modulation	Middle channel (dB)	PAR Limit (dB)
QPSK (1RB Size)	6.88	13
QPSK (100RB Size)	4.68	13
16QAM (1RB Size)	5.91	13
16QAM (100RB Size)	4.53	13

LTE Band 41

20MHz bandwidth

Modulation	Low channel (dB)	Middle channel (dB)	High channel (dB)	PAR Limit (dB)
QPSK (1RB Size)	4.47	5.87	4.34	13
QPSK (100RB Size)	5.56	4.40	5.85	13
16QAM (1RB Size)	5.13	5.94	4.64	13
16QAM (100RB Size)	6.57	5.90	5.38	13

7.5 Occupy Bandwidth

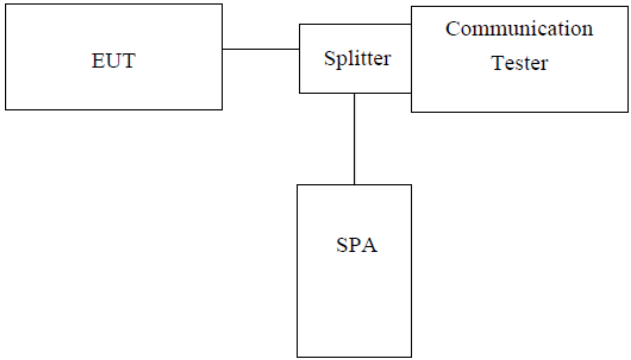
Test Requirement:	FCC Part 27.53; part 22.917
Test Method:	FCC part2.1049
Test setup:	 <p><i>Note: Measurement setup for testing on Antenna connector</i></p>
Test Procedure:	<ol style="list-style-type: none"> 1. The EUT's output RF connector was connected with a short cable to the spectrum analyzer 2. RBW was set to about 1% of emission BW, VBW= 3 times RBW. 3. -26dBc display line was placed on the screen (or 99% bandwidth), the occupied bandwidth is the delta frequency between the two points where the display line intersects the signal trace.
Test Instruments:	Refer to section 6.0 for details
Test mode:	Refer to section 6.1 for details
Test results:	Pass

Measurement Data:

LTE Band 5

Bandwidth	Mode	Low Channel		Middle Channel		High Channel	
		99% OBW (MHz)	-26dB OBW (MHz)	99% OBW (MHz)	-26dB OBW (MHz)	99% OBW (MHz)	-26dB OBW (MHz)
1.4M	QPSK	1.12	2.03	1.10	1.81	1.11	1.87
	16QAM	1.10	1.46	1.11	1.35	1.09	1.32
3M	QPSK	2.68	3.31	2.68	2.88	2.68	3.18
	16QAM	2.68	2.89	2.69	3.44	2.68	2.90
5M	QPSK	4.50	4.95	4.54	5.27	4.56	8.37
	16QAM	4.51	5.77	4.52	5.06	4.51	4.95
10M	QPSK	8.92	9.53	8.95	9.64	8.94	9.57
	16QAM	8.92	9.51	8.96	9.60	8.92	9.48

LTE Band 40 Lower

Bandwidth	Mode	Low Channel		Middle Channel		High Channel	
		99% OBW (MHz)	-26dB OBW (MHz)	99% OBW (MHz)	-26dB OBW (MHz)	99% OBW (MHz)	-26dB OBW (MHz)
5M	QPSK	4.51	5.20	4.52	5.03	4.53	5.11
	16QAM	4.51	5.29	4.49	5.09	4.51	5.11
10M	QPSK	---	---	8.93	9.65	---	---
	16QAM	---	---	8.95	9.86	---	---

LTE Band 40 Upper

Bandwidth	Mode	Low Channel		Middle Channel		High Channel	
		99% OBW (MHz)	-26dB OBW (MHz)	99% OBW (MHz)	-26dB OBW (MHz)	99% OBW (MHz)	-26dB OBW (MHz)
5M	QPSK	4.50	5.04	4.52	5.05	4.52	5.13
	16QAM	4.51	5.19	4.52	5.21	4.50	5.31
10M	QPSK	---	---	8.95	10.33	---	---
	16QAM	---	---	8.95	9.87	---	---

LTE Band 41

Bandwidth	Mode	Low Channel		Middle Channel		High Channel	
		99% OBW (MHz)	-26dB OBW (MHz)	99% OBW (MHz)	-26dB OBW (MHz)	99% OBW (MHz)	-26dB OBW (MHz)
5M	QPSK	4.50	4.86	4.50	5.15	4.49	5.04
	16QAM	4.51	4.92	4.50	4.97	4.49	5.27
10M	QPSK	8.94	9.68	8.93	9.65	8.93	9.65
	16QAM	8.95	9.54	8.94	9.89	8.93	9.48
15M	QPSK	13.48	14.80	13.46	15.02	13.48	15.69
	16QAM	13.48	14.61	13.50	15.45	13.47	15.82
20M	QPSK	17.90	18.98	17.10	19.88	17.84	19.13
	16QAM	17.87	19.42	17.88	19.06	17.86	19.14

Remark: "---" is not applicable

LTE Band 5

1.4M Bandwidth QPSK	1.4M Bandwidth 16QAM
----------------------------	-----------------------------



Low Channel

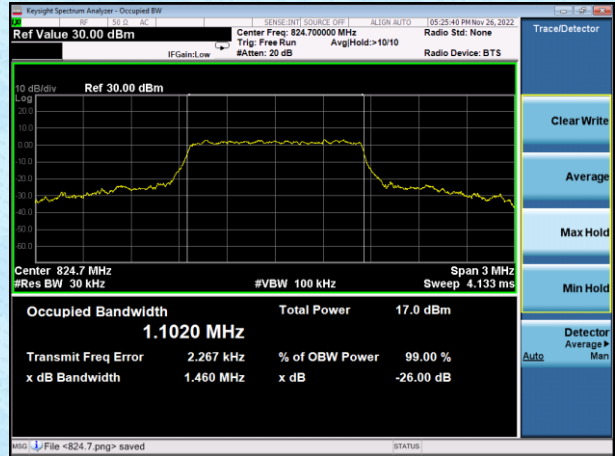

Low Channel

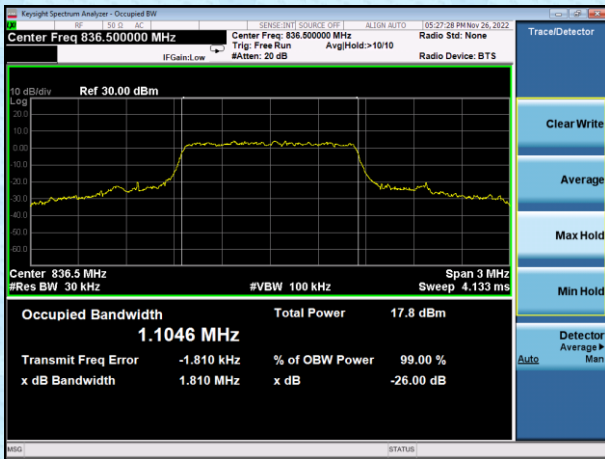

Middle Channel

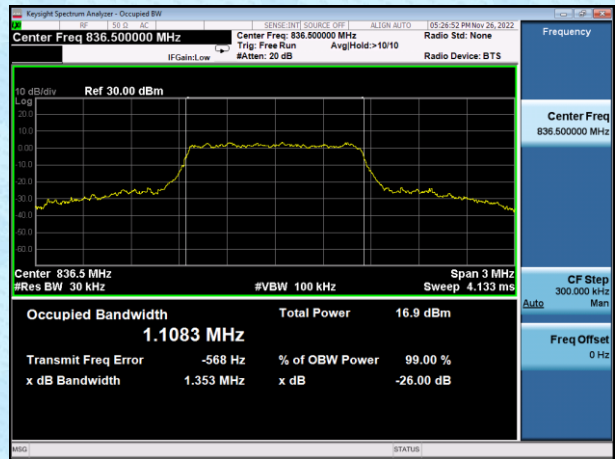

Middle Channel

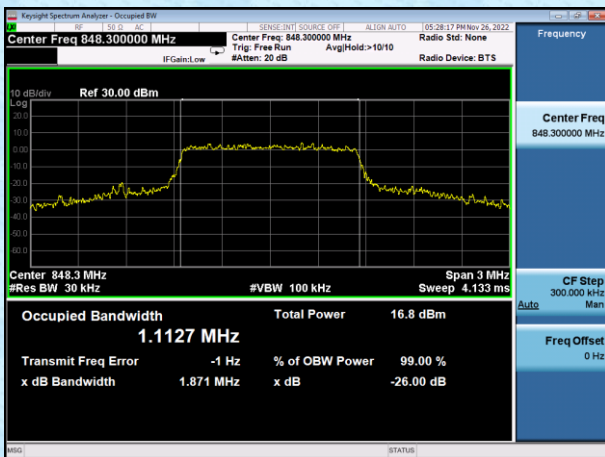

High Channel

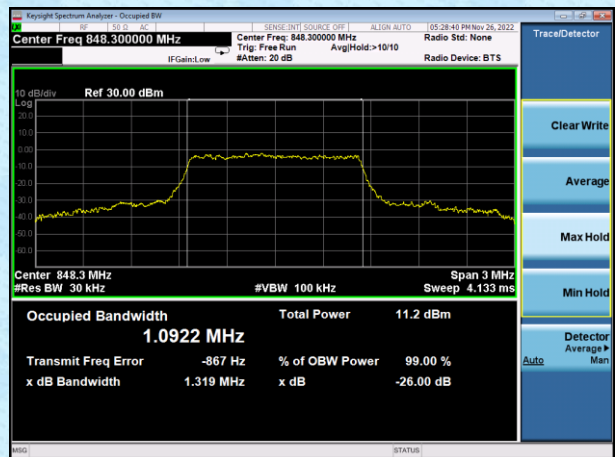

High Channel

3M Bandwidth QPSK

3M Bandwidth 16QAM

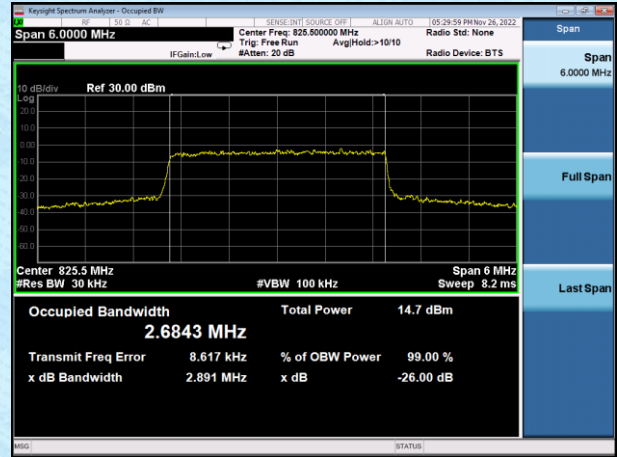
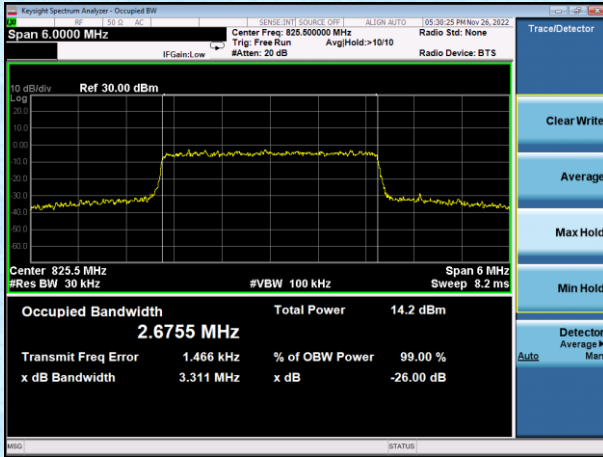

Low Channel

Low Channel

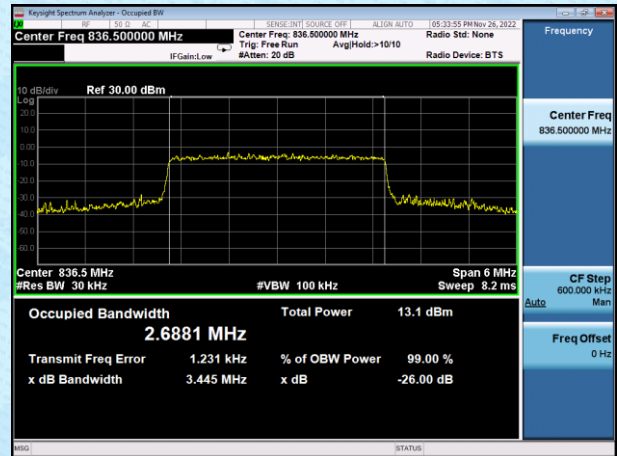

Middle Channel

Middle Channel

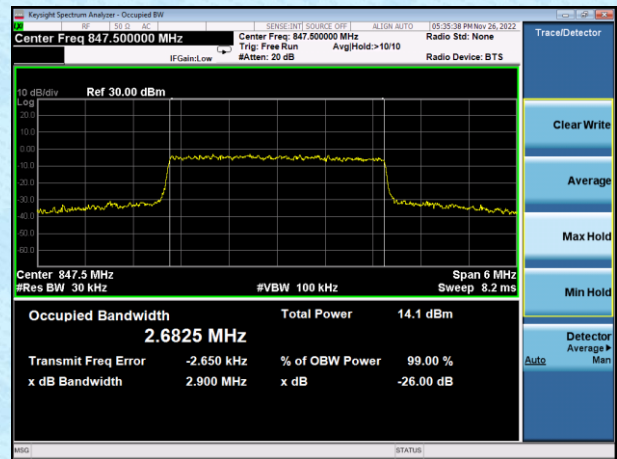
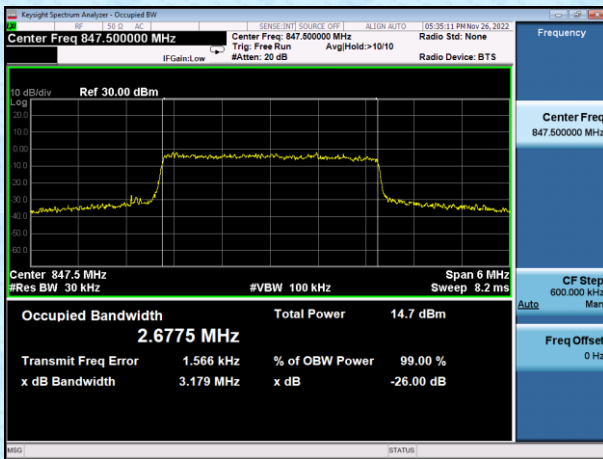

High Channel

High Channel

5M Bandwidth QPSK

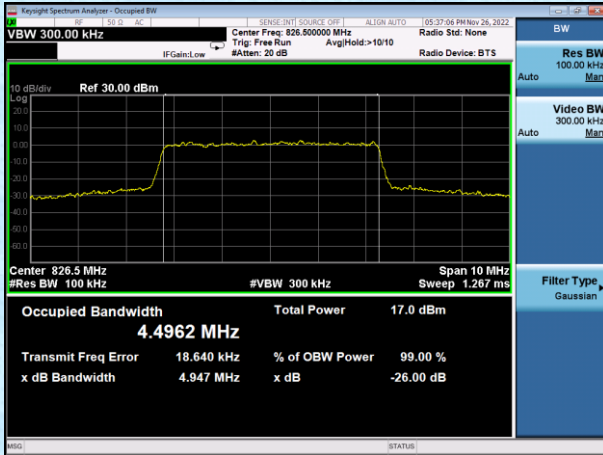

Low Channel

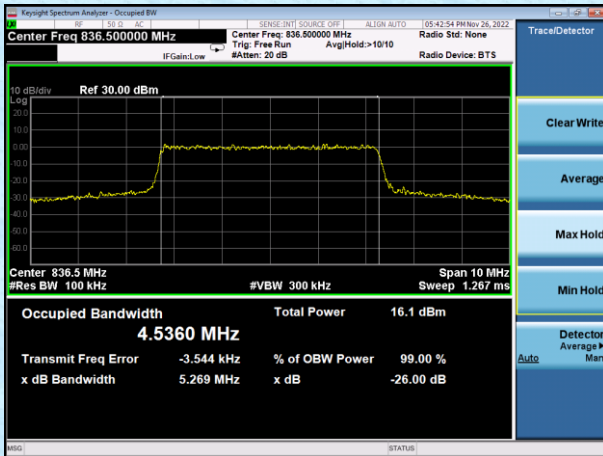

Middle Channel

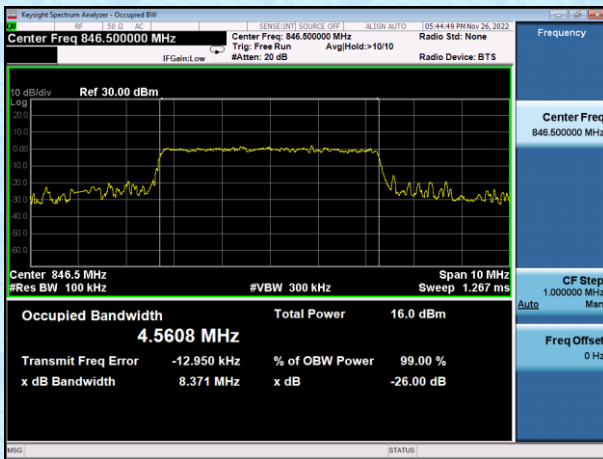

High Channel

5M Bandwidth 16QAM

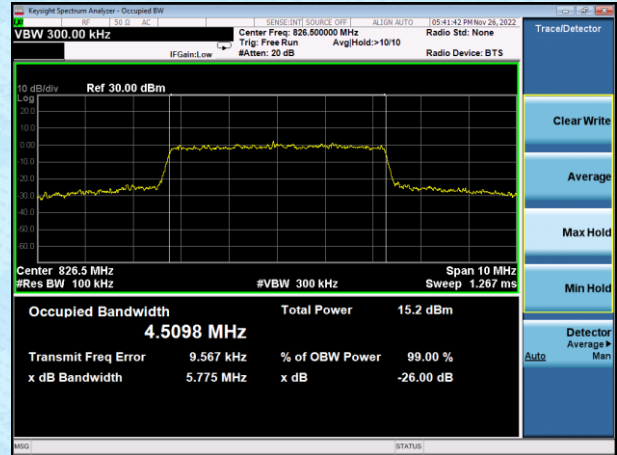

Low Channel

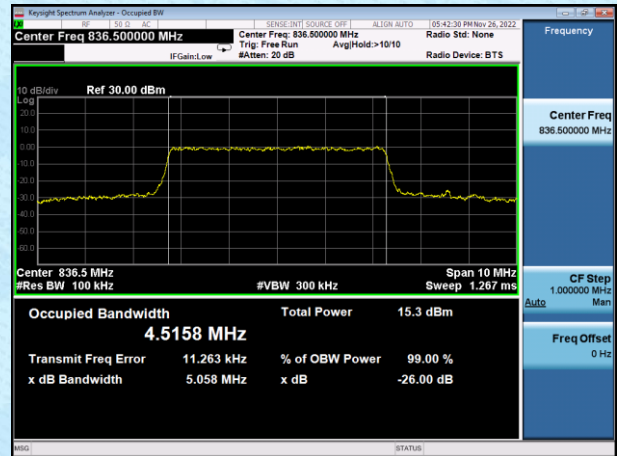

Middle Channel



High Channel

10M Bandwidth QPSK	10M Bandwidth 16QAM
---------------------------	----------------------------

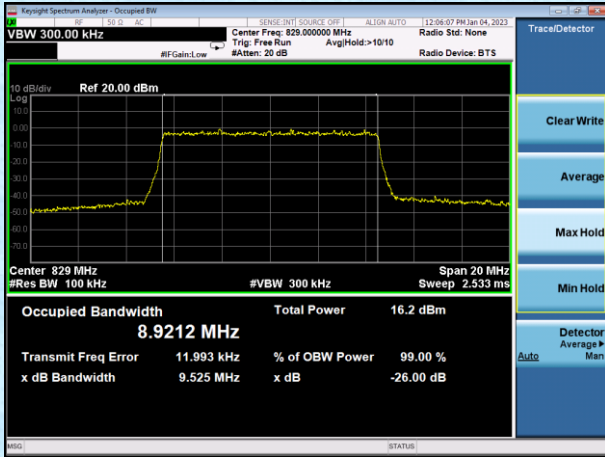

Low Channel

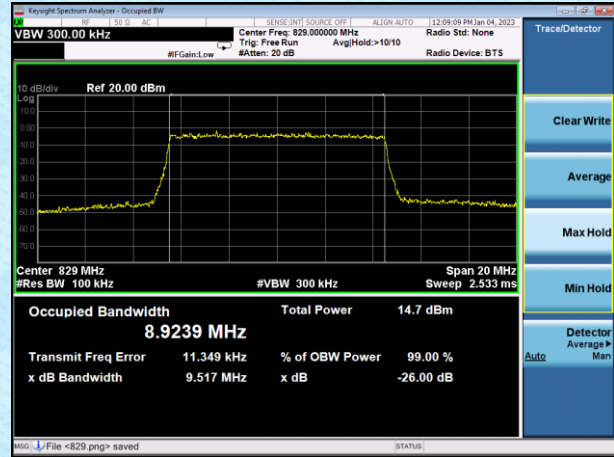

Low Channel



Middle Channel



Middle Channel

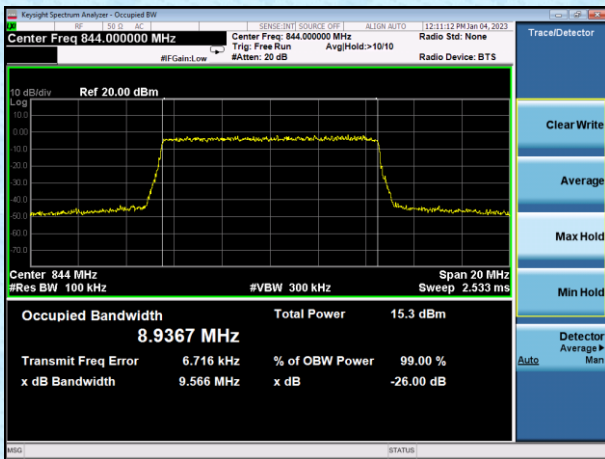

High Channel



High Channel

LTE Band 40 Lower

5M Bandwidth QPSK	5M Bandwidth 16QAM
--------------------------	---------------------------

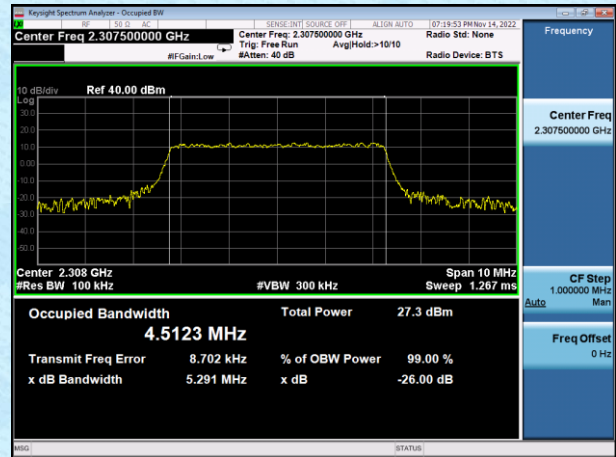
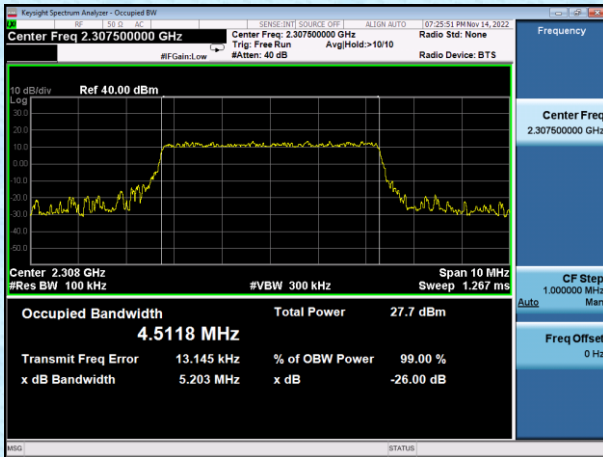

Low Channel

Low Channel

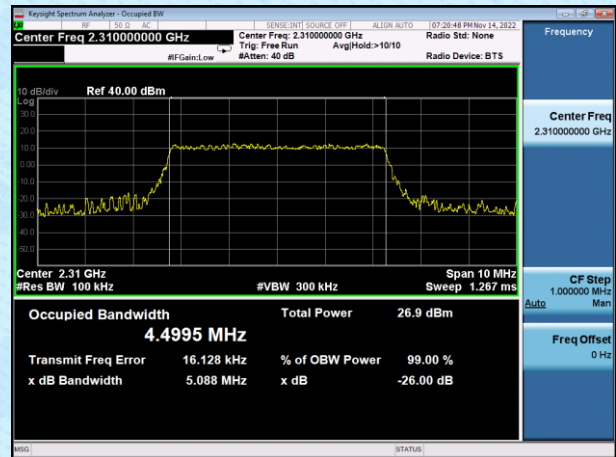
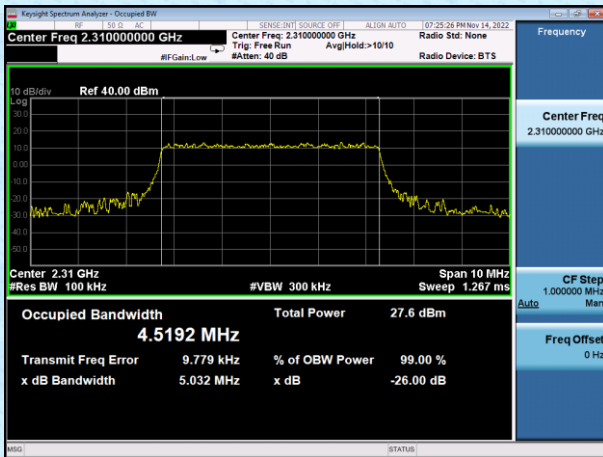

Middle Channel

Middle Channel

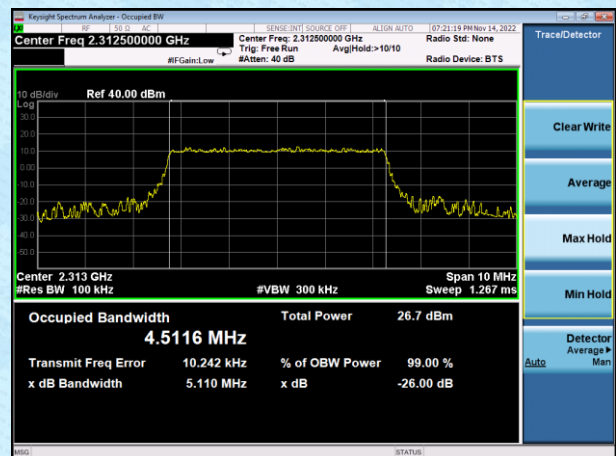
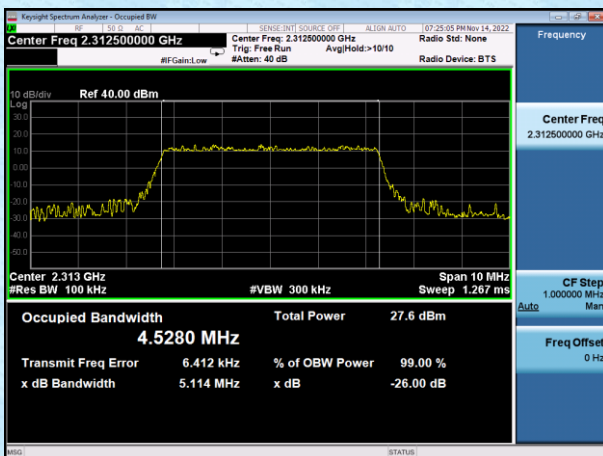

High Channel

High Channel

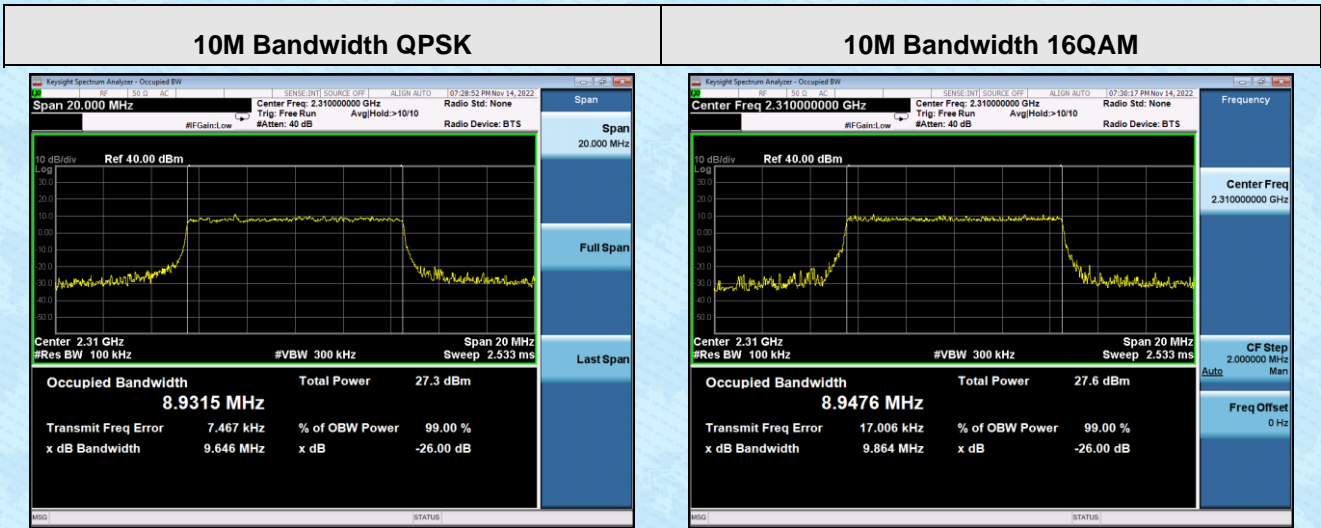

LTE Band 40 Upper

5M Bandwidth QPSK	5M Bandwidth 16QAM
--------------------------	---------------------------

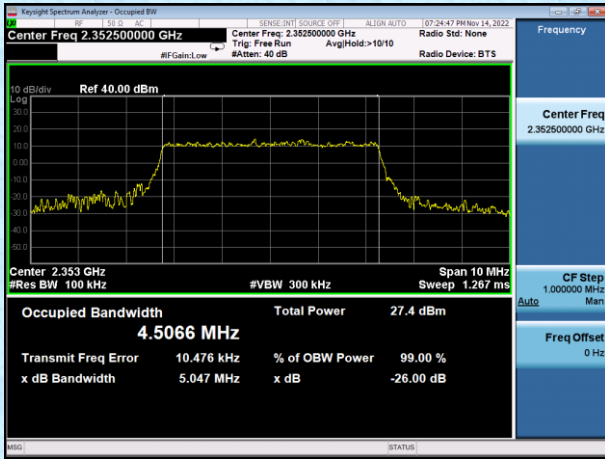

Low Channel

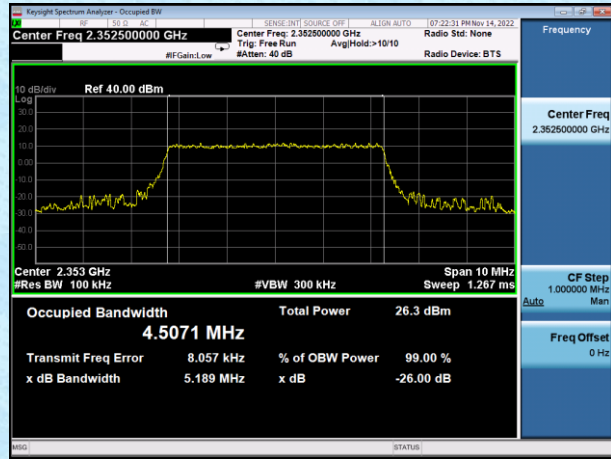

Low Channel

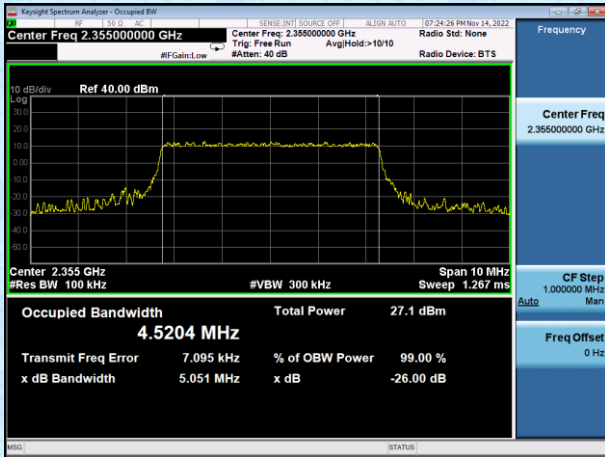

Middle Channel

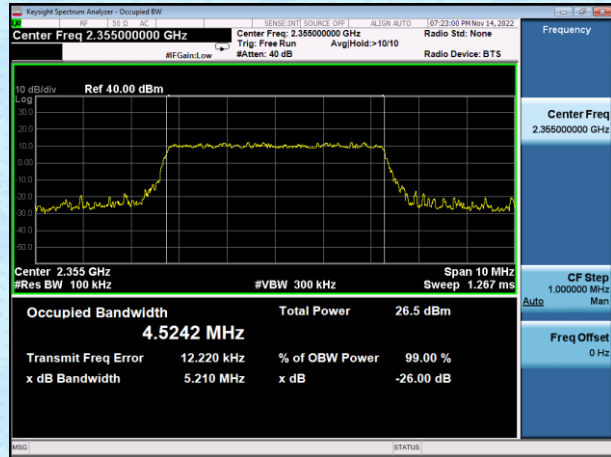

Middle Channel

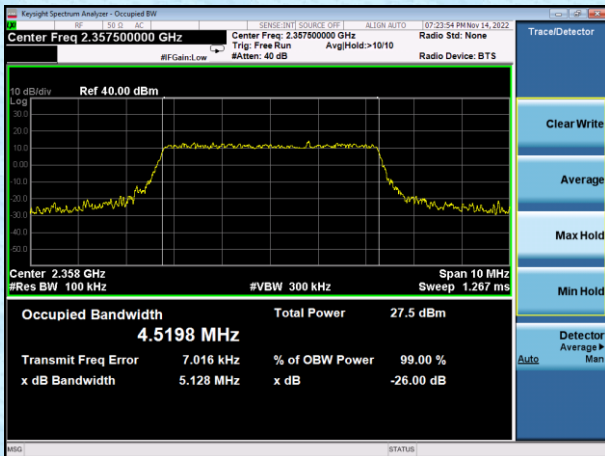

High Channel

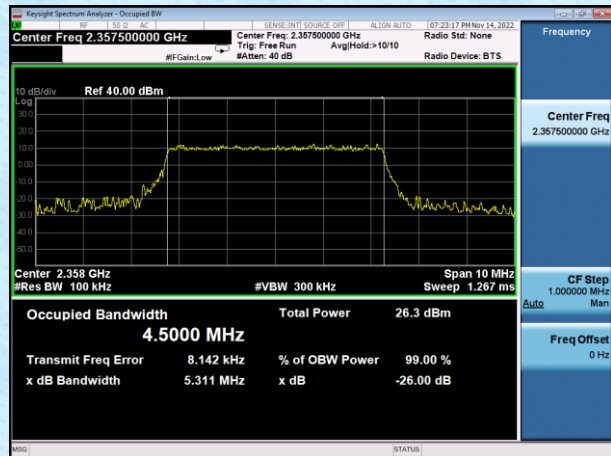

High Channel

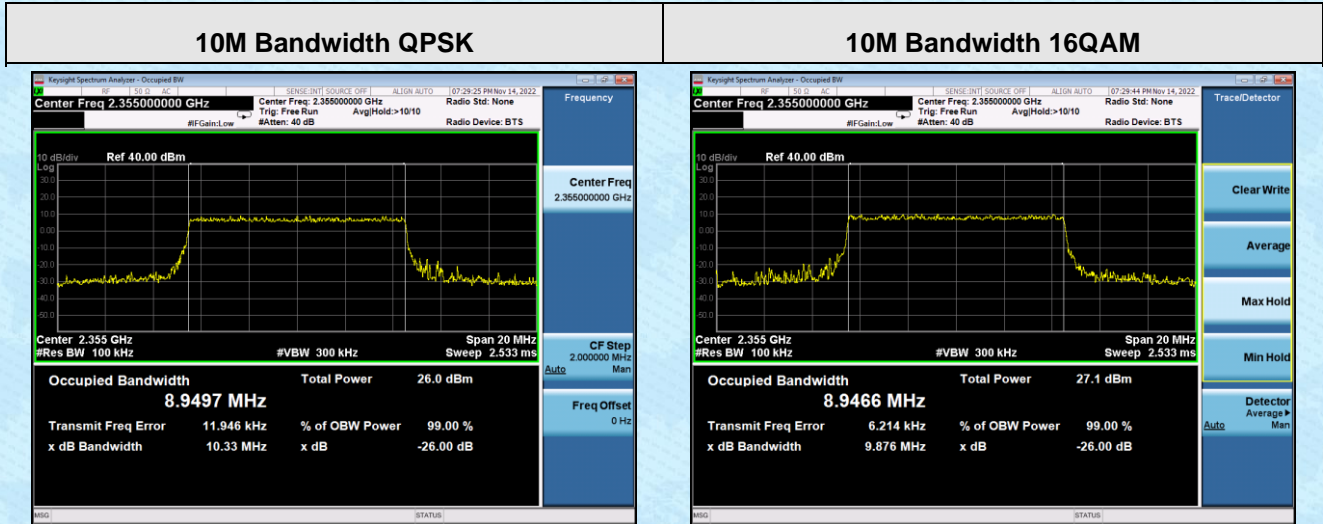

LTE Band 41

5M Bandwidth QPSK	5M Bandwidth 16QAM
--------------------------	---------------------------



Low Channel



Low Channel

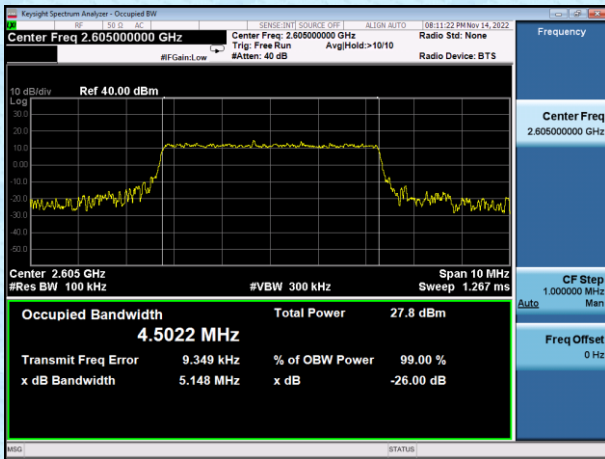

Middle Channel

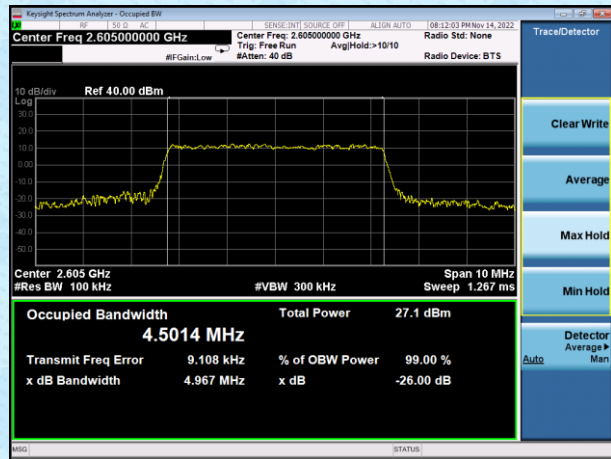

Middle Channel

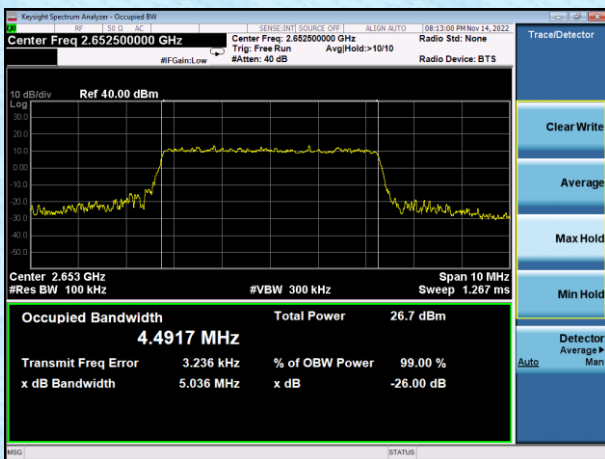

High Channel

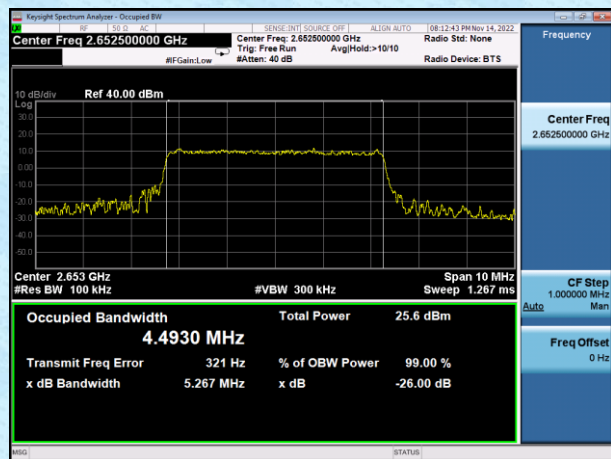

High Channel

10M Bandwidth QPSK	10M Bandwidth 16QAM
---------------------------	----------------------------

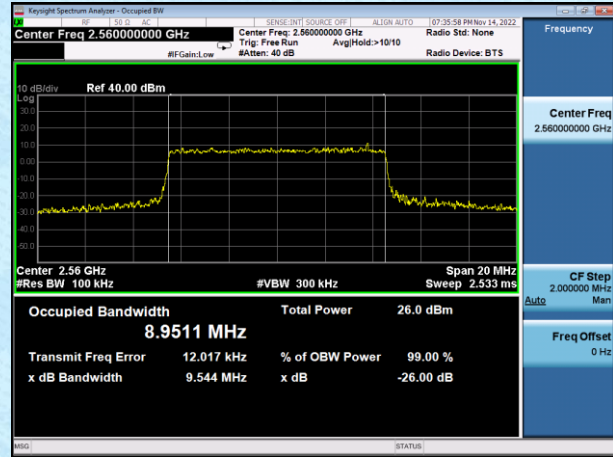

Low Channel

Low Channel

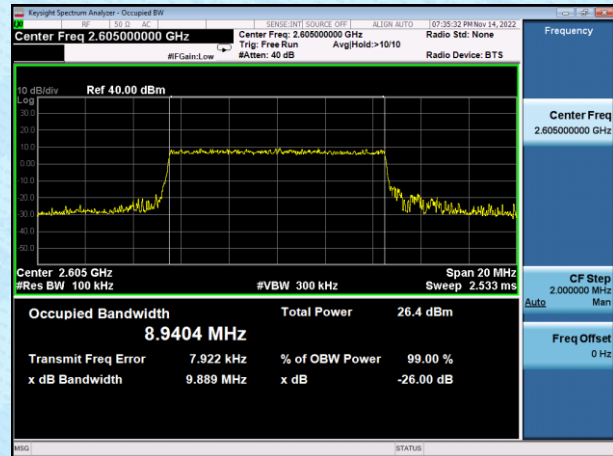
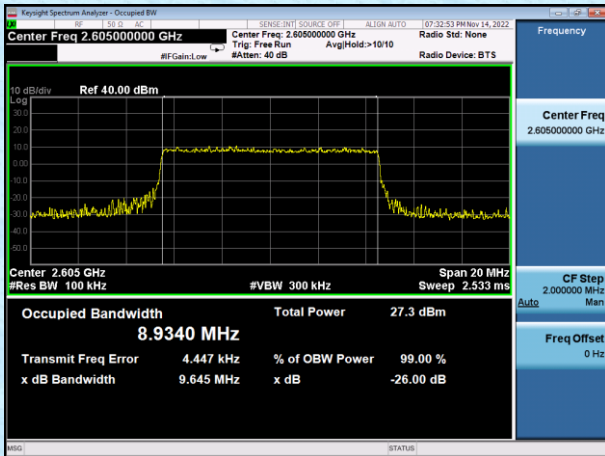

Middle Channel

Middle Channel

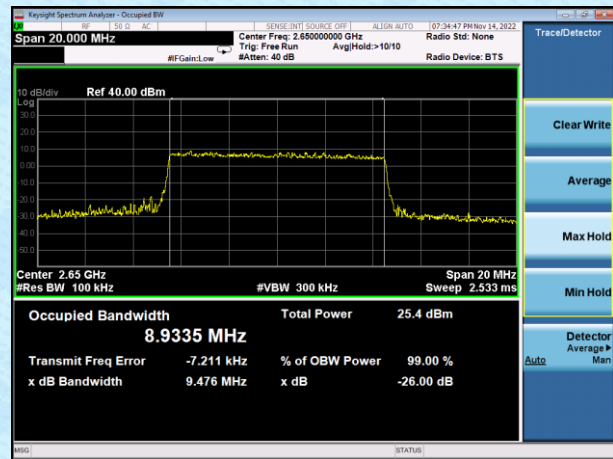
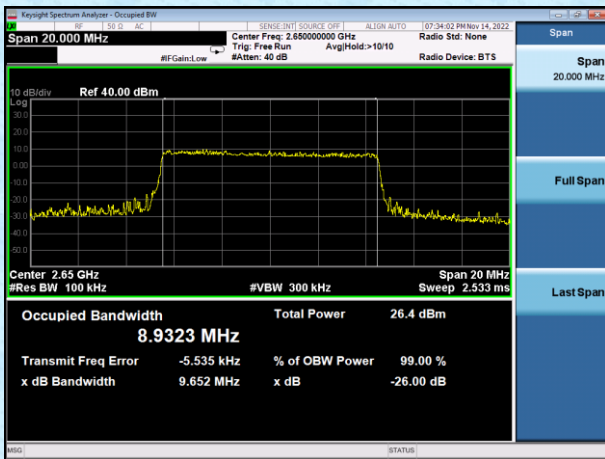

High Channel

High Channel