



*We Deliver... Lower Cost,  
Quality Products, and  
Personal Service*

## Commitment to Service

[www.ElliottElectric.com](http://www.ElliottElectric.com) · Mobile App

**Install the Elliott Electric Supply App Right Now!**



iOS



Android



- Access Your Account
- Contact Elliott Electric Supply
- View Digital Catalog
- View The Electric Times
- Link to ElliottElectric.com
- Check Order/PO Status
- Search Products
- Fingertip References
- Find Store Locations
- And Much More!

This catalog is published as a convenience to you. Prices are subject to change without notice.

Visit [ElliottElectric.com](http://ElliottElectric.com) for catalog with current pricing.



- A** Distribution Equipment
- B** Wiring Devices
- C** Lighting & Lighting Controls
- D** Wire & Cable
- E** Conduit, Fittings & Boxes
- F** Enclosures & Wireway
- G** Heating, Ventilating & Air Conditioning
- H** Motor Control
- I** Harsh Locations
- J** Datacom
- K** Tools, Terminals & Fasteners
- L** References



At Elliott Electric Supply, we are constantly thinking of new ways to assist our customers. It is our goal to provide you with truly personal service and the best time-saving tools in the industry, both before and after the purchase.

Our team includes experts who specialize in streamlining your costs with maximum convenience to you, and all of our electronic tools are developed in-house by teams of programmers invested in the quality of your experience with Elliott Electric Supply.

***We Deliver... Lower Cost, Quality Products, and Personal Service.***

## BASIC SERVICES



### PERSONAL SERVICE

We make ourselves readily available for anything you may need. We continuously conduct in-house technical training, improving our knowledge and efficiency, to directly benefit our customer relationships which sets us apart from our competitors.

### 24/7 EMERGENCY SERVICE



We provide personal phone numbers that you can call anytime something pressing comes up. Certain areas even offer special hotshot deliveries and other round-the-clock services so we can react quickly to whatever is needed, 365 days a year. Phone numbers are available online and in our app.

### HASSLE-FREE RETURNS

Any normally stocked item in resalable condition purchased from Elliott Electric Supply may be returned at any time for full credit. Some exclusions may apply.

## WE CAN HANDLE LARGER JOBS TOO

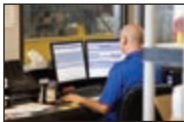

### QUOTATIONS

We can provide fast and accurate pricing quotes for jobs of any size and duration, keeping you well within your project budget. We will work closely with your Bill of Material to find areas where we can save additional costs. Quote files are always saved electronically for future reference.

### PROJECT MANAGEMENT



We can dedicate a Project Manager to assist your jobs from start to finish. We can provide a wealth of resources, including OEM manuals, shipment scheduling, on-site supply solutions, billing and order recaps, design and build services. We can even assist with freight claims on direct manufacturer shipments, project financing and more!

### ELLIOTT EMPLOYEE RESOURCES FOR INVENTORY MANAGEMENT

Sometimes projects are so big that it makes sense to have staff on-site dedicated to inventory maintenance and management. We can make this happen. You can have your very own Elliott Electric Supply facilities, materials, and personnel on hand. We'll make sure you have everything you need at all times!



## INVENTORY SERVICES



### HUGE INVENTORIES

Elliott Electric Supply has over 145 locations, with over \$140 million in inventory. This means over 100,000 different types of items and parts are available through our locations and distribution centers. Our business is modeled on the simple concept of having what you need, in-stock, all the time—something that's increasingly rare among the competition.



### PRODUCT AVAILABILITY

Our system tracks live inventory levels, and we provide you this data in real time. We transfer between our numerous locations, expedite orders from the manufacturer, provide 24/7 emergency orders and hotshot deliveries. Chances are it's in your local store, if not, it's usually only a day away. If we don't have it, we'll get it!

### REAL-TIME INVENTORY DATA

We believe it's crucial for you to know where your material is at any given moment. That's why our system tracks live inventory data at every Elliott Electric Supply location, as well as materials on delivery or transfer.

## SPECIALTY INVENTORY MANAGEMENT



### PROJECT STORAGE / JOBS THROUGH STOCK

Our space can be your space. If your project has limited room for materials, we can store materials with us for a storage fee. We'll set up a shipment schedule to bring you the right stuff at the right time.

### AUTOMATED INVENTORY MANAGEMENT (AIM)

We've developed an all-in-one procurement system which can integrate directly with your storage facilities or stocked vehicles. AIM tracks live data across multiple inventory sites to automate your replenishment process. There are two levels for AIM: AIM Basic for consignment inventories or AIM Pro, which is also referred to as CRIB Management.



### WAREHOUSE / INVENTORY AREA CONSTRUCTION

We can help supply you to design, build, and manage a highly efficient private warehouse, equipped with our custom technology and software systems. Or we can set it all up for you. Our attitude is, "anything is possible" and we're here to provide the best solutions available.

## CONSIGNMENT INVENTORIES



### DON'T MISS A SALE BECAUSE YOU DON'T HAVE IT

Elliott Electric Supply makes it easy for you to offer a wider range of products to your customers at little to no risk for you with Consignment Inventories. We will monitor what is used and restock your supply with the products you want to be available, so you will never be waiting for an order to arrive.

### ONLY PAY FOR WHAT YOU USE

Elliott Electric Supply will provide services to restock your supplies as they are used or missing on a regular schedule—automatically. You will only be billed for what you use, so there won't be any additional costs, wasted material or additional trips to the store to return unused items. With Consignment Inventories, you will always have a truck or warehouse full of the items you want in stock, without additional resources needed to maintain it.

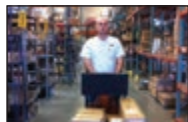

## JOB CARTS



### JOB CARTS FROM ELLIOTT ELECTRIC SUPPLY MAKE YOUR JOBS GO FASTER!

Elliott Electric Supply's Job Carts are the perfect solution to easily move parts and inventory around your jobsite. Get your material closer to the action to speed up jobs and cut labor costs.

### STOCKED AND LOCKED

All you need to do is order, and we can deliver a pre-loaded Job Cart with the parts you need. It can then be easily wheeled to the immediate installation area of your job. Concerned about security? All of our Job Carts accept padlocks to ensure only those who need to get parts can get parts.



### RACING STRIPES OPTIONAL

Our carts are mobile, so if your job pulls you down an aisle or to multiple floors, Elliott Job Carts follow alongside the work. How fast can you go now?

## ON-SITE JOB TRAILERS



### BIG JOBS MEAN BIG SERVICE

When your next major construction project demands continual service, on-site Elliott Electric Supply trailers are at your disposal. Think of it as your very own Elliott Electric Supply store right on your jobsite—no additional shipping time required. With a proven record of success, onsite Elliott Electric Supply trailers can help get your job done faster, and as always, at lower cost.



### NO PROJECT IS TOO LARGE

- We will stock the on-site supply facilities with everything you need
- You will only be billed for what you use, so just grab what you need
- We can continually monitor your supplies, ensuring availability, fitment, and replenishment as needed.

## PROJECT FINANCING



### LET US HELP YOU CLOSE A DEAL WITH YOUR CUSTOMER

Sometimes upfront costs for projects can be a financial hurdle. We can help! Elliott Electric Supply is now offering job financing to qualified owners. Terms are subject to creditworthiness. With some jobs, such as lighting retrofits or LED upgrades, the energy savings during the life of the loan may end up paying for itself. So, go ahead and get your job done!



### IDEAL FOR

- Lighting Retrofits (Schools, Professional Buildings)
- LED Upgrades
- Energy Savings Plan
- Upfront Costs
- Project Development



## ACCOUNT SERVICES



### **SAME ACCOUNT EVERYWHERE**

You can find us all across an enormous region of the South Central United States. In any of our 145+ locations you will have the same price, receive the same loaded discounts and use your same account. This can be a significant advantage to regional customers and customers who travel for jobs.

### **PERSONAL CREDIT REPRESENTATIVE**

Elliott Electric Supply assigns credit reps to accounts, so we can get to know you and your situation best. We will work with you to make sure you can finish your jobs, and we say "yes" whenever we can. All of your account balances and order details are available in real-time, online or on location.



### **ELLIOTT REWARDS\$**

You can earn a reward of \$0.10 for each and every invoice if you elect to receive invoices exclusively through email or EDI. The reward dollars can be applied to your account balance or redeemed in the form of MasterCard gift cards.

## ACCOUNT TOOLS



### **SUMMARY BILLING**

For your convenience, we can consolidate all of your billing activity for each month in a single, summarized report. Or, if you prefer weekly bill summaries, we can do that too. You can customize your Summary Billing options on our website.

### **DIRECT EMAIL FOR INVOICES & STATEMENTS**



We support a wide variety of direct email options for statements and invoicing, as well as FTP and traditional fax & mail. All email capabilities can be configured through our website. You can choose separate emails for each invoice, one email with individual attachments for each invoice, or one email with all invoices in a single document.

### **PURCHASE ORDER NUMBER FORMATTING**

We can configure our Purchase Order field to conform to your requirements to avoid billing errors and delays, and can also help avoid using the wrong account.

## EASY ORDERING



### **CUSTOM PART NUMBERS**

Use your own part numbers. We can support loading your numbers, so you can enter an order using your catalog number and when we print our ship tickets it will display your part number and ours to keep your receiving departments happy.

### **CUSTOM LISTS**



Custom Lists lets you store lists of products purchased frequently for easy reordering. Items can be easily added to Custom Lists while browsing our products, and quantities can be changed at any time. You can even add multiple copies of a list to your cart. Pre-defined "Featured Lists" can help you get started.

### **RAPID ENTRY**

Rapid Entry allows you to quickly order or quote items using Elliott Part numbers, custom part numbers, or UPC numbers through Item List or Bulk Pad. Item List features Auto-Complete, conveniently listing matching part numbers as you type. Bulk Pad lets you copy and paste parts and quantities directly from a computer.

## GET MATERIALS HOW YOU WANT THEM



### WILL CALL EXPRESS

What is the difference between Will Call and Will Call Express? Instead of coming to the counter and waiting for a free counter person, you can walk in the Will Call Express and see on a monitor if your order is ready—or better yet, we can send a text notification when your order is ready—and you can pick it up without having to wait on a counter salesman.



### FREE SCHEDULED DELIVERIES

We offer free deliveries when scheduled ahead. Same-day scheduled deliveries are often possible. We'll work with you to time deliveries as needed, whether they are daily, weekly, bi-weekly, or monthly scheduled deliveries, which saves fuel, transportation, and storage costs. Some stores also utilize truck-mounted forklifts so we can speed up unloading and put material right where you want it.

## GO MOBILE



### MOBILE APP

With the Elliott Electric Supply customer app, there are a ton of features customers can use on the go, and more are being added with every update. Order Status, PIN approval, Live Chat, digital catalog, website, events, promotions, products, references and store locations right in your pocket.



### TEXT NOTIFICATIONS

You can get select text notifications when your order is ready for pick up on Will Call orders, when your order is put on our delivery truck, when your order is the next stop, and when your order is delivered.

### COUNTER PINS

Counter PINs can be setup to secure your accounts from being used without authorization. Anyone who places an order on the counter or comes to pickup a will call will be required to give the correct PIN to complete the transaction on the secured account. PINs can be used verbally or now with our app.



See Page **C3**  
for information about  
Elliott Electric Supply's  
**LIGHTING SHOWROOM**



See Page **D3**  
for information about  
Elliott Electric Supply's  
**WIRE SERVICES**



**A**

**Distribution Equipment**

**SECTION**



**Distribution Equipment**



## Distribution Equipment

## Load Centers

Residential Overview .....	A3
CH Load Centers .....	A4–A5
CH Circuit Breakers & Accessories .....	A6
CH Surge Protection Load Centers .....	A7
BR Load Centers .....	A8
BR Circuit Breakers & Accessories .....	A9
Replacement Breakers .....	A10

## Disconnects

A/C Disconnects .....	A10
Mobile Home Service Panels .....	A10
RV Park Panels .....	A11
Temporary Power Panels .....	A11
Pressure Switch .....	A11

## Service Entrance

Meter Sockets .....	A12–A13
Service Entrance Accessories .....	A14
Roof Flashings .....	A14
Grounding Accessories .....	A14
Bonding Molds and Clamps .....	A15
Welding Shots .....	A15

## Panelboards, Breakers, Switches

Panelboards .....	A16
Molded Case Circuit Breakers .....	A17–A18
Power Defense Molded Case Circuit Breakers .....	A19
Power Xpert Release (PXR) Electronic Trip Units Features .....	A20
General Duty Switches .....	A21
Heavy Duty Switches .....	A21
Manual Transfer Switches .....	A21

## Transformers, Generators

Transformers .....	A22
Generators .....	A23
Automatic Transfer Switches .....	A23

## Fuses

Time Delay Fuses .....	A24–A26
General Purpose Fuses .....	A24
Rejection Fuses .....	A25–A26
Electronic Fuses .....	A27
Compact Circuit Protectors .....	A28
Cubefuse Fuses .....	A28





**TYPICAL BRANCH BREAKERS**

APPLIANCE	AMPERES	BREAKER
AIR CONDITIONER	50	2-Pole
CLOTHES DRYER	30	2-Pole
CLOTHES WASHER	20	1-Pole
DISHWASHER	20	1-Pole
LIGHTING	15	1-Pole
PERSONAL COMPUTER	20	1-Pole
RECEPTACLE	20	1-Pole
REFRIGERATION	20	1-Pole
STOVE	30	2-Pole



**TYPICAL RESIDENTIAL APPLICATION**

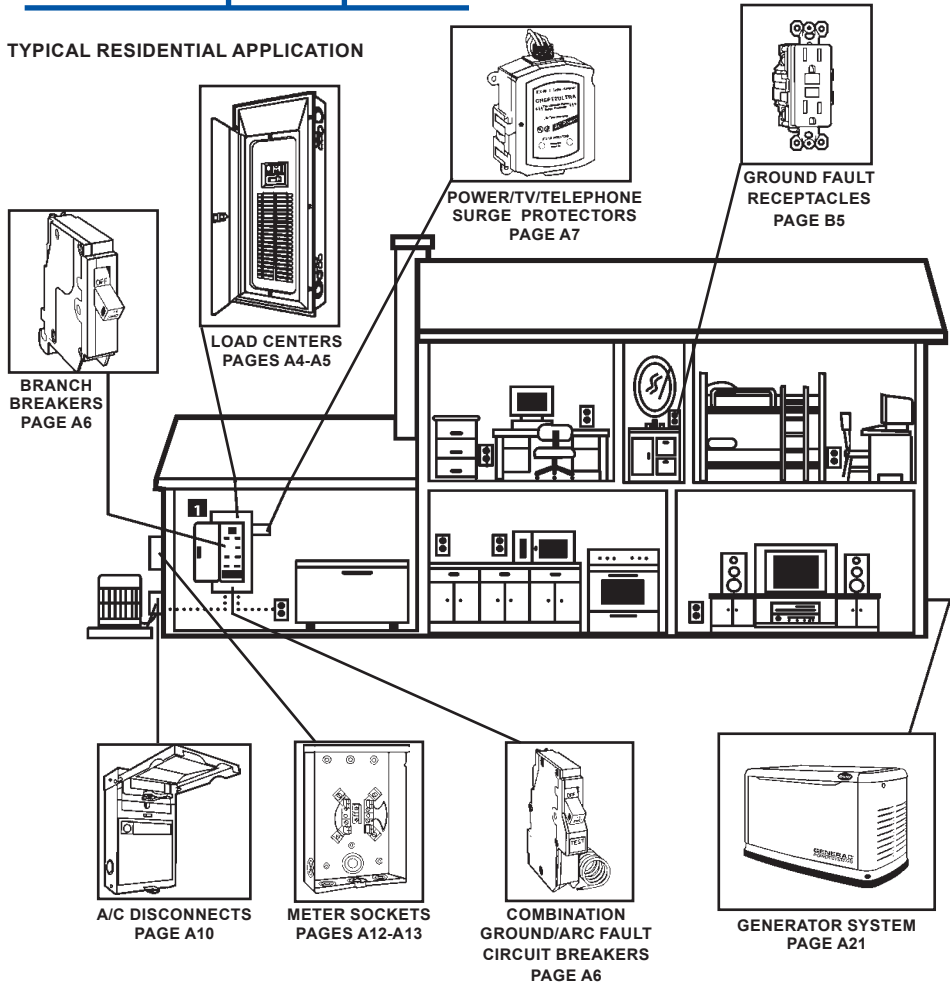



Main Breaker CH Load Centers

A

Distribution Equipment

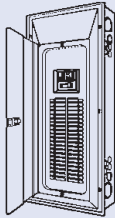

- Extra 2" knockout for bundling
- Straight in wiring, top or bottom
- 25 kAIC main breaker in 150 and 225 ampere load centers
- Steel backpan
- Silver flashed copper bus
- Single keyhole mounting
- Unique sandalwood finish
- Door packed separately to avoid loss or damage
- Split neutrals are factory bonded but removable for sub panel applications

- Improved wiring space
- "Classic" lifetime guarantee
- Improved knockout configurations
- Dry wall markings

**EXTENDED RESIDENTIAL WARRANTY**

- Lifetime warranty on CH breakers
- Lifetime load center warranty

**Items that include "PN" in the catalog number are the NEW Plug-on Neutral Load Centers**

**MAIN BREAKER LOAD CENTERS**

Vendor Code: CHD

Catalog Number	Enclosure Type	Main Amps	Max. Poles	Price Each	Cover Catalog Number		Price Each	Hub Catalog Number	Price Each
					Surface	Flush			
<b>SINGLE PHASE 3-WIRE 240V AC</b>									
CHP14B100X1	Indoor	100	14	176.79	CHPX1AS	CHPX1AF	36.17	—	—
CH14B100R	Raintight	100	14	245.35	(cover included)		—	DS200H1	17.92
CHP18B100X2	Indoor	100	18	376.77	CHPX2AS	CHPX2AF	37.31	—	—
CH18B100R	Raintight	100	18	239.79	(cover included)		—	DS200H1	17.92
CHP22B100X2	Indoor	<b>100</b>	<b>22</b>	<b>132.88</b>	CHPX2AS	CHPX2AF	70.96	—	—
CH22B100R	Raintight*	100	22	147.79	(cover included)		—	DS200H1	17.92
CHP22B125X2	Indoor	125	22	204.04	CHPX2AS	CHPX2AF	70.96	—	—
CH22B125R	Raintight	125	22	446.02	(cover included)		—	DS200H1	17.92
CHP24B150X5	Indoor	150	24	310.83	CHPX5BS	CHPX5BF	49.23	—	—
CHP24B150R	Raintight	150	24	267.58	(cover included)		—	DS200H2	25.92
CHP24B200X5	Indoor	200	24	399.46	CHPX5BS	CHPX5BF	150.52	—	—
CH24B200R	Raintight	200	24	256.42	(cover included)		—	DS200H2	25.92
CHP32B150X6	Indoor	<b>150</b>	<b>32</b>	<b>265.22</b>	CHPX6BS	CHPX6BF	151.24	—	—
CH32B150R	Raintight	150	32	311.99	(cover included)		—	DS200H2	25.92
CHP32B200X6	Indoor	<b>200</b>	<b>32</b>	<b>248.40</b>	CHPX6BS	CHPX6BF	23.37	—	—
CH32B200R	Raintight	200	32	334.34	(cover included)		—	DS200H2	25.92
CHP42B200X7	Indoor	<b>200</b>	<b>42</b>	<b>193.81</b>	CHPX7BS	CHPX7BF	204.29	—	—
CH42B200R	Raintight	200	42	278.60	(cover included)		—	DS200H2	25.92
CHP42B225X7	Indoor	225	42	355.83	CHPX7BS	CHPX7BF	204.29	—	—
CHP60B225X9	Indoor	225	60	892.13	CHPX9BF	—	133.67	—	—
<b>MOBILE HOME PANEL</b>									
CH8B200RF	Raintight	200	8	244.92	(cover included)		—	DS200H1	17.92
<b>THREE PHASE 4-WIRE 120 / 208-240V AC</b>									
CH30B3200L	Indoor	200	30	741.05	CH8LS	CH8LF	123.44	—	—
CH30B3200R	Raintight	200	30	990.13	(cover included)		—	DS200H2	25.92
CH42B3200L	Indoor	200	42	780.22	CH8LS	CH8LF	123.44	—	—
CH42B3200R	Raintight	200	42	1100.87	(cover included)		—	DS200H2	25.92

\*Top Feed Only  
 Accessories: Page A6  
 Branch Breakers: Page A6  
 Bolded Items Indicate Popular Loadcenters

2008 code requires arc-fault circuit protection on all branch circuits to family rooms, dining rooms, living rooms, bedrooms, closets, or similar areas.  
**Arc Fault Breakers: Page A6**





## Main Lug CH Load Centers

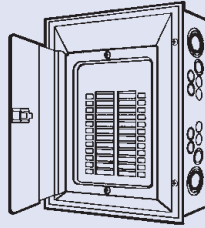

- Lifetime warranty on all CH load centers
- One-piece silver flash plated copper bus provides superior conductivity
- Steel backpan provides positive, reliable mounting.
- Unique sandalwood finish provides an aesthetically appealing, scratch resistant powder coating.
- UL listed

A  
Distribution Equipment

### MAIN LUG LOAD CENTERS

Vendor Code: **CHD**

Catalog Number	Enclosure Type	Main Amps	Max. Poles / Spaces	Price Each	Cover Catalog Number		Price Each	Hub Catalog Number	Price Each
					Surface	Flush			
<b>SINGLE PHASE 3-WIRE 240V AC</b>									
<b>CH2L40SP</b>	Surface	40	2 / 4	23.90	(cover included)		—	—	—
<b>CH2L40RP</b>	Raintight	40	2 / 4	50.25	(cover included)		—	—	—
<b>CH2L70SP</b>	Surface	70	2 / 4	28.27	(cover included)		—	—	—
<b>CH2L70RP</b>	Raintight	70	2 / 4	52.98	(cover included)		<b>DS200H1</b>	17.92	—
<b>CH2L125SP</b>	Surface	125	2 / 4	37.54	(cover included)		—	—	—
<b>CH2L125RP</b>	Raintight	125	2 / 4	61.41	(cover included)		<b>DS200H1</b>	17.92	—
<b>CH4L125SP</b>	Surface	125	4 / 4	34.49	(cover included)		—	—	—
<b>CH4L125RP</b>	Raintight	125	4 / 4	54.35	(cover included)		<b>DS200H1</b>	17.92	—
<b>CH8L125SP</b>	Surface	125	8 / 16	44.70	(cover included)		—	—	—
<b>CH8L125FP</b>	Flush	125	8 / 16	47.04	(cover included)		—	—	—
<b>CH8L125RP</b>	Raintight	125	8 / 16	68.39	(cover included)		<b>DS200H1</b>	17.92	—
<b>CHP12L125X0</b>	Indoor	125	12	64.92	<b>CHPX0AS</b>	<b>CHPX0AF</b>	36.17	—	—
<b>CHP12L125R</b>	Raintight	125	12	102.11	(cover included)		<b>DS200H1</b>	17.92	—
<b>CHP16L125X1</b>	Indoor	125	16	81.81	<b>CHPX1AS</b>	<b>CHPX1AF</b>	36.17	—	—
<b>CHP16L125R</b>	Raintight	125	16	207.79	(cover included)		<b>DS200H1</b>	17.92	—
<b>CHP20L125X2</b>	Indoor	125	20	173.30	<b>CHPX2AS</b>	<b>CHPX2AF</b>	37.31	—	—
<b>CHP24L125X2</b>	Indoor	125	24	112.29	<b>CHPX2AS</b>	<b>CHPX2AF</b>	70.96	—	—
<b>CHP24L125R</b>	Raintight	125	24	284.27	(cover included)		<b>DS200H1</b>	17.92	—
<b>CHP32L150X5</b>	Indoor	150	32	132.59	<b>CHPX5AS</b>	<b>CHPX5AF</b>	130.46	—	—
<b>CHP32L150R</b>	Raintight	150	32	316.89	(cover included)		<b>DS200H2</b>	25.92	—
<b>CHP32L225X5</b>	Indoor	225	32	147.95	<b>CHPX5AS</b>	<b>CHPX5AF</b>	49.23	—	—
<b>CHP32L225R</b>	Raintight	225	32	382.46	(cover included)		<b>DS200H2</b>	25.92	—
<b>CHP42L225X6</b>	Indoor	225	42	224.52	<b>CHPX6BS</b>	<b>CHPX6BF</b>	151.24	—	—
<b>CHP42L225R</b>	Raintight	225	42	436.86	(cover included)		<b>DS200H2</b>	25.92	—
<b>CHP60E225X9</b>	Indoor	225	60	464.75	<b>CHPX9NS</b>	<b>CHPX9NF</b>	133.67	—	—
<b>THREE PHASE 4-WIRE 120 / 208-240V AC</b>									
<b>CH6L3125SP</b>	Surface	125	6 / 12	70.43	(cover included)		—	—	—
<b>CH6L3125RP</b>	Raintight	125	6 / 12	89.33	(cover included)		<b>DS200H1</b>	17.92	—
<b>CH12L3125B</b>	Indoor	125	12	108.61	<b>CH8BS</b>	<b>CH8BF</b>	33.61	—	—
<b>CH12L3125R</b>	Raintight	125	12	175.46	(cover included)		<b>DS200H1</b>	17.92	—
<b>CH18L3125C</b>	Indoor	125	18	178.22	<b>CH8CS</b>	<b>CH8CF</b>	37.31	—	—
<b>CH18L3125R</b>	Raintight	125	18	252.96	(cover included)		<b>DS200H1</b>	17.92	—
<b>CH24L3125C</b>	Indoor	125	24	184.93	<b>CH8CS</b>	<b>CH8CF</b>	37.31	—	—
<b>CH24L3125R</b>	Raintight	125	24	280.66	(cover included)		<b>DS200H1</b>	17.92	—
<b>CH24L3225D</b>	Indoor	225	24	238.50	<b>CH8DS</b>	<b>CH8DF</b>	49.23	—	—
<b>CH30L3150D</b>	Indoor	150	30	214.42	<b>CH8DS</b>	<b>CH8DF</b>	49.23	—	—
<b>CH30L3150R</b>	Raintight	150	30	784.94	(cover included)		<b>DS200H2</b>	25.92	—
<b>CH30L3225D</b>	Indoor	225	30	240.29	<b>CH8DS</b>	<b>CH8DF</b>	49.23	—	—
<b>CH30L3225R</b>	Raintight	225	30	396.02	(cover included)		<b>DS200H2</b>	25.92	—
<b>CH42L3225G</b>	Indoor	225	42	335.51	<b>CH8GS</b>	—	72.39	—	—
<b>CH42L3225R</b>	Raintight	225	42	640.71	(cover included)		<b>DS200H2</b>	25.92	—

Accessories: Pages A6  
 Branch Breakers: Pages A6  
 Bolded Items Indicate Popular Load Centers

2008 code requires arc-fault circuit protection on all branch circuits to family rooms, dining rooms, living rooms, bedrooms, closets, or similar areas.  
**Arc Fault Breakers: Page A6**



A

Distribution Equipment

**PLUG-IN CIRCUIT BREAKERS**

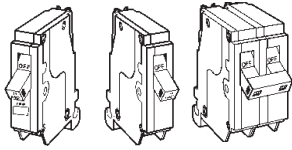

**New Trip Flag Breaker** makes it even easier! You will now see a visual indicator in the trip window whenever a breaker is tripped. The breakers also include all of the features of a standard CH breaker.

**LIFETIME WARRANTY!**

- CH style breakers are full size for full protection
- Fast magnetic tripping
- Full handle trip - no mid position
- Saves money, stops nuisance call backs
- UL Listed for use with handle tie
- Shunt trip available up to 100A. Add suffix "ST" to part number.

**SINGLE POLE**

Vendor Code: **CHD**

Catalog Number	Amps	Trip Flag	Price Each
<b>120/240V AC</b>			
CHF115	15	Y	7.56
CHF120	20	Y	7.56
CHF130	30	Y	7.94
CHF140	40	Y	8.33
CHF150	50	Y	8.75

**DOUBLE POLE**

Vendor Code: **CHD**

Catalog Number	Amps	Trip Flag	Price Each
<b>120/240V AC</b>			
CHF215	15	Y	14.93
CHF220	20	Y	14.93
CHF225	25	Y	15.38
CHF230	30	Y	15.84
CHF235	35	Y	16.32
CHF240	40	Y	16.81
CHF245	45	Y	17.31
CHF250	50	Y	17.83
CH260	60	N	19.50
CH270	70	N	42.89
CH280	80	N	50.49
CH290	90	N	50.49
CH2100	100	N	57.75
CH2125	125	N	153.17
CH2150	150	N	214.41

**THREE POLE**

Vendor Code: **CHD**

Catalog Number	Amps	Trip Flag	Price Each
<b>240V AC</b>			
CH315	15	N	147.86
CH320	20	N	147.86
CH330	30	N	147.86
CH340	40	N	147.86
CH350	50	N	147.86
CH360	60	N	147.86
CH370	70	N	191.60
CH3080	80	N	251.89
CH3090	90	N	182.88
CH3100	100	N	483.34

**PLUG-ON NEUTRAL BREAKERS**

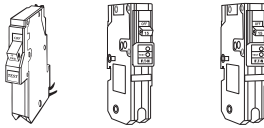

Arc Fault      Arc Fault / Ground Fault      Ground Fault

Vendor Code: **CHD**

Catalog Number	Amps	Poles	Price Each
<b>ARC FAULT*</b>			
CHFP115AF	15	1	268.99
CHFP120AF	20	1	49.74
<b>ARC FAULT/GROUND FAULT</b>			
CHFP115DF	15	1	72.86
CHFP120DF	20	1	72.86
<b>GROUND FAULT</b>			
CHFP115GF	15	1	197.79
CHFP120GF	20	1	206.84
CHN220GF	20	2	346.56
CHN230GF	30	2	346.56
CHN240GF	40	2	346.56
CHN250GF	50	2	346.56
CHN260GF	60	2	346.56

\*Must Be Used with Plug-On Neutral Load Centers that are Listed on Page A4

**STANDARD PIGTAIL BREAKERS**

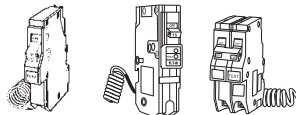

Arc Fault      Arc Fault / Ground Fault      Ground Fault

Vendor Code: **CHD**

Catalog Number	Amps	Poles	Price Each
<b>ARC FAULT*</b>			
CHFN115AF	15	2	218.97
<b>ARC FAULT/GROUND FAULT</b>			
CHFN115DF	15	1	72.86
CHFN120DF	20	1	60.72
<b>GROUND FAULT</b>			
CHFN115GF	15	1	197.79
CHFN120GF	20	1	206.84
CH220GFT	20	2	168.83
CH230GFT	30	2	168.83
CH250GFT	50	2	168.83
CH260GFT	60	2	168.83

\*2008 Code, Combination Breakers Detect Series and Parallel Faults

**TWIN SINGLE POLE BREAKERS (REQUIRES ONE POLE SPACE)**

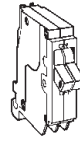

Vendor Code: **CHD**

Catalog Number	Amps	Poles	Price Each
CHT1515	15	2	25.68
CHT1520	15, 20	2	25.68
CHT2020	20	2	25.68

**SWITCHING NEUTRAL (FOR GAS PUMPS)**

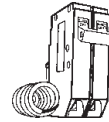

Vendor Code: **CHD**

Catalog Number	Amps	Poles	Price Each
CHF220SW	20	2	37.99

**LOAD CENTER ACCESSORIES**



CHPL

GBK

Vendor Code: **CHD**

Catalog Number	Description	Price Each
<b>BREAKER/LOADCENTER ACCESSORIES</b>		
CHHT	"CH" Handle Tie	3.17
CHLO	"CH" Handle Lock	4.49
CHFP	"CH" Filler Plate	3.02
CHPL	"CH" Breaker Lock-Out	5.77
TCD	Circuit Directory	4.43
CHPHD	"CH" 2P PON Breaker Hold Down Kit	3.75
CH125RB	"CH" Pigtail Breaker Hold Down Kit	3.67
CH9MB270	2 Circuit Mounting Base	17.61
TDL	Flush Lock	39.23

**PLUG-ON NEUTRAL GROUND BAR KITS**

GBK5	5 Terminal	13.32
GBKP10P	10 Terminal	20.13
GBKP14	14 Terminal	17.42
GBKP1420	14 Terminal + 2/0 Lug	20.41
GBKP21	21 Terminal	21.60
GBKP2120	21 Terminal + 2/0 Lug	23.60

**LEGACY GROUND BAR KITS**

GBK5	5 Terminal	9.39
GBK10	10 Terminal	9.42
GBK14	14 Terminal	11.54
GBK1420	14 Terminal + 2/0 Lug	11.72
GBK21	21 Terminal	15.36
GBK2120	21 Terminal + 2/0 Lug	16.71





## Load Centers with Surge · Surge Protection Devices

2014 NFPA Study found 34.7% of Smoke Detectors, 33% of Emergency Lighting and 18.7% CO<sup>2</sup> Detectors were found to be damaged due to surge activity.

Article 700.8 was added covering Emergency Systems. The NEC defines emergency systems in section 700.1 as "Those systems legally required and classed as emergency by municipal, state, federal, or other codes, or by any governmental agency having jurisdiction. According to the NEC, "These systems are intended to automatically supply illumination, power, or both, to designated areas and equipment in the event of failure of the normal supply or in the event of accident to elements of a system intended to supply, distribute, and control power and illumination essential for safety to human life."

A  
Distribution Equipment

### EATON COMPLETE HOME SURGE PROTECTION

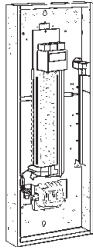

Load Center

The average home could have over \$15,000 worth of valuable electronics and appliances which are susceptible to the damaging effects of surges. A surge is an electrical disturbance that travels through your AC power and cable lines, potentially damaging home electronics and appliances.



Module

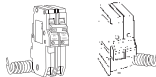

Breakers

### CH SURGE LOAD CENTERS

Vendor Code: **CHD**

Catalog Number	Main Amps	Max Poles	Required Cover Combination	Price Each
<b>MAIN BREAKER LOAD CENTERS</b>				
<b>CHSUR42B200L2</b>	200	42	CHSUR8LF	428.76
<b>CONVERTIBLE LOAD CENTERS</b>				
<b>CHSUR24L125E</b>	125	24	CHSUR8EF	535.01
<b>CHSUR32L225K</b>	225	32	CHSUR8KF	557.37
<b>CHSUR42L225L2</b>	225	42	CHSUR8LF	629.80
<b>COMBINATION COVERS</b>				
<b>CHSUR8EF</b>	Size E	24	---	63.20
<b>CHSUR8KF</b>	Size K	32	---	67.28
<b>CHSUR8LF</b>	Size L	42	---	71.39

Last Letter of Catalog Number Denotes Cover Size (E,K,L)

### LOAD CENTER SURGE MODULES BR AND CH

Vendor Code: **CHD**

Catalog Number	Description	Price Each
<b>120/240V</b>		
<b>CHSPT2SURGE</b>	Clamps 20KA @ 400V	80.35
<b>CHSPT4ULTRA*</b>	Clamps 75KA @ 400V	173.80

\*Module Included in CH Surge Ready Load Centers

### SURGE PROTECTION BREAKERS

Vendor Code: **CHD**

Catalog Number	Description	Price Each
<b>CH230SUR</b>	2-Pole 30 Amp, Clamps 36kA @ 300V	90.01
<b>CH250SUR</b>	2-Pole 50 Amp, Clamps 36kA @ 300V	90.01
<b>30KA @ 545V</b>		
<b>CHSA</b>	2-Pole, 120V Surge Arrestor	79.47

### SURGE PROTECTION DEVICES



SP1 Series



CVX Series

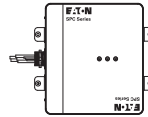

SPC Series

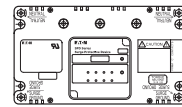

SPD Series

Vendor Code: **EPQ**

Catalog Number	Description	Price Each
<b>SP1 SERIES</b>		
<b>SP1208Y</b>	120/208 VAC, WYE, 3 Phase	202.10
<b>SP1240S</b>	120/240 VAC, Split Phase	202.10
<b>SP1480D</b>	480 VAC, Delta, 3 Phase	202.10
<b>SP1480Y</b>	277/480 VAC, WYE, 3 Phase	202.10
<b>CVX SERIES</b>		
<b>CVX100480D</b>	100KA 480VAC 3 Phase Delta N4X Surge Protector	598.99
<b>CVX100240S</b>	100KA 240VAC 3 Phase Split N4X Surge Protector	609.00
<b>CVX100208Y</b>	100KA 208VAC 3 Phase WYE N4X Surge Protector	528.12
<b>CVX050480Y</b>	50KA 480VAC 3 Phase WYE N4X Surge Protector	384.00
<b>CVX050480D</b>	50KA 480VAC 3 Phase Delta N4X Surge Protector	384.00
<b>CVX050240H</b>	50KA 240V/480V/600V 3 Phase Surge Protector	384.01
<b>SPC SERIES</b>		
<b>SPC200208Y2P</b>	200KA 120/208V WYE NEMA 4X	1591.37
<b>SPC200208Y1P</b>	200KA 120/208V WYE, Basic, NEMA 4X	1880.00
<b>SPC120240S8P</b>	120KA 120/240 Split Phase, Filter, Alarm & Form C	1200.00
<b>SPC120208Y1P</b>	120KA 120/208V WYE, Basic, NEMA 4X	1200.00
<b>SPC100240S1P</b>	100KA 120/240 Split Phase, Basic, NEMA 4X	724.08
<b>SPC050480Y2P</b>	Side Mount Surge, 240/480V	688.64
<b>SPD SERIES</b>		
<b>SPD100480Y3N</b>	100KA, WYE Standard w/Counterpkg., NEMA 4 Enc.	1162.50
<b>SPD200480D3P</b>	200KA, Delta STD w/Counter	2999.99
<b>SPD160480D2J</b>	480V Delta 60KA Standard Package, MCC APP	2275.53
<b>SPD250208Y2K</b>	120/208V WYE 250KA SD MT	2810.95
<b>SPD250480Y2K</b>	277/480V WYE 250KA SD MT	2811.02

For Product Information about Eaton's Line of Uninterruptable Power Supplies (UPS), Please See Page J7 in this Catalog.





BR Load Centers

A

Distribution Equipment

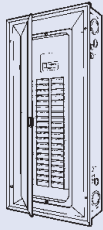

Main Breaker

- Twin neutral design for easier wiring and balancing of the load, located in wireway, away from circuit breakers
- Maximum wiring gutter space for ease of wiring in compliance with NEC requirements
- One piece roll formed metal backpan with circuit breaker alignment notches assures accurately aligned breaker and bus stabs
- Drywall marking on enclosure
- Factory pre-attached neutral bonding strap

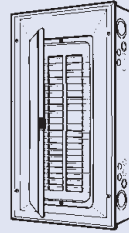

Main Lug

- Combination trim has sliding latch and adjustable deadfront for neat, clean appearance
- Extra 1-1/2" knockout for bundling of wires
- Six mounting holes (3 top, 3 bottom) for ease of installation
- Maximum variety of concentric knock outs, at rear and sides
- Same size Allen wrench can be used for phase and neutral lugs

MAIN BREAKER LOAD CENTERS

Vendor Code: ETN

Catalog Number	Enclosure Type	Main Amps	Spaces	Max. Poles	Price Each
<b>1-PHASE, 3-WIRE, 120/240V AC</b>					
<b>BRP12B100</b>	S/F Cover	100	12	12	163.32
<b>BRP12B100R</b>	Raintight	100	12	12	189.64
<b>BRP20B100</b>	S/F Cover	100	20	20	163.27
<b>BRP20B100R</b>	Raintight	100	20	20	367.77
<b>BRP20B125</b>	S/F Cover	125	20	20	326.64
<b>BRP20B125R</b>	Raintight	125	20	20	367.77
<b>BRP30B150</b>	S/F Cover	150	30	30	306.17
<b>BRP30B150R</b>	Raintight	150	30	30	434.98
<b>BRP20B200</b>	S/F Cover	200	20	20	356.99
<b>BRP20B200R</b>	Raintight	200	20	20	445.85
<b>BRP30B200</b>	S/F Cover	200	30	30	204.13
<b>BRP30B200R</b>	Raintight	200	30	30	468.45
<b>BRP40B200</b>	S/F Cover	200	40	40	265.25
<b>BRP40B200R</b>	Raintight	200	40	40	535.00
<b>BRP42BC225</b>	S/F Cover	225	42	42	410.05
<b>MOBILE HOME SERVICE PANELS</b>					
<b>BR48B200RF</b>	Raintight	200	4	8	250.81
<b>BR16B200RF</b>	Raintight	200	8	16	295.71
<b>3-PHASE, 4-WIRE, 120/208V AC</b>					
<b>3BR3042B200</b>	S/F Cover	200	30	42	816.34
<b>3BR3042B200R</b>	Raintight	200	30	42	913.28
<b>3BR4242B200</b>	S/F Cover	200	42	42	874.89
<b>3BR4242B200R</b>	Raintight	200	42	42	945.61

Branch Breakers: Page A9  
Most Popular Load Centers Indicated in **Bold**

MAIN LUG LOAD CENTERS

Vendor Code: ETN

Catalog Number	Cover Type	Main Amps	Spaces	Max. Poles	Price Each
<b>1-PHASE, 3-WIRE, 120/240V AC</b>					
<b>BR24L70RP</b>	Raintight	70	2	4	40.89
<b>BR24L125SP</b>	Surface	125	2	4	34.65
<b>BR24L125RP</b>	Raintight	125	2	4	54.21
<b>BR48L125SP</b>	Surface	125	4	8	33.43
<b>BR48L125RP</b>	Raintight	125	4	8	48.98
<b>BRP12L125</b>	S/F Cover	125	12	12	110.21
<b>BRP12L125R</b>	Raintight	125	12	12	223.85
<b>BRP16L125</b>	S/F Cover	125	16	16	137.71
<b>BRP16L125R</b>	Raintight	125	16	16	167.57
<b>BRP20L125</b>	S/F Cover	125	20	20	133.48
<b>BRP20L125R</b>	Raintight	125	20	20	201.23
<b>BRP30L200</b>	S/F Cover	200	30	30	173.42
<b>BRP30L200R</b>	Raintight	200	30	30	356.67
<b>BRP40L200</b>	S/F Cover	200	40	40	275.41
<b>BRP42LC225</b>	S/F Cover	225	42	42	292.54
<b>BR4242L225R</b>	Raintight	225	42	42	447.02
<b>3-PHASE, 4-WIRE, 120/208V AC</b>					
<b>3BR1224L125</b>	S/F Cover	125	12	24	144.07
<b>3BR1224L125R</b>	Raintight	125	12	24	197.01
<b>3BR1836L200</b>	S/F Cover	200	18	36	243.54
<b>3BR1836L200R</b>	Raintight	200	18	36	268.38
<b>3BR3042L200</b>	S/F Cover	200	30	42	401.38
<b>3BR3042L200R</b>	Raintight	200	30	42	353.06
<b>3BR4242L225</b>	S/F Cover	225	42	42	383.23
<b>3BR4242L225R</b>	Raintight	225	42	42	477.42

Most Popular Load Centers Indicated in **Bold**  
Branch Breakers: Page A9  
Hubs: Page A9  
Branch Breaker May Be Used as a Main on MLO Panel with Hold Down Kit.

COMBINATION LOAD CENTERS

Vendor Code: ETN

Catalog Number	Description	Number of Breakers	Price Each
<b>MAIN LUGS ONLY</b>			
<b>BRP12L125V24</b>	125 Amp MLO 12/24 Circuit S/F	2 BR120	529.53
<b>MAIN BREAKER</b>			
<b>BRP20B100V25</b>	100 Amp 20 Circuit S/F	2 BR120, 1 BR230	529.53
<b>BRP30B200V25</b>	200 Amp 30 Circuit S/F	10 BR120, 1 BR230	200.52
<b>BRP40B200V25</b>	200 Amp 40 Circuit S/F	2 BR120, 1 BR230	127.26



### LOAD CENTER BREAKERS

Vendor Code: **ETN**

Catalog Number	Amps	Poles	Price Each
<b>120/240V AC, SINGLE POLE</b>			
BR115	15	1	4.95
BR120	20	1	4.95
BR130	30	1	5.28
BR140	40	1	5.51
BR150	50	1	5.71
<b>DUPLEX TYPE, SINGLE POLE</b>			
BD1515	15/15	1	18.66
BD2015	20/15	1	18.66
BD2020	20/20	1	18.66
<b>120/240V AC, DOUBLE POLE</b>			
BR215	15	2	12.06
BR220	20	2	12.06
BR230	30	2	12.06
BR240	40	2	14.31
BR250	50	2	15.98
BR260	60	2	16.52
BR270	70	2	38.48
BR280	80	2	55.93
BR290	90	2	57.02
BR2100	100	2	60.31
BR2125	125	2	81.60
BJ2150*	150	2	108.30
BJ2200*	200	2	180.49
BJ2225*	225	2	180.73
<b>240V AC, THREE POLE</b>			
BR315	15	3	120.96
BR320	20	3	120.96
BR330	30	3	120.96
BR340	40	3	120.96
BR350	50	3	120.96
BR360	60	3	120.96
BR370	70	3	219.03
BR390	90	3	219.03
BR3100	100	3	219.03

\*Requires Four Spaces

### SURGE PROTECTION BREAKERS

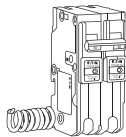

Vendor Code: **ETN**

Catalog Number	Description	Price Each
<b>120/240V</b>		
BR230SUR	2-Pole 30 Amp, clamps 36kA @ 300V	128.18
BR250SUR	2-Pole 50 Amp, clamps 36kA @ 300V	128.18



### NEW FAULT SENSING CIRCUIT BREAKERS PLUG-ON NEUTRAL

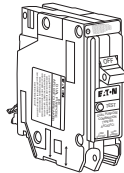

Vendor Code: **ETN**

Catalog Number	Amps	Poles	Price Each
<b>GROUND FAULT CIRCUIT INTERRUPTERS</b>			
BRP115GF	15	1	54.65
BRP120GF	20	1	54.65
<b>COMBINATION AFCI BREAKERS*</b>			
BRP115AF	15	1	48.48
BRP120AF	20	1	48.48
<b>DUAL PURPOSE AFCI/GFCI BREAKERS*</b>			
BRP115DF	15	1	55.78
BRP120DF	20	1	55.78

### PIGTAIL CIRCUIT BREAKERS

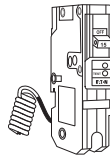

Vendor Code: **ETN**

Catalog Number	Amps	Poles	Price Each
<b>DUAL PURPOSE AFCI/GFCI BREAKERS*</b>			
BRN115DF	15	1	58.99
BRN120DF	20	1	55.78
<b>COMBINATION AFCI BREAKERS*</b>			
BRN115AF	15	1	49.79
BRN120AF	20	1	49.79
BRL215CAF	15	2	101.54
BRL220CAF	20	2	101.54
<b>GROUND FAULT CIRCUIT INTERRUPTERS</b>			
BRN115GF	15	1	59.99
BRN120GF	20	1	57.99
BRN130GF	30	1	99.99
GFTCB215	15	2	122.39
GFTCB220	20	2	122.39
GFTCB230	30	2	122.39
GFTCB240	40	2	122.39
GFTCB250	50	2	122.39
GFTCB260	60	2	144.52

\*2008 Code, When Adopted, Requires Combination Arc Fault Breakers

### LOAD CENTER HUBS CH & BR

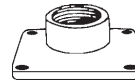

Vendor Code: **GHD**

Catalog Number	Conduit Size	Price Each
<b>PANELS LESS THAN 200A MAIN</b>		
DS075H1	3/4"	16.21
DS100H1	1"	16.77
DS125H1	1-1/4"	17.33
DS150H1	1-1/2"	17.88
DS200H1	2"	17.92
<b>200A AND LARGER MAIN</b>		
DS200H2	2"	25.92
DS250H2	2-1/2"	47.08
DS300H2	3"	43.90

### LOAD CENTER ACCESSORIES

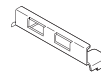

BRLW

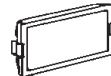

BRFP



BREQS125



BRHDK125

Vendor Code: **ETN**

Catalog Number	Description	Price Each
BRLW	"BR" Lock Off	6.98
BRFP	"BR" Filler Plate	5.09
BREQS125	BR Hold Down Kit for 2 Pole up to 125A	5.11
BRHDK125	BR Hold Down Kit for 2 Pole 150-225A	6.15
BRPHD	BR Hold Down Kit for 2 Pole PON Breaker	6.14

### PLUG-ON SURGE PROTECTION

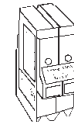

- Basic surge protection installs in first two stabs of load center, just like a breaker
- Includes indicator LED that lights up if any internal components are damaged

Vendor Code: **ETN**

Catalog Number	Description	Price Each
<b>120/240V</b>		
BR5URGE	Clamps 10kA @ 545V	89.51



A

Distribution Equipment

**EATON MAIN BREAKERS  
CONVERTIBLE LOAD CENTERS**

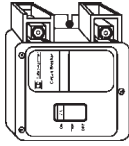

BW

Vendor Code: **ETN**

Catalog Number	Description	Price Each
<b>25 KAIC SINGLE PHASE</b>		
BW2125	2-Pole, 125 Amp	108.38
BW2150	2-Pole, 150 Amp	118.59
BW2200	2-Pole, 200 Amp	118.59
BW2225	2-Pole, 225 Amp	91.91

**REPLACEMENT MAIN BREAKERS  
FOR OLD STYLE AND  
3-PHASE LOAD CENTERS**

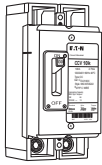

CCV Style

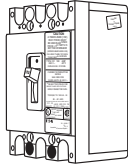

CC Style

Vendor Code: **CHD**

Catalog Number	Description	Price Each
<b>10 KAIC SINGLE PHASE</b>		
CCV2100	2-Pole, 100 Amp	326.39
CCV2125	2-Pole, 125 Amp	168.42
CCV2150	2-Pole, 150 Amp	168.42
CCV2200	2-Pole, 200 Amp	301.04
CCV2225	2-Pole, 225 Amp	301.04
<b>25 KAIC THREE PHASE</b>		
CC3100	3-Pole, 100 Amp	427.02
CC3125	3-Pole, 125 Amp	663.08
CC3150	3-Pole, 150 Amp	663.08
CC3200	3-Pole, 200 Amp	663.04
CC3225	3-Pole, 225 Amp	663.08



**SQUARE D TYPE QO  
REPLACEMENT BREAKERS**



**15 YEAR LIMITED WARRANTY**

Vendor Code: **CHD**

Catalog Number	Amps	Price Each
<b>SINGLE POLE</b>		
CHQ115	15	10.42
CHQ120	20	10.42
CHQ130	30	10.42
CHQ140	40	10.42
CHQ150	50	10.54
<b>DOUBLE POLE</b>		
CHQ215	15	24.53
CHQ220	20	24.53
CHQ230	30	23.04
CHQ240	40	24.53
CHQ250	50	24.53
CHQ260	60	24.35

UL Listed for Use in SQ D QO Series Load Centers in Single Phase, 3 Wire, 120/240V, 10,000 AIC Applications.

**REPLACEMENT BREAKERS  
FOR GE, SIEMENS,  
AND SQUARE D HOMELINE**

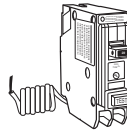
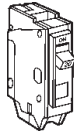

Vendor Code: **ETN**

Catalog Number	Amps	Price Each
<b>SINGLE POLE</b>		
CL115	15	7.25
CL120	20	7.25
CL130	30	7.66
CL140	40	7.66
CL150	50	7.71
<b>DOUBLE POLE</b>		
CL215	15	85.08
CL220	20	15.30
CL230	30	15.30
CL240	40	15.43
CL250	50	15.40
<b>SINGLE POLE GFCI</b>		
CL120GFT	20	57.68
<b>SINGLE POLE, COMBINATION ARC FAULT</b>		
CL115CAF	15	62.27
CL120CAF	20	62.27

UL listed for Use in GE, Siemens, Thomas & Betts, and Square D Homeline Series Load Centers.

**A/C DISCONNECTS**

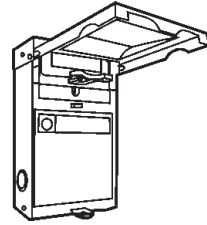

- Pull out type with dead front
- NEMA Type 3R
- Galvanized steel enclosure

Vendor Code: **CHD**

Catalog Number	Description	Price Each
<b>SINGLE PHASE 60 AMP</b>		
DPU222R	Pullout Non-Fusible	16.89
DPF222R	Pullout Fusible	25.81
DPB222R	Molded Case Switch	29.15
DPU222RGF20T	Non-Fusible w/20A GFI Rec	72.65
<b>THREE PHASE 60 AMP</b>		
DPU362RA	Non-Fusible	131.14

**MOBILE HOME  
SERVICE PANELS**

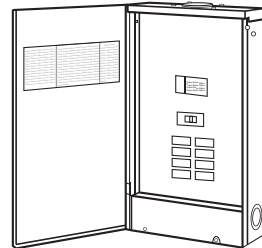

Vendor Code: **CHD**

Catalog Number	Description	Price Each
CH8B200RF	200A Main Breaker 8 Branch Circuits #4-300 Feed Thru Lugs	244.92

Branch Breakers: Page A6

Vendor Code: **ETN**

Catalog Number	Description	Price Each
BR48B200RF	200A Main Breaker 4/8 Branch Circuits #4-300 Feed Thru Lugs	250.81
BR816B200RF	200A Main Breaker 8/16 Branch Circuits #4-300 Feed Thru Lugs	295.71

Branch Breakers: Page A9





## RV Park Panels · Temporary Power Panels · Pressure Switch

### RV PARK PANELS

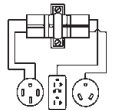
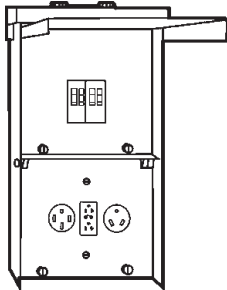

CHU1N7N4NS

- 1-50A - 2P
- 1-30A - 1P
- 1-20A - 1P

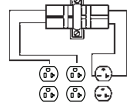

CHU6G6G5S

- 2-20A - 1P GFI
- 1-20A - 2P

Vendor Code: **CHD**

Catalog Number	Description	Price Each
<b>CHU1N7N4NS</b>	1-50A, 220V RV Recept. 1-30A, 120V Travel Trailer Recept. 1-20A, 120V GFI Recept.	183.83
<b>CHU6G6G5S</b>	2-20A, 120V Recept. 1-20A, 220V Recept.	795.96

Hubs: Page A12

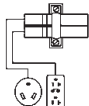

CHU4N7NS

- 1-30A - 1P Non-GFI
- 1-20A - 1P GFI

Vendor Code: **CHD**

Catalog Number	Description	Price Each
<b>CHU4N7NS</b>	1-30A, 120V Travel Trailer Recept. 1-20A, 120V GFI Recept.	188.80

Hubs: Page A12



### TEMPORARY POWER PANELS FOR CONSTRUCTION SITES

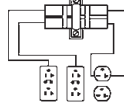
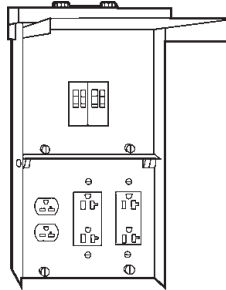

CHU7N7N5NS

- 2-20A-1P Non-GFI
- 1-20A-2P Non-GFI

CHU2G2GKGS

- 2-20A-1P GFI
- 1-20A-2P GFI

Vendor Code: **CHD**

Catalog Number	Description	Price Each
<b>CHU7N7N5NS</b>	2-20A, 120V GFI Rec. 1-20A, 220V Rec.	204.13
<b>CHU2G2GKGS</b>	2-20A, 120V Rec. 1-20A, 220V Rec.	312.82

Hubs: Page A12

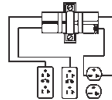

CHU7N7N5GS

- 2-20A - 1P Non-GFI
- 1-20A - 2P GFI

CHU7N7N5NS

- 2-20A - 1P Non-GFI
- 1-20A - 2P

Vendor Code: **CHD**

Catalog Number	Description	Price Each
<b>CHU7N7N5GS</b>	1-20A, 120V GFI Recept. 1-20A, 220V Recept.	270.34
<b>CHU7N7N5NS</b>	2-20A, 120V GFI Recept. 1-20A, 220V Recept.	204.13

Hubs: Page A12

### TEMPORARY POWER PANEL WITH METER SOCKET

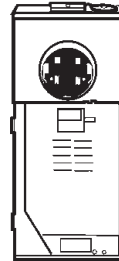

Vendor Code: **ETN**

Catalog Number	Description	Price Each
<b>MB816B200BTS</b>	OH/UG Service 200A 4 Jaw Ringless Meter Socket 200A 8/16 Circuit Main Breaker Load Center	228.76

\*Approved for Use in SWEPCO Service Territory. Check Local Listings for More Information.

### SINGLE RECEPTACLE POWER OUTLET PANELS



- NEMA 3R construction for rainproof installation.
- Surface mount
- Pad lockable
- In use cover design

Vendor Code: **CHD**

Catalog Number	Description	Price Each
<b>CHU1S</b>	50 Amp, 250V, NEMA 14-50R	47.04
<b>CHU3S</b>	30 Amp, 250V, NEMA 14-30R	46.95
<b>CHU4S</b>	30 Amp, 250V, NEMA TT-30R	47.03

See NEMA Straight Blade Configuration Chart on Page L16.

### PRESSURE SWITCH

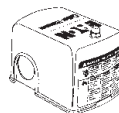

Vendor Code: **CHC**

Catalog Number	Description	Price Each
<b>CHWPS2040D</b>	20-40 PSI NEMA 1	23.11

A

Distribution Equipment



A

Distribution Equipment

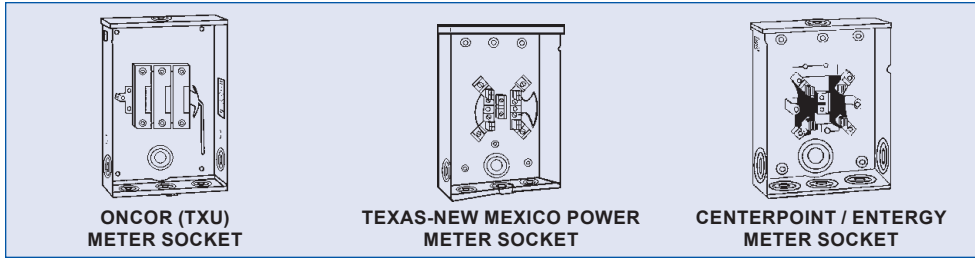

**ONCOR (TXU)  
METER SOCKET**

**TEXAS-NEW MEXICO POWER  
METER SOCKET**

**CENTERPOINT / ENTERGY  
METER SOCKET**

**ONCOR (TXU)**

Vendor Code: **CHD**

Catalog Number	Description	Price Each
<b>SINGLE PHASE</b>		
UTRS502BCH	150A OH	60.20
UTRS213CE	200A OH/UG	53.09
UTE4213ZCH	200A OH/UG HD	224.52
UTH43369TCH*	320A OH/UG HD SWY	291.84
<b>THREE PHASE</b>		
UTE7213THLCH	200A OH/UG HD	290.82
UTH73369TCH*	320A OH/UG HD SWY	484.68

\*Line/Load Lugs Required

**TEXAS-NEW MEXICO  
POWER**

Vendor Code: **CHD**

Catalog Number	Description	Price Each
<b>SINGLE PHASE</b>		
UTRS101BE	125A OH	48.44
UTRS213CE	200A OH	53.09
UTRS223ACH	200A UG	75.47
UTH4330TCH*	320A OH/UG	412.57
<b>THREE PHASE</b>		
UTE7213BCH	200A OH/UG HD	244.87
UTH7330TCH*	320A OH/UG HD	1808.50

\*Line/Load Lugs Required

**ENTERGY**

Vendor Code: **CHD**

Catalog Number	Description	Price Each
<b>SINGLE PHASE</b>		
UTRS101BE	125A OH	48.44
UTRS213BE	200A OH/UG	67.45
UTRS223ACH	200A UG SWY	75.47
UTH43369UCH*	320A OH/UG HD SWY	265.27
<b>THREE PHASE</b>		
UTE7213TCH	200A OH/UG HD	255.01
UTH43369UCH*	320A OH/UG HD SWY	265.27

\*Line/Load Lugs Required

**CENTERPOINT (H P&L)**

Vendor Code: **CHD**

Catalog Number	Description	Price Each
<b>SINGLE PHASE</b>		
UNRRS101BEUSE	125A OH	67.42
UNRRS213CEUSE	200A UG	114.04
1009260CH*	320A OH/UG Comm. HD	490.30
CH8523K4*	400A OH/UG Resi.	569.53
<b>THREE PHASE</b>		
1009097CH	200A OH/UG	280.62
UTH7330UCH*	320A OH/UG HD SWY	601.95

\*Line/Load Lugs Required

**ARIZONA PUBLIC SERVICE**

Vendor Code: **CHD**

Catalog Number	Description	Price Each
<b>SINGLE PHASE</b>		
CH114TB	125A OH/UG	593.94
CH124TB	200A OH/UG	1097.25
<b>THREE PHASE</b>		
CH127TB	200A OH/UG HD	1486.56

**SALT RIVER PROJECT**

Vendor Code: **CHD**

Catalog Number	Description	Price Each
<b>SINGLE PHASE – RESIDENTIAL</b>		
URTRS101BE	125A OH/UG	144.54
URTRS202BCH	200A OH/UG	229.50
<b>SINGLE PHASE – COMMERCIAL</b>		
CH114TB	125A OH/UG	593.94
CH124TB	200A OH/UG	1097.25
<b>THREE PHASE</b>		
CH127TB	200A OH/UG HD	1486.56

**HUBS**

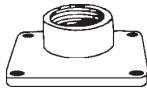

Vendor Code: **CHD**

Catalog Number	Description	Price Each
<b>SMALL OPENING (STANDARD)</b>		
ARP00004CH12	1-1/4" Hub	10.25
ARP00005CH15	1-1/2" Hub	10.25
ARP00006CH2	2" Hub	11.22
ARP00007CH25	2-1/2" Hub	12.28
<b>LARGE OPENING (HEAVY DUTY)</b>		
ARP00019CH3	3" Hub	38.93
ARP00021CH4	4" Hub	61.31
ARP00002CHB	Small Hub Closing Plate	6.15
ARP00016CHB	Large Hub Closing Plate	9.69
ARP00015CHAP	Hub Opening Adapter Large Hub to Small	12.77

**LINE/LOAD LUGS**



Vendor Code: **TAB**

Catalog Number	MCM	Price per 100 pcs.
<b>SINGLE</b>		
ADR35	350	581.68
ADR60	600	931.91
ADR80	800	1247.83
<b>TWIN</b>		
ADR3521	350	1208.19

Required for 320A and Larger Meter Sockets

320 Amp meter-cans do not include line/load lugs

- OH = Overhead
- UG = Underground
- HD = Heavy Duty Lever Bypass
- SWY = Side Wireway, meter is offset to one side of the can

Contact your power company for meter-can compatibility.

**Thomas & Betts**  
A Member of the ABB Group





## Milbank Meter Sockets · Hubs

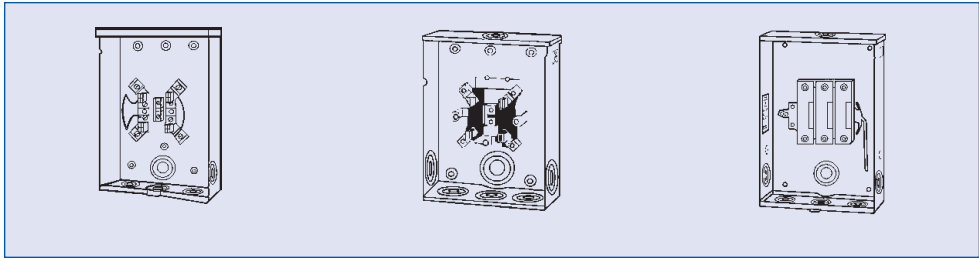

**A**  
Distribution Equipment

### ONCOR (TXU)

Vendor Code: **MIB**

Catalog Number	Description	Price Each
<b>SINGLE PHASE</b>		
<b>U7262RLTG</b>	150A OH	77.54
<b>U7040XLTG</b>	200A OH/UG	59.86
<b>U17970K3LK2L</b>	320A UG SWY	279.99
<b>THREE PHASE</b>		
<b>U9701RXL</b>	200A OH/UG HD	440.95
<b>U4013X</b>	320A OH/UG SWY	519.99

### TEXAS-NEW MEXICO POWER

Vendor Code: **MIB**

Catalog Number	Description	Price Each
<b>SINGLE PHASE</b>		
<b>U8435RLTG</b>	125A OH	88.17
<b>U7021RLTG</b>	200A OH	110.24
<b>U19800</b>	200A UG SWY	92.02
<b>U2448X</b>	200A OH/UG	519.99
<b>THREE PHASE</b>		
<b>U9701RRL</b>	200A OH/UG HD	418.89
<b>U2594X</b>	320A OH/UG HD SWY	689.99

### ENTERGY

Vendor Code: **MIB**

Catalog Number	Description	Price Each
<b>SINGLE PHASE</b>		
<b>U8435RLTG</b>	125A OH/UG	88.17
<b>U7040RLTG</b>	200A OH/UG	121.26
<b>U4505X</b>	320A OH/UG HD	396.85
<b>THREE PHASE</b>		
<b>U4701RLQG</b>	200A OH/UG HD	379.99
<b>U2594X</b>	320A OH/UG HD	689.99

### CLECO

Vendor Code: **MIB**

Catalog Number	Description	Price Each
<b>SINGLE PHASE</b>		
<b>U8435RLTG</b>	125A OH/UG	88.17
<b>U7021DLTG</b>	200A OH/UG	110.23
<b>U19800</b>	200A UG SWY	92.02
<b>U4257X</b>	320A OH/UG HD	540.16
<b>THREE PHASE</b>		
<b>U4701RLQG</b>	200A OH/UG	379.99
<b>U2594X</b>	320A OH/UG	689.99

### EXCEL

Vendor Code: **MIB**

Catalog Number	Description	Price Each
<b>SINGLE PHASE</b>		
<b>U4801XL5T9</b>	200A OH/UG HD	179.99
<b>U1779R5T9</b>	320A OH/UG HD	385.84
<b>THREE PHASE</b>		
<b>U2049RL</b>	200A OH HD RL	374.81
<b>U9701RRL</b>	200A OH/UG HD RL	418.89
<b>U2594X</b>	320A OH/UG HD	689.99

### SALT RIVER PROJECT ARIZONA PUBLIC SERVICE TUCSON ELECTRIC POWER

Vendor Code: **MIB**

Catalog Number	Description	Price Each
<b>SINGLE PHASE - RESIDENTIAL</b>		
<b>U7490RL</b>	125A OH/UG RING TYPE	86.28
<b>U4518XLW</b>	200A OH/UG RING TYPE	159.93
<b>M400UGAPSLC</b>	320A UG RING TYPE	1773.65
<b>SINGLE PHASE - COMMERCIAL</b>		
<b>114TB</b>	100A OH/UG	479.10
<b>124TB</b>	200A OH/UG	886.32
<b>THREE PHASE</b>		
<b>127TB</b>	200A OH/UG	1185.38

### HUBS

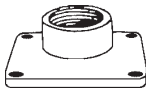

Vendor Code: **MIB**

Catalog Number	Size	Price Each
<b>SMALL OPENING (STANDARD)</b>		
<b>A7514</b>	1"	9.46
<b>A7515</b>	1-1/4"	9.98
<b>A7516</b>	1-1/2"	10.46
<b>A7517</b>	2"	10.97
<b>A7518</b>	2-1/2"	11.44
<b>LARGE OPENING (HEAVY DUTY)</b>		
<b>A8110</b>	3"	41.87
<b>A8112</b>	4"	49.59
<b>ACCESSORIES</b>		
<b>A7551</b>	Small Closing Plate	8.25
<b>A9064</b>	Large Closing Plate	11.02
<b>S8324</b>	Hub Adapter for R to RL	8.99

320 Amp meter-cans do not include line/load lugs

- OH = Overhead
- UG = Underground
- HD = Heavy Duty Lever Bypass
- SWY = Side Wireway, meter is offset to one side of the can
- RL = Ringless

Contact your power company for meter-can compatibility.





Distribution Equipment

**WEATHERHEAD  
ENTRANCE CAPS**



Vendor Code: **BRI** (Bridgeport Fittings)

Catalog Number	Size	Price per 100 pcs.
<b>RIGID &amp; EMT</b>		
1251	1/2"	408.00
1252	3/4"	476.32
1253	1"	554.88
1254	1-1/4"	568.13
1255	1-1/2"	962.87
1256	2"	1203.59
1257	2-1/2"	4056.52
1258	3"	6087.35
1259	3-1/2"	8769.95
1260	4"	9944.99

Vendor Code: **PVF** (Cantex, Inc.)

Catalog Number	Size	Carton Quantity	Price per 100 pcs.
<b>PVC WEATHERHEADS</b>			
5133742	1-1/4"	20	883.67
5133695	1-1/2"	20	1067.16
5133743	2"	5	1776.95
5133697	3"	2	8192.35
5133699	4"	2	21926.96

**SERVICE ENTRANCE  
HARDWARE**

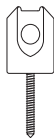

SW1BB



W32

Vendor Code: **TAB**

Catalog Number	Type	Price per 100 pcs.
<b>SCREW IN TYPE</b>		
SW1BB	Midget Insulator	180.00
SW2BB	Medium Duty Insulator	940.10
SW3BB	Heavy Duty Reinforced	1469.52
<b>CLAMP ON TYPE</b>		
W32	Insulator for 2" Pipe	1561.46
W33	Insulator for 2-1/2" Pipe	1729.62

**WEDGE CLAMPS**



Vendor Code: **TAB**

Catalog Number	Conduit Range	Price per 100 pcs.
W621	#1 Stranded - #6 Solid Aluminum	596.59
W201	#2/0 Stranded - #2 Solid	782.94
W401	#4/0 Stranded - #2/0 Solid	1094.96

**ROOF FLASHINGS**



RF125

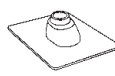

RFN200

Vendor Code: **BRI**

Catalog Number	Size	Price per 100 pcs.
<b>GALVANIZED ROOF FLASHING</b>		
RF125*	1-1/4"	1087.72
RF200*	2"	1112.36
RF250*	2-1/2"	1173.67
<b>NEOPRENE ROOF FLASHING</b>		
RFN200	2"	1484.09
RFN300	3"	1819.67

\*Neoprene Collar Included

**GROUND RODS**



Vendor Code: **CDW**

Catalog Number	Size	Bundle Quantity	Price per 100 pcs.
<b>BONDED COPPER</b>			
611360	1/2" x 6'	5	1116.37
611380	1/2" x 8'	5	1468.94
615860	5/8" x 6'	5	1283.64
615880	5/8" x 8'	5	1481.82
615800	5/8" x 10'	5	1912.73
613480	3/4" x 8'	5	2476.37
613400	3/4" x 10'	5	2754.56
<b>GALVANIZED</b>			
815860	5/8" x 6'	5	825.46
815880	5/8" x 8'	5	1016.37

**GROUND CLAMPS**



GZ1  
or G1SDB



GCA1  
or G1S



GRC

Vendor Code: **NSI**

Catalog Number	Description	Ctn. Qty.	Price per 100 pcs.
<b>DIE CAST - UL LISTED</b>			
GZ1	1/2 - 1" Pipe	25	251.67
<b>ALUMINUM</b>			
GCA1	1/2" - 1" Pipe	25	722.73
GCA2	1-1/4" - 2" Pipe	10	1238.47
GCA4	2-1/2" - 4" Pipe	3	3163.28
<b>BRONZE - UL LISTED</b>			
G1S	1/2" - 1" Pipe	20	352.53
G2S	1-1/4" - 2" Pipe	10	809.57
G4S	2-1/2" - 4" Pipe	6	3189.76
<b>BRONZE - UL LISTED DIRECT BURIAL</b>			
G1SDB	1/2" - 1" Pipe	20	564.35
<b>SILICON BRONZE - UL LISTED</b>			
GRC3834**	3/8" - 3/4" Gr. Rod	25	254.54
GRC58	5/8" Ground Rod	25	281.97

\*\*Contains Brass Screws

\*The GRC Fits 1/2", 5/8" and 3/4"

**GEM**

**GROUND ENHANCEMENT MATERIAL**



Ground Enhancement Material (GEM) is a superior conducting material that solves your toughest grounding problems. It is the ideal material to use in areas of poor conductivity, such as rocky ground, mountain tops and sandy soil. GEM dramatically reduces earth resistance and impedance measurements. Furthermore, GEM may reduce the size of the grounding system where conventional methods are unsatisfactory. Once installed, GEM is maintenance-free, not requiring periodic charging or the presence of water to maintain its conductivity.

Vendor Code: **CDW**

Catalog Number	Description	Price Each
GEM25A	25lb Bag	47.98

**GALVANIZED STEEL  
GROUNDING PLATE**



- Provides a large surface area to dissipate current into the ground
- Includes a welded steel rod pigtail

Vendor Code: **CDW**

Catalog Number	Description	Price Each
EGGP	1/4"X10"X16" Plate	48.97

**GROUNDING BONDING  
INTERSYSTEM**

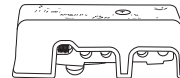

Vendor Code: **NSI**

Catalog Number	Description	Price Each
GBIBZ1264414WC	Intersystem Bonding Connector	11.73





## Cadweld Molds and Clamps

### CADWELD HANDLE CLAMPS

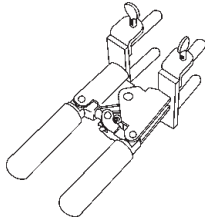

Vendor Code: **CDW**

Catalog Number	Description	Price Each
<b>L160</b>	Handle Clamps for C, E, Q and R Series	105.46

### CHAIN SUPPORT HANDLE CLAMPS FOR VERTICAL PIPE

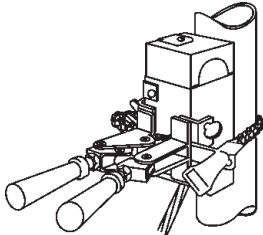

Vendor Code: **CDW**

Catalog Number	Description	Price Each
<b>B160V</b>	C&R Mold Clamps for Vertical Pipe - VS, VF, VB and VV	200.27

### ONE SHOT CABLE TO GROUND ROD

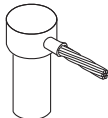

Vendor Code: **CDW**

Catalog Number	Wire Size	Ctn. Qty.	Price Each
<b>FLINT IGNITOR POLE</b>			
<b>GR1161G</b>	8 - 6	6	13.22
<b>GR1161V</b>	1-2	6	14.28
<b>ELECTRONIC IGNITOR PLUS CU</b>			
<b>GR1161GPLUS</b>	8 - 6	6	13.50
<b>GR1161VPLUS</b>	1 - 2	6	14.89

Disposable Mold and Shot

### PARALLEL HORIZONTAL CONDUCTORS MOLD

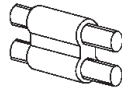

Vendor Code: **CDW**

Catalog Number	Cable Run	Size Tap	Req'd. Shot	Ctn. Qty.	Price Each
<b>PTC1T1T</b>	2 Sol	2 Sol	#65	1	168.52

Clamps are Included with Mold

### WELD METAL COPPER TO COPPER & COPPER TO STEEL



STANDARD

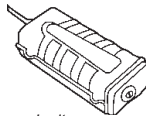

Ignitor



CADWELD PLUS

Vendor Code: **CDW**

Catalog Number	Description	Ctn. Qty.	Price Each
<b>25</b>	#25 Shot	20	3.61
<b>32</b>	#32 Shot	20	4.47
<b>45</b>	#45 Shot	20	6.13
<b>65</b>	#65 Shot	20	7.64
<b>90</b>	#90 Shot	10	10.63
<b>115</b>	#115 Shot	10	13.28
<b>150</b>	#150 Shot	10	17.15
<b>200</b>	#200 Shot	10	20.37
<b>250</b>	#250 Shot	10	28.39

#### CADWELD PLUS SYSTEM

<b>25PLUSF20</b>	#25 Shot Plus	20	3.61
<b>32PLUSF20</b>	#32 Shot Plus	20	4.56
<b>45PLUSF20*</b>	#45 Shot Plus	20	6.14
<b>65PLUSF20*</b>	#65 Shot Plus	20	7.67
<b>90PLUSF20*</b>	#90 Shot Plus	10	10.37
<b>115PLUSF20</b>	#115 Shot Plus	10	13.30
<b>150PLUSF20</b>	#150 Shot Plus	10	17.15
<b>200PLUSF20</b>	#200 Shot Plus	10	24.42
<b>250PLUSF20</b>	#250 Shot Plus	10	28.38
<b>PLUSCU</b>	Electronic Ignitor	1	187.38
<b>PLUSCULDQC</b>	Replacement Lead	1	53.12

\*Electronic Ignitor Required



### HORIZONTAL STEEL SURFACE MOLD

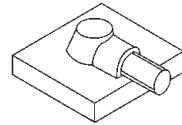

Vendor Code: **CDW**

Catalog Number	Cable Size	Req'd. Shot	Price Each
<b>HAA1T</b>	2 Sol	#45	102.68

Clamps are Included with Mold

### VERTICAL STEEL SURFACE MOLD

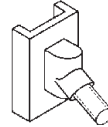

Vendor Code: **CDW**

Catalog Number	Cable Size	Req'd. Shot	Price Each
<b>VSC1T</b>	2 Sol	#45	168.52

Use L160 Handle Clamps

### VERTICAL PIPE MOLD

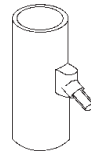

Vendor Code: **CDW**

Catalog Number	Cable Size	Pipe Size	Req'd. Shot	Price Each
<b>VSC1TV3C</b>	2 Sol	1-1/2" - 4"	#45	168.52

Use L160 or B160V Handle Clamps

### ACCESSORIES

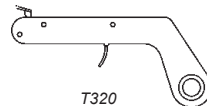

T320

Vendor Code: **CDW**

Catalog Number	Description	Price Each
<b>T320</b>	Flint Ignitor	11.29
<b>T394</b>	Narrow Mold Cleaning Brush	9.17
<b>T314</b>	Cable Cleaning Brush	79.27

A

Distribution Equipment



**A**

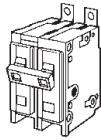

Branch Breakers  
120 - 240V 10 KAIC  
BAB

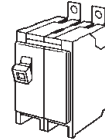
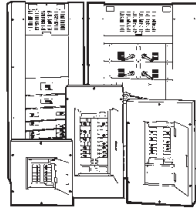

Branch Breakers  
277 - 480V 14 KAIC  
GHB

Complete Panelboard Price = Interior + Box + Trim + Main Lug Kit + Branch Breakers + Options  
Interiors Include a Ground Bar. Type of Bus: **A** = Aluminum, **C** = Copper

**INTERIORS**

Vendor Code: **CHS**

Catalog Number	Amps	Max Poles	Bus Type	Price Each
<b>120/240V, 1 PHASE</b>				
PRL1A1100X18A	100	18	A	85.99
PRL1A1100X18C	100	18	C	149.39
PRL1A1100X30A	100	30	A	107.10
PRL1A1100X30C	100	30	C	183.70
PRL1A1225X30A	225	30	A	117.60
PRL1A1225X30C	225	30	C	202.83
PRL1A1225X42A	225	42	A	149.43
PRL1A1225X42C	225	42	C	213.29
PRL1A1400X42A	400	42	A	171.38
PRL1A1400X42C	400	42	C	240.41
<b>120/208V, 3 PHASE</b>				
PRL1A3100X18A	100	18	A	105.30
PRL1A3100X18C	100	18	C	171.25
PRL1A3100X30A	100	30	A	128.53
PRL1A3100X30C	100	30	C	197.73
PRL1A3225X30A	225	30	A	137.75
PRL1A3225X30C	225	30	C	207.00
PRL1A3225X42A	225	42	A	163.19
PRL1A3225X42C	225	42	C	232.61
PRL1A3400X42A	400	42	A	213.48
PRL1A3400X42C	400	42	C	293.17
<b>277/480V, 3 PHASE</b>				
PRL2A3100X18A	100	18	A	107.20
PRL2A3100X18C	100	18	C	176.37
PRL2A3100X30A	100	30	A	133.65
PRL2A3100X30C	100	30	C	202.84
PRL2A3225X30A	225	30	A	144.09
PRL2A3225X30C	225	30	C	213.29
PRL2A3225X42A	225	42	A	170.55
PRL2A3225X42C	225	42	C	240.25
PRL2A3400X42A	400	42	A	213.39
PRL2A3400X42C	400	42	C	293.13

**ACCESSORIES**

Vendor Code: **CHS**

Catalog Number	Description	Price Each
SEK12	Service Entrance Kit	12.29
SEK46	Service Entrance Kit	12.29
2NK225	200% Neutral Kit	80.19
ISDGROUND	Isolated Ground Bar	41.74
2NK100	Neutral Kit	37.47



**BOX & TRIM**

Vendor Code: **CHS**

Catalog Number	Description	Price Each
<b>20" X 36"</b>		
EZB2036RBS	100A 18 Cir NEMA 1 Can	18.45
EZT2036S	100A 18 Cir Surface Trim	57.32
EZT2036F	100A 18 Cir Flush Trim	57.32
<b>20" X 48"</b>		
EZB2048RBS	225A 30 Cir NEMA 1 Can	12.54
EZT2048S	225A 30 Cir Surface Trim	70.77
EZT2048F	225A 30 Cir Flush Trim	70.77
<b>20" X 60"</b>		
EZB2060RBS	400A 42 Cir NEMA 1 Can	16.29
EZT2060S	400A 42 Cir Surface Trim	87.92
EZT2060F	400A 42 Cir Flush Trim	87.92
<b>20" X 72"</b>		
EZB2072RBS	400A 42 Cir NEMA 1 Can	16.29
EZT2072S	400A 42 Cir Surface Trim	293.00
EZT2072F	400A 42 Cir Flush Trim	139.01
<b>NEMA 3R CANS</b>		
GWPBQ2036PR	100A 18 Cir NEMA 3R Can	282.66
GWPBQ2048PR	225A 30 Cir NEMA 3R Can	351.70
GWPBQ2060PR	225A 42 Cir NEMA 3R Can	404.82
GWPBQ2072PR	400A 42 Cir NEMA 3R Can	447.21

**LUG KITS  
MAIN OR SUBFEED**

Vendor Code: **CHS**

Catalog Number	Description	Price Each
LUGKIT100	100 Amp Lug Kit	30.24
LUGKIT225	225 Amp Lug Kit	38.18
LUGKIT400	400 Amp Lug Kit	56.98

**BREAKER KITS  
MAIN OR SUBFEED**

Vendor Code: **CHS**

Catalog Number	Description	Price Each
BKED100T	100 Amp Top Feed	277.46
BKED125T	125 Amp Top Feed	389.09
BKED150T	150 Amp Top Feed	389.09
BKED200T	200 Amp Top Feed	389.09
BKED225T	225 Amp Top Feed	389.09
BKED100B	100 Amp Bottom Feed	277.46
BKED125B	125 Amp Bottom Feed	389.09
BKED200B	200 Amp Bottom Feed	389.09
BKED225B	225 Amp Bottom Feed	389.09
BKFD100T	100 Amp Top Feed	330.63
BKFD125T	125 Amp Top Feed	511.55
BKFD150T	150 Amp Top Feed	511.55
BKFD200T	200 Amp Top Feed	511.55

**BRANCH BREAKERS  
120 - 240V 10K AIC**

Vendor Code: **ETN**

Catalog Number	Amps	Price Each
<b>SINGLE POLE 120/240 VOLT</b>		
BAB1015	15	30.67
BAB1020	20	30.67
BAB1030	30	30.84
BAB1040	40	34.85
BAB1050	50	34.85
<b>SINGLE POLE GROUND FAULT</b>		
QBGFT1015	15	266.23
QBGFT1020	20	376.13

Vendor Code: **ETN**

Amps	2 Pole	Price Each	3 Pole	Price Each
<b>120/240 VOLT</b>				
15	BAB2015	71.33	BAB3015H	252.56
20	BAB2020	71.33	BAB3020H	252.56
30	BAB2030	71.33	BAB3030H	252.56
40	BAB2040	71.33	BAB3040H	252.56
50	BAB2050	82.31	BAB3050H	263.55
60	BAB2060	93.27	BAB3060H	262.69
70	BAB2070	165.05	BAB3070H	274.03
90	BAB2090	175.47	BAB3090H	287.96
100	BAB2100	186.44	BAB3100H	317.74

**BRANCH BREAKERS  
277 - 480V 14 KAIC**

Vendor Code: **ETN**

Catalog Number	Amps	Price Each
<b>SINGLE POLE 277 VOLT</b>		
GHB1015	15	129.99
GHB1020	20	129.99
GHB1030	30	129.99

Vendor Code: **ETN**

Amps	2 Pole	Price Each	3 Pole	Price Each
<b>277/480 VOLT</b>				
15	GHB2015	249.99	GHB3015	537.98
20	GHB2020	249.99	GHB3020	537.98
30	GHB2030	249.99	GHB3030	274.42
40	GHB2040	249.99	GHB3040	537.98
50	GHB2050	279.99	GHB3050	537.98
60	GHB2060	279.99	GHB3060	537.98
70	GHB2070	399.99	GHB3070	737.04
90	GHB2090	399.99	GHB3090	378.43
100	GHB2100	399.99	GHB3100	737.04



## Molded Case Circuit Breakers – Series C

### F-FRAME

Non-interchangeable trip unit  
load terminals included

#### TYPE ED

240V AC MAX, 125V DC  
65 KAIC @ 240V AC

Vendor Code: **ETN**

Catalog Number	Description	Price Each
<b>SINGLE PHASE</b>		
<b>ED2200L</b>	2 Pole, 200 Amp, Line & Load Lugs	623.08
<b>THREE PHASE</b>		
<b>ED3100</b>	3 Pole, 100 Amp	623.08
<b>ED3125</b>	3 Pole, 125 Amp	623.08
<b>ED3200</b>	3 Pole, 200 Amp	623.08
<b>ED3225</b>	3 Pole, 225 Amp	623.08

#### TYPE EHD

480V AC MAX, 250V DC  
14 KAIC @ 480V AC

Vendor Code: **ETN**

Catalog Number	Description	Price Each
<b>THREE PHASE</b>		
<b>EHD3020</b>	3 Pole, 20 Amp	369.99
<b>EHD3030</b>	3 Pole, 30 Amp	379.99
<b>EHD3060</b>	3 Pole, 60 Amp	389.99
<b>EHD3100</b>	3 Pole, 100 Amp	459.99

#### TYPE FD

600V AC MAX, 250V DC  
35 KAIC @ 480V AC

Vendor Code: **ETN**

Catalog Number	Description	Price Each
<b>SINGLE PHASE</b>		
<b>FD1020</b>	1 Pole, 20 Amp	222.58
<b>FD1030</b>	1 Pole, 30 Amp	222.58
<b>FD2020</b>	2 Pole, 20 Amp	515.38
<b>FD2030</b>	2 Pole, 30 Amp	515.38
<b>FD2060</b>	2 Pole, 60 Amp	515.38
<b>FD2100</b>	2 Pole, 100 Amp	595.38
<b>THREE PHASE</b>		
<b>FD3020</b>	3 Pole, 20 Amp	699.99
<b>FD3030</b>	3 Pole, 30 Amp	709.99
<b>FD3060</b>	3 Pole, 60 Amp	719.99
<b>FD3100</b>	3 Pole, 100 Amp	799.99

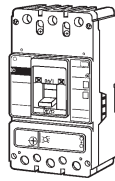

**TYPE HFD**  
600V AC MAX, 250V DC  
65 KAIC @ 480V AC

Vendor Code: **ETN**

Catalog Number	Description	Price Each
<b>SINGLE PHASE</b>		
<b>HFD1020</b>	1 Pole, 20 Amp	258.46
<b>HFD1030</b>	1 Pole, 30 Amp	258.46
<b>HFD2015</b>	2 Pole, 15 Amp	607.69
<b>HFD2020</b>	2 Pole, 20 Amp	607.69
<b>HFD2030</b>	2 Pole, 30 Amp	607.69
<b>HFD2100</b>	2 Pole, 100 Amp	846.15
<b>HFD2225</b>	2 Pole, 225 Amp	3057.14
<b>THREE PHASE</b>		
<b>HFD3015</b>	3 Pole, 15 Amp	792.31
<b>HFD3020</b>	3 Pole, 20 Amp	792.31
<b>HFD3030</b>	3 Pole, 30 Amp	792.31
<b>HFD3040</b>	3 Pole, 40 Amp	792.31
<b>HFD3050</b>	3 Pole, 50 Amp	792.31
<b>HFD3060</b>	3 Pole, 60 Amp	792.31
<b>HFD3100</b>	3 Pole, 100 Amp	1199.99
<b>HFD3225</b>	3 Pole, 225 Amp	3795.41

### LINE TERMINALS

Vendor Code: **ETN**

Catalog Number	Description	Price Each
<b>STANDARD BOLTED PRESSURE</b>		
<b>3T100FB*</b>	14-1/0 AWG 100 Amp	94.99
<b>3TA225FD*</b>	4-4/0 AWG 225 Amp	134.99

\*Includes Three Terminals

### J-FRAME

Interchangeable trip unit  
Line & load terminals included  
Adjustable magnetic trip 5-10x  
continuous amp rating

#### TYPE JD

600V AC, 35 KAIC @ 480V AC

Vendor Code: **ETN**

Catalog Number	Description	Price Each
<b>THREE PHASE</b>		
<b>JD3175</b>	3 Pole, 175 Amp	2691.15
<b>JD3225</b>	3 Pole, 225 Amp	2699.99
<b>JD3250</b>	3 Pole, 250 Amp	2999.99

### LINE OR LOAD TERMINALS

Vendor Code: **ETN**

Catalog Number	Description	Price Each
<b>STANDARD PRESSURE</b>		
<b>TA250KB</b>	(1) 4-350kcmil 250 Amp	36.99

( ) Indicates Number of Cables per Terminal

### K-FRAME

Non-interchangeable trip unit  
Line & load terminals included

#### TYPE DK

240V AC, 240V DC, 65 KAIC @ 240V AC

Vendor Code: **ETN**

Catalog Number	Description	Price Each
<b>THREE PHASE</b>		
<b>DK3250</b>	3 Pole, 250 Amp	501.76
<b>DK3400</b>	3 Pole, 400 Amp	3299.99

### LINE OR LOAD TERMINALS

Vendor Code: **ETN**

Catalog Number	Description	Price Each
<b>STANDARD PRESSURE LUGS</b>		
<b>TA300K*</b>	(1) 3-350AWG 225 Amp	29.99
<b>TA350K*</b>	(1) 250-500AWG 350 Amp	31.99
<b>COMPRESSION TERMINALS KITS</b>		
<b>3TA401K**</b>	(2) 2/0-250AWG 400 Amp	95.46
<b>3TA402K**</b>	(1) 500-750AWG 400 Amp	97.99

( ) Indicates Number of Cables per Terminal  
\*Kit Includes Required Terminals and Terminal Cover  
\*\*One Lug per Pack.

### L-FRAME

Interchangeable trip unit  
Line & load terminals included

#### TYPE LD

600V AC, 35 KAIC @ 480V AC

Vendor Code: **ETN**

Catalog Number	Description	Price Each
<b>SINGLE PHASE</b>		
<b>LD2600</b>	2 Pole, 600 Amp	6599.99
<b>THREE PHASE</b>		
<b>LD3600</b>	3 Pole, 600 Amp	4892.16

#### TYPE HLD

600V AC, 65 KAIC @ 480V AC

Vendor Code: **ETN**

Catalog Number	Description	Price Each
<b>THREE PHASE</b>		
<b>HLD3600</b>	3 Pole, 600 Amp	6499.99

### LINE OR LOAD TERMINALS

Vendor Code: **ETN**

Catalog Number	Description	Price Each
<b>STANDARD BOLTED TERMINALS</b>		
<b>3TA401LDK*</b>	(1) 4/0-600AWG 400A	124.99
<b>TA602LD**</b>	(2) 3/0-350AWG 500A Lug	48.99
<b>3TA603LDK*</b>	(2) 400-500AWG 600A	155.99
<b>COMPRESSION TERMINALS</b>		
<b>T602LD**</b>	(2) 250-350AWG 600A Lug	51.03

( ) Indicates Number of Cables per Terminal  
\*3 Pole Kit Includes Required Terminals and Terminal Cover  
\*\*Individually Packed

Distribution Equipment



**A**

**Distribution Equipment**

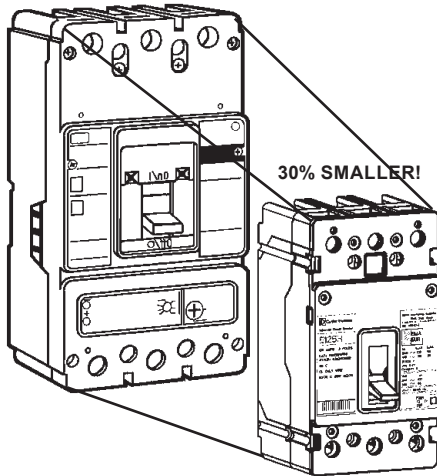

With Eaton Series G Molded Cases Circuit Breaker (MCCB), the G stands for "Global". For OEMs serving global markets, the Series G is the only molded case breaker globally marked with UL, CSA, CE, IEC and Kema Keur certification.

**The Series G MCCB Features:**

**Space Savings**

- 30% Smaller Size
- Only five frames needed to cover all current ranges
- Solid State trip allows applications at 100% Rating

**OEM-Friendly, World Class Accessories**

- Plug-in Blocks
- Flexible shaft and rotary handle mechanisms
- Multiple conductor lugs
- Finger-proof shields
- Electrical Operators
- Multiple wire connectors

**Faster Startup...Less Downtime**

- Field-Fit Accessories on all frames
- UL rated, 30mA Earth leakage modules
- Built-in ground fault protection down to 20 amperes
- Only MCCB with third-party witness and follow-up certification
- Electronic trip units and ground fault modules reduce risk of equipment failure

**EG-FRAME**

**125A FRAME**  
**25KA @ 240V AC**  
**18KA @ 480V AC**  
**3"W X 5.5"H X 2.99"D**

Vendor Code: **ETN**

Catalog Number	Description	Price Each
<b>THREE PHASE</b>		
<b>EGB3015FFG</b>	15 Amp	538.46
<b>EGB3020FFG</b>	20 Amp	501.76
<b>EGB3050FFG</b>	50 Amp	538.46
<b>EGB3060FFG</b>	60 Amp	538.46
<b>EGB3100FFG</b>	100 Amp	666.78
<b>EGB3125FFG</b>	125 Amp	1041.15

High Interrupting Capacity Also Available.

**LG-FRAME**

**600A FRAME**  
**65KA@240VAC**  
**35KA@480VAC**  
**5.48"W X 10.13"H X 4.09"D**

Vendor Code: **ETN**

Catalog Number	Description	Price Each
<b>LGE3250FAG</b>	250 Amp	4508.16
<b>LGE3300FAG</b>	300 Amp	2582.80
<b>LGE3350FAG</b>	350 Amp	2582.80
<b>LGE3400FAG</b>	400 Amp	3475.04
<b>LGE3500FAG</b>	500 Amp	3709.75
<b>LGE3600FAG</b>	600 Amp	9982.60

High Interrupting Capacity Also Available.

**JG-FRAME**

**250A FRAME**  
**65KA @ 240V AC**  
**25KA @ 480V AC**  
**4.125"W X 7"H X 3.57"D**

Vendor Code: **ETN**

Catalog Number	Description	Price Each
<b>THREE PHASE</b>		
<b>JGE3200FAG</b>	200 Amp 35KA	826.48
<b>JGE3250FAG</b>	250 Amp 35KA	1805.83
<b>THREE PHASE - HIGH INTERRUPTING CAPACITY</b>		
<b>JGH3200FAG</b>	200 Amp 65KA	3843.80
<b>JGH3250FAG</b>	250 Amp 65KA	3995.35

High Interrupting Capacity Also Available.

**NG-FRAME**

**1200A FRAME**  
**100KA@240V**  
**65KA@480V**  
**8.25"W X 16"H X 5.5"D**

Vendor Code: **ETN**

Catalog Number	Description	Price Each
<b>NGH308033E</b>	800 Amp	15196.80
<b>NGH312033E</b>	1,200 Amp	24974.40
<b>NGH316033E</b>	1,600 Amp	13719.20

High Interrupting Capacity Also Available.

**MCP BREAKERS**

**FOR USE WITH STARTERS**  
**ADJUSTABLE MAGNETIC TRIP**

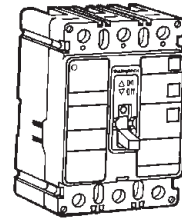

Vendor Code: **ETN**

Catalog Number	Cont Amps	Trip Setting	Starter Size	Price Each
<b>HMCP015E0C</b>	15	45-150	0	746.03
<b>HMCP030H1</b>	30	90-300	1	794.60
<b>HMCP050K2C</b>	50	150-500	2	985.26
<b>HMCP100R3</b>	100	300-1000	3	1114.98
<b>HMCP150T4</b>	150	400-1500	4	1608.92







### FRAME 1 – 125A FRAME

Vendor Code: **ETN**

Catalog Number	Description
<b>18KA @ 480VAC, 480VAC MAX</b>	
PDG13C0015TFFJ	3 Pole, 15 Amps
PDG13C0020TFFJ	3 Pole, 15 Amps
PDG13C0050TFFJ	3 Pole, 15 Amps
PDG13C0060TFFJ	3 Pole, 15 Amps
PDG13C0100TFFJ	3 Pole, 15 Amps
PDG13C0125TFFJ	3 Pole, 15 Amps

Non-Interchangeable Trip Unit Load Terminals Included  
3.00 W x 5.50 H x 2.99 D inches

### FRAME 2 – 225A FRAME

Vendor Code: **ETN**

Catalog Number	Description
<b>25KA @ 480VAC, 480VAC MAX</b>	
PDG23F0020TFFL	3 Pole, 20 Amp
PDG23F0030TFFL	3 Pole, 30 Amp
PDG23F0060TFFL	3 Pole, 60 Amp
PDG23F0100TFFL	3 Pole, 100 Amp
<b>35KA @ 480VAC, 480VAC MAX</b>	
PDG21G0020TFFL	1 Pole, 20 Amp
PDG21G0030TFFL	1 Pole, 30 Amp
PDG22G0020TFFL	2 Pole, 20 Amp
PDG22G0060TFFL	2 Pole, 60 Amp
PDG22G0100TFFL	2 Pole, 100 Amp
PDG23G0020TFFL	3 Pole, 20 Amp
PDG23G0030TFFL	3 Pole, 30 Amp
PDG23G0060TFFL	3 Pole, 60 Amp
PDG23G0100TFFL	3 Pole, 100 Amp
PDG23G0175TFFJ	3 Pole, 175 Amp
PDG23G0225TFFJ	3 Pole, 225 Amp
<b>65KA @ 240VAC, 240VAC MAX</b>	
PDD22G0200TFFJ	2 Pole, 200 Amp
PDD23G0100TFFL	3 Pole, 100 Amp
PDD23G0125TFFL	3 Pole, 125 Amp
PDD23G0200TFFL	3 Pole, 200 Amp
PDD23G0225TFFL	3 Pole, 225 Amp
<b>65KA @ 480VAC, 480VAC MAX</b>	
PDG21M0020TFFL	1 Pole, 20 Amp
PDG21M0030TFFL	1 Pole, 30 Amp
PDG22M0015TFFL	2 Pole, 15 Amp
PDG22M0020TFFL	2 Pole, 20 Amp
PDG22M0030TFFL	2 Pole, 30 Amp
PDG22M0100TFFL	2 Pole, 100 Amp
PDG22M0225TFFL	2 Pole, 225 Amp
PDG23M0015TFFL	3 Pole, 15 Amp
PDG23M0020TFFL	3 Pole, 20 Amp
PDG23M0030TFFL	3 Pole, 30 Amp
PDG23M0040TFFL	3 Pole, 40 Amp
PDG23M0050TFFL	3 Pole, 50 Amp
PDG23M0060TFFL	3 Pole, 60 Amp
PDG23M0100TFFL	3 Pole, 100 Amp
PDG23M0225TFFL	3 Pole, 225 Amp

Interchangeable Trip Unit Load Terminals Included  
4.13 W x 6.00 H x 3.38 D inches



### NEW PRODUCT

## Power Defense



A globally rated platform from Eaton.

### Consistent Catalog Numbering Across all Six Frames

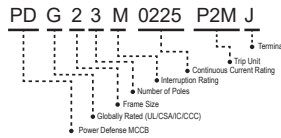

### FRAME 2 TERMINALS FRAME 2 – 225A FRAME

Vendor Code: **ETN**

Catalog Number	Description
PDG2X3T100	(1) 15-100, 100 A
+	(1) 60-225, 225 A

### FRAME 3 – 600A FRAME

Vendor Code: **ETN**

Catalog Number	Description
<b>25KA @ 480VAC, 480VAC MAX</b>	
PDG33F0200TFAJ	3 Pole, 200 Amp
PDG33F0250TFAJ	3 Pole, 250 Amp
PDG33F0300TFAJ	3 Pole, 300 Amp
PDG33F0350TFAJ	3 Pole, 350 Amp
PDG33F0400TFAJ	3 Pole, 400 Amp
PDG33F0500TFAJ	3 Pole, 500 Amp
PDG33F0600TFAJ	3 Pole, 600 Amp
<b>35KA @ 480VAC, 480VAC MAX</b>	
PDG32G0600TFAJ	2 Pole, 600 Amp
PDG33G0250TFAJ	3 Pole, 250 Amp
PDG33G0600TFAJ	3 Pole, 600 Amp
<b>65KA @ 480VAC, 480VAC MAX</b>	
PDG33M0200TFAJ	3 Pole, 200 Amp
PDG33M0250TFAJ	3 Pole, 250 Amp
PDG33M0600TFAJ	3 Pole, 600 Amp
<b>35KA @ 480VAC, 480VAC MAX</b>	
PDF33G0250TFAJ	3 Pole, 250 Amp
<b>65KA @ 240VAC, 240VAC MAX</b>	
PDD33G0250TFAJ	3 Pole, 250 Amp
PDD33G0400TFAJ	3 Pole, 400 Amp

Interchangeable Trip Unit Load Terminals Included  
5.48 W x 10.13 H x 4.09 D inches

Eaton's Power Defense line of Molded Case Circuit breakers (MCCB) are globally rated for use in UL, CS, CE, and IEC markets.

#### Power Defense MCCB Features:

- Cover all current ranges across 6 frame sizes
- Fast & easy installation on through-cover accessories on Frames 1-4
- Interchangeable trip units on Frames 3-6
- Consistent mounting and lug options with Series C & G
- Serialized QR code laser etched into every breaker

### FRAME 3 TERMINALS FRAME 3 – 600A FRAME

Vendor Code: **ETN**

Catalog Number	Description
PDG3X3TA300	(1) 3-350, 300A
PDG3X3TA350	(1) 250-500, 350A
PDG3X3TA401	(1) 0-500, 400 A or (2) 0-250, 400 A
PDG3X3TA402	(1) 500-700, 400 A

### FRAME 5 – 1200A FRAME

Vendor Code: **ETN**

Catalog Number	Description
<b>35KA @ 480VAC, 480VAC MAX</b>	
PDF53M1200E2NN	3 Pole, 1200 Amp
<b>65KA @ 480VAC, 480VAC MAX</b>	
PDG53M0800E2NN	3 Pole, 800 Amp

Interchangeable Trip Unit Load Terminals Included  
8.25 W x 16.00 H x 5.50 D inches

**Ask Your Local  
Elliott Electric Supply  
Sales Representative for  
Power Defense Product  
Pricing Information!**

**A  
Distribution Equipment**



Power Xpert Release (PXR) Electronic Trip Units Features

Distribution Equipment

Power Xpert Release (PXR) Electronic Trip Units

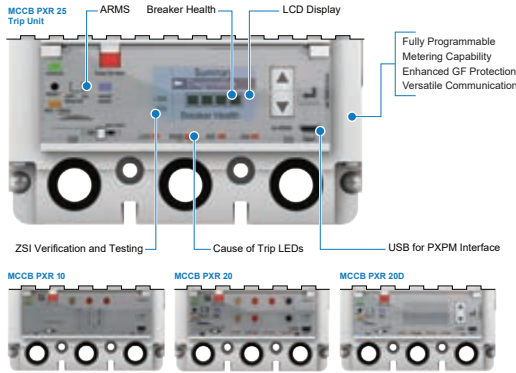

Features of PXR Trip Units	PXR 10	PXR 20	PXR 20D	PXR 25
Protection types	LSI	LSI/LSIG	LSI/LSIG	LSI/LSIG
Status indication	•	•	•	•
USB secondary injection testing	•	•	•	•
Programmable by USB port (PXPIM)	•	•	•	•
Independent instantaneous adjustment	•	•	•	•
Adjustable L, S, I, G pickup and time	•	•	•	•
Cause of trip indication	▲	•	•	•
Load alarm indication with 2 levels		•	•	•
Programmable load alarm levels		•	•	•
Ground fault protection and alarm		o	o	o
Arcflash Reduction Maintenance System (ARMS)		o	o	o
Zone selective interlocking (ZSI) with indication		o	o	o
Programmable relays		o	•	•
Modbus RTU communication		o	•	•
CAM module communication		o	o	o
Rotatable LCD display			•	•
Breaker health and diagnostic monitoring		▲	•	•
Voltage metering accurate to .5%				•
Power and energy metering accurate to 1%				•

• = Standard, o = Optional, ▲ = Available through USB port (PXPIM)

Breaker Health

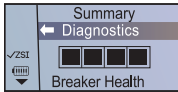

- Monitors and communicates breaker health status, enabling predictive maintenance to avoid costly, unscheduled downtime

Enhanced Ground Fault Protection

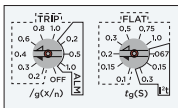

- Combined functionality to trip and/or alarm, including a pre-alarm option via a programmable relay, provides maximum protection options and system uptime

Cause of Trip LEDs



- Cause of trip indication provides insights into a trip event, increasing worker safety and efficiency while troubleshooting

LCD Display with Programmable Settings



- Local availability to fully programmable settings, breaker diagnostics, visual customization, event records, injection testing and unit information

Zone Selective Interlocking (ZSI)



- Designed to reduce thermal and mechanical stress on distribution equipment and arc flash incident energy released during phase or ground faults by enabling the breaker closest to the fault to override customer-defined delay settings while communicating with upstream and downstream breakers

Metering Capability

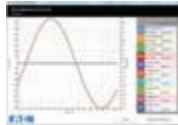

- Current and voltage metering accurate to 0.5% of reading; power and energy metering accurate to 1% of reading
- Voltage metering internal to trip unit with no need for external modules

Power Xpert Protection Manager (PXPIM) software



- PXR trip units equipped with micro-USB connection for secondary injection testing through your PC, saving you labor hours and the cost of expensive test kits

Arcflash Reduction Maintenance System™ (ARMS)



- Industry-leading solution to reduce arc flash energy released during maintenance operations using a separate circuit to provide faster than instantaneous clearing times

Versatile Communications Options



- Imbedded Modbus RTU
- Additional communications protocols, including Modbus TCP, webpage interface and PROFIBUS, available via Eaton's Communications Adapter Modules (CAM)
- CAM module relays that can be programmed for custom breaker and trip unit visibility

Programmable Relays



- Multiple programmable relays provide user customizable visibility into breaker and trip unit, such as status, trip events, alarms, and indication of ZSI, ARMS or breaker health



### 250V GENERAL DUTY SWITCHES

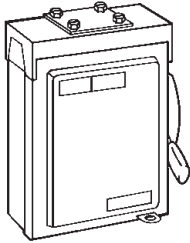

- New design on 30A switches.
- Quick Make/ Quick Break.

Vendor Code: **CHD**

Catalog Number	Description	Price Each
<b>INDOOR FUSIBLE 2P 3W (S/N) FUSIBLE 120/240V</b>		
DG221NGB	30A Cart.Fuse	62.04
DG222NGB	60A Cart.Fuse	80.82
DG223NGB	100A Cart.Fuse	164.74
DG224NGK	200A Cart.Fuse	318.76
DG225NGK	400A Cart.Fuse	955.38
<b>3P 4W (S/N) FUSIBLE 120/208/240V</b>		
DG321NGB	30A Cart.Fuse	80.00
DG322NGB	60A Cart.Fuse	127.61
DG323NGB	100A Cart.Fuse	212.68
DG324NGK	200A Cart.Fuse	462.09
DG325NGK	400A Cart.Fuse	1061.59
DG326NGK	600A Cart.Fuse	6864.91
<b>RAINTIGHT FUSIBLE 2P 3W (S/N) 2 FUSIBLE 120/240V</b>		
DG221NRB	30A Cart.Fuse	91.66
DG222NRB	60A Cart.Fuse	150.90
DG223NRB	100A Cart.Fuse	184.03
DG224NRK	200A Cart.Fuse	456.65
DG225NRK	400A Cart.Fuse	1414.25
<b>3P 4W (S/N) 3 FUSIBLE 120/208/240V</b>		
DG321NRB	30A Cart.Fuse	117.16
DG322NRB	60A Cart.Fuse	175.49
DG323NRB	100A Cart.Fuse	318.56
DG324NRK	200A Cart.Fuse	573.35
DG325NRK	400A Cart.Fuse	1488.00
DG326NRK	600A Cart.Fuse	3078.04
<b>INDOOR NON-FUSIBLE 2P 2W 240V</b>		
DG221UGB	30A NF	59.07
DG222UGB	60A NF	76.88
<b>3P 3W 240V</b>		
DG321UGB	30A NF	69.37
DG322UGB	60A NF	80.85
DG323UGB	100A NF	186.15
DG324UGK	200A NF	340.07
DG325UGK	400A NF	796.19
<b>RAINTIGHT NON-FUSIBLE 2P 2W 240V</b>		
DG221URB	30A NF	80.15
DG222URB	60A NF	133.06
<b>3P 3W 240V</b>		
DG321URB	30A NF	115.10
DG322URB	60A NF	175.49
DG323URB	100A NF	311.70
DG324URK	200A NF	562.71
DG325URK	400A NF	1337.63

### 600V HEAVY DUTY SWITCHES K-SERIES DESIGN

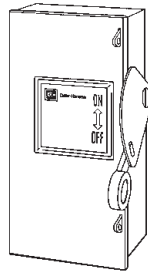

- High visibility handle & nameplate
- Generous wiring room
- Built-in fuse pullers
- See-through line shields
- Side hinged NEMA Type 3R doors on all sides
- Available in NEMA Types 4, 4X & 12

Vendor Code: **CHD**

Catalog Number	MAX HP 480V	Description	Price Each
<b>INDOOR FUSIBLE 3P 3W 600V</b>			
DH361FGK	15	30A Cart.Fuse	209.36
DH362FGK	30	60A Cart.Fuse	253.10
DH363FGK	60	100A Cart.Fuse	493.42
DH364FGK	125	200A Cart.Fuse	675.50
DH365FGK	250	400A Cart.Fuse	1791.51
<b>RAINTIGHT FUSIBLE 3P 3W 600V</b>			
DH361FRK	15	30A Cart.Fuse	370.08
DH362FRK	30	60A Cart.Fuse	439.59
DH363FRK	60	100A Cart.Fuse	643.36
DH364FRK	125	200A Cart.Fuse	911.04
DH365FRK	250	400A Cart.Fuse	2142.66
DH366FRK	400	600A Cart. Fuse	4224.11
<b>INDOOR NON-FUSIBLE 3P 3W 600V</b>			
DH361UGK	20	30A NF	118.50
DH362UGK	50	60A NF	198.79
DH363UGK	75	100A NF	327.11
DH364UGK	125	200A NF	493.30
<b>RAINTIGHT NON-FUSIBLE 3P 3W 600V</b>			
DH361URK	20	30A NF	193.42
DH362URK	50	60A NF	364.70
DH363URK	75	100A NF	509.20
DH364URK	125	200A NF	589.84

### NEMA 3R DOUBLE THROW MANUAL TRANSFER SWITCHES

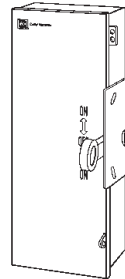

Vendor Code: **CHD**

Catalog Number	Description	Price Each
<b>120/240 SINGLE PHASE</b>		
DT223URKNPS	100 Amp	345.33
DT224URKNPS	200 Amp	849.43

### HUBS

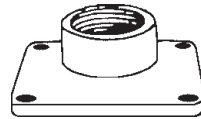

Vendor Code: **CHD**

Catalog Number	Description	Price Each
<b>SAFETY SWITCHES RATED 30 TO 100 AMPS</b>		
DS075H1	3/4"	16.21
DS100H1	1"	16.77
DS125H1	1-1/4"	17.33
DS150H1	1-1/2"	17.88
DS200H1	2"	17.92
<b>SAFETY SWITCHES RATED 200 AMPS</b>		
DS200H2	2"	25.92
DS250H2	2-1/2"	47.08
DS300H2	3"	43.90

Above 3" Use Meyers Hubs on Page E5

### NEUTRAL KITS

Vendor Code: **CHD**

Catalog Number	Description	Price Each
DH030NK	30-60A Neutral Bar	36.60
DH100NK	100A HD Neutral Bar	71.06
DG200NK	200A GD Neutral Bar	77.63
DH200NK	200A HD Neutral Bar	84.10
DS400NK	400A Neutral Bar	139.64
DS600NK	600A Neutral Bar	146.01



Other Sizes, Modifications and Accessories available upon request.



A

Distribution Equipment

**DRY-TYPE**

2007 ENERGY EFFICIENT  
COMPLIES WITH PER 10 CFR- PART  
431

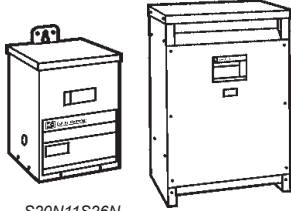

S20N11S26N

V48M28T1516  
or T20P11550EE

Vendor Code: **ETN**

Catalog Number	KVA	Weight LBS	Temp Rise	Price Each
<b>1 PHASE 240/480 - 120/240, NEMA 3R ENCAPSULATED, NO TAPS, WIRE LEADS</b>				
S20N11P26P	.25	13	115	106.28
S20N11P51P	.50	13	115	112.60
S20N11P76P	.75	20	115	148.74
S20N11P01P	1.0	30	115	180.96
S20N11P16P	1.5	40	115	212.38
S20N11P02P	2.0	40	115	270.87
S20N11S03N	3.0	65	115	339.79
S20N11S05N	5.0	113	115	498.90
S20N11S07N	7.5	123	115	668.99
S20N11S10N	10	193	115	785.65
S20N11S15N	15	216	115	976.49
S20N11S25N	25	375	115	1624.71
<b>3 PHASE 480A-120/208Y NEMA 2, INDOOR W/TAPS**, NO LUGS</b>				
V48M28T1516	15	152	150	1432.13
V48M28T3016	30	230	150	1700.35
V48M28T4516	45	310	150	2041.04
V48M28T7516	75	480	150	2886.73
V48M28T1216	112.5	600	150	4002.07
V48M28T2216	225	1,100	150	6697.26

\*Taps: +1 - 5%, -2 - 5% @240V Primary;  
+2 - 2.5%, -4 - 2.5% @480V Primary  
\*\*Taps: +2 - 2.5%, -4 - 2.5%  
(+) Reduces Output Voltage  
(-) Increases Output Voltage  
Type "V" & "T" Floor Mounted.  
Lugs: Page K28

**WEATHERSHIELD KITS FOR NEMA 2**

Vendor Code: **ETN**

Catalog Number	Description	Price Each
WS11	T Series 50KVA	17.56
WS16	T Series 75 & 100 KVA	17.56
WS31	V48 Series 15-45 KVA	35.18
WS33	V48 Series 50-112.5 KVA	46.90
WS34	V48 Series 225-1,000 KVA	164.01

**CONTROL**

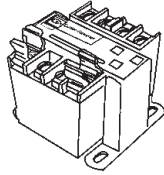

Vendor Code: **ETN**

Catalog Number	Primary Volts	Second Volts	Volt Amps	Price Each
C0050E1B	120/240V	24V	50VA	140.02
C0075E1B	120/240V	24V	75VA	150.15
C0100E1B	120/240V	24V	100VA	164.66
C0150E1B	120/240V	24V	150VA	206.28
C0200E1B	120/240V	24V	200VA	227.69
C0250E1B	120/240V	24V	250VA	227.75
C0300E1B	120/240V	24V	300VA	305.88
C0350E1B	120/240V	24V	350VA	281.54
C0500E1B	120/240V	24V	500VA	398.23
C0050E2A	240/480V	120V	50VA	164.86
C0075E2A	240/480V	120V	75VA	153.00
C0100E2A	240/480V	120V	100VA	168.00
C0150E2A	240/480V	120V	150VA	182.62
C0200E2A	240/480V	120V	200VA	240.94
C0250E2A	240/480V	120V	250VA	249.11
C0300E2A	240/480V	120V	300VA	241.13
C0350E2A	240/480V	120V	350VA	253.46
C0500E2A	240/480V	120V	500VA	344.99
C0750E2A	240/480V	120V	750VA	450.30
C1000E2A	240/480V	120V	1,000VA	640.13

Above Control Transformers Include Secondary Fuse Clips.  
Control Transformers Selection Procedure:  
Page L6

**PRIMARY FUSE KIT FOR CONTROL TRANSFORMERS**

Vendor Code: **ETN**

Catalog Number	Description	Price Each
PFK1	2-P CC Fuse	53.10

Fuses Not Included

Transformer Full Load Current  
on Page L7



**BUCK-BOOST**

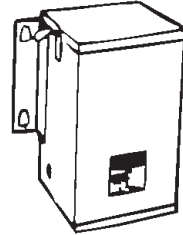

- Sand and Resin Encapsulated design
- Suitable for indoor and outdoor application
- Totally enclosed, non-ventilated enclosures
- Mountable in any position indoors and upright only outdoors
- 185°C Insulation System, 115°C rise standard

Vendor Code: **ETN**

Catalog Number	KVA	Weight Each	Price Each
<b>INPUT 120/240: OUTPUT 12/24</b>			
S10N04A81N	.05	6 lbs.	114.12
S10N04A82N	.10	6 lbs.	138.27
S10N04A83N	.15	10 lbs.	205.74
S10N04P26P	.25	13 lbs.	479.88
S10N04P51P	.50	13 lbs.	233.90
S10N04P76P	.75	20 lbs.	265.91
S10N04P01P	1.00	30 lbs.	318.76
S10N04P16P	1.50	40 lbs.	371.76
<b>INPUT 120/240: OUTPUT 16/32</b>			
S10N06A82N	.10	6 lbs.	127.63
S10N06A83N	.15	10 lbs.	148.98
S10N06P26P	.25	13 lbs.	201.94
S10N06P51P	.50	13 lbs.	223.26
S10N06P76P	.75	20 lbs.	276.55
S10N06P01P	1.00	30 lbs.	537.22
S10N06P16P	1.50	40 lbs.	582.35

Wiring Diagram and Selection: Page L7

**TRANSFORMER VIBRATION ISOLATION PADS**

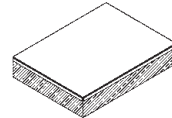

Vendor Code: **MOR**

Catalog Number	Description	Price Each
MP4C	4" x 4"	3.85



### PORTABLE GENERATORS 5 - 17.5KW

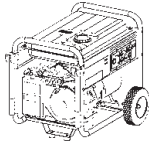

- Great for the jobsite or the home
- Low-tone muffler for quiet operation
- Up to ten hours of run time
- Low oil shutdown protects engine
- Two year limited warranty

Vendor Code: **GNR**

Catalog Number	Description	Price Each
<b>RECOIL START</b>		
5939	5.5kW, 120/240V	899.99
<b>ELECTRIC START</b>		
5735	17.5kW, 120/240V	5231.36

Generator Sizing Recommendations: Page L3

### AIR-COOLED GENERATORS 8 - 20KW

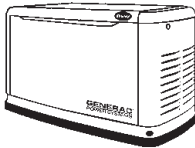

- Best-in-class power quality
- Streamline, aluminum enclosure
- Cleaner burning engine
- User friendly digital controls

Vendor Code: **GNR**

Catalog Number	kW	LPG/NG	Voltage	RPM	Price Each
<b>AIR-COOLED</b>					
7029	10/10kW	120/240V	3,600	2899.99	
7173	13/13kW	120/240V	3,600	3765.39	
7163	15/15 kW	120/240V	3,600	4993.16	
7176	16/16 kW	120/240V	3,600	4565.58	
7038	20/18 kW	120/240V	3,600	5121.67	
7042	22/19.5 kW	120/240V	3,600	5414.55	

Generator Sizing Recommendations: Page L3



Note: Generac available in select Elliott Electric Supply locations only.

### QT SERIES STANDBY GENERATORS 22 - 150KW

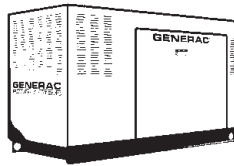

- Full automatic operation
- Corrosion resistant, sound attenuated enclosure
- Natural gas or LPG operation
- Advanced alternator design for clean electrical output

Vendor Code: **GNR**

Catalog Number	Description	Price Each
<b>120/240V, SINGLE PHASE</b>		
QT07068ANAX	70kW, Natural Gas	31199.22
QT08054ANAX	80kW, Natural Gas	22999.99
QT08054AVAX	80kW, LProVap	22999.99
QT10068ANAC	100kW, Natural Gas	30073.84
<b>120/208V, 3-PHASE</b>		
QT08054GNAX	80kW, Natural Gas	22999.99
QT10068GNAC	100kW, Natural Gas	41937.98

Available in a Variety of Configurations to Meet Your Specific Needs. Ask Your Elliott Electric Supply Sales Person for More Information.

### PANELS MANUAL TRANSFER AND GENERATOR

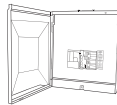

Manual Transfer

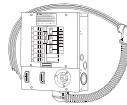

Generator

Eaton manual transfer switches allow you to connect a portable generator to your home. These panels use mechanically interlocked breakers to isolate selected critical circuits from the main panel and prevent paralleling of normal and emergency power. Manual transfer panels contain breakers only. Generator panels include breakers, integral plug-in generator connection (power inlet), and dual wattmeters for load balancing.

Vendor Code: **CHD**

Catalog Number	Gen. Watts	Max Poles/ Spaces	Price Each
<b>MANUAL TRANSFER PANELS</b>			
CH48GEN3060R*	5,000	4/8	242.50
CH816GEN6060**	15,000	8/16	279.96
<b>GENERATOR PANELS</b>			
CH10EGEN3060**	7,500	10	811.11
CH10EGEN3060R*	7,500	10	739.43

\*Raintight Enclosure  
\*\*Indoor Enclosure

### AUTOMATIC TRANSFER SWITCHES

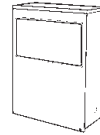

Vendor Code: **GNR** (Generac Power Systems Inc.)

Catalog Number	Description	Price Each
RXSC100A3	100A, 120/240V, N3R	379.99
RXSC200A3	200A, 120/240V, N3R	719.99
RXSW100A3	100A, 120/240V, N3R	619.99
RXSW150A3	150A, 120/240V, N3R	848.03
RXSW200A3	200A, 120/240V, N3R	848.03

Vendor Code: **CHD** (Eaton Corp.)

Catalog Number	Description	Price Each
EGSX100A	100A, 120/240V, N3R	428.57
EGSX200A*	200A, 120/240V, N3R	1029.59
EGSX200NSEA*	200A, 120/240V, N3R	959.00

\*Service Entrance Rated as Required by Certain Electric Utilities.

### “GREEN” AUTOMATIC TRANSFER SWITCHES WITH POWER SAVER CONTROL and Whole House Surge Protection

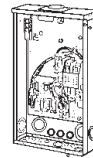

- Unique and most advanced active load management system to get the most out of your generator
- Actively manages the 2 largest loads preventing the generator from being overloaded while allowing other circuits to function
- Universal, works with any generator
- Whole house surge standard

Vendor Code: **CHD**

Catalog Number	Description	Price Each
<b>NON SE RATED</b>		
EGSU100ACA	100A Non SE Rated	1379.97
EGSU200ACA	200A Non SE Rated	1434.07
<b>SERVICE ENTRANCE RATED</b>		
EGSU100NSEACA	100A SE Rated	1228.90
EGSU200NSEACA	200A SE Rated	1712.06
EGSU400NSEACA	400A SE Rated	4013.85

Complete Unit, Includes Cover

Contact your local Elliott Electric Supply for special pricing on larger units.

A  
Distribution Equipment



Dual Element Time Delay · One-Time General Purpose · Fuse Reducers · Fuse Blocks

Distribution Equipment

**BUSSMANN FUSETRON  
DUAL ELEMENT TIME DELAY**  
CLASS RK5 1A-600A  
250/600V AC 200 KAIC

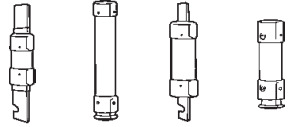

FRSR70 - FRSR1 - FRNR70 - FRNR1 - FRSR600 FRNR60 FRNR60

Vendor Code: **BUS**

Catalog Number	Amps	Carton Quantity	Price Each
<b>250V AC</b>			
FRNR1	1	10	13.68
FRNR5	5	10	12.99
FRNR10	10	10	10.95
FRNR15	15	10	8.80
FRNR20	20	10	8.98
FRNR25	25	10	9.39
FRNR30	30	10	8.80
FRNR35	35	10	16.08
FRNR40	40	10	16.20
FRNR45	45	10	16.72
FRNR50	50	10	16.08
FRNR60	60	10	16.08
FRNR70	70	5	36.39
FRNR80	80	5	36.42
FRNR90	90	5	36.39
FRNR100	100	5	36.39
FRNR125	125	1	80.06
FRNR150	150	1	80.06
FRNR175	175	1	80.06
FRNR200	200	1	80.06
FRNR225	225	1	165.24
FRNR250	250	1	166.29
FRNR300	300	1	167.33
FRNR400	400	1	153.13
FRNR600	600	1	234.64
<b>600V AC</b>			
FRSR1	1	10	27.70
FRSR5	5	10	23.00
FRSR10	10	10	22.08
FRSR15	15	10	19.51
FRSR1712	17.5	10	19.66
FRSR20	20	10	19.51
FRSR25	25	10	19.51
FRSR30	30	10	19.51
FRSR35	35	10	33.46
FRSR40	40	10	33.46
FRSR45	45	10	33.46
FRSR50	50	10	33.46
FRSR60	60	10	33.46
FRSR70	70	5	69.16
FRSR80	80	5	69.16
FRSR90	90	5	69.16
FRSR100	100	5	69.16
FRSR125	125	1	138.30
FRSR150	150	1	138.30
FRSR175	175	1	138.30
FRSR200	200	1	138.30
FRSR225	225	1	276.53
FRSR250	250	1	276.53
FRSR300	300	1	276.53
FRSR400	400	1	276.53
FRSR600	600	1	401.36

Other Amperages Available.

For Motor Horsepower Ratings see Page L15.

**EDISON DUAL ELEMENT  
TIME DELAY**  
CLASS RK5 1A-600A  
250/600V AC 200 KAIC

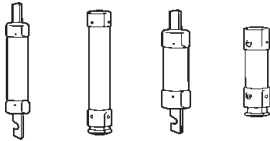

ECSR70 - ECSR1 - ECNR70 - ECNR1 - ECSR600 ECSR60 ECNR600 ECNR60

Vendor Code: **EDN**

Catalog Number	Amps	Carton Quantity	Price Each
<b>250V AC</b>			
ECNR1	1	10	10.23
ECNR5	5	10	11.22
ECNR10	10	10	8.94
ECNR15	15	10	9.38
ECNR20	20	10	9.38
ECNR25	25	10	9.38
ECNR30	30	10	9.38
ECNR35	35	10	12.90
ECNR40	40	10	12.21
ECNR45	45	10	13.12
ECNR50	50	10	12.48
ECNR60	60	10	11.81
ECNR70	70	5	29.08
ECNR80	80	5	29.27
ECNR90	90	5	29.63
ECNR100	100	5	27.01
ECNR125	125	1	64.02
ECNR150	150	1	63.83
ECNR175	175	1	65.29
ECNR200	200	1	58.07
ECNR225	225	1	122.26
ECNR250	250	1	122.43
ECNR300	300	1	121.62
ECNR400	400	1	111.17
ECNR600	600	1	189.59
<b>600V AC</b>			
ECSR1	1	10	19.47
ECSR5	5	10	17.06
ECSR10	10	10	16.50
ECSR15	15	10	14.21
ECSR1712	17.5	10	15.10
ECSR20	20	10	13.98
ECSR25	25	10	14.91
ECSR30	30	10	13.57
ECSR35	35	10	25.45
ECSR40	40	10	25.10
ECSR45	45	10	25.89
ECSR50	50	10	25.05
ECSR60	60	10	23.64
ECSR70	70	5	52.37
ECSR80	80	5	53.01
ECSR90	90	5	53.62
ECSR100	100	5	49.27
ECSR125	125	1	193.63
ECSR150	150	1	106.03
ECSR175	175	1	107.28
ECSR200	200	1	193.63
ECSR225	225	1	215.06
ECSR250	250	1	214.86
ECSR300	300	1	214.24
ECSR400	400	1	211.09
ECSR600	600	1	310.29

Other Amperages Available.

For Motor Horsepower Ratings see Page L15.

**EDISON ONE-TIME  
GENERAL PURPOSE**  
CLASS K5 1-600A 250/600V AC  
50 KAIC 0-60A  
10 KAIC 65-600A

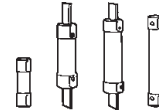

Vendor Code: **EDN**

Catalog Number	Amps	AIC	Carton Quantity	Price Each
<b>250V AC</b>				
KON30	30	50K	10	3.69
KON60	60	50K	10	6.32
KON100	100	10K	5	19.92
KON200	200	10K	5	37.64
<b>600V AC</b>				
KOS30	30	50K	10	21.35
KOS60	60	50K	10	34.09
KOS100	100	10K	5	69.17
KOS200	200	10K	5	172.56

Other Amperages Available.

**FUSE REDUCERS  
RK5 CLASS**

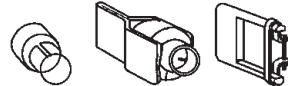

Vendor Code: **BUS**

Catalog Number	Volts	Fuse Size	Clip Size	Ctn. Qty.	Price Each
263R	250	30	60	10	11.22
216R	250	60	100	10	41.10
2621R	250/600	100	200	10	50.49
663R	600	30	60	10	11.94
N0.616R	600	60	100	10	26.70

**FUSE BLOCKS  
CLASS RK5, K5 & H**

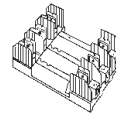

Vendor Code: **BUS**

Catalog Number	Poles	Max. Amps	Price Each
<b>250V AC</b>			
HM250301CR	1	30	18.02
HM250302CR	2	30	31.74
HM250303CR	3	30	45.94
HM250603CR	3	60	56.12
<b>600V AC</b>			
HM600303CR	3	30	57.12
HM600603CR	3	60	65.84

\*All Blocks Shown Have Box Lugs. Screw or Pressure Plate Terminals Available.



### DUAL ELEMENT TIME DELAY CLASS J - 600V AC

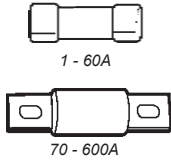

Vendor Code: EDN

Catalog Number	Amps	Carton Quantity	Price Each
JDL10	10	10	21.73
JDL12	12	10	24.85
JDL15	15	10	21.13
JDL20	20	10	20.81
JDL25	25	10	23.17
JDL30	30	10	20.55
JDL35	35	10	38.26
JDL40	40	10	36.91
JDL45	45	10	50.87
JDL50	50	10	37.61
JDL60	60	10	35.31
JDL70	70	1	80.40
JDL80	80	1	81.55
JDL90	90	1	72.56
JDL100	100	1	78.31
JDL125	125	1	167.91
JDL150	150	1	165.87
JDL175	175	1	166.02
JDL200	200	1	161.00
JDL250	250	1	326.79
JDL300	300	1	340.13
JDL400	400	1	333.47
JDL600	600	1	513.52

### TIME DELAY CLASS L 600V AC 200 KAIC



Vendor Code: EDN

Catalog Number	Amps	Carton Quantity	Price Each
<b>SILVER ELEMENT</b>			
LCL800	800	1	689.62
LCL1000	1,000	1	765.48
LCL1200	1,200	1	578.80
LCL1600	1,600	1	792.57
LCL2000	2,000	1	957.12
LCL3000	3,000	1	1624.24

For Technical Information see Pages L13–L15.

### REJECTION TIME DELAY 13/32" X 1-1/2" 600V AC 200 KAIC

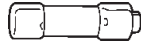

Vendor Code: EDN

Catalog Number	Amps	Carton Quantity	Price Each
HCTR1	1	10	17.33
HCTR112	1.5	10	18.79
HCTR2	2	10	18.05
HCTR3	3	10	17.94
HCTR5	5	10	17.64
HCTR10	10	10	18.37
HCTR30	30	10	18.76

### REJECTION FAST ACTING 13/32" X 1-1/2" 600V AC 200 KAIC

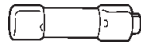

Vendor Code: EDN

Catalog Number	Amps	Carton Quantity	Price Each
HCLR1	1	10	17.69
HCLR2	2	10	18.00
HCLR3	3	10	18.19
HCLR4	4	10	19.97
HCLR5	5	10	16.92
HCLR6	6	10	19.62
HCLR8	8	10	19.83
HCLR10	10	10	17.13
HCLR15	15	10	17.52
HCLR20	20	10	17.67
HCLR25	25	10	19.98
HCLR30	30	10	16.91

### REJECTION TIME DELAY CURRENT LIMITING CLASS CC 13/32" X 1-1/2" 600V AC 200 KAIC

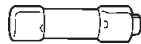

Vendor Code: EDN

Catalog Number	Amps	Carton Quantity	Price Each
EDCC1	1	10	25.22
EDCC3	3	10	25.22
EDCC5	5	10	22.49
EDCC10	10	10	22.49
EDCC15	15	10	21.21
EDCC20	20	10	21.09
EDCC30	30	10	20.62

### INLINE FUSE HOLDERS



Vendor Code: EDN

Catalog Number	Wire Size	Carton Quantity	Price Each
<b>NON-BREAKAWAY</b>			
HEBAA	#12-#8	1	25.93

### NON-REJECTION TIME DELAY 13/32" X 1-1/2" 250/500V AC 10 KAIC

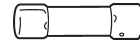

• Low cost supplemental protection of 125V, 250V and 480V inductive circuits

Vendor Code: EDN

Catalog Number	Amps	Carton Quantity	Price Each
<b>250V AC</b>			
MEN12	0.5	10	7.30
MEN1	1	10	6.64
MEN3	3	10	6.53
MEN4	4	10	6.71
MEN5	5	10	6.15
MEN10	10	10	5.91
MEN15	15	10	6.26
MEN20	20	10	6.49
MEN30	30	10	6.45
<b>500V AC</b>			
MEQ1	1	10	18.64
MEQ2	2	10	17.90
MEQ3	3	10	18.02
MEQ4	4	10	18.58
MEQ5	5	10	18.19
MEQ6	6	10	18.64
MEQ10	10	10	17.40
MEQ12	12	10	18.73
MEQ15	15	10	18.16
MEQ20	20	10	18.51
MEQ30	30	10	18.24



A

Distribution Equipment



Dual Element Time Delay Fuses · Rejection Fast Acting Fuses · Inline Fuse Holders

A

Distribution Equipment

**DUAL ELEMENT  
TIME DELAY  
CLASS J - 600V AC**

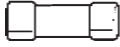

1 - 60A



70 - 600A

Vendor Code: **BUS**

Catalog Number	Amps	Carton Quantity	Price Each
LPJ10SP	10	10	30.55
LPJ12SP	12	10	35.04
LPJ15SP	15	10	30.55
LPJ20SP	20	10	29.99
LPJ25SP	25	10	29.99
LPJ30SP	30	10	30.55
LPJ35SP	35	10	50.16
LPJ40SP	40	10	50.16
LPJ45SP	45	10	50.16
LPJ50SP	50	10	50.16
LPJ60SP	60	10	50.16
LPJ70SP	70	1	105.56
LPJ80SP	80	1	105.56
LPJ90SP	90	1	119.10
LPJ100SP	100	1	105.56
LPJ125SP	125	1	215.31
LPJ150SP	150	1	215.31
LPJ175SP	175	1	236.23
LPJ200SP	200	1	211.19
LPJ250SP	250	1	423.81
LPJ300SP	300	1	457.98
LPJ400SP	400	1	436.16
LPJ600SP	600	1	760.76

**TIME DELAY  
CLASS L 600V AC 200 KAIC**



Vendor Code: **BUS**

Catalog Number	Amps	Carton Quantity	Price Each
<b>SILVER ELEMENT</b>			
KLU800	800	1	825.37
KLU1000	1,000	1	1093.94
KLU1200	1,200	1	978.60
KLU1600	1,600	1	1189.27
KLU2000	2,000	1	1436.17
KLU3000	3,000	1	2901.47

For Technical Information see Pages L13 - L15.

**REJECTION TIME DELAY  
13/32" X 1-1/2"  
600V AC 200 KAIC**

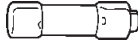

Vendor Code: **BUS**

Catalog Number	Amps	Carton Quantity	Price Each
FNQR1	1	10	25.29
FNQR112	1.5	10	25.86
FNQR2	2	10	25.86
FNQR3	3	10	25.57
FNQR5	5	10	25.86
FNQR10	10	10	27.23
FNQR30	30	10	26.60

**REJECTION FAST ACTING  
13/32" X 1-1/2"  
600V AC 200 KAIC**

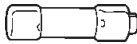

Vendor Code: **BUS**

Catalog Number	Amps	Carton Quantity	Price Each
KTKR1	1	10	21.14
KTKR2	2	10	21.14
KTKR3	3	10	21.14
KTKR4	4	10	24.68
KTKR5	5	10	21.14
KTKR6	6	10	24.33
KTKR8	8	10	24.68
KTKR10	10	10	21.14
KTKR15	15	10	21.14
KTKR20	20	10	21.14
KTKR25	25	10	22.49
KTKR30	30	10	21.14

**REJECTION TIME DELAY  
CURRENT LIMITING  
CLASS CC 13/32" X 1-1/2"  
600V AC 200 KAIC**

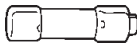

Vendor Code: **BUS**

Catalog Number	Amps	Carton Quantity	Price Each
LPCC1	1	10	26.43
LPCC3	3	10	26.43
LPCC5	5	10	34.36
LPCC10	10	10	26.43
LPCC15	15	10	26.43
LPCC20	20	10	26.43
LPCC30	30	10	26.43

**INLINE FUSE HOLDERS**

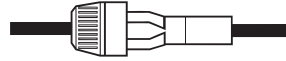

Vendor Code: **BUS**

Catalog Number	Wire Size	Carton Quantity	Price Each
<b>NON-BREAKAWAY</b>			
HEBAA	#12-#8	1	34.56

**NON-REJECTION  
TIME DELAY  
13/32" X 1-1/2"  
250/500V AC 10 KAIC**

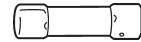

• Low cost supplemental protection of 125V, 250V and 480V inductive circuits

Vendor Code: **BUS**

Catalog Number	Amps	Carton Quantity	Price Each
<b>250V AC</b>			
FNM.5	0.5	10	10.16
FNM1	1	10	8.75
FNM3	3	10	9.17
FNM4	4	10	9.17
FNM5	5	10	8.00
FNM10	10	10	8.22
FNM15	15	10	8.00
FNM20	20	10	9.17
FNM30	30	10	9.17
<b>500V AC</b>			
FNQ1	1	10	23.05
FNQ2	2	10	23.05
FNQ3	3	10	23.05
FNQ4	4	10	23.05
FNQ5	5	10	23.05
FNQ6	6	10	23.05
FNQ10	10	10	23.05
FNQ12	12	10	34.53
FNQ15	15	10	23.05
FNQ20	20	10	23.05
FNQ30	30	10	23.05



**Bussmann series**





**ELECTRONIC FUSE**  
5MM X 20MM 250V AC

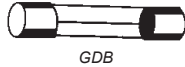

GDB

Vendor Code: **EDN**

Catalog Number	Amps	Carton Quantity	Price Each
<b>FAST ACTING, LOW BREAKING GLASS TUBE</b>			
GDB125MA	125 ma	5	2.96
GDB250MA	250 ma	5	3.02
GDB500MA	0.5	5	3.23
GDB1A	1	5	3.23
GDB2A	2	5	5.01
GDB4A	4	5	4.01
GDB10A	10	5	5.13
<b>TIME DELAY, LOW BREAKING GLASS TUBE</b>			
GDC2A	2	5	4.24

**ELECTRONIC FUSE FAST ACTING**  
1/4" X 1-1/4"

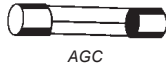

AGC

Vendor Code: **EDN**

Catalog Number	Amps	Volts	Carton Quantity	Price Each
<b>GLASS TUBE</b>				
AGC.5	0.5	250	5	1.75
AGC1	1	250	5	1.16
AGC2	2	250	5	1.16
AGC212	2.5	250	5	1.67
AGC3	3	250	5	1.16
AGC4	4	250	5	1.45
AGC5	5	250	5	1.69
AGC6	6	250	5	1.69
AGC10	10	250	5	1.53
AGC15	15	250	5	1.53
AGC20	20	250	5	1.45
AGC25	25	125	5	1.68
AGC30	30	125	5	1.45

**EAT·N**  
Bussmann series

For Technical Information see Pages L13 – L15.

**ELECTRONIC FUSE**  
**FAST ACTING**  
1/4" X 1-1/4" CERAMIC TUBE

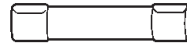

ABC

Vendor Code: **EDN**

Catalog Number	Amps	Volts	Carton Quantity	Price Each
ABC1R	1	250	5	1.15
ABC2R	2	250	5	1.58
ABC3R	3	250	5	1.58
ABC4R	4	250	5	1.83
ABC5R	5	250	5	1.54
ABC6R	6	250	5	1.79
ABC8R	8	250	5	1.51
ABC10R	10	250	5	1.54
ABC15R	15	250	5	1.17
ABC20R	20	250	5	1.64
ABC25R	25	125	5	1.63
ABC30R	30	125	5	2.50

**ELECTRONIC FUSE TIME DELAY**  
1/4" X 1-1/4"

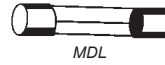

MDL



MDA

Vendor Code: **EDN**

Catalog Number	Amps	Volts	Carton Quantity	Price Each
<b>GLASS TUBE</b>				
MDL.5R	0.5	250	5	3.19
MDL1R	1	250	5	1.83
MDL2R	2	250	5	1.57
MDL3R	3	250	5	1.83
MDL4R	4	250	5	1.83
MDL5R	5	250	5	1.83
MDL7R	7	250	5	2.08
MDL8R	8	250	5	1.78
MDL10R	10	32	5	2.25
<b>CERAMIC TUBE</b>				
MDA1R	1	250	5	1.94
MDA2R	2	250	5	1.81
MDA3R	3	250	5	1.75
MDA4R	4	250	5	2.97
MDA5R	5	250	5	1.94
MDA7R	7	250	5	1.88
MDA8R	8	250	5	2.85
MDA15R	15	250	5	2.85
MDA20R	20	125	5	3.05

**A**  
Distribution Equipment



Compact Circuit Protectors · Cubefuses · UL Fuse Classification Chart

A

Distribution Equipment

COMPACT CIRCUIT PROTECTORS

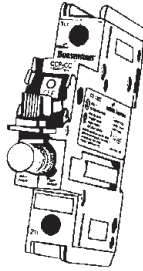

- 3X the protection - 1/3 the space of equivalent rated circuit breaker
- DIN RAIL mount for quick installation
- Finger safe construction
- Blown fuse indication
- 200 kA SCCR with low peak and Class CC fuses

Vendor Code: **BUS**

Catalog Number	Amps	Poles	Price Each
<b>CCP130CC</b>	30	1	35.60
<b>CCP230CC</b>	30	2	92.37
<b>CCP330CC</b>	30	3	139.11

CUBEFUSE DUAL ELEMENT TIME DELAY  
CLASS J 600V AC

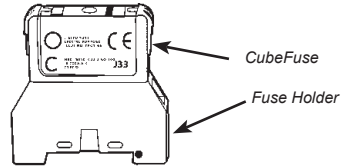

- Industry's first finger safe fuse!
- Small Footprint - Delivers class J performances in less space than Class CC size
- Permanent open fuse indicator
- Versatility - Fuse basics may be snapped together and mounted to 35 mm DIN rail or mounted directly to panel
- Used as branch circuit protection in new Bussmann selective coordination panelboard
- Blown fuse indicating

Vendor Code: **BUS**

Catalog Number	Amps	Carton Quantity	Price Each
<b>CUBEFUSES</b>			
<b>TCF15</b>	15	12	44.50
<b>TCF20</b>	20	12	44.50
<b>TCF30</b>	30	12	55.63
<b>TCF50</b>	50	12	84.06
<b>TCF60</b>	60	12	72.34
<b>TCF100</b>	100	6	148.21
<b>TCF200</b>	200	1	165.82
<b>CUBEFUSE HOLDERS</b>			
<b>TCFH30N</b>	30	12	13.81
<b>TCFH60N</b>	60	12	19.55
<b>TCFH100N</b>	100	6	23.56
<b>TCFH200N</b>	200	1	58.25

UL FUSE CLASSIFICATION CHART

UL Class	Fuse Overload Characteristics	Interrupting Rating, Amperes	AC Voltage Rating	Available Ampere Ratings	Bussman Series Number	Edison Series Number
<b>L</b>	Time-Delay	200,000	600	200 – 6000 601 – 4000 200 – 2000	KRPC KLU n/a	n/a LCL n/a
<b>RK1</b>	Time-Delay	200,000	250 600	1/10 – 600	LPNRK LPSRK	LENRK LESRK
	Fast-Acting	200,000	250 600	1 – 600	KTNR KTSR	NCLR SCLR
<b>RK5</b>	Time-Delay	200,000	250 600	1/10 – 600	FRNR FRSR	ECNR ECSR
<b>T</b>	Fast-Acting	200,000	300 600	1 – 1200	JJN JJS	TJN TJS
<b>J</b>	Time-Delay	200,000	600	1 – 600	LPJ	JDL
	Fast-Acting	200,000	600	1 – 600	JKS	JFL
<b>CC</b>	Time-Delay	200,000	600	1/10 – 30 1/4 – 30	FNQR LPCC	HCTR EDCC
	Fast-Acting	200,000	600	1/10 – 30	KTKR	HCLR
<b>CD</b>	Time-Delay	200,000	600	35 – 60	LPCC	EDCC
<b>G</b>	Time-Delay	100,000	480	1/2 – 60	SC	SEC
<b>K5</b>	Fast-Acting	50,000	250	1 – 600	NON NOS	KON KOS
			600			

\*LDC Rated 600 Volts AC/DC  
 \*\*JLLN Class T is UL Listed at 300 Volts  
 \*\*\*Class RK1 Fuses are Ultra-Fast Clearing



**B**  
Wiring Devices

SECTION



# Wiring Devices



Wiring Devices

Eaton Devices

Switches .....	B3
Decorator Devices .....	B4
Chargers.....	B4
Receptacles.....	B5
Cord Plugs and Connectors .....	B6
Appliance Cords and Receptacles.....	B7
Screwless Wall Plates .....	B8
Wall Plates.....	B9

Pass & Seymour Devices

Switches .....	B10
Decorator Devices .....	B10-B11
Receptacles.....	B10-B11
Chargers.....	B12
Cord Plugs and Connectors .....	B13
Turnlok® Devices .....	B13
Appliance Cords and Receptacles.....	B14
Screwless Wall Plates .....	B15
Wall Plates.....	B15-B16

Raceway

One-Piece Steel Raceway .....	B17
Non-Metallic Raceway .....	B18
Two-Piece Steel Raceway .....	B19-B20
Pancake Raceway.....	B20
Power Poles .....	B20

B

Wiring Devices



## Switches (Residential Grade · Industrial Grade · Commercial Grade)

### RESIDENTIAL GRADE

#### TOGGLE SWITCHES, PUSH & SIDE WIRE

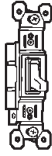

Vendor Code: **EWD**

Catalog Number	Amps	Volts	Ctn. Qty.	Price per 100 pcs.
<b>SINGLE POLE</b>				
13017W	15	120	10	83.93
<b>3-WAY</b>				
13037W	15	120	10	170.83
<b>4-WAY</b>				
12427WB0X	15	120	10	1146.00

Catalog Numbers Listed Above are White (W).  
Replace W with A for Almond, B for Brown, LA for Light Almond or V for Ivory.

### INDUSTRIAL GRADE

#### LOCKING SWITCHES, BACK & SIDE WIRE

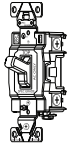

AH1221



AH1221L

Vendor Code: **EWD**

Catalog Number	Amps	Volts	Ctn. Qty.	Price Each
<b>SINGLE POLE</b>				
AH1221W	20	120/277	10	7.56
3031W	30	120/277	10	28.64
<b>SINGLE POLE LOCKING SWITCH</b>				
AH1221L	20	120/277	10	13.39
<b>SINGLE POLE PILOT LIGHTED</b>				
AH1221PL**	20	120/277	10	49.88
<b>DOUBLE POLE</b>				
AH1222W	20	120/277	10	14.24
3032W	30	120/277	10	37.01
<b>3-WAY</b>				
AH1223W	20	120/277	10	8.03
<b>3-WAY LOCKING SWITCH</b>				
AH1223L	20	120/277	10	16.62
<b>4-WAY SWITCH</b>				
AH1224W	20	120/277	10	28.32

With the Exception for the Following Catalog Numbers: AH1221L, AH1221PL, and AH1223L, All Catalog Numbers Listed Above are White (W).  
Replace W with B for Brown, BK for Black, GY for Gray, LA for Light Almond, RD for Red, or V for Ivory.

\*15 Amp also Available  
\*\*Red Color

### RESIDENTIAL GRADE

#### COMBINATION SWITCHES, BACK & SIDE WIRE

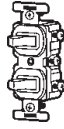

271, 275 or 276

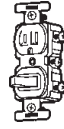

TR274



277

Vendor Code: **EWD**

Catalog Number	Amps	Volts	Ctn. Qty.	Price Each
<b>TWO SINGLE POLE SWITCHES</b>				
271WB0X	15	120/277	10	8.59
<b>SINGLE POLE SWITCH &amp; 3-WAY SWITCH</b>				
275WB0X	15	120/277	10	11.23
<b>TWO 3-WAY SWITCHES</b>				
276WB0X	15	120/277	10	11.22
<b>SINGLE POLE SWITCH &amp; RECEPTACLE</b>				
TR274W*	15	120/277	10	12.62
<b>SINGLE POLE SWITCH &amp; PILOT LIGHT</b>				
277WB0X	15	120	10	12.37

Catalog Numbers Listed Above are White (W).  
Replace W with A for Almond, B for Brown, BK for Black, LA for Light Almond or V for Ivory.  
\*Tamper Resistant

### COMMERCIAL GRADE

#### TOGGLE SWITCHES, SIDE WIRE



Vendor Code: **EWD**

Catalog Number	Amps	Volts	Ctn. Qty.	Price Each
<b>SINGLE POLE</b>				
CS115W	15	120/277	10	2.83
CS120W	20	120/277	10	401.00
<b>DOUBLE POLE</b>				
CS215W	15	120/277	10	5.56
CS220W	20	120/277	10	9.15
<b>3-WAY</b>				
CS315W	15	120/277	10	5.25
CS320W	20	120/277	10	6.07
<b>4-WAY</b>				
CS415WBU	15	120/277	10	1089.00
CS420WBU	20	120/277	10	19.46

Catalog Numbers Listed Above are White (W).  
Replace W with A for Almond, B for Brown, BK for Black, GY for Gray, LA for Light Almond or V for Ivory.





Decorator Devices (Switches · Receptacles · USB Charging Receptacles)

DECORATOR SWITCHES  
BACK, PUSH AND SIDE WIRE

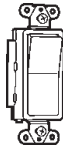

Vendor Code: **EWD**

Catalog Number	Amps	Volts	Carton Quantity	Price Each
<b>SINGLE POLE</b>				
7501W	15	120/277	10	2.26
<b>3-WAY</b>				
7503W	15	120/277	10	3.18
<b>4-WAY</b>				
7504WB0X	15	120/277	10	10.67

Catalog Numbers Listed Above are White (W).  
Replace W with A for Almond, B for Brown, BK for Black, GY for Gray, LA for Light Almond or V for Ivory.

RECEPTACLES WITH USB CHARGER

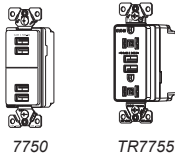

Vendor Code: **EWD**

Catalog Number	Amps	Volts	Carton Quantity	Price Each
<b>DUPLEX, NEMA 5-15R</b>				
7750WB0X	15	125	10	53.59
TR7755WB0X*	15	125	10	31.09

Catalog Numbers Listed Above are White (W).  
Replace W with A for Almond, B for Brown, BK for Black, GY for Gray, LA for Light Almond, or V for Ivory.  
\*Tamper Resistant

DECORATOR RECEPTACLES  
PUSH AND SIDE WIRE



Vendor Code: **EWD**

Catalog Number	Amps	Volts	Carton Quantity	Price Each
<b>DUPLEX, NEMA 5-15R</b>				
1107W	15	125	10	2.25
TR1107W*	15	125	10	3.51

Catalog Numbers Listed Above are White (W).  
Replace the W with B for Brown, LA for Light Almond, or V for Ivory.  
\*Tamper Resistant

**NEW** DECORATOR COMBINATION DEVICES  
COMMERCIAL GRADE, BACK & SIDE WIRE

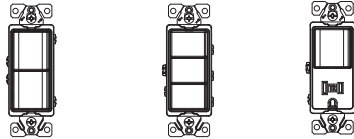

7728W

7729W

TR7730W

Vendor Code: **EWD**

Catalog Number	Amps	Volts	Carton Quantity	Price Each
<b>TWO SINGLE POLE SWITCHES</b>				
7728WB0X	15	120/277	1	11.67
<b>THREE SINGLE POLE SWITCHES</b>				
7729WB0X	15	120/277	1	21.22
<b>ONE SINGLE POLE SWITCH/ONE RECEPTACLE</b>				
TR7730W*	15	120	1	12.64
<b>DIMMABLE LED NIGHTLIGHT/RECEPTACLE</b>				
TR7735WB0X*	15	120	1	21.77
TR7736WB0X*	20	120	1	15.47
<b>DIMMABLE LED NIGHTLIGHT/SINGLE POLE SWITCH</b>				
7738WB0X	15	120	1	20.24

Catalog Numbers Listed Above are White (W). Replace W with A for Almond, BK for Black, LA for Light Almond, or V for Ivory.  
\*Tamper Resistant

**NEW** 5A USB CHARGING RECEPTACLES

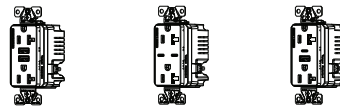

Dual USB-A

Dual USB-C

Dual USB-AC

- Standard tamper resistant duplex receptacle with two USB charging ports rated at a combined 5.0A @ 5VDC
- Auto-ground feature built into zinc-pated steel mounting strap
- Triple wipe blade contacts and double wipe ground contacts
- Back and side wire terminals

Vendor Code: **EWD**

Catalog Number	Amps	Volts	Carton Quantity	Price Each
<b>DUAL USB-A (TWO TYPE-A PORTS)</b>				
TRUSB5A15WB0X	15	125	10	36.71
TRUSB5A20WB0X	20	125	10	38.47
<b>DUAL USB-C (TWO TYPE-C PORTS)</b>				
TRUSBC15WB0X	15	125	10	45.06
TRUSBC20WB0X	20	125	10	48.63
<b>HYBRID USB-A/C (ONE TYPE-A &amp; ONE TYPE-C)</b>				
TRUSBAC15WB0X	15	125	10	42.58
TRUSBAC20WB0X	20	125	10	43.57

Catalog Numbers Listed Above are White (W).  
Replace W with B for Brown, BK for Black, GY for Gray, LA for Light Almond, V for Ivory.





### RESIDENTIAL GRADE RECEPTACLES

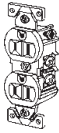

270



TR817

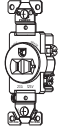

1877

Vendor Code: **EWD**

Catalog Number	Amps	Volts	Carton Quantity	Price per 100 pcs.
<b>DUPLEX, NEMA 5-15R, SIDE AND PUSH WIRE</b>				
270W	15	125	10	58.57
TR270W*	15	125	10	130.00
TWR270W**	15	125	10	234.00
<b>SINGLE, NEMA 5-15R, SIDE WIRE</b>				
TR817WBOX*	15	125	10	544.00
<b>SINGLE, NEMA 5-20R, SIDE WIRE</b>				
1877WBOX	20	125	10	401.00
<b>SINGLE, NEMA 6-20R, SIDE WIRE</b>				
1876WBOX	20	250	10	562.00

Catalog Numbers Listed Above are White (W).  
 Replace W with **B** for Brown, **LA** for Light Almond or **V** for Ivory  
 \*Tamper Resistant  
 \*\*Tamper and Weather Resistant

### SPECIALTY RECEPTACLES



8300W



IG5362RN

Vendor Code: **EWD**

Catalog Number	Amps	Volts	Carton Quantity	Price Each
<b>HOSPITAL GRADE, DUPLEX, NEMA 5-20R</b>				
8300W*	20	125	100	9.85
<b>ISOLATED GROUND, DUPLEX, NEMA 5-20R</b>				
IG5362RN**	20	125	100	6.84

\*Catalog Number Listed is White (W).  
 Replace W with **BK** for Black, **GY** for Gray, **RN** for Orange, **RD** for Red, or **V** for Ivory.  
 \*\*Catalog Number Listed is Orange (RN).



### COMMERCIAL GRADE RECEPTACLES

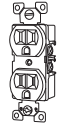

CR15

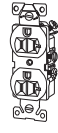

5362

Vendor Code: **EWD**

Catalog Number	Amps	Volts	Carton Quantity	Price Each
<b>COMMERCIAL GRADE, SIDE WIRE ONLY</b>				
CR15W	15	125	100	1.97
CR20W	20	125	100	2.70
<b>HEAVY DUTY, BACK AND SIDE WIRE</b>				
5362W	20	125	100	5.69

Catalog Numbers Listed Above are White (W).  
 Replace W with **A** for Almond, **B** for Brown, **BK** for Black, **GY** for Gray, **LA** for Light Almond, or **V** for Ivory.

### SPECIALTY DECORATOR



15 Amp



20 Amp



Dead Front

Vendor Code: **EWD**

Catalog Number	Amps	Volts	Carton Quantity	Price Each
<b>DUPLEX GFCI</b>				
SGF15W	15	125	10	13.83
SGF20W	20	125	10	17.29
<b>TAMPER RESISTANT DUPLEX GFCI</b>				
TRSGF15W*	15	125	10	16.12
<b>TAMPER AND WEATHER RESISTANT</b>				
TWRSGF15W*	15	125	10	17.23
TWRSGF20W*	20	125	10	18.34
<b>TAMPER RESISTANT AFCI, DUPLEX, NEMA 5-20R</b>				
TRAFCI20W*	20	125	100	32.93
<b>TAMPER RESISTANT AF/GF, DUPLEX, NEMA 5-20R</b>				
TRAFGF20W*	20	125	100	41.09
<b>HOSPITAL GRADE, SELF-TEST GFCI, NEMA 5-20R</b>				
SGFH20RD	20	125	100	39.58
<b>TAMPER RESISTANT WITH ALARM</b>				
TRSGFA15W*	15	125	10	23.32
<b>TAMPER RESISTANT WITH LED NIGHTLIGHT</b>				
TRSGFNL15W*	15	125	10	22.37
<b>DEAD FRONT GFCI</b>				
SGFD20W	20	125	10	32.87

Catalog Numbers Listed Above Except for SGFH20RD are White (W).  
 Replace W with **A** for Almond, **B** for Brown, **BK** for Black, **GY** for Gray, **LA** for Light Almond, or **V** for Ivory.  
 \*Tamper Resistant

**B**  
Wiring Devices

Cord Plugs and Connectors · Temporary Power Centers

PLUGS & CONNECTORS  
GENERAL DUTY



Plug

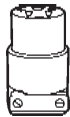

Connector

Vendor Code: **EWD**

Catalog Number	Description	Carton Quantity	Price Each
<b>15 AMPS, 125 VOLTS</b>			
4867B0X	5-15P Plug	10	4.82
4887B0X	5-15R Connector	10	7.55

SEVERE DUTY INDUSTRIAL GRADE  
YELLOW ELASTOMERIC BODY



Plug



Connector

Vendor Code: **EWD**

Catalog Number	Description	Carton Quantity	Price Each
<b>15 AMPS, 125 VOLTS</b>			
1447	5-15P Plug	10	10.46
1547	5-15R Connector	10	17.43

HEAVY DUTY  
INDUSTRIAL GRADE



Plug



Connector

Vendor Code: **EWD**

Catalog Number	Description	Ctn. Qty.	Recept. Diagram	Price Each
<b>15 AMPS, 125V</b>				
5266N	5-15P Plug	15		9.50
5269N	5-15C Conn.	15		17.18
<b>15 AMPS, 250V</b>				
AH5666	6-15P Plug	10		21.97
AH5669	6-15R Conn.	10		32.06
<b>20 AMPS, 125V</b>				
AH5366	5-20P Plug	10		20.40
AH5369	5-20R Conn.	10		24.27
<b>20 AMPS, 250V</b>				
AH5466	6-20P Plug	10		13.35
AH5469	6-20R Conn.	10		37.66

PLUGS & CONNECTORS  
AUTO GRIP NYLON BODY

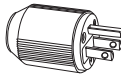

Plug

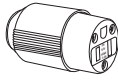

Connector

Vendor Code: **EWD**

Catalog Number	Description	Ctn. Qty.	Recept. Diagram	Price Each
<b>15 AMPS, 125 VOLTS</b>				
5266N	5-15P Plug	10		9.50
5269N	5-15C Conn.	10		17.18
<b>15 AMPS, 250 VOLTS</b>				
5666N	6-15P Plug	10		15.33
5669N	6-15C Conn.	10		26.20
<b>20 AMPS, 125 VOLTS</b>				
5366N	5-20P Plug	10		17.18
5369N	5-30C Conn.	10		28.64
<b>20 AMPS, 250 VOLTS</b>				
5466N	6-20P Plug	10		8.48
5469N	6-20C Conn.	10		45.82

ARROW HART LOCKING DEVICES  
2-POLE, 3-WIRE, GROUNDED



Connector



Plug



Receptacle

Vendor Code: **EWD**

Catalog Number	Description	Recept. Diagram	Price Each
<b>20 AMPS, 125 VOLTS</b>			
AHL520C	L5-20R Conn.		23.50
AHL520P	L5-20P Plug		15.48
AHL520R	L5-20R Recept.		18.10
<b>30 AMPS, 125 VOLTS</b>			
AHL530C	L5-30R Conn.		38.48
AHL530P	L5-30P Plug		16.80
AHL530R	L5-30R Recept.		26.35
<b>20 AMPS, 250 VOLTS</b>			
AHL620C	L6-20R Conn.		22.69
AHL620P	L6-20P Plug		15.47
AHL620R	L6-20R Recept.		19.49
<b>30 AMPS, 250 VOLTS</b>			
AHL630C	L6-30R Conn.		44.30
AHL630P	L6-30P Plug		24.06
AHL630R	L6-30R Recept.		29.55
<b>20 AMPS, 480 VOLTS</b>			
AHL820C	L8-20R Conn.		18.90
AHL820P	L8-20P Plug		16.04
AHL820R	L8-20R Recept.		21.80
<b>30 AMPS, 480 VOLTS</b>			
AHL830C	L8-30R Conn.		78.66
AHL830P	L8-30P Plug		39.32
AHL830R	L8-30R Recept.		46.98

ARROW HART LOCKING DEVICES  
3-POLE, 4-WIRE, GROUNDED

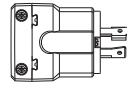

Plug



Receptacle

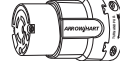

Connector

Vendor Code: **EWD**

Catalog Number	Description	Recept. Diagram	Price Each
<b>20 AMPS - 125/250 VOLTS</b>			
AHL1420C	L14-20R Conn.		32.15
AHL1420P	L14-20P Plug		23.25
AHL1420R	L14-20R Recept.		27.51
<b>30 AMPS - 125/250 VOLTS</b>			
AHL1430C	L14-30R Conn.		68.97
AHL1430P	L14-30P Plug		30.37
AHL1430R	L14-30R Recept.		41.81
<b>20 AMPS - 3 PHASE 250 VOLTS</b>			
AHL1520C	L15-20R Conn.		32.09
AHL1520P	L15-20P Plug		23.50
AHL1520R	L15-20R Recept.		26.94
<b>30 AMPS - 3 PHASE 250 VOLTS</b>			
AHL1530C	L15-30R Conn.		64.16
AHL1530P	L15-30P Plug		34.37
AHL1530R	L15-30R Recept.		41.81
<b>20 AMPS - 3 PHASE 480 VOLTS</b>			
AHL1620C	L16-20R Conn.		34.04
AHL1620P	L16-20P Plug		24.71
AHL1620R	L16-20R Recept.		27.48
<b>30 AMPS - 3 PHASE 480 VOLTS</b>			
AHL1630C	L16-30R Conn.		66.21
AHL1630P	L16-30P Plug		30.93
AHL1630R	L16-30R Recept.		43.55

**NEW** TEMPORARY POWER CENTERS



- NEMA Type 3R Stackable Enclosure
- Two 20A Devices per Circuit, Each with Breaker and GF Protection

Vendor Code: **EWD**

Catalog Number	Description	Price Each
<b>50 AMPS, 120/240 VOLTS</b>		
RB300ME	(6) 20A, 125V Duplex Recept. (1) 30A, 250V Locking Recept. (1) 50A, 125/250V Lock Inlet (1) 50A, 125/250V Lock Outlet	745.72
<b>50 AMPS, 125/250 VOLTS</b>		
CS6365EX	Plug, Locking, 3P-4W	91.66
CS6365EX	Connector, Locking 3P-4W	91.66

Other Configurations and Accessories Available.





## Receptacles · Power Outlets · Range and Dryer Cords · 120V Appliance Cords

### 4-WIRE RANGE RECEPTACLE

50A, 125/250V, NEMA 14-50R

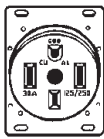

1258

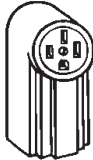

1212

Vendor Code: **EWD**

Catalog Number	Description	Carton Quantity	Price per 100 pcs.
<b>1258SP</b>	Flush	1	962.00
<b>1212</b>	Surface	1	14.61

### 4-WIRE DRYER RECEPTACLE

30A, 125/250V, NEMA 14-30R

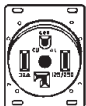

1257

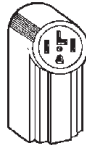

1225

Vendor Code: **EWD**

Catalog Number	Description	Carton Quantity	Price per 100 pcs.
<b>1257SP</b>	Flush	1	958.00
<b>1225</b>	Surface	1	14.61

### 4-RANGE & DRYER CORDS



Vendor Code: **COR**

Catalog Number	Description	Amps	Price Each
<b>RANGE 4-WIRE</b>			
<b>090448908</b>	4' Range Cord	50	35.91
<b>090468808</b>	6' Range Cord	50	46.53
<b>DRYER 4-WIRE</b>			
<b>091548908</b>	4' Dryer Cord	30	29.91
<b>091568808</b>	6' Dryer Cord	30	33.87



### FLUSH PLATES FOR RANGE AND DRYER RECEPTACLES



39CH

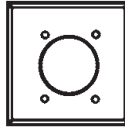

68

Vendor Code: **EWD**

Catalog Number	Description	Price per 100 pcs.
<b>1-GANG FOR 3 OR 4 WIRE DEVICE</b>		
<b>39CH</b>	Standard Size, Chrome	219.00
<b>2-GANG FOR 3 OR 4 WIRE DEVICE</b>		
<b>68</b>	Standard Size, Chrome	3.22
<b>PJ703W*</b>	Mid-Size, Polycarbonate	95.82

\*W for White, B for Brown, and V for Ivory

3-Wire Devices Available for Range Branch Circuits installed prior to 1996.

### 3-WIRE RANGE RECEPTACLE

50A, 125/250V, NEMA 10-50R



32B



38B

Vendor Code: **EWD**

Catalog Number	Description	Carton Quantity	Price Each
<b>32BBOX</b>	Flush	1	4.58
<b>38BBOX</b>	Flush	1	4.92

### 3-RANGE & DRYER CORDS

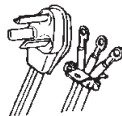

Vendor Code: **COR**

Catalog Number	Description	Amps	Price Each
<b>RANGE 3-WIRE</b>			
<b>090168909</b>	6' Range Cord	50	49.17
<b>DRYER 3-WIRE</b>			
<b>091248909</b>	4' Dryer Cord	30	16.08
<b>091268909</b>	6' Dryer Cord	30	20.89

### POWER OUTLETS

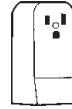

1234



1254 or 1252



1263

Vendor Code: **EWD**

Catalog Number	Amps	Volts	Description	Price per 100 pcs.
<b>NEMA TT-30R</b>				
<b>1263BOX</b>	30	125	Travel Trailer	1066.00
<b>NEMA 6-30R</b>				
<b>1234BOX</b>	30	250	Flush	1260.00
<b>NEMA 6-50R</b>				
<b>1254BOX</b>	50	250	Flush	1295.00
<b>1252</b>	50	250	Surface	19.23

### POWER CORD CAPS UNIVERSAL



S42		S21		83
6-30P	6-50P	14-30P	14-50P	TT-30P
30A	50A	30A	50A	30A
250V	250V	125/250V	125/250V	125V

Vendor Code: **EWD**

Catalog Number	Description	Price Each
<b>S42</b>	6-30P or 6-50P	25.22
<b>S21</b>	4-Wire Range or Dryer	18.51
<b>83</b>	Travel Trailer	12.23
<b>ADAPTER FOR 83 TRAVEL TRAILER</b>		
<b>1264</b>	30A, 125V to 15A, 120V	6.95

### 120V APPLIANCE CORDS

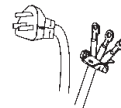

Straight

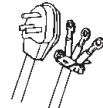

Angled

Vendor Code: **COR**

Catalog Number	Description	Price Each
<b>STRAIGHT PLUG</b>		
<b>097338809</b>	3', 16/3, SPT-3, Plugtail, Grey	3.94
<b>097368809</b>	6', 16/3, SPT-3, Plugtail, Grey	6.76
<b>09719</b>	9', 14/3, SJTW, Plugtail, Black	8.94
<b>ANGLED PLUG</b>		
<b>09724</b>	4', 16/3, SPT-3, Plugtail, Grey	6.03
<b>09726</b>	6', 16/3, SPT-3, Plugtail, Grey	6.64

Screwless Wall Plates (Toggle · Decorator)

MID-SIZE SCREWLESS WALL PLATES

Rugged construction reduces installation cost due to less plate breakage and resists bowing to provide a smooth, flat installation. Exclusive timesaving Screw-Catch feature that holds mounting screws captive and simplifies installation. High gloss finish is soil resistant. Polycarbonate wallplates are virtually unbreakable, with high structural rigidity, long-term form retention, and superior impact and abrasion resistance. Matching mounting screws provided.

Wiring Devices

**NEW**

DECORATOR WALL PLATES



Vendor Code: **EWD**

Catalog Number	Color	Carton Quantity	Price Each
<b>SINGLE GANG</b>			
PJS26W	White	20	3.74
PJS26A	Almond	20	3.74
PJS26B	Brown	20	3.74
PJS26BK	Black	20	3.74
PJS26GY	Grey	20	3.74
PJS26LA	Light Almond	20	3.74
PJS26V	Ivory	20	3.74

Polycarbonate Material

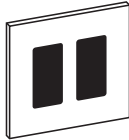

Vendor Code: **EWD**

Catalog Number	Color	Carton Quantity	Price Each
<b>2-GANG</b>			
PJS262W	White	20	7.29
PJS262V	Ivory	20	7.29
PJS262A	Almond	20	7.29
PJS262B	Brown	20	7.29
PJS262LA	Light Almond	20	7.29

Polycarbonate Material

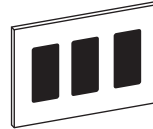

Vendor Code: **EWD**

Catalog Number	Color	Carton Quantity	Price Each
<b>3-GANG</b>			
PJS263W	White	10	9.49
PJS263A	Almond	10	9.49
PJS263BK	Black	10	9.49
PJS263LA	Light Almond	10	9.49
PJS263V	Ivory	10	9.49

Polycarbonate Material



Vendor Code: **EWD**

Catalog Number	Color	Carton Quantity	Price Each
<b>4-GANG</b>			
PJS264W	White	6	10.49
PJS264LA	Light Almond	6	10.49

Polycarbonate Material

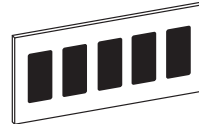

Vendor Code: **EWD**

Catalog Number	Color	Carton Quantity	Price Each
<b>5-GANG</b>			
PJS265W	White	6	11.37

Polycarbonate Material





## Toggle Wall Plates · Duplex Receptacle Wall Plates · Switch Plates

**NEW**

### TOGGLE WALL PLATES

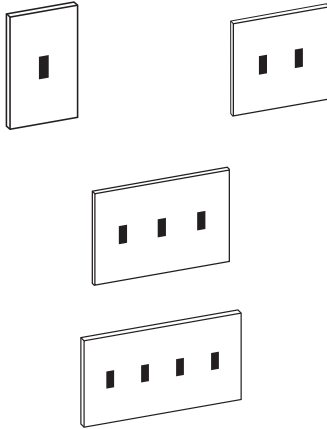

Vendor Code: **EWD**

Catalog Number	Color	Carton Quantity	Price Each
<b>SINGLE GANG</b>			
<b>PJS1W</b>	White	20	3.84
<b>2-GANG</b>			
<b>PJS2W</b>	White	100	6.36
<b>3-GANG</b>			
<b>PJS3W</b>	White	5	8.65
<b>4-GANG</b>			
<b>PJS4W</b>	White	30	10.27

Polycarbonate Material  
Catalog Numbers Listed Above are White (W).  
Replace the Letters in Black with **B** for **Brown** or **V** for **Ivory**.

**NEW**

### DUPLEX RECEPTACLE WALL PLATES



Vendor Code: **EWD**

Catalog Number	Color	Carton Quantity	Price Each
<b>SINGLE GANG</b>			
<b>PJS8W</b>	White	20	3.38
<b>PJS8V</b>	Ivory	20	3.38
<b>PJS8LA</b>	Light Almond	20	3.38

Polycarbonate Material



### SWITCH PLATES

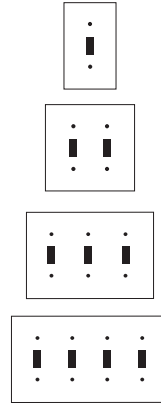

Vendor Code: **EWD**

Catalog Number	Color	Carton Quantity	Price per 100 pcs.
<b>MID-SIZE, POLYCARBONATE, 1-GANG</b>			
<b>PJ1V</b>	Ivory	25	34.64
<b>PJ1W</b>	White	25	34.64
<b>PJ1LA</b>	Light Almond	25	34.64
<b>PJ1B</b>	Brown	25	34.64
<b>MID-SIZE, POLYCARBONATE, 2-GANG</b>			
<b>PJ2V</b>	Ivory	25	94.89
<b>PJ2W</b>	White	25	94.89
<b>PJ2LA</b>	Light Almond	25	94.89
<b>PJ2B</b>	Brown	25	94.89
<b>MID-SIZE, POLYCARBONATE, 3-GANG</b>			
<b>PJ3V</b>	Ivory	10	144.00
<b>PJ3W</b>	White	10	144.00
<b>PJ3LA</b>	Light Almond	10	144.00
<b>PJ3B</b>	Brown	10	144.00
<b>MID-SIZE, POLYCARBONATE, 4-GANG</b>			
<b>PJ4V</b>	Ivory	10	201.92
<b>PJ4W</b>	White	10	201.92
<b>PJ4LA</b>	Light Almond	10	201.92
<b>PJ4B</b>	Brown	10	201.92

Replace the Letters in Black with **GY** for **Gray**, **A** for **Almond** or **BK** for **Black**.

### SINGLE RECEPTACLE PLATES



Vendor Code: **EWD**

Catalog Number	Power Outlet Hole Size	Color	Carton Quantity	Price per 100 pcs.
<b>MID-SIZE, POLYCARBONATE, 1-GANG</b>				
<b>PJ7V</b>	1.4"	Ivory	25	44.97
<b>PJ7W</b>	1.4"	White	25	44.97
<b>PJ7B</b>	1.4"	Brown	25	44.97

**B**

Wiring Devices

DUPLEX RECEPTACLE PLATES



Vendor Code: EWD

Catalog Number	Color	Carton Quantity	Price per 100 pcs.
<b>MID-SIZE, POLYCARBONATE, 1-GANG</b>			
PJ8V	Ivory	10	33.80
PJ8W	White	10	33.80
PJ8LA	Light Almond	10	33.80
PJ8B	Brown	10	33.80
<b>MID-SIZE, POLYCARBONATE, 2-GANG</b>			
PJ82V	Ivory	25	94.19
PJ82W	White	25	94.19
PJ82LA	Light Almond	25	94.19
PJ82B	Brown	25	94.19

TWO GANG COMBO PLATES  
SWITCH & DUPLEX RECEPTACLE



Vendor Code: EWD

Catalog Number	Color	Carton Quantity	Price per 100 pcs.
<b>MID-SIZE, POLYCARBONATE</b>			
PJ18V	Ivory	25	96.85
PJ18W	White	25	96.85
PJ18B	Brown	25	96.85
PJ18LA	Light Almond	25	96.85

WALL PLATE SCREWS



Vendor Code: EWD

Catalog Number	Color	Size	Carton Quantity	Price per 100 pcs.
231VBOX	Ivory	6-32" x 1/2"	100	22.47
231WBOX	White	6-32" x 1/2"	100	22.47
231BBOX	Brown	6-32" x 1/2"	100	22.47

BLANK DECOR INSERT

Vendor Code: EWD

Catalog Number	Color	Carton Quantity	Price per 100 pcs.
2160WBOX	White	5	398.97

Replace the Letters in Black with **GY** for Gray, **A** for Almond or **BK** for Black.



THREE GANG

2 SWITCHES & RECEPTACLE



Vendor Code: EWD

Catalog Number	Color	Carton Quantity	Price per 100 pcs.
<b>MID-SIZE, POLY, 2 TOGGLES &amp; DUPLEX</b>			
PJ28W	White		69.97
<b>MID-SIZE, POLY, 2 TOGGLES &amp; DECOR</b>			
PJ226W	White		156.00

W=White, B= Brown, V = Ivory, LA = Light Almond

BLANK PLATES



Vendor Code: EWD

Catalog Number	Color	Carton Quantity	Price per 100 pcs.
<b>MID-SIZE, POLYCARBONATE, 1-GANG</b>			
PJ13W	White	25	47.98
<b>MID-SIZE, POLYCARBONATE, 2-GANG</b>			
PJ23W	White	25	89.87

W=White, B= Brown, V = Ivory, LA = Light Almond

DECORATOR WALL PLATES

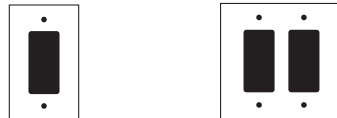

Vendor Code: EWD

Catalog Number	Color	Carton Quantity	Price per 100 pcs.
<b>MID SIZE, POLYCARBONATE, 1-GANG</b>			
PJ26V	Ivory	25	50.39
PJ26W	White	25	50.39
PJ26LA	Light Almond	25	50.39
PJ26B	Brown	25	50.39
<b>MID SIZE, POLYCARBONATE, 2-GANG</b>			
PJ262V	Ivory	25	94.78
PJ262W	White	25	94.78
PJ262LA	Light Almond	25	94.78
<b>MID SIZE, POLYCARBONATE, 3-GANG</b>			
PJ263V	Ivory	10	144.43
PJ263W	White	10	144.43
PJ263LA	Light Almond	10	144.43
<b>MID SIZE, POLYCARBONATE, 4-GANG</b>			
PJ264V	Ivory	10	199.82
PJ264W	White	10	199.82
PJ264LA	Light Almond	10	199.82



## Switches (Residential · Commercial · Heavy Duty)

### RESIDENTIAL GRADE

#### TOGGLE SWITCHES PUSH AND SIDE WIRE



663

Vendor Code: **PAS**

Catalog Number	Amps	Volts	Ctn. Qty.	Price per 100 pcs.
<b>SINGLE POLE</b>				
660WG	15	120	10	84.69
<b>3-WAY</b>				
663WG	15	120	10	188.88
<b>4-WAY</b>				
664WG	15	120	10	1138.97

Catalog Numbers Listed Above are White (W). Remove W for Brown or Replace W with BK for Black, I for Ivory, or LA for Light Almond.

#### COMBINATION SWITCHES SIDE WIRE

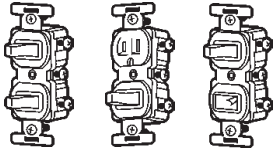

690, 696 or 693

691

692

Vendor Code: **PAS**

Catalog Number	Amps	Volts	Ctn. Qty.	Price per 100 pcs.
<b>TWO SINGLE POLES</b>				
690WG	15	120/277	10	912.24
<b>SINGLE POLE AND 3-WAY</b>				
696WG	15	120/277	10	1179.11
<b>TWO 3-WAYS, SIDE WIRE</b>				
693WG	15	120/277	10	2558.49
<b>SINGLE POLE AND RECEPTACLE</b>				
691W	15	120/125	10	921.23
691TRW	15	120/125	10	1834.21
<b>SINGLE POLE AND PILOT LIGHT</b>				
692WG	15	120/277	10	1497.99

Catalog Numbers Listed Above are White (W). Remove W for Brown or Replace W with I for Ivory, or LA for Light Almond. \*Tamper Resistant



#### DECORATOR SWITCHES PUSH AND SIDE WIRE



TM870

- Extra-long strap
- Unbreakable thermoplastic construction
- Long-term blade retention
- Extra large circuit break-off tabs
- New pressure plates for stranded wire

Vendor Code: **PAS**

Catalog Number	Amps	Volts	Ctn. Qty.	Price per 100 pcs.
<b>SINGLE POLE</b>				
TM870W	15	120/277	10	255.54
<b>3-WAY</b>				
TM873W	15	120/277	10	445.41
<b>4-WAY</b>				
TM874W	15	120/277	10	1499.99

Catalog Numbers Listed Above are White (W). Remove W for Brown or Replace W with I for Ivory, LA for Light Almond, BK for Black, or GRY for Gray.

#### DECORATOR SWITCHES RADIANT® COMBINATION DEVICES

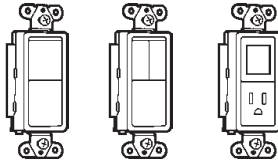

RCD11

RCD113

RCD38TR

Vendor Code: **PAS**

Catalog Number	Amps	Volts	Ctn. Qty.	Price Each
<b>TWO SINGLE POLES</b>				
RCD11W	15	120/277	10	10.49
<b>SINGLE POLE AND 3-WAY</b>				
RCD33W	15	120/277	10	29.97
<b>THREE SINGLE POLES</b>				
RCD113W	15	120	10	31.59
<b>SINGLE POLE/3-WAY SWITCH AND 15 AMP TAMPER-RESISTANT RECEPTACLE</b>				
RCD38TRW	15	120/125	10	17.49

Catalog Numbers Listed Above are White (W). Remove W for Brown or Replace W with I for Ivory, LA for Light Almond, or BK for Black.

For a complete listing of motion activated switches see Page C42.

### COMMERCIAL GRADE

#### COMMERCIAL SPEC SWITCHES SIDE WIRE



CS15AC1

Vendor Code: **PAS**

Catalog Number	Amps	Volts	Ctn. Qty.	Price per 100 pcs.
<b>SINGLE POLE</b>				
CS15AC1W	15	120/277	10	279.97
CS20AC1W	20	120/277	10	393.74
<b>3-WAY</b>				
CS15AC3W	15	120/277	10	611.67
CS20AC3W	20	120/277	10	604.05

Catalog Numbers Listed Above are White (W). Remove W for Brown or Replace W with I for Ivory, LA for Light Almond, BK for Black, or GRY for Gray.

#### HEAVY DUTY SPECIFICATION GRADE

#### TOGGLE SWITCHES BACK & SIDE WIRE

Vendor Code: **PAS**

Catalog Number	Amps	Volts	Ctn. Qty.	Price per 100 pcs.
<b>SINGLE POLE</b>				
PS20AC1W	20	120/277	10	1057.12
<b>DOUBLE POLE</b>				
PS20AC2W	20	120/277	10	2504.31
PS30AC2W	30	120/277	10	2127.97
<b>3-WAY</b>				
PS20AC3W	20	120/277	10	1449.97
<b>4-WAY</b>				
PS20AC4W	20	120/277	10	2497.98

Catalog Numbers Listed Above are White (W). Remove W for Brown or Replace W with I for Ivory, LA for Light Almond, GRY for Gray, or RED for Red.

#### LOCK SWITCHES BACK AND SIDE WIRE



Vendor Code: **PAS**

Catalog Number	Amps	Volts	Ctn. Qty.	Price per 100 pcs.
<b>SINGLE POLE</b>				
PS20AC1L*	20	120/277	10	2897.97

Catalog Numbers Listed Above are Gray. \*Key Can Be Removed in Both Positions.



Wiring Devices



RECEPTACLES

RESIDENTIAL

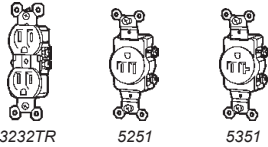

Vendor Code: PAS

Catalog Number	Amps	Volts	Ctn. Qty.	Price per 100 pcs.
<b>DUPLEX</b>				
3232W	15	125	10	53.29
3232TRW*	15	125	10	120.27
3232TRWRW**	15	125	10	277.36
<b>SINGLE, NEMA 5-15R</b>				
5251W	15	125	10	466.44
TR5251W*	15	125	10	624.56
<b>SINGLE, NEMA 5-20R</b>				
5351W	20	125	10	490.45
TR5351W*	20	125	10	960.00
<b>SHORT STRAP SINGLE, NEMA 6-20R</b>				
5851W	20	250	10	631.26

\*Tamper Resistant  
\*\*Tamper and Weather Resistant

DECORATOR



Vendor Code: PAS

Catalog Number	Amps	Volts	Ctn. Qty.	Price per 100 pcs.
<b>DUPLEX, NEMA 5-15R</b>				
885W	15	125	10	249.54
885TRW*	15	125	10	344.24
885TRWRW**	15	125	10	488.00

\*Tamper Resistant  
\*\*Tamper Resistant and Weather Resistant  
Catalog Numbers Listed Above are White (W). Remove W for Brown or Replace W with BK for Black, DB for Dark Bronze, G for Graphite, GRY for Gray, I for Ivory, LA for Light Almond, NI for Nickel, or RED for Red.

NIGHT LIGHTS



Vendor Code: PAS

Catalog Number	Amps	Volts	Ctn. Qty.	Price Each
NTL885TRWCC6*	15	125	1	22.26
NTLFULLW**		Full Night Light		17.90

\*Night Light and GFCI  
\*\*Louver included

USB CHARGER W/ TAMPER RESISTANT RECEPTACLE

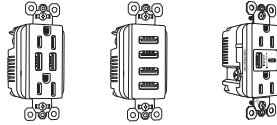

Vendor Code: PAS

Catalog Number	Amps	Volts	Ctn. Qty.	Price Each
TM826USBWCC6	15	125	6	33.49
TM8USB4WCC6	15	125	6	47.97
R26USBAC6W	15	125		32.50

Catalog Numbers Listed Above are White (W). Replace W with BK for Black, DB for Dark Bronze, I for Ivory, LA for Light Almond, or NI for Nickel.

ARC FAULT PROTECTION

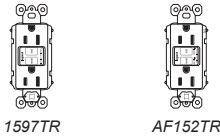

Vendor Code: PAS

Catalog Number	Amps	Volts	Ctn. Qty.	Price Each
<b>DUPLEX, NEMA 5-15R GFI</b>				
1597W	15	125	10	16.27
1597TRW*	15	125	10	13.97
<b>DUPLEX, NEMA 5-20R GFI</b>				
2097W	20	125	10	18.48
2097TRW*	20	125	10	18.96
<b>WEATHER RESISTANT GFI</b>				
1597TRWRW*	15	125	1	23.48
2097TRWRW*	20	125	1	24.79
<b>DEAD FRONT FEED THROUGH GFI</b>				
2087W	20	125	10	34.39
<b>AFCI</b>				
AF152TRW*	15	125		31.14
AF202TRW*	20	125		35.36
<b>DUAL FUNCTION - AFCI/GFCI</b>				
AFGF152TRW*	15	125		42.17
AFGF202TRW*	20	125		43.77

Catalog Numbers Listed Above are White (W). Remove W for Brown or Replace W with BK for Black, DB for Dark Bronze, G for Graphite, GRY for Gray, I for Ivory, LA for Light Almond, NI for Nickel, or RED for Red.

\*Tamper Resistant



COMMERCIAL / INDUSTRIAL



Vendor Code: PAS

Catalog Number	Amps	Volts	Ctn. Qty.	Price per 100 pcs.
<b>COMMERCIAL GRADE, SIDE WIRE ONLY</b>				
CR15W	15	125	10	227.97
CR20W	20	125	10	233.80
<b>INDUSTRIAL GRADE, BACK &amp; SIDE WIRE</b>				
5362W	20	125	10	527.32

Catalog Numbers Listed Above are White (W). Remove W for Brown or Replace W with BK for Black, GRY for Gray, I for Ivory, or LA for Light Almond.

ISOLATED GROUND

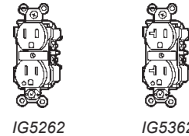

Vendor Code: PAS

Catalog Number	Amps	Volts	Ctn. Qty.	Price per 100 pcs.
<b>DUPLEX, NEMA 5-15R</b>				
IG5262	15	125	10	1018.25
<b>DUPLEX, NEMA 5-20R</b>				
IG5362	20	125	10	1056.54

Catalog Numbers Listed Above are Orange. Add the Suffix GRY for Gray, I for Ivory, LA for Light Almond, RED for Red, or W for White.

HOSPITAL GRADE

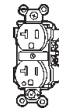

8300H

Vendor Code: PAS

Catalog Number	Amps	Volts	Ctn. Qty.	Price per 100 pcs.
<b>DUPLEX, NEMA 5-20R</b>				
8300HW	20	125	10	839.97

Catalog Numbers Listed Above are White (W). Remove W for Brown or Replace W with BK for Black, GRY for Gray, I for Ivory, LA for Light Almond, or R for Red.

B

Wiring Devices

### PLUGS & CONNECTORS

#### GENERAL DUTY

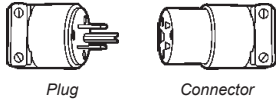

Plug

Connector

 Vendor Code: **PAS**

Catalog Number	Amps	Volts	Description	Ctn. Qty.	Price per 100 pcs.
<b>5276BK</b>	15	125	5-15P Plug	10	423.36
<b>5296BK</b>	15	125	5-15C Conn.	10	739.10

Catalog Numbers Listed Above are Black.

#### HINGED PLUG AND CONNECTOR

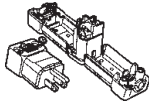

- Tough nylon construction with crush/impact resistance that exceeds hospital grade and Fed Spec requirements; arc resistance exceeds UL requirements.
- Self-hinge swings wide open to make quick, easy work of tight, clean connections.
- Enclosed terminals provide solid, internally-clamped connections.
- Molded finger grips promote safe, sure handling.

 Vendor Code: **PAS**

Catalog Number	Amps	Volts	Description	Ctn. Qty.	Price Each
<b>PS5965Y</b>	15	125	5-15P Plug	1	7.20
<b>PS5969Y</b>	15	125	5-15C Conn.	1	11.80

 Catalog Numbers Listed Above are Yellow (Y). Replace Y with **O** for Orange.

#### HOSPITAL GRADE



Plug

Connector

- See-through, thermoplastic terminal chamber for clear view of terminals and wire connections.
- All 3-wire terminals located on the same plane, allows for quick wire termination from any angle.
- Heavy-duty brass alloy blades and contacts, resist heat rise, provide excellent conductivity.
- Cord-grip screws recessed to protect installer against screwdriver head slippage.

 Vendor Code: **PAS**

Catalog Number	Amps	Volts	Description	Ctn. Qty.	Price per 100 pcs.
<b>PS5266XHG</b>	15	125	5-15P Plug	10	1498.97
<b>PS5269XHG</b>	15	125	5-15C Conn.	10	2697.99

Catalog Numbers Listed Above are Black.

#### HEAVY DUTY, INDUSTRIAL GRADE, YELLOW RUBBER BODY

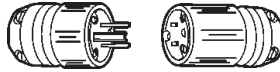

Plug

Connector

- Rubber body construction stands up to impacts, oils, chemicals, heat, and weather.
- Floating blades allow self-alignment with contacts.
- Terminal screws backed-out, ready-to-wire, saving time and money.
- Nickel-plated blades and contacts for long-lasting, superior corrosion resistance.
- Self-centering cord clamps provide superior strain relief.
- Compression-type cord grip provides watertight seal and 205 lb. pull out strength.

 Vendor Code: **PAS**

Catalog Number	Amps	Volts	Description	Ctn. Qty.	Price Each
<b>1447</b>	15	125	5-15P Plug	10	19.87
<b>1547</b>	15	125	5-15C Conn.	10	18.82

Catalog Numbers Listed Above are Yellow.

#### EXTRA HARD USE, NYLON BODY

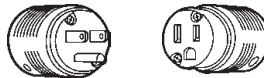

Plug

Connector

- Unit arrives completely ready-to-wire, cuts installation time significantly.
- Rugged two-piece cord grip provides more uniform cord retention.
- Internal dust shield keeps terminals free of contaminants.
- Tri-drive assembly screws are standard on all Specification Grade plugs and connectors.
- All 3-wire terminals located on the same plane, allows for quick wire termination from any angle.
- Heavy-duty brass alloy blades and contacts, resist heat rise, provide excellent conductivity.

 Vendor Code: **PAS**

Catalog Number	Amps	Volts	Description	Ctn. Qty.	Price per 100 pcs.
<b>PS5266X</b>	15	125	5-15P Plug	10	1530.20
<b>PS5269X</b>	15	125	5-15C Conn.	10	2228.65
<b>PS5666X</b>	15	250	6-15P Plug	10	2048.84
<b>PS5669X</b>	15	250	6-15C Conn.	10	3458.14
<b>PS5366X</b>	20	125	5-20C Plug	10	2363.22
<b>PS5369X</b>	20	125	5-20C Conn.	10	3952.91
<b>PS5466X</b>	20	250	6-20C Plug	10	2155.38
<b>PS5469X</b>	20	250	6-20C Conn.	10	4299.45

Catalog Numbers Listed Above are Black.



### TURNLOK® Devices

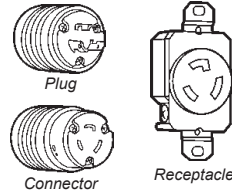

Plug

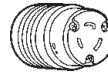

Connector

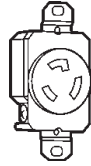

Receptacle

#### TWOPOLE, THREE WIRE, GROUNDED

 Vendor Code: **PAS**

Catalog Number	Description	Recept. Diagram	Price Per 100 pcs.
<b>15 AMP, 125 VOLT</b>			
<b>PSL515C</b>	NEMA L5-15C Conn.		2780.26
<b>L515P</b>	NEMA L5-15P Plug		1765.93
<b>4710</b>	NEMA L5-15R Recept.		2355.56

#### 20 AMP, 125 VOLT

<b>L520C</b>	NEMA L5-30C Conn.		3048.56
<b>L520P</b>	NEMA L5-20P Plug		2163.62
<b>L520R</b>	NEMA L5-20R Recept.		2470.21

#### 30 AMP, 125 VOLT

<b>L530C</b>	NEMA L5-30C Conn.		3782.83
<b>L530P</b>	NEMA L5-30P Plug		3406.66
<b>L530R</b>	NEMA L5-30R Recept.		3161.59

#### 20 AMP, 250 VOLT

<b>L620C</b>	NEMA L6-20C Conn.		2507.47
<b>L620P</b>	NEMA L6-20P Plug		1412.49
<b>L620R</b>	NEMA L6-20R Recept.		2874.92

#### 30 AMP, 250 VOLT

<b>L630C</b>	NEMA L6-30C Conn.		5502.96
<b>L630P</b>	NEMA L6-30P Plug		3481.19
<b>L630R</b>	NEMA L6-30R Recept.		4375.67

#### 20 AMP, 480 VOLT

<b>L820C</b>	NEMA L8-20C Conn.		2224.27
<b>L820P</b>	NEMA L8-20P Plug		1422.22
<b>L820R</b>	NEMA L8-20R Recept.		2760.25

#### 20 AMP, 125 VOLT, ISOLATED GROUND

<b>IGL520R</b>	NEMA L5-20R Recept.		4282.34
----------------	---------------------	--	---------

#### THREEPOLE, FOUR WIRE, GROUNDED

 Vendor Code: **PAS**

Catalog Number	Description	Recept. Diagram	Price per 100 pcs.
<b>20 AMP - 125/250V</b>			
<b>L1420C</b>	NEMA L14-20C Conn.		4542.90
<b>L1420P</b>	NEMA L14-20P Plug		3337.14
<b>L1420R</b>	NEMA L14-20R Recept.		3928.02

#### 30 AMP - 125V/250V

<b>L1430C</b>	NEMA L14-30C Conn.		7536.59
<b>L1430P</b>	NEMA L14-30P Plug		4452.19
<b>L1430R</b>	NEMA L14-30R Recept.		6213.05

#### 20 AMP 3 PHASE 250V

<b>L1520C</b>	NEMA L15-20C Conn.		4567.32
<b>L1520P</b>	NEMA L15-20P Plug		3518.50
<b>L1520R</b>	NEMA L15-20R Recept.		4047.44

#### 30 AMP 3 PHASE 250V

<b>L1530C</b>	NEMA L15-30C Conn.		8937.49
<b>L1530P</b>	NEMA L15-30P Plug		4566.05
<b>L1530R</b>	NEMA L15-30R Recept.		6213.05

#### 20 AMP 3 PHASE 480V

<b>L1620C</b>	NEMA L16-20C Conn.		4697.45
<b>L1620P</b>	NEMA L16-20P Plug		3539.11
<b>L1620R</b>	NEMA L16-20R Recept.		4040.89

#### 30 AMP 3 PHASE 480V

<b>L1630C</b>	NEMA L16-30C Conn.		9068.30
<b>L1630P</b>	NEMA L16-30P Plug		2785.71
<b>L1630R</b>	NEMA L16-30R Recept.		6311.71

Catalog Numbers Listed Above are Black.

See NEMA Turnlok configuration chart on Page L17.



B

Wiring Devices

**4-WIRE RANGE RECEPTACLE**  
50A, 125/250V

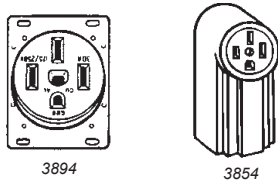

Vendor Code: **PAS**

Catalog Number	Description	Carton Quantity	Price per 100 pcs.
3894	14-50R, Flush	1	1132.19
3854	14-50R, Surface	1	1691.11

**4-WIRE DRYER RECEPTACLE**  
30A, 125/250V

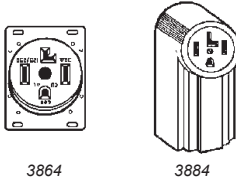

Vendor Code: **PAS**

Catalog Number	Description	Carton Quantity	Price per 100 pcs.
3864	14-30R, Flush	1	1095.55
3884	14-30R, Surface	1	1691.11

**4-RANGE & DRYER CORDS**



Vendor Code: **COR**

Catalog Number	Description	Amps	Price Each
<b>RANGE 4-WIRE</b>			
090448908	4' Range Cord	45	35.91
090468808	6' Range Cord	45	46.53
<b>DRYER 4-WIRE</b>			
091548908	4' Dryer Cord	30	29.91
091568808	6' Dryer Cord	30	33.87



**FLUSH PLATES FOR RANGE AND DRYER RECEPTACLES**

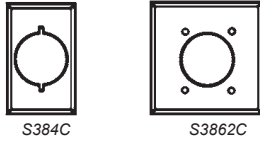

Vendor Code: **PAS**

Catalog Number	Description	Price per 100 pcs.
<b>1-GANG FOR 3 OR 4 WIRE DEVICE</b>		
S384C	Steel, Aluminum Finish	288.87
<b>2-GANG FOR 3 OR 4 WIRE DEVICE</b>		
S3862C	Steel, Chrome Finish	429.57

3-Wire Devices Available for Range Branch Circuits installed prior to 1996.

**3-WIRE RANGE RECEPTACLE**  
50A, 125/250V, NEMA 10-50R

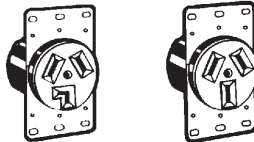

Vendor Code: **PAS**

Catalog Number	Description	Carton Quantity	Price per 100 pcs.
3860	Flush	1	485.57
3890	Flush	1	485.57

**3-RANGE & DRYER CORDS**

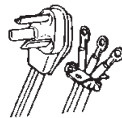

Vendor Code: **COR**

Catalog Number	Description	Amps	Price Each
<b>RANGE 3-WIRE</b>			
090168909	6' Range Cord	50	49.17
<b>DRYER 3-WIRE</b>			
091248909	4' Dryer Cord	30	16.08
091268909	6' Dryer Cord	30	20.89

**POWER OUTLETS**

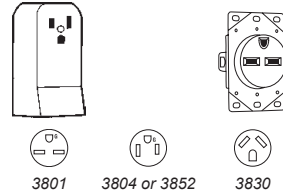

Vendor Code: **PAS**

Catalog Number	Amps	Volts	Description	Ctn. Qty.	Price per 100 pcs.
<b>NEMA TT-30R</b>					
3830	30	125	Travel Trailer	1	1168.01
<b>NEMA 6-30R</b>					
3801	30	250	Flush	1	1501.78
<b>NEMA 6-50R</b>					
3804	50	250	Flush	1	1501.78
3852	50	250	Surface	1	2003.34

**POWER CORD CAPS**  
UNIVERSAL



3869	3867	83CC4
6-30P 30A 250V	6-50P 50A 250V	14-30P 30A 125/250V
14-50P 50A 125/250V	TT-30P 30A 125V	

Vendor Code: **PAS**

Catalog Number	Description	Price per 100 pcs.
3869	Tandem & Parallel	1680.32
3867	4-Wire Range & Dryer	1621.59
83CC4	Travel Trailer	1181.89

**120V APPLIANCE CORDS**

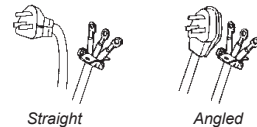

Vendor Code: **COR**

Catalog Number	Description	Price Each
<b>STRAIGHT PLUG</b>		
097338809	3', 16/3, SPT-3, Plugtail, Grey	3.94
097368809	6', 16/3, SPT-3, Plugtail, Grey	6.76
09719	9', 14/3, SJTW, Plugtail, Black	8.94
<b>ANGLED PLUG</b>		
09724	4', 16/3, SPT-3, Plugtail, Grey	6.03
09726	6', 16/3, SPT-3, Plugtail, Grey	6.64





### SCREWLESS WALL PLATES

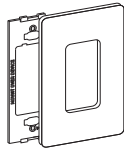

A step above the standard with no unsightly screws, this modern, low-profile wall plate instantly elevates the look of radiant dimmers, switches, outlets, home automation controls and more.

- Redesigned screwless wall plates feature a lower, more modern profile in keeping with today's design trends.
- Extra 3/8" width and height than standard size wall plates for more tolerance in covering ragged sheet rock openings.
- Provide better sheet rock coverage with standard size appearance.
- Molded of .065" thick polycarbonate.
- One-piece plastic subplate mounts over the device for easy retrofit and lower profile.
- Ideal for residential, multi-dwelling, commercial office and hospitality applications.

Gangable Size	Wall Plate Dimensions	Subplate Dimensions
1 Gang	3.15" x 4.94"	1.81" x 4.78" x .15"
2 Gang	4.96" x 4.94"	3.62" x 4.78" x .15"
3 Gang	6.77" x 4.94"	5.44" x 4.78" x .15"
4 Gang	8.59" x 4.94"	7.25" x 4.78" x .15"
5 Gang	10.40" x 4.94"	9.06" x 4.78" x .15"

Vendor Code: **PAS**

Catalog Number	Color	Carton Quantity	Price Each
<b>SINGLE GANG</b>			
<b>RWP26W</b>	White	6	3.76
<b>TWO GANG</b>			
<b>RWP262W</b>	White	6	6.47
<b>THREE GANG</b>			
<b>RWP263W</b>	White	6	8.65
<b>FOUR GANG</b>			
<b>RWP264W</b>	White	6	10.39

Catalog Numbers Listed Above are White (W). Remove W for Brown or Replace W with BK for Black, GRAY for Gray, I for Ivory, LA for Light Almond or NI for Nickel Metallic Finish.

### TV CABLE OUTLET PLATES STANDARD SIZE (13/32" HOLE)

Vendor Code: **PAS**

Catalog Number	Color	Number Gangable	Ctn. Qty.	Price per 100 pcs.
<b>PLASTIC, BOX MOUNTED</b>				
<b>TP11W</b>	White	1	20	54.06

Catalog Number Listed Above is White (W). Remove W for Brown or Replace W with I for Ivory.

**JUNIOR JUMBO TRADEMASTER STANDARD**

**TRADEMASTER WALL PLATES**

- 3/16" wider and higher than standard size plates
- Unbreakable thermoplastic construction
- Pre-Installed mounting screws on 8, 1 & 26 openings

**JUNIOR JUMBO WALL PLATES**

- 3/8" wider and higher than standard size plates
- The most economical way to cover "goofed-up" wall openings around outlet boxes

### ONE GANG SWITCH PLATES



Vendor Code: **PAS**

Catalog Number	Color	Ctn. Qty.	Price per 100 pcs.
<b>TRADEMASTER THERMOPLASTIC</b>			
<b>TP1W*</b>	White	25	31.39
<b>JUNIOR JUMBO PLASTIC</b>			
<b>TPJ1W*</b>	White	25	45.52
<b>STANDARD SIZE STAINLESS STEEL</b>			
<b>SS1</b>	302 Stainless Steel	25	198.22

\*Catalog Numbers Listed Above are White (W). Remove W for Brown or Replace W with I for Ivory or LA for Light Almond.

### TWO GANG SWITCH PLATES

Vendor Code: **PAS**

Catalog Number	Color	Ctn. Qty.	Price per 100 pcs.
<b>TRADEMASTER THERMOPLASTIC</b>			
<b>TP2W*</b>	White	20	90.90
<b>JUNIOR JUMBO PLASTIC</b>			
<b>TPJ2W*</b>	White	20	105.55
<b>STANDARD SIZE STAINLESS STEEL</b>			
<b>SS2</b>	302 Stainless Steel	20	549.32

\*Catalog Numbers Listed Above are White (W). Remove W for Brown or Replace W with I for Ivory or LA for Light Almond.

### THREE GANG SWITCH PLATES

Vendor Code: **PAS**

Catalog Number	Color	Ctn. Qty.	Price per 100 pcs.
<b>TRADEMASTER THERMOPLASTIC</b>			
<b>TP3W*</b>	White	15	136.54
<b>JUNIOR JUMBO PLASTIC</b>			
<b>TPJ3W*</b>	White	15	158.55
<b>STANDARD SIZE STAINLESS STEEL</b>			
<b>SS3</b>	302 Stainless Steel	15	834.44

\*Catalog Numbers Listed Above are White (W). Remove W for Brown or Replace W with I for Ivory or LA for Light Almond.

### FOUR GANG SWITCH PLATES

Vendor Code: **PAS**

Catalog Number	Color	Ctn. Qty.	Price per 100 pcs.
<b>TRADEMASTER THERMOPLASTIC</b>			
<b>TP4W*</b>	White	10	182.84
<b>STANDARD SIZE STAINLESS STEEL</b>			
<b>SS4</b>	302 Stainless Steel	10	1980.24

\*Catalog Number Listed Above is White (W). Remove W for Brown or Replace W with I for Ivory or LA for Light Almond.

### FIVE GANG SWITCH PLATES

Vendor Code: **PAS**

Catalog Number	Color	Carton Quantity	Price per 100 pcs.
<b>TRADEMASTER THERMOPLASTIC</b>			
<b>TP5W</b>	White	1	766.21

Catalog Number Listed Above is White (W). Remove W for Brown or Replace W with I for Ivory or LA for Light Almond.

### DECORATOR SWITCH PLATES

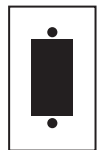

Vendor Code: **PAS**

Catalog Number	Color	Number Gangable	Ctn. Qty.	Price per 100 pcs.
<b>TP26W</b>	White	1	20	44.56
<b>TP262W</b>	White	2	20	88.62
<b>TP263W</b>	White	3	20	133.13
<b>TP264W</b>	White	4	20	182.84

Standard Size Thermoplastic Catalog Numbers Listed Above are White (W). Remove W for Brown or Replace W with BK for Black, I for Ivory or LA for Light Almond.





ONE GANG DUPLEX RECEPTACLE PLATES



Vendor Code: PAS

Catalog Number	Color	Ctn. Qty.	Price per 100 pcs.
<b>TRADEMASTER THERMOPLASTIC</b>			
TP8I	Ivory	25	28.97
TP8W	White	25	28.97
TP8LA	Light Almond	25	28.97
TP8	Brown	25	28.97
TP8BK	Black	25	28.97
<b>JUNIOR JUMBO PLASTIC</b>			
TPJ8I	Ivory	25	53.49
TPJ8W	White	25	53.49
TPJ8LA	Light Almond	25	53.49
TPJ8	Brown	25	53.49
<b>STANDARD SIZE STAINLESS STEEL</b>			
SS8	-	25	198.22

ONE GANG SINGLE RECEPTACLE PLATES



Vendor Code: PAS

Catalog Number	Color	Ctn. Qty.	Price per 100 pcs.
<b>TRADEMASTER THERMOPLASTIC</b>			
TP7I	Ivory	20	54.62
TP7W	White	20	54.62
TP7LA	Light Almond	20	54.62
TP7	Brown	20	54.62
<b>JUNIOR JUMBO PLASTIC</b>			
TPJ7I	Ivory	20	76.06
TPJ7W	White	20	76.06
TPJ7	Brown	20	76.06
<b>STANDARD SIZE STAINLESS STEEL</b>			
SS7	-	20	198.22

WALL PLATE SCREWS



Vendor Code: PAS

Catalog Number	Color	Size	Ctn. Qty.	Price per 100 pcs.
510I	Ivory	6-32" x 1/2"	100	54.66
510W	White	6-32" x 1/2"	100	54.66

BLANK DECOR INSERT

Vendor Code: PAS

Catalog Number	Color	Ctn. Qty.	Price per 100 pcs.
326W	White	5	755.54

Replace the Letters in Black with **GY** for Gray, **A** for Almond or **BK** for Black.

ONE GANG BLANK PLATES

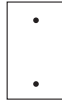

Vendor Code: PAS

Catalog Number	Description	Carton Quantity	Price per 100 pcs.
<b>TRADEMASTER THERMOPLASTIC</b>			
TP13I	Box Ivory	20	54.62
TP13W	Box White	20	54.62
TP13LA	Box Light Almond	20	54.62
TP13	Box Brown	20	54.62
TP14I	Strap Ivory	20	52.55
TP14W	Strap White	20	52.55
TP14LA	Strap Light Almond	20	52.55
TP14	Strap Brown	20	52.55
<b>STANDARD SIZE STAINLESS STEEL</b>			
SS14	Strap 302 SS	20	278.88

TWO GANG BLANK PLATES

Vendor Code: PAS

Catalog Number	Description	Ctn. Qty.	Price per 100 pcs.
<b>TRADEMASTER THERMOPLASTIC</b>			
TP23I	Box Ivory	20	101.99
TP23W	Box White	20	101.99
TP23LA	Box Light Almond	20	101.99
TP23	Box Brown	20	101.99
TP24I	Strap Ivory	20	225.99
TP24W	Strap White	20	225.99
<b>STANDARD SIZE 302 STAINLESS STEEL</b>			
SS23	Strap 302 SS	20	400.67
SS24	Strap Mount	20	1218.00

TWO GANG COMBINATION PLATES SWITCH AND BLANK

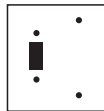

Vendor Code: PAS

Catalog Number	Color	Carton Quantity	Price per 100 pcs.
<b>TRADEMASTER THERMOPLASTIC</b>			
TP113I	Ivory	20	197.63
TP113W	White	20	200.00
TP113LA	Light Almond	20	197.63
TP113	Brown	20	197.63
<b>STANDARD SIZE 302 STAINLESS STEEL</b>			
SS114	-	20	1254.00

TWO GANG COMBO PLATES SWITCH AND DUPLEX RECEPTACLES



Vendor Code: PAS

Catalog Number	Color	Ctn. Qty.	Price per 100 pcs.
<b>TRADEMASTER THERMOPLASTIC</b>			
TP18I	Ivory	20	88.62
TP18W	White	20	88.62
TP18LA	Light Almond	20	88.62
TP18	Brown	20	88.62
<b>JUNIOR JUMBO PLASTIC</b>			
TPJ18I	Ivory	20	105.55
TPJ18W	White	20	105.55
TPJ18LA	Light Almond	20	105.55
TPJ18	Brown	20	105.55
<b>STANDARD SIZE STAINLESS STEEL</b>			
SS18	-	20	549.32

TWO GANG DUPLEX RECEPTACLE PLATES



Vendor Code: PAS

Catalog Number	Color	Carton Quantity	Price per 100 pcs.
<b>TRADEMASTER THERMOPLASTIC</b>			
TP82I	Ivory	20	88.62
TP82W	White	20	88.62
TP82LA	Light Almond	20	88.62
TP82	Brown	20	88.62
<b>JUNIOR JUMBO PLASTIC</b>			
TPJ82I	Ivory	20	105.55
TPJ82W	White	20	105.55
TPJ82LA	Light Almond	20	105.55
TPJ82	Brown	20	105.55
<b>STANDARD SIZE STAINLESS STEEL</b>			
SS82	-	20	549.32

THREE GANG COMBO PLATES 2 SWITCHES AND DUPLEX RECEPTACLE



Vendor Code: PAS

Catalog Number	Color	Carton Quantity	Price per 100 pcs.
<b>TRADEMASTER THERMOPLASTIC</b>			
TP28I	Ivory	20	282.77
TP28W	White	20	282.77
TP28LA	Light Almond	20	282.77
TP28	Brown	20	282.77



## ONE PIECE STEEL SURFACE RACEWAY

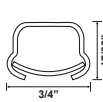
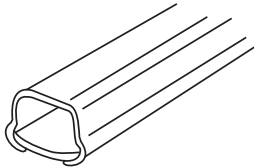

V500  
0.040" STEEL

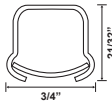

V700  
0.040" STEEL

- Rugged steel raceway. Provides superior strength for any dry location installation.
- Low-profile, unobtrusive appearance. Blends with any decor or setting. Excellent for low-voltage wiring.
- Base and cover are a preassembled one-piece unit. Facilitates easy installation and provides excellent security. ScuffCoat finish. Tough, durable, scratch-resistant finish which can be overpainted with latex paint.
- Surface mounting. Eliminates disturbing the building structure or wall finish to make renovations easy.
- Full line of fittings. Provides unlimited wiring solutions and interconnection between raceway systems.
- More choice of colors. 700 Series Raceway and Fittings are available in ivory and white.
- Fittings have removable covers. Allows easy access to wiring for changes and additions.
- Raceway cutters with replaceable blades. Cuts raceway cleanly, reduces labor, and installation time.
- Datacom connectivity options. Accepts industry standard and proprietary devices from a wide range of manufacturers to provide a seamless and aesthetically pleasing interface for voice, data, audio, and video applications at the point of use.
- UL5 and ADA compliant. Raceway and fittings meet UL5 specifications and can be installed in conformance with ADA requirements.

Vendor Code: **WIR**

Catalog Number	Capacity	Price per 100 pcs.
V500	(2) #6 - (10) #14	136.24
V700	(2) #6 - (11) #14	151.67

Available in Ivory Only

## FITTINGS FOR WIREMOLD V500 & V700

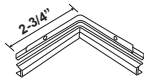

V517 or V717

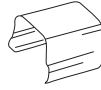

V506 or V706

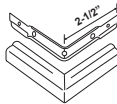

V518 or V718



V504 or V704

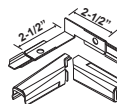

V5711LH  
or V5711RH

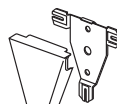

V5715

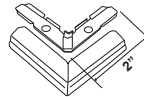

V511 or V711

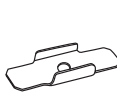

V5703

Vendor Code: **WIR**

Catalog Number	Description	Price per 100 pcs.
V504	1 or 2 Hole Strap	38.18
V506	Connector Cover	56.00
V511	90° Flat Elbow	196.00
V517	Internal Elbow	243.83
V518	External Elbow	225.16
V704	1 or 2 Hole Strap	59.80
V706	Connection Cover	63.35
V711	90° Flat Elbow	207.66
V717	Internal Elbow	282.34
V718	External Elbow	247.34
V5703	Supporting Clip	54.80
V5711LH	Int. Twisted Elbow	516.66
V5711RH	Int. Twisted Elbow	516.66
V5715	Tee Fitting	471.34

Available in Ivory Only  
V57 Fits V500 and V700

## BOXES FOR WIREMOLD V500 & V700



V5719

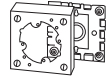

V5735



V5737, V5738,  
V5738A or  
V5739A

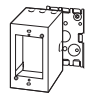

V5744 or  
V57442

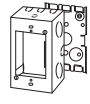

V5745

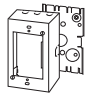

V5747 or  
V57472

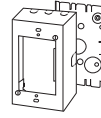

V5748 or  
V5748S

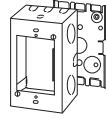

V5751 or  
V57513

Vendor Code: **WIR**

Catalog Number	Description	Price per 100 pcs.
V5719	Corner Box	1763.21
V5735	Distribution Box	1477.34
V5737	Extension Box	1353.33
V5738	Fixture Box	1261.17
V5738A	Fixture Box - 1"	1284.50
V5739A	Extension Box - 2-3/4"	1626.98
V5744	SW & Recept. Box - 2-3/4"	2019.50
V57442*	SW & Recept. Box - 2-3/4"	2541.00
V5745	SW & Recept. Box - 1-3/4"	863.33
V5747	SW & Recept. Box - 1-3/8"	702.34
V57472	SW & Recept. Box - 1-3/8"	1365.00
V5748	SW & Recept. Box - 1-3/4"	849.33
V5748S	SW & Recept. Box - 1-15/16"	731.50
V5751	Flush Type Adapter	758.33

Available in Ivory Only  
\*2 Gang Box



**B**  
Wiring Devices

**ONE PIECE LATCHING  
NON-METALLIC SURFACE RACEWAY  
(300 VOLT RATED)**

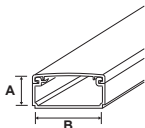

Vendor Code: **WIR**

Catalog Number	A	B
<b>PN03L08FW</b>	1/2"	13/16"
<b>PN05L08FW</b>	5/8"	1-1/8"
<b>PN10L08FW</b>	13/16"	1-11/16"

- Easy to align. All base and fittings have unique alignment guides built in to help avoid unsightly gaps and uneven installations. All fitting covers have 1/4" overlap to hide uneven cuts of raceway.
- Ceiling fitting clips over suspended ceiling grid. Saves time and labor by eliminating the need to cut metal ceiling grid.
- Pre-punched mounting holes. Faster and easier installation.
- Ratings: 600V
- Datacom Connectivity Options. Accepts industry standard and proprietary devices from a wide range of manufacturers to provide a seamless and aesthetically pleasing interface for voice, data, audio, and video applications at the point of use.

Vendor Code: **WIR**

Catalog Number	Description	Price per Foot
<b>PN03L08FW</b>	Capacity: (7) #12 - (8) #14	2.19
<b>PN05L08FW</b>	Capacity: (14) #12 - (16) #14	2.42
<b>PN10L08FW</b>	Capacity: (19) #10 - (20) #12 - (22) #14	3.31

Sold in Eight Foot Lengths

**NON-METALLIC SURFACE RACEWAY BOXES  
(300 VOLT RATED)**

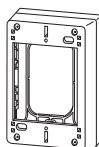

PSB1FW

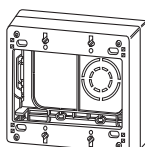

PSB2FW

**PSB1** - Accepts all standard single-gang NEMA faceplates and keystone jacks. Twistouts on all four sides for PN03, PN05, and PN10 series Raceways. Designed for use with Ortronics® WiJack™ Wireless Access Point.

**PSB2** - Accepts all standard two-gang NEMA faceplates and keystone jacks. Twistouts on all four sides for PN03, PN05, and PN10 series Raceways. Has 1/2" and 3/4" concentric trade size KOs, as well as rectangular KO for wall box mounting. Designed for use with Ortronics® WiJack™ Wireless Access Point.

Vendor Code: **WIR**

Catalog Number	Description	Price Each
<b>PSB1FW</b>	One Gang Device Box	6.97
<b>PSB2FW</b>	Two Gang Device Box	10.97

The Catalog Numbers Listed Above are Fog White (**FW**). Replace **FW** with **V** for Ivory or **WH** for White.

**NON-METALLIC SURFACE  
RACEWAY FITTINGS  
(300 VOLT RATED)**

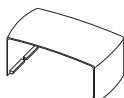

Cover Clip

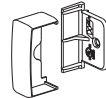

Blank End Fitting

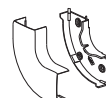

90° Flat Elbow

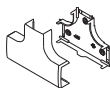

Tee



Internal Elbow



External Elbow

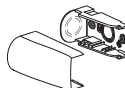

Entrance End Fitting

Vendor Code: **WIR**

Catalog Number	Description	Price Each
<b>FITTINGS FOR PN03 SERIES</b>		
<b>PN03F06FW</b>	Cover Clip	1.22
<b>PN03F20FW</b>	Blank End Fitting	1.64
<b>PN03F11FW</b>	90° Flat Elbow	1.69
<b>PN03F15FW</b>	Tee	2.39
<b>PN03F17FW</b>	Internal Elbow	1.69
<b>PN03F18FW</b>	External Elbow	1.69
<b>PN10F21FW*</b>	Entrance End Fitting	4.65
<b>FITTINGS FOR PN05 SERIES</b>		
<b>PN05F06FW</b>	Cover Clip	1.56
<b>PN05F20FW</b>	Blank End Fitting	1.78
<b>PN05F11FW</b>	90° Flat Elbow	1.78
<b>PN05F15FW</b>	Tee	2.51
<b>PN05F17FW</b>	Internal Elbow	1.78
<b>PN05F18FW</b>	External Elbow	1.78
<b>PN10F21FW*</b>	Entrance End Fitting	4.65
<b>FITTINGS FOR PN10 SERIES</b>		
<b>PN10F06FW</b>	Cover Clip	3.12
<b>PN10F11FW</b>	90° Flat Elbow	1.96
<b>PN10F15FW</b>	Tee	2.76
<b>PN10F17FW</b>	Internal Elbow	1.96
<b>PN10F18FW</b>	External Elbow	1.96
<b>PN10F21FW</b>	Entrance End Fitting	4.65

\*Includes Reducer Adaptor for Use with PN03 and PN05 Series Raceway



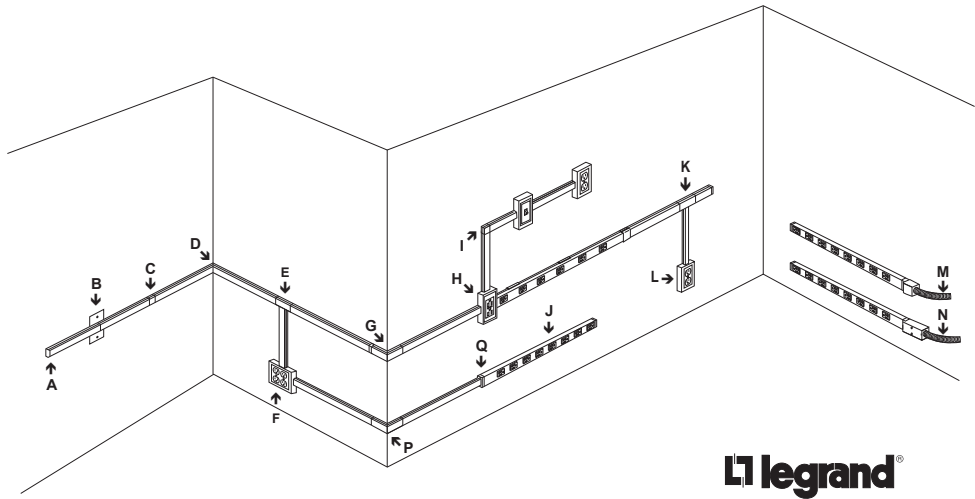

B  
Wiring Devices

**STEEL TWO PIECE RACEWAY**

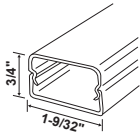

Vendor Code: **WIR**

Catalog Number	Color	Price per Foot
<b>V2000BC</b>	Ivory	2.97

Catalog Numbers Listed Above are Ivory. Replace V with G for Gray. Includes Base and Cover.

**PLUGMOLD 2000 WIRED SECTIONS**

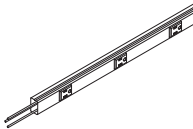

Vendor Code: **WIR**

Catalog Number	Length	Outlets Ctr.	Qty.	Price Each
<b>3-WIRE, 1-CIRCUIT</b>				
<b>V20GB306</b>	3'	6"	6	42.39
<b>V20GB506</b>	5'	10"	6	63.80
<b>V20GB512</b>	5'	12"	5	46.00
<b>V20GB606</b>	6'	6"	12	72.91
<b>V20GB612</b>	6'	12"	6	54.73
<b>V20GB618</b>	6'	18"	4	46.26

Catalog Numbers Listed Above are Ivory. Replace V with G for Gray.

**2000 SERIES STEEL RACEWAY FITTINGS**

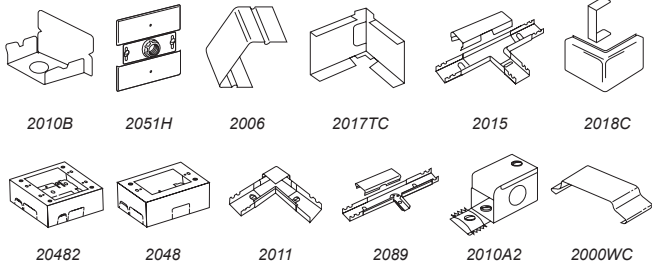

Vendor Code: **WIR**

Catalog Number	Description	Diagram	Price per 100 pcs.
<b>V2010B</b>	Blank End	A	100.33
<b>V2051H</b>	Flush Plate Adap	B	1146.84
<b>V2006</b>	Cover Clip	C	134.17
<b>20177TC</b>	Internal Corner Coupling	D	248.50
<b>V2015</b>	Tee	E	1615.84
<b>V20482</b>	Two-Gang Box	F	2558.50
<b>V2018C</b>	External Elbow	G	486.50
<b>V2048</b>	Single Gang Box	H	1117.66
<b>V2011</b>	90° Flat Elbow	I	617.17
<b>V2089</b>	Side Reducing Connector	K	1561.00
<b>V5748</b>	Single Gang Box 500 Series	L	849.33
<b>V2010A2</b>	**Entrance End Ivory 1/2"	M	733.83
<b>V2010A3</b>	**Entrance End 3/4"	N	1768.33
<b>V2089E</b>	End Reducing Connector	O	565.84
<b>2000WC</b>	Wire Clip Coupling	N/A	60.76
<b>V2003</b>	Support Clip	N/A	168.00
<b>2009</b>	Ground Clamp	N/A	617.17

Catalog Numbers Listed Above are Ivory. Replace V with G for Gray. \*1/2" Trade Size KO's on All Sides \*\*3/4" Trade Size KO's on Bottom and Rear, 1/2" on Other Sides



Two Piece Raceway · Pancake Overfloor Raceway · Fittings · Tele-Power Poles

B

Wiring Devices

**TWO PIECE RACEWAY**  
G3000



G3000B

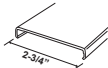

G3000CE

Vendor Code: **WIR**

Catalog Number	Description	Color	Price per 100 pcs.
<b>G3000B</b>	10' Base	Gray	373.33
<b>G3000CE</b>	5' Cover	Gray	193.66

Catalog Numbers Listed Above are Gray (G). Replace G with I for Ivory.

**FITTINGS FOR G4000**



G4000WC



4001A

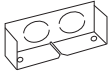

G4010B

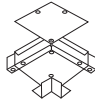

G4011

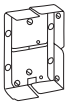

G4017

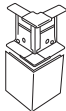

G4018

Vendor Code: **WIR**

Catalog Number	Description	Price per 100 pcs.
<b>G4000WC</b>	Wire Clip (Plated)	250.00
<b>4001A</b>	Steel Coupling Fittings	593.38
<b>G4010B</b>	Blank End (Has Two 1/2" Trade Size KOs.)	719.00
<b>G4011</b>	Gray Flat Elbow Fitting	2826.53
<b>G4017</b>	Internal Elbow	1825.00
<b>G4018</b>	External Elbow	3927.61



**STEEL PANCAKE®**  
**OVERFLOOR RACEWAY**  
**AND FITTINGS**

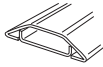

1500



1500WC or 2600WC

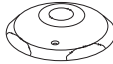

1542D or 2642D



1511 or 2611

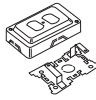

1546B

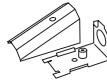

1585



656

Pancake Overfloor Steel Raceway is ideal for open space wiring of workstations and desk areas in high traffic sites. Both the 1500 and 2600 Series Raceways mount directly to the floor and provide safe load bearing strength for normal office use.

Both raceway models offer a full complement of fittings and device boxes for power and communication wiring. Pancake Overfloor Raceway comes unpainted with a paintable galvanized finish.

Vendor Code: **WIR**

Catalog Number	Description	Price per 100 pcs.
<b>150010</b>	Capacity (2)#8-(10)#14	254.70
<b>1500 ACCESSORIES</b>		
<b>1500WC</b>	Wire Clip	93.80
<b>2600WC</b>	Wire Clip	92.80
<b>1511</b>	90° Flat Elbow	738.11
<b>1542D</b>	Junction Box	1312.09
<b>1546B</b>	Duplex Receptacle Box	1951.94
<b>1585</b>	Combination Connector	917.90
<b>656</b>	Cover Removal Tool	2039.67

Unpainted Galvanized Steel Finish

**TELE-POWER POLES**



Vendor Code: **WIR**

Catalog Number	Length	Number and Type of Outlets	Price Each
<b>POWER POLES</b>			
<b>25DTP4</b>	10' 5"	2 Duplex	152.63
<b>25DTP412</b>	12' 5"	2 Duplex	191.90
<b>25DTP415</b>	15' 15"	2 Duplex	246.87

Only Available in Ivory  
Duplex Receptacles are 20A and 125V

**FLEXIBLE PANCAKE**  
**OVERFLOOR CABLE**  
**PROTECTION SYSTEM**

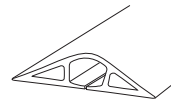

Vendor Code: **WIR**

Catalog Number	Color	Length	Price per 100 pcs.
<b>BK140010</b>	Black	10'	218.23
<b>BR140010</b>	Brown	10'	218.23

Replace the Catalog Numbers in Black with **BE** for Beige or **GR** for Gray.



**Lighting & Lighting Controls**

**SECTION**



**Lighting & Lighting Controls**

## Lighting &amp; Lighting Controls

## Cooper Lighting Solutions Fixtures

LED Lay-ins, Flat Panels, Strip Lights, Wrap	
Arounds.....	C4
LED Vaportite.....	C4
LED Surface Mount, Disk Lights.....	C5
LED Recessed Trims, Gimbals.....	C5
LED Recessed Housings.....	C6
Traditional Recessed Housings & Trims.....	C6-C7
LED Floodlights.....	C8
LED High Bays.....	C8
LED Wall Packs.....	C8
LED Wall Lights, Area Lights, Security Floods.....	C9
LED Emergency Lighting.....	C10
LED Undercabinet.....	C10
LED Bluetooth Shoplight.....	C10
Traditional Troffers, Strip Lights, Wrap	
Arounds.....	C11
Traditional Vaportight.....	C11
Traditional High Bays.....	C11
Traditional Undercabinet.....	C11

## Lithonia Lighting Fixtures

LED Lay-ins, Flat Panels, Strip Lights, Wrap	
Arounds.....	C12
LED Vaportite.....	C13
LED Shoplight.....	C13
LED High Bays.....	C13
LED Downlights.....	C14
LED Undercabinet.....	C14
LED Emergency Lighting.....	C14
LED Vaporproof.....	C14
LED Wall Packs.....	C15
LED Floodlights.....	C15
LED Area Lights.....	C15
Traditional Troffers, Strip Lights, Wrap Arounds.....	C16
Traditional High Bays.....	C16

## RAB Products

LED Floodlights, Area Lights.....	C17
Poles.....	C17
LED High Bays.....	C18
LED Wall Packs, Garage Lights.....	C18
LED Washdowns.....	C18
Traditional Wall Packs.....	C18
LED Compact Floodlights, Spotlights.....	C19
LED Wrap Arounds.....	C19
LED Vaporproof.....	C19
Mighty Posts.....	C19
LED Lamps.....	C20

## Lamp Accessories

Lamp Accessories.....	C21
Temporary Lighting.....	C21

## GE Lamps

LED Tubes.....	C22
LED A-Line, PAR, Reflector.....	C22
LED HID Replacements.....	C23
LED CFL Plug-in Replacements.....	C23
LED Decorative.....	C23
LED Compact PAR.....	C24
LED Directional.....	C24
LED Candle, Vintage.....	C24
Traditional A-Line, PAR, Reflector.....	C25
Traditional Exit Sign, Quartz, Appliance.....	C25
Traditional Halogen.....	C25
Traditional Tubes.....	C26

## GE Lamps (Continued)

Metal Halide.....	C27
High Pressure Sodium.....	C27
Biax.....	C27

## Sylvania Lamps

LED A-Line, PAR.....	C28
LED Tubes.....	C28
LED Reflector, MR16.....	C29
LED Filament, Vintage.....	C29
LED HID Replacements.....	C30
LED U-Shaped, TT5, Pin Base.....	C30
Traditional: A-Line, PAR, Reflector.....	C31
Traditional: Halogen, Decorative.....	C31
Traditional Tubes.....	C31
Metal Halide.....	C32
High Pressure Sodium.....	C32
Biax.....	C32
Traditional U-shaped, Circline, T5.....	C32

## Keystone Products

LED Tubes.....	C33
LED Strips.....	C33
LED HID Replacement.....	C34
LED PLL, CFL Replacement.....	C34
LED High Bay Replacement.....	C34
LED A-Line, PAR, Reflector, MR16.....	C35
LED Decorative.....	C35

## Tape Lights

LED Tape Lights.....	C36
----------------------	-----

## Ballasts &amp; Drivers

Ballasts.....	C37
Programmable Drivers.....	C37

## Satco Lamps

LED HID Replacements.....	C38
LED Filament.....	C38
LED PAR, Reflector.....	C38
LED Miniature Lamps.....	C38

## Lutron Products

Dimmers, Fan Controls.....	C39
Sensors.....	C40
Vive Hubs.....	C40
Radio Powr Wireless Sensors.....	C40
RF Receptacles.....	C40
Maestro Wireless, Powpak Controls.....	C41
Remote Controlled Shades.....	C41
Vive Wireless.....	C41
Ra2 Products.....	C42
Caseta Wireless.....	C42

## Tork Products

Photocontrols.....	C43
Time Clocks.....	C44

## Builder Products

Fan Units.....	C45
Chime Kits.....	C45
Smoke Alarms.....	C46
Area Heaters.....	C46
Vinyl Ducting.....	C46





# Lighting Showroom



C  
Lighting & Lighting Controls

In the Lighting Showroom, we have some of the most knowledgeable lighting specialists in East Texas, and no one can beat our total value of service and price. Located in Nacogdoches, Texas, we offer the highest level of service and appreciation for every sale from a simple lightbulb to a large lighting project.

With our up-to-date lighting knowledge, the Lighting Showroom can help you find the right light for any space. Our mission is to provide customers of Elliott Electric Supply the best buying experience as well as the latest information in lighting and lighting products.

### What We Offer

The Lighting Showroom offers the widest array of lighting options in the area and we are ready to help with all of your lighting needs, whether it's a remodel or new construction. Come in or contact us today to learn how we can help you save!

- Free lighting design and consultations
- Free delivery based on your location.
- Discount prices for building contractors and whole home orders

### Online Showroom



### Contact Us

Elliott Electric Supply  
Lighting Showroom  
2310 N. Stallings Dr.  
Nacogdoches, TX  
75964

(936) 569-7941

LED LAY-INS

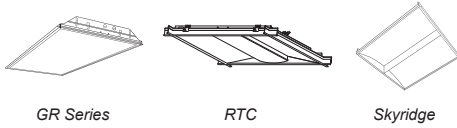

GR Series

RTC

Skyridge

The GR Series is a recessed lensed LED troffer optimal performance and energy efficiency compatible with all of today's popular ceiling systems and is available with a number of shielding options and accessories.

The RTC lensed troffer series provides performance, reliability and flexibility with a housing optimized for shallow plenums. These center illuminated troffers provide numerous options for color, lumens, controls and sensing.

The SkyRidge™ Series offers an aesthetically pleasing, yet affordable LED alternative to fluorescent fixtures. WaveStream™ technology provides unmatched optical performance, efficiency and unique visual style.

Vendor Code: **ETL**

Catalog Number	Lumens	Kelvin	Watts	Size	Price Each
<b>GR SERIES</b>					
<a href="#">22GR3240D</a>	3,200	4,000K	33	2' x 2'	74.45
<a href="#">24GR4240D</a>	4,200	4,000K	37	2' x 4'	96.89
<b>RTC</b>					
<a href="#">22RTC3440</a>	3,523	4,000K	29	2' x 2'	104.94
<a href="#">24RTC4840</a>	4,775	4,000K	38	2' x 4'	119.79
<b>SKYRIDGE</b>					
<a href="#">22SRLD229CUNVL84</a>	2,900	4,000K	23.4	2' x 2'	188.33
<a href="#">24SRLD248CUNVL84</a>	4,800	4,000K	38.2	2' x 4'	196.15

Other Color Temperatures are Available. Replace the Black Numbers with **35** for 3,500K or **40** for 4,000K.

LED FLAT PANELS

PANEL LED PANEL SERIES



FPanel LED panel series provide premium performance and pleasing aesthetics. The luminaire is optimized for shallow plenum grid ceilings but may also be surface or suspension mounted. These panels are ideal for both new construction and renovation of existing fluorescent troffers. The panel's refined visual optics and integrated grid retention clips provide the features needed for installation, speed and flexibility. LED FPanels are an excellent lighting solution for commercial office spaces, schools, healthcare facilities and retail merchandising areas.

Vendor Code: **ETL**

Catalog Number	Lumens	Color	Watts	Size	Price Each
<a href="#">22FP3240C*</a>	3,560	4,000K	30	2' x 2'	57.80
<a href="#">24FP4740C*</a>	4,858	4,000K	40	2' x 4'	78.57
<b>FLAT PANEL SURFACE MOUNTING KITS</b>					
<a href="#">FPSURF22</a>	2' x 2' Mounting Kit				33.09
<a href="#">FPSURF24</a>	2' x 4' Mounting Kit				40.44

\*Replace **40** with **35** for 3,500K or **50** for 5,000K.

LED STRIP LIGHTS  
ST2 STRIP SERIES

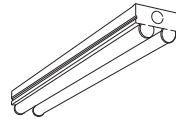

Vendor Code: **ETL**

Catalog Number	Length	Lumens	Color	LPW	Price Each
<a href="#">2ST2L2040R</a>	2'	2,298	4,000K	121	46.58
<a href="#">4ST2L4040R</a>	4'	4,433	4,000K	114	81.81

Only Available in 4,000K

LED CLASSIC WRAP AROUNDS  
WNLED SERIES

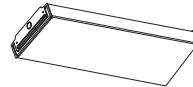

Vendor Code: **ETL**

Catalog Number	Length	Lumens	Color	LPW	Price Each
<a href="#">4WNLEDL440SLFUN</a>	4'	4,062	4,000K	113	118.97

2' Lengths Also Available.  
Also Available in 3,000K, 3,500K and 5,000K.

LED WRAP AROUNDS  
CWPLD SERIES



Vendor Code: **ETL**

Catalog Number	Length	Lumens	Color	LPW	Price Each
<a href="#">4CWPLD4040C</a>	4'	4,200	4,000K	92	109.97

VAPORTITE LED SERIES

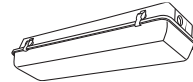

Vendor Code: **ETL**

Catalog Number	Length	Lumens	Color	LPW	Price Each
<a href="#">4VT2LD46DRUNVL84</a>	4'	6,000	4,000K	105	285.59

Other Color Temperatures are Available. Replace the Black Number with **3** for 3,000K and **5** for 5,000K.





## LED Products (Surface Mount · Ultra Thin Downlights · Retrofit Adjustable Gimbals)



### LED SURFACE MOUNT BLD SERIES



BLD606930WH



BLD406930WH

Vendor Code: **ETL**

Catalog Number	Size	CRI	Color	Lumens	LPW	Price Each
<b>BLD606930WHHR</b>	6"	90	3,000K	700	85	18.43
<b>BLD406930WHHR</b>	4"	90	3,000K	690	84	29.47

Other Color Temperatures are Available. Replace the Two Black Numbers with **27** for 2,700K, **40** for 4,000K, or **50** for 5,000K.



### LED DISK LIGHT

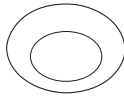

Vendor Code: **ETL**

Catalog Number	Size	Watts	Color	Lumens	CRI	Price Each
<b>HLC6099301EWH12X</b>	6"	15	3,000K	900	92	9.49
<b>HLC4079301EWH12X</b>	4"	15	3,000K	750	92	9.49

Also Available in 4,000K and 5,000K.



### ULTRA THIN LED DOWNLIGHT FIELD SELECTABLE CCT

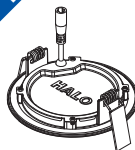

HLB and Connector  
(Round)

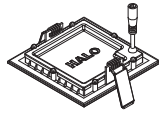

HLB and Connector  
(Square)

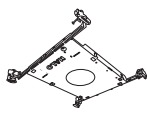

New Construction  
Mounting Frames

• The SeleCCTable technology puts flexibility at your fingertips. By using the switch located on the driver junction box, the user can choose from a range of five color temperatures 2,700K - 5,000K.

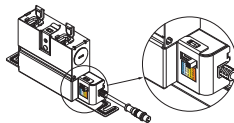

Vendor Code: **ETL**

Catalog Number	Size	CRI	Color	Lumens	LPW	Price Each
<b>ROUND</b>						
<b>HLB6099FS1EMWR</b>	6"	90	2,700K-5,000K	1,061	66	24.62
<b>HLB4069FS1EMWR</b>	4"	90	2,700K-5,000K	723	60	25.35
<b>SQUARE</b>						
<b>HLB6S099FS1EMWR</b>	6"	90	2,700K-5,000K	975	71	28.57
<b>HLB4S069FS1EMWR</b>	4"	90	2,700K-5,000K	696	69	28.57
<b>MOUNTING FRAMES TO RESERVE SPACE</b>						
<b>HL6NCMF</b>	6"	New Construction Mounting Frame				5.97
<b>HL4NCMF</b>	4"	New Construction Mounting Frame				5.19

Lumens and LPW Data is Based on 3,000K Selection  
Direct Mount - Does Not Require Recessed Housing or Junction Box

### LED RECESSED RETROFIT TRIMS DIMMABLE LED MODULES

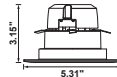

LT460WH6930

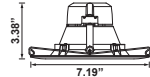

LT560WH6930

Vendor Code: **ETL**

Catalog Number	CRI	Color	Lumens	LPW	Price Each
<b>4" LED RETROFIT DOWNLIGHT</b>					
<b>LT460WH6930R</b>	90	3,000K	554	69.25	16.99
<b>5" OR 6" LED RETROFIT DOWNLIGHT</b>					
<b>LT560WH6930R</b>	90	3,000K	683	68.3	12.16

Other Color Temperatures are Available. Replace the Two Black Numbers with **27** for 2,700K, **30** for 3,000K, **40** for 4,000K, or **50** for 5,000K.

### LED RETROFIT ADJUSTABLE GIMBALS

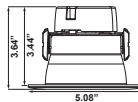

LA4069301EWH

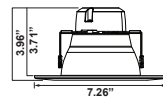

LA56069301EWH

Vendor Code: **ETL**

Catalog Number	CRI	Color	Lumens	LPW	Price Each
<b>4" LED RETROFIT ADJUSTABLE GIMBAL</b>					
<b>LA4069301EWH</b>	90	3,000K	613	71	26.39
<b>RA406930WHHR *</b>	90	2,700K - 5,000K	615	88	68.74
<b>5 OR 6" LED RETROFIT ADJUSTABLE GIMBAL</b>					
<b>LA56069301EWH</b>	90	3,000K	637	73	26.39
<b>RA5606930WHHR *</b>	90	2,700K - 5,000K	670	90	65.88

\*Field Selectable Color Temperatures are 2,700K, 3,000K, 3,500K, 4,000K, or 5,000K. Specs listed are based on 3,000K.

### 120V LED SURFACE MOUNT

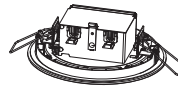

Round Direct Mount

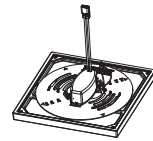

Square Non-Direct Mount

Vendor Code: **ETL**

Catalog Number	Shape	Size	CRI	Color	Lumens	LPW	Price Each
<b>INSTALLS IN RECESSED HOUSINGS OR JUNCTION BOX</b>							
<b>SMD6R6930WH</b>	Round	6"	92	3,000K	758	79	29.69
<b>SMD6S6930WH</b>	Square	6"	92	3,000K	790	80	29.69
<b>SMD4R6930WH</b>	Round	4"	93	3,000K	700	72	27.08
<b>SMD4S6930WH</b>	Square	4"	92	3,000K	790	80	27.08
<b>DIRECT MOUNT W/CLIPS (NO HOUSING OR JUNCTION BOX REQUIRED)</b>							
<b>SMD6R6930WHDM</b>	Round	6"	92	3,000K	758	79	32.16
<b>SMD6S6930WHDM</b>	Square	6"	92	3,000K	790	80	32.16
<b>SMD4R6930WHDM</b>	Round	4"	93	3,000K	700	72	32.16
<b>SMD4S6930WHDM</b>	Square	4"	92	3,000K	790	80	32.16

Other Color Temperatures are Available. Replace the Two Black Numbers with **27** for 2,700K, **40** for 4,000K, or **50** for 5,000K.  
Junction Box Must be 2-1/8" Deep.



LED Recessed Housings · Shallow Downlight Housings · Recessed Trims

LED 6" RECESSED HOUSINGS

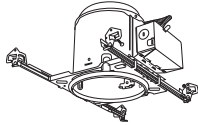

E750ICAT

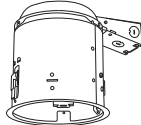

E750RICAT

Vendor Code: **ETL**

Catalog Number	Description	Price Each
<b>E750ICAT</b>	20W Max, Airtight Insulation Contact	8.79
<b>REMODEL HOUSINGS</b>		
<b>E750RICAT</b>	20W Max, Airtight Insulation Contact	9.69

LED 4" RECESSED HOUSINGS

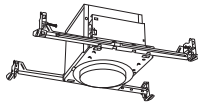

H995ICAT

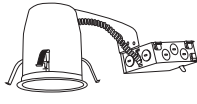

H995RICAT

Vendor Code: **ETL**

Catalog Number	Description	Price Each
<b>H995ICAT</b>	15W Max, Airtight Insulation Contact	20.79
<b>REMODEL HOUSINGS</b>		
<b>H995RICAT</b>	15W Max, Airtight Insulation Contact	24.85

4" HOUSINGS AND TRIMS FOR LED MR16 LAMPS

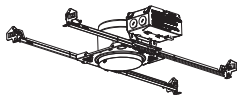

E44MR16ICAT

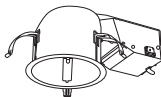

E44MR16RICAT

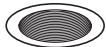

1431WBWF



1432MWWF



1433MWWF

Vendor Code: **ETL**

Catalog Number	Description	Price Each
<b>E44MR16ICAT</b>	10W Max, Airtight Insulation Contact	35.19
<b>REMODEL HOUSINGS</b>		
<b>E44MR16RICAT</b>	10W Max, Airtight Insulation Contact	29.78
<b>4" TRIMS FOR LED MR16 HOUSINGS</b>		
<b>1431WBWF</b>	Conical Baffle, White Trim Ring with White Baffle	9.23
<b>1432MWWF</b>	Angle Cut Reflector with Lens Wall Wash, White	15.38
<b>1433MWWF</b>	Conical Reflector with Diffuse Lens, White	13.85

6" RECESSED INCANDESCENT OR LED

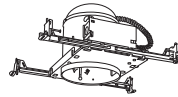

New Construction

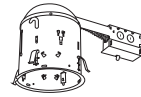

Remodel

Vendor Code: **ETL**

Catalog Number	Description	Carton Quantity	Price Each
<b>E77TAT</b>	150W Max., Airtight No Insulation Contact	6	12.97
<b>E71CAT</b>	90W Max, Airtight Insulation Contact	6	12.53
<b>REMODEL HOUSINGS</b>			
<b>E77RTAT</b>	150W Max., Airtight No Insulation Contact	6	13.19
<b>E77RICAT</b>	90W Max., Airtight Insulation Contact	6	12.75

Popular Fixtures Indicated in Bold.

6" SHALLOW DOWNLIGHT HOUSINGS

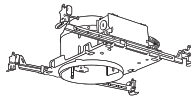

New Construction

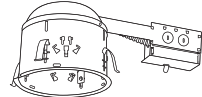

Remodel

Vendor Code: **ETL**

Catalog Number	Description	Carton Quantity	Price Each
<b>E27TAT</b>	100W Max., Airtight No Insulation Contact	6	17.97
<b>E27ICAT</b>	75W Max., Airtight Insulation Contact	6	16.78
<b>REMODEL HOUSINGS</b>			
<b>E27RTAT</b>	75W Max., Airtight No Insulation Contact	6	11.94
<b>E27RICAT</b>	75W Max., Airtight Insulation Contact	6	11.32

6" RECESSED TRIMS



70PS

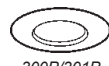

300P/301P

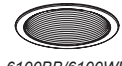

6100BB/6100WB



401P



6101BB/6101WB



6106SC

Vendor Code: **ETL**

Catalog Number	Description	Price Each
<b>70PS</b>	Albalite Lens Shower Light, White Trim	18.14
<b>300P</b>	Open, White Trim, Socket Bracket	6.04
<b>301P</b>	White Open Trim	5.19
<b>6100BB</b>	White Trim with Black Metal Baffle	5.07
<b>6100WB</b>	White Metal Trim Ring and White Baffle	5.07
<b>401P</b>	White Open Trim	6.28
<b>6101BB</b>	Black Metal Baffle with White Trim (Narrow and Wide)	5.31
<b>6101WB</b>	White Metal Baffle with White Trim (Narrow and Wide)	5.07
<b>6103BB</b>	Black Metal Baffle with White Trim	4.98
<b>6103WB</b>	White Metal Baffle with White Trim	4.98
<b>6106SC</b>	White Self-Flange Trim, Clear Specular Reflector	11.61
<b>6110WB</b>	White Perflex Baffle, White Self-Flange Trim	5.80

Popular Fixtures Indicated in Bold.



Recessed Housings · Low Voltage Downlight Housings

6" RECESSED HOUSINGS AND TRIMS  
NO SOCKET BRACKET

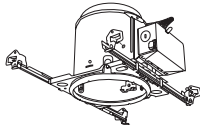

E7ICATNB



6130WH



6125BB  
or 6125WB



6150WH

Vendor Code: ETL

Catalog Number	Description	Price Each
<b>E7ICATNB</b>	90W Max., Airtight Insulation Contact	10.99
<b>SOCKET SUPPORTING TRIMS FOR HOUSINGS</b>		
<b>6130WH</b>	White Adjustable Eyeball	14.03
<b>6125BB</b>	White Self-Flange Trim Ring and Black Baffle	7.19
<b>6125WB</b>	White Self-Flange Trim Ring and White Baffle	7.19
<b>6150WH</b>	Frost Dome Lens Shower Light, White Trim	13.30

Popular Fixtures Indicated In Bold.

4" DOWNLIGHT HOUSINGS AND TRIMS

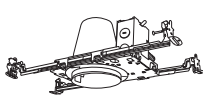

E4TATSB

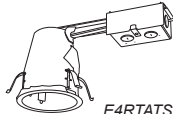

E4RTATSB



4001BB or 4001WB



4002WH

Vendor Code: ETL

Catalog Number	Description	Price Each
<b>5-1/2" NEW CONSTRUCTION</b>		
<b>E4TATSB</b>	50W Max., Airtight No Insulation Contact	15.39
<b>5-1/2" REMODEL HOUSINGS</b>		
<b>E4RTATSB</b>	50W Max., Airtight No Insulation Contact	15.94
<b>5-7/8" HOUSINGS</b>		
<b>E4ICATSB</b>	50W Max., Airtight Insulation Contact	19.79
<b>TRIMS FOR 4-1/2" HOUSINGS</b>		
<b>4001BB</b>	Plastic Step Baffle, White Trim Ring with Black Baffle	7.98
<b>4001WB</b>	Plastic Step Baffle, White Trim Ring with White Baffle	7.98
<b>4002WH</b>	Eyeball - 30° Tilt, White Trim Ring with White Eyeball	22.37

Popular Fixtures Indicated In Bold.

SLOPED CEILING RECESSED INCANDESCENT  
DOWNLIGHT HOUSINGS AND TRIMS

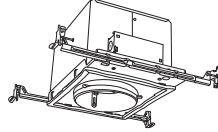

H645IC



498P



78P



456W



170PS

Vendor Code: ETL

Catalog Number	Description	Price Each
<b>HOUSINGS 6-1/2" DIAMETER, 7-3/8" DEPTH</b>		
<b>H645IC</b>	AIR-TITE™ Sealed, 2/12-12/12 Pitch	65.71
<b>TRIMS FOR H645IC</b>		
<b>456W</b>	White Trim with White Coilex Baffle	64.12
<b>456P</b>	White Trim with Black Coilex Baffle	67.03
<b>HOUSINGS 5-1/4" DIAMETER, 6-1/2" - 8-3/4" ADJUSTABLE DEPTH</b>		
<b>H47ICAT</b>	AIR-TITE™ Insulation Contact, 2/12-12/12 Pitch	44.98
<b>TRIMS FOR H47ICAT</b>		
<b>498P</b>	White Trim with Black Baffle	44.97
<b>78P</b>	Eyeball - 30° Tilt, White Trim with White Eyeball	21.29
<b>170PS</b>	White Trim with Frosted Albalite Lens	26.59

Popular Fixtures Indicated in Bold.

4" LOW VOLTAGE DOWNLIGHT HOUSINGS  
WITH INTEGRAL TRANSFORMER



H1499ICAT



H1499RTAT



1420P



1421C

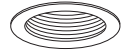

1493W

Vendor Code: ETL

Catalog Number	Description	Price Each
<b>4-1/2" DIAMETER, 7-1/4" DEEP, NEW CONSTRUCTION HOUSINGS</b>		
<b>H1499ICAT</b>	Airtight Insulation Contact	61.47
<b>4-1/2" DIAMETER, 7-1/4" DEEP, REMODEL HOUSINGS</b>		
<b>H1499RTAT</b>	Airtight, No Insulation Contact	60.50
<b>TRIMS FOR LOW VOLTAGE HOUSINGS</b>		
<b>1420P</b>	White Trim, Adjustable Slot Aperture, 35° Tilt	24.29
<b>1421C</b>	White Trim w/Clear Specular Reflector, 35° Tilt	45.74
<b>1493W</b>	White Trim w/Black Foilex Baffle, 35° Tilt	20.83

Lighting & Lighting Controls



**NEW**

**LED FLOODLIGHTS  
NIGHT FALCON™**

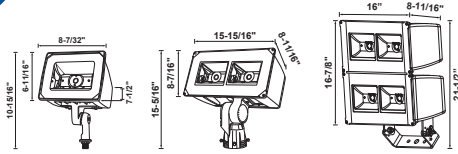

Night Falcon - Small  
Knuckle Mount

Night Falcon  
Slipfitter Mount

Night Falcon - Large  
Trunnion Mount

Whether the project is lighting a sign, building facade or parking lot, the Night Falcon™ LED floodlight series makes the choice easy. Combining value and performance in a robust design, the Night Falcon LED floodlight series offers two distributions that deliver superior uniformity and excellent illumination to the targeted application. With lumen packages ranging from 2,700 to 33,100 lumens, the Night Falcon LED floodlights are the ideal solution for replacing legacy metal halide solutions ranging from 70 to 1000 watts.

Vendor Code: **ETL**

Catalog Number	Mounting	Lumens	Color	Watts	Price Each
<b>NIGHT FALCON - SMALL</b>					
NFFLDSC15TUNV	Trunnion	5,900	4,000K	51	259.99
NFFLDSC15KNCUNV	Knuckle	5,900	4,000K	51	259.99
<b>NIGHT FALCON</b>					
NFFLDC25S	Slipfitter	10,530	4,000K	85	384.99
NFFLDC40S	Slipfitter	16,932	4,000K	128	467.99
NFFLDC25T	Trunnion	10,530	4,000K	85	369.99
NFFLDC40T	Trunnion	16,932	4,000K	128	454.99
<b>NIGHT FALCON - LARGE</b>					
NFFLDLC100S	Slipfitter	33,900	4,000K	252	966.99
NFFLDLC100T	Trunion	33,900	4,000K	252	939.99
<b>NIGHT FALCON - ACCESSORY</b>					
RABBZ	Right Angle Wall Mount Bracket for Slipfitter				99.97

**LED HIGH BAY LUMINAIRE**

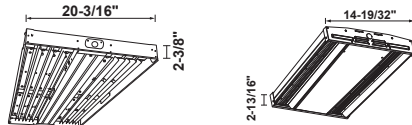

HBLED Series

VHBLED Series

Vendor Code: **ETL**

Catalog Number	Watts	Lumens	Color	LPW	Price Each
<b>HBLED SERIES</b>					
HBLEDLD512SEWUNV	75	11,456	5,000K	153	256.84
HBLEDLD524SEWUNV	149.5	22,339	5,000K	149	339.87
<b>VHBLED SERIES*</b>					
VHBLEDLD112WUNV	100	13,009	5,000K	130	152.31
VHBLEDLD118WUNV	160	19,263	5,000K	120	184.61
VHBLEDLD124WUNV	213	24,000	5,000K	112	229.23

\*Accessories Also Available Including an Installed 180° or 360° Motion Sensor and LumaWatt Wireless Sensor System. Ask Your Sales Representative for More Details.

**NEW**

**LED ROUND HIGH BAYS**

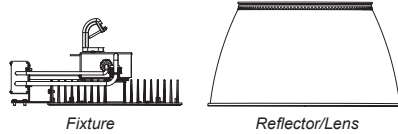

Fixture

Reflector/Lens

Vendor Code: **ETL**

Catalog Number	Watts	Voltage	Lumens	Price Each
<b>FIXTURES</b>				
RHB12UNVL850CDU	114	120-277	12,000	234.00
RHB18UNVL850CDU	154	120-278	18,000	267.00
RHB24UNVL850CDU	194	120-279	24,000	300.00

Vendor Code: **ETL**

Catalog Number	Description	Price Each
<b>REFLECTORS/LENS</b>		
RHBFR	16" Frosted Reflector	39.97
RHBCLR	16" Clear Reflector	39.97
RHBALR	16" Aluminum Reflector	39.97
RHBCGL	16" Clear Glass Shield	39.97

**INDUSTRIAL ACCESSORIES**

Vendor Code: **ETL**

Catalog Number	Description	Price Each
FH1	Fixture Hook (2-1/2")	6.97
SHK	Fixture Hook with Safety Screw (2-1/2")	10.79
FL1	Fixture Loop (2-1/2")	12.89

**LED WALL PACKS**

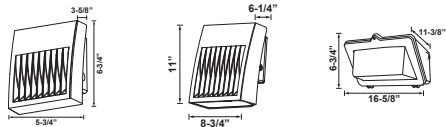

XTOR Crosstour™

XTOR Crosstour™ Maxx

Wal-Pak

Vendor Code: **ETL**

Catalog Number	Watts	Lumens	LPW	Price Each
<b>XTOR CROSSTOUR™ LED</b>				
XTOR1B	12	1,418	118	99.97
XTOR2B	18	2,135	119	120.48
XTOR3B	26	2,751	106	171.67
XTOR4B	38	4,269	112	199.97
<b>XTOR CROSSTOUR™ MAXX LED WITH REFRACTIVE LENS</b>				
XTOR6BRL	58	6,225	107	225.99
XTOR8BRL	81	8,635	107	303.99
<b>WAL-PAK WITH REFRACTIVE LENS</b>				
WPL3B	27	3,333	123	229.97
WPL4B	32	4,199	131	259.84
WPL6B	46	5,883	128	279.89





## LED Products (Outdoor Area Lighting · Security Flood Lighting)

### ALL-PRO™ LED AREA WALL LIGHT

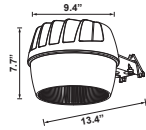

AL3050LPCGY

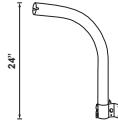

EA24

Vendor Code: **ETL**

Catalog Number	Watts	Lumens	Color	HID Equivalent	Price Each
<b>AL3050LPCGY*</b>	34	3,300	5,000K	175W	124.98
<b>EA24</b>	24" Mounting Arm for Pole Mount				18.24

\*Comes Standard with 12,000 Cycle Rated Integrated Photocontrol.  
\*Catalog Number Listed has a Gray (GY) Finish. For a Bronze Finish, Change the GY to **BR**.

### LED AREA LIGHT CARETAKER™

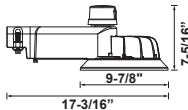

CTKRV1B

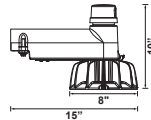

SRCARETAKER

Vendor Code: **ETL**

Catalog Number	Watts	Lumens	Color	HID Equivalent	Price Each
<b>CTKRV1B</b>	29	4,515	4,000K	100-150W	153.54
<b>SRCARETAKER</b>	Small Acrylic Refractor				32.32

CTKRV1A Comes Standard with NEMA 3-Pin Twistlock Photocontrol for Dusk-to-Dawn Operation.

### REVOLVE™ LED DUSK TO DAWN

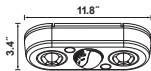

REV21835MW

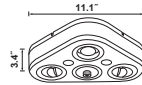

REV32735MW

The patents-pending Revolve™ LED outdoor security product line by All-Pro™ combines advanced LED technology and industry-leading optic design to bring you a low-profile fixture with uncompromising performance. An integral photo control provides nighttime ON, daytime OFF functionality. Refractive optics eliminate the need for bulky reflectors, while allowing you to easily aim the light precisely where you need it by simply rotating the optic. The end result is a sleek, aesthetically appealing LED fixture that remains virtually unnoticeable when not in use.

Vendor Code: **ETL**

Catalog Number	Watts	Lumens	Color	Price Each
<b>DOUBLE HEAD WITH 180° MOTION RANGE</b>				
<b>REV21850M</b>	27	2,150	5,000K	149.98
<b>TRIPLE HEAD WITH 270° MOTION RANGE</b>				
<b>REV32750M</b>	32	2,400	5,000K	162.48

White Finish

For a Bronze Finish, Remove the **W** from the End of the Catalog Number.

### HALO HOME SMART LED SECURITY FLOODS

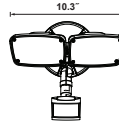

MST20C

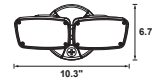

FTS20C

The HALO Home smart LED motion sensor flood incorporates Bluetooth® Mesh technology into a durable, twin head design for an advanced outdoor lighting solution built for high performance. The MST20C does not require a hub and can be wirelessly controlled directly from any compatible smart device utilizing the HALO Home app, or any HALO Home wireless switch or dimmer.

The HALO Home smart LED floodlight incorporates Bluetooth® Mesh technology into a durable, twin head design for an advanced outdoor lighting solution built for high performance. The FTS20C does not require a hub and can be wirelessly controlled directly from any compatible smart device utilizing the Halo Home app, or any Halo Home wireless switch or dimmer.

Vendor Code: **ETL**

Catalog Number	Finish	Lumens	Color	Price Each
<b>TWIN HEAD SQUARE FLOOD WITH 180° MOTION SENSOR</b>				
<b>MST20C18B</b>	Bronze	2,034	3,000K - 5,000K	150.39
<b>TWIN HEAD SQUARE FLOOD (NO SENSOR)</b>				
<b>FTS20CB</b>	Bronze	2,034	3,000K - 5,000K	120.05

For a White Finish, Replace the **B** with a **W** at the End of the Catalog Number.

### ALL-PRO™ LED SECURITY FLOODS

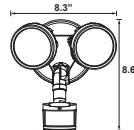

MST18R17L

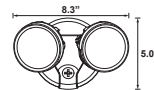

FTR1740L

The All-Pro™ LED Twin Head Round Motion Fixtures as well as the All-Pro™ LED Twin Head Round Flood Fixtures utilize the latest in LED technology for maximum light output in a low-profile, compact housing. This design is ideal as a direct replacement for traditional styles, producing the equivalent of a 150W incandescent fixture. Available in white or bronze, they can be wall or eave mounted for a wide range of applications.

Vendor Code: **ETL**

Catalog Number	Finish	Delivered Lumens	Color Temp.	Price Each
<b>TWIN HEAD ROUND FLOOD W/ 180° MOTION SENSOR</b>				
<b>MST18R17L</b>	Bronze	1,600	5,000K	105.97
<b>TWIN HEAD ROUND FLOOD (NO SENSOR)</b>				
<b>FTR1740L*</b>	Bronze	1,600	5,000K	99.62

For a White Finish, Add **W** to the End of the Catalog Number.

\*For Integrated Photocell, Add **PC** to the End of the Catalog Number. For Integrated Photocell and White Finish Add **PCW** to the End of Catalog Number.



Lighting & Lighting Controls

LED Products (Emergency Lighting · Bluetooth Shoplight · Undercabinet Lighting)

LED EMERGENCY LIGHTING

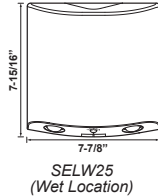
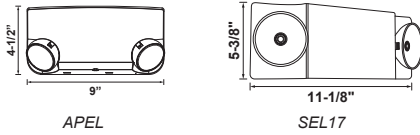

Vendor Code: ETL

Catalog Number	Description	Price Each
APEL	Two Long Life LED Emergency Heads	23.59
SEL17	LED Emergency Light with 17" Coverage	39.99
SELW25*	Sure-Lites Wet Location Emergency Light	98.73

120/277V

\*Catalog Number Listed Above is Silver in Color. Add Suffix BK for Black, BZ for Bronze, or WH for White.

LED EMERGENCY BATTERY PACKS

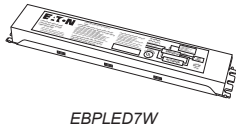

Vendor Code: ETL

Catalog Number	Description	Price Each
EBPLED14W	LED Emergency Battery Pack with 14W Output	248.18

LED EMERGENCY EXIT LIGHTS

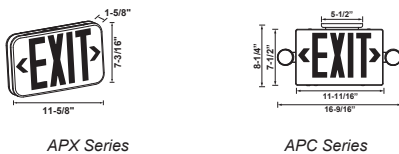

Vendor Code: ETL

Catalog Number	Description	Price Each
APX7R	Self-Powered LED, Red Letters, Universal Mounting, 120/277V	22.81
APC7R	Self-Powered Dual LED Heads, Red Letters, 120/277V	48.77

Add BK at the End of the Catalog Number for Black Housing. Change R to G for Green Lettering.

NEW

LED BLUETOOTH SHOPLIGHT

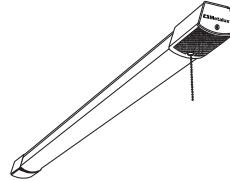

The SHP BTS is a fully integrated LED shoplight with Bluetooth wireless speakers. The SHP BTS speakers provide clear, balanced sound that can fill an entire workspace. Easily listen to your favorite music or podcast wirelessly in your home or workshop. This rugged, lightweight, portable and slim profile shoplight combines a polycarbonate housing body and lens with LEDs rated for 50,000 hours of life. Typical applications include workshops, garages, sheds and utility rooms.

Vendor Code: ETL

Catalog Number	Length	Lumens	Color	LPW	Price Each
4SHP3240BTS	4'	3,782	4,000K	122	93.74

Only Available in 4,000K

HU10 LED UNDERCABINET LIGHTS

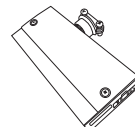
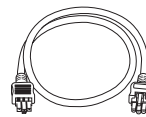
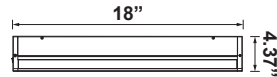

Ideal for task, accent, office, cove, utility, under and above cabinet lighting display, the Halo Undercabinet low-profile design delivers maximum energy savings and life with easy installation. The integrated driver allowing 120V direct to the fixture for easy installation. Fixtures are available in 9, 18, 24, 36, or 48 inch lengths, the Halo system can be configured to fit almost anywhere. Smooth dimming down to 5% using a standard dimmer. Connector cables in a variety of different lengths make it easy to link one unit to another. Each unit has an integrated on-off switch.

Vendor Code: ETL

Catalog Number	Description	Price Each
<b>HALO INTEGRATED DRIVER UNDERCABINET</b>		
HU1018D930P*	18" Dimmable Fixture, 90 CRI, 3,000K, White Finish	70.85
HU1024D930P*	24" Dimmable Fixture, 90 CRI, 3,000K, White Finish	72.24
HU1036D930P*	36" Dimmable Fixture, 90 CRI, 3,000K, White Finish	115.58
<b>CONNECTORS</b>		
HU103P*	24" Daisy Chain Connector, White Finish	24.19
HU109P*	Splice Box, White Finish	30.79

Replace P with MB for Matte Black.



C

Lighting & Lighting Controls





## Fluorescent Products (Lay-In Lensed Troffers · Strip Lights · Undercabinet Lighting)

### ALL PRO FLUORESCENT LENSED TROFFERS

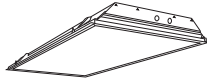

Vendor Code: **ETL**

Catalog Number	Number of Lamps	Lamp Type	Length	Price Each
<b>APT2U6T8</b>	2	F32T8U	2' x 4'	63.17
<b>APT332L735</b>	3	F32T841K*	2' x 4'	82.16
<b>APT432L741</b>	4	F32T841K*	2' x 4'	84.28
<b>REPLACEMENT LENS</b>				
<b>A12100242GU</b>	-	-	-	14.29

120/277V

\*Lamps Included.

### ALL PRO FLUORESCENT STRIP LIGHTS



Vendor Code: **ETL**

Catalog Number	Number of Lamps	Lamp Type	Length	Price Each
<b>STANDARD BODY 120-277V</b>				
<b>SSF232UNVEB81U</b>	2	F32T8	4'	44.28
<b>APS8WS232</b>	4	F32T8	8'	54.59
<b>HIGH OUTPUT 120V</b>				
<b>SSF296H0120VEB21**</b>	2	F96T12H0	8'	123.18
<b>WIRE GUARD</b>				
<b>WGS5SF4FTB</b>	-	-	4'	16.24

\*120V Only.

\*\* Low Power Factor Ballast

### ALL PRO FLUORESCENT WRAP AROUND FIXTURES



Vendor Code: **ETL**

Catalog Number	Number of Lamps	Lamp Type	Length	Price Each
<b>APWGPW232</b>	2	F32T8	4'	35.58
<b>APWGPW432</b>	4	F32T8	4'	53.68

120/277V



### FLUORESCENT INDUSTRIAL VAPORTIGHT

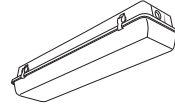

The VT3 Series is a contemporary looking energy efficient industrial Vaportite fixture that features rugged and durable construction. The VT3 incorporates a full metal gear tray inside a reinforced fiberglass housing with a high impact diffuser. This Vaportite series is suitable for interior and exterior applications and can be surface or chain mounted. The VT3 Series has been designed for maximum operation in commercial institutional and industrial environments where weathering, high temperature, humidity and dust or corrosive fumes are present.

Vendor Code: **ETL**

Catalog Number	Number of Lamps	Lamp Type	Length	Price Each
<b>VT3232DRUNVEB81W</b>	2	F32T8	4'	118.23

120/277V



### FLUORESCENT HIGH BAY (F-BAYS)



APHL series is ideal for industrial or retail applications. Optical designs provide ideal performance from either T5 or T8 lamps. Uplight component produces excellent ceiling uniformity. APHL's high lumen package allows the benefits of fluorescent to be applied at high mounting heights that were traditionally exclusive to H.I.D. Benefits include exceptional color rendering, high system efficacy, long lamp life, instant on/instant re-strike, and uniform APHL applications include retail, shopping malls, light industrial and recreational environments.

Vendor Code: **ETL**

Catalog Number	Description	Price Each
<b>APHL654SNUPLL850</b>	2' x 4', 6-54W T5H0 with 5,000K Lamps	189.97

Popular Fixtures Indicated in Bold.

120/208/240/277V

### FLUORESCENT UNDERCABINET LIGHTS

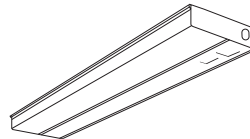

Vendor Code: **ETL**

Catalog Number	Length	Number of Lamps	Lamp Type	Price Each
<b>UC12T518LP41</b>	12"	1	T5	26.71
<b>UC18T8115LP41</b>	18"	1	T8	39.37
<b>UC24T8117LP41</b>	24"	1	T8	34.36
<b>UC36T8125LP41</b>	36"	1	T8	42.95

Lighting & Lighting Controls



LED Products (Lay-Ins · Flat Panels · Strip Lights · Wrap Arounds)

LED LAY-INS  
BLT SERIES

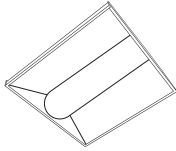

The BLT Series offers a clean design, shallow fixture-depth for easy installation, plug-n-play or wireless control options. An extensive selection of configurations and options make the BLT the perfect choice for many lighting applications including schools, offices and other commercial spaces, retail, hospitals and healthcare facilities. The low profile BLT design (2-3/8") also makes it an excellent choice for renovation projects.

GTL SERIES

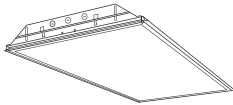

The GTL Series LED recessed troffer's economical, solid-state lighting is ideal for new construction, renovation and retrofit opportunities. It is ideal for the broad range of applications where general-purpose fluorescent lighting currently prevails including offices, schools and commercial general-ambient applications.

Vendor Code: LIT

Catalog Number	Size	Watts	Lumens	LPW	Kelvin	Price Each
<b>BLT SERIES</b>						
2BLT233LADPLP840*	2' x 2'	30	3,313	111	4,000K	119.99
2BLT446LADPLP840*	2' x 4'	38	4,620	120	4,000K	159.99
<b>GTL SERIES</b>						
2GTL2120LP840	2' x 2'	18	2,223	124	4,000K	89.99
2GTL4120LP840	2' x 4'	29	3,980	137	4,000K	94.99

\*BLT Series Catalog Numbers Listed Above are 4,000K (40). Replace 40 with 30 for 3,000K, 35 for 3,500K, and 50 for 5,000K.



LED FLAT PANELS



The EPANL is a visually stunning, low profile, easy to install luminaire. The fully luminous lens provides a glare free solution creating a very comfortable environment. With a depth of only two inches, restricted plenum space is no longer a concern. The EPANL is available in two lumen packages and three sizes with multiple configurations for a versatile solution that is DLC qualified (Standard and Premium) and eligible for utility rebates.

Vendor Code: LIT

Catalog Number	Size	Watts	Lumens	LPW	Kelvin	Price Each
EPANL2440L40K	2' x 4'	39	4,351	112	4,000K	110.99
EPANL2234L40K	2' x 2'	31	3,479	112	4,000K	89.99



LED STRIP LIGHTS  
MNSL SERIES

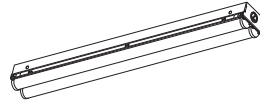

The basic, non-dimming, damp location MNSL strip lights mount individually or in continuous rows to the ceiling or wall, both horizontally or vertically.

- Diffuse acrylic lens providing a single smooth line of light shaped to resemble a fluorescent tube
- Quick and simple to install with the snap-lock tool-less channel cover
- Ideal choice for commercial task lighting, restrooms, under/over cabinet, storage closets and displays

Vendor Code: LIT

Catalog Number	Size	Watts	Lumens	LPW	Kelvin	Price Each
MNSLL482LLMV0LT4	4'	50	4,500	90	4,000K	56.99
MNSLL962LLMV0LT4	8'	90	8,200	91	4,000K	112.99

LED WRAP AROUNDS

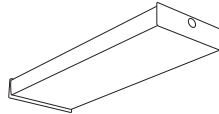

SBL Series

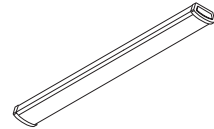

FMLWL Series

The SBL LED wrap around provides a digital lighting platform to deliver general ambient lighting for surface-mount applications. The LED system delivers long life and excellent color to ensure a quality, low-maintenance lighting installation. Ideal for closets, storage rooms, hallways, and offices.

The FMLWL Series LED Linear Flush Mount provides up to 50,000 hours of energy-saving LED lighting. Low-profile, linear fixture with decorative plastic end caps and white, acrylic diffuser for wide spread, uniform illumination.

Vendor Code: LIT

Catalog Number	Size	Watts	Lumens	LPW	Kelvin	Price Each
<b>SBL SERIES</b>						
SBL2LP840	2'	17	1,967	116	4,000K	105.99
SBL4LP840	4'	32	3,994	125	4,000K	109.99
<b>FMLWL SERIES</b>						
FMLWL24840**	2'	20	1,200	60	4,000K	57.66
FMLWL48840**	4'	40	2,380	60	4,000K	62.47

\*\*Available in 3,000K and 4,000K

\*\*Available in 2,700K, 3,000K, 3,500K, 4,000K



An Acuity Brands Company





## LED Products (Wet Location Lighting · Shoplights · High Bays)

### LED WET LOCATION VAPOR TIGHT XVML



These fully-gasketed, wet-location, and code-compliant vapor-tights are DLC® listed and IP65 and IP66 rated. They can be surface mounted on the ceiling or wall and are designed for continuous row mounting. The XVML vapor-tights are ideal for outdoor venues, canopies and locker rooms.

- The fully gasketed, polycarbonate housing with ten polycarbonate captive latches provides a water-tight seal and stands up to dust and dirt with its IP65 and IP66 ratings
- Provides the performance you need with the UV-stabilized, high-impact, frosted polycarbonate lens for uniform light output and high impact-resistance
- Quick and simple to install with the snap-lock tool-less access

Vendor Code: **LIT**

Catalog Number	Size	Watts	Lumens	Color	Price Each
<a href="#">XVMLL483500LMMV</a>	4'	33	3,558	4,000K	116.41
<a href="#">XVMLL485000LMMVO</a>	4'	49	5,000	4,000K	168.00

Also Available in 5,000K

### LED SHOPLIGHT

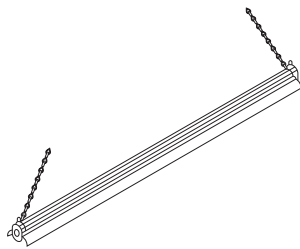

The stylish LED Shoplight provides general illumination and is constructed of a metal housing with decorative end caps and a rocker switch for easy on/off operation. It is ideal for workshops, game rooms, utility rooms and garages.

- The white polycarbonate lens provides even illumination on surfaces where tasks are performed
- LEDs have a 35,000 hour L70 rated life
- Provides a cool color temperature of 4,000K with a CRI of 80
- Switch is located on the end

Vendor Code: **LIT**

Catalog Number	Size	Watts	Lumens	Color	Price Each
<a href="#">SHLP48IN40K80CRI</a>	4'	36	3,200	4,000K	27.38



An **Acuity** Brands Company

### LED HIGH BAYS I-BEAM IBE SERIES

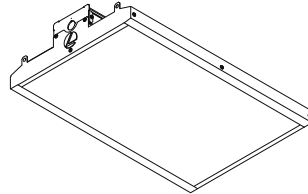

The right selection for your basic, affordable warehouse lighting - the I-BEAM® IBE LED luminaire gives budget-conscious customers a reliable LED solution featuring 6kV surge protection standard. The I-BEAM® IBE LED is designed to meet the challenges of warehouse and light industrial applications.

- Robust 6kV surge protection standard, meeting the ANSI standard for Industrial Environments
- UL listed to 45°C ambient with a thermal management system allowing for safe operation during times when temperatures rise up to 55°C\*
- Save up to 60% in energy and maintenance costs over traditional sources
- Compact 2' housing

Vendor Code: **LIT**

Catalog Number	Watts	Lumens	Color	Price Each
<a href="#">IBEL12LMMVOLT40K</a>	83	12,000	4,000K	127.64
<a href="#">IBEL18LMMVOLT40K</a>	136	18,000	4,000K	172.61
<a href="#">IBEL22LMMVOLT40K</a>	165	22,000	4,000K	192.50

Catalog Numbers Listed are 4,000K (40). Replace 40 with 50 for 5,000K.

### LED ROUND HIGH BAYS JEBL SERIES

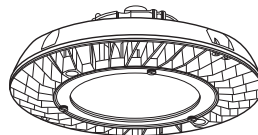

The JEBL is built to last with 6kV surge protection standard, 55°C ambient temperature rating, and IP65 rated for elimination of dust, moisture and airborne contaminants. The unique, quick-connect driver-to-optical assembly interface allows for quick and easy maintenance for applications including warehousing, gymnasiums, manufacturing and outdoor canopies.

- Robust 6kV surge protection standard, meeting the ANSI standard for Industrial environments
- Mounting heights up to 30 feet. It is listed for wet locations and IP65 rated to help protect against dust, and airborne contaminants from indoor and outdoor environments
- The removable quick-disconnect driver housing that allows for easy field replacement of the LED driver, eliminating the need to replace the entire fixture

Vendor Code: **LIT**

Catalog Number	Watts	Lumens	Color	Price Each
<a href="#">JEBL12L50K80CRIW</a>	92	13,190	5,000K	214.74
<a href="#">JEBL18L50K80CRIW</a>	136	19,770	5,000K	269.83
<a href="#">JEBL24L50K80CRIW</a>	191	26,189	5,000K	315.45

Catalog Numbers Listed are 5,000K (50). Replace 50 with 40 for 4,000K.

LED Products (Downlights · Undercabinet Lighting · Emergency Lighting · Exit Lights)

LED DOWNLIGHTS

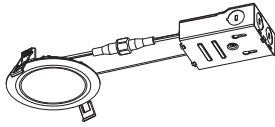

Wafer LED

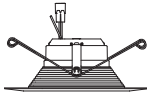

E Series

The 4" and 6" Wafer™ LED Downlight with Switchable White provides high-quality light output and efficiency featuring a switch for easy color temperature adjustment - while eliminating the need for recessed housings. The innovative, slim design allows for easy retrofit, remodel or new construction installation from below the ceiling. The Wafer LED downlight is wet location listed - making it ideal for use in a breadth of outdoor residential, hospitality, commercial and multifamily applications.

Combining dependable performance, low cost and the energy-saving benefits of as much as 35,000 hour-life LED, E Series LED recessed modules offer an optimal value for a variety of residential and light commercial applications. With 4" to 6" coverage available in multiple color temperatures, the cost and flexibility of E Series makes it the perfect LED option for high-volume projects and everyday stock business.

Vendor Code: LIT

Catalog Number	Size	Watts	Lumens	Kelvin	Price Each
<b>WAFER LED</b>					
WF4LED30K40K50K9*	4"	10	810	3,000K-5,000K	25.05
WF6LED30K40K50K9*	6"	13	1,190	3,000K-5,000K	30.06
<b>E SERIES LED RECESSED MODULES</b>					
4BEMWLED40K90CRI**	4"	10	720	4,000K	15.20
65BEMWLED40K90CRI**	6"	12	845	4,000K	15.20

\*Lumen Output Based on 4,000K Selection.  
 \*\*Catalog Numbers Listed are 4,000K (40). Replace 40 with 27 for 2,700K, 30 for 3,000K, and 50 for 5,000K.

LED UNDERCABINET LIGHTS

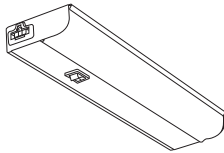

LED undercabinet lighting can be used as a source of task or accent lighting in new construction and retrofit applications. Smooth illumination lenses make the UCEL ideal for use under and over cabinets, display cases, task lighting, office lighting, cover and utility/ work areas in commercial, retail, hospitality and residential applications.

- Available in 12", 24" and 36" lengths.
- Produces 388 - 1,162 lumens.
- Features an on/off rocker switch

Vendor Code: LIT

Catalog Number	Size	Watts	Lumens	Kelvin	Price Each
UCEL12IN30K90	12"	6	385	3,000K	44.99
UCEL24IN30K90	24"	10	740	3,000K	67.99
UCEL36IN30K90	36"	15	1,160	3,000K	90.99
UCEL48IN30K90	48"	20	1,600	3,000K	101.99

Catalog Numbers Listed are 3,000K (30). Replace 30 with 35 for 3,500K, and 40 for 4,000K.

LED EMERGENCY LIGHTING

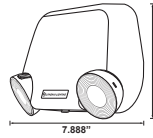

EU2LM12

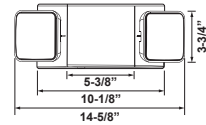

EU2CM6

Vendor Code: LIT

Catalog Number	Description	Price Each
EU2LM12	Two .75W LED Heads	29.64
EU2CM6	Two 1W LED Heads, CA Certified	33.48

120/277V

LED EXIT LIGHTS

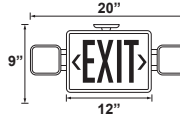

ECRLEDM6

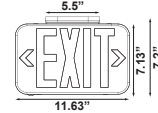

EXRLEDLM6

Vendor Code: LIT

Catalog Number	Description	Price Each
ECRLEDM6	Dual Heads, Red Letters	62.99
EXRLEDLM6	Red Letters w/ Battery Backup	79.99

120/277V

LED VAPORPROOF FIXTURES



OLVTCMM6



OLVTWMM6

Vendor Code: LIT

Catalog Number	Watts	Lumens	Kelvin	Price Each
OLVTCMM6	15	600	4,000K	166.58
OLVTWMM6	15	600	4,000K	169.99

120/277V

50,000 Hours



Lighting & Lighting Controls



## LED Products (Wall Packs · Tall Packs · Flood Lights · Canopy Lights · Area Lights)

### LED TRADITIONAL WALL PACKS

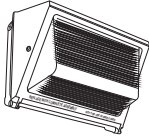

TWR1LEDAL050KMV

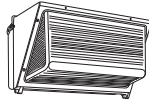

TWR2LEDAL050KMV0

Vendor Code: LIT

Catalog Number	Watts	Lumens	Color	HID Equivalent	Price Each
TWR1LEDAL050KMV	9-51	1,100-6,200	5,000K	70w-250w	157.99
TWR2LEDAL050KMV0	21-87	3,050-11,800	5,000K	150w-400w	236.43

Catalog Number Listed is 5,000K (50). Replace 50 with 40 for 4,000K.

### LED TALL PACKS

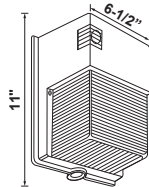

TWSLEDP150KMV0LT

Vendor Code: LIT

Catalog Number	Watts	Lumens	Color	HID Equivalent	Price Each
TWSLEDP150KMV0LT	28	2,100	5,000K	100w	111.90

### LED FLOOD LIGHTS



Knuckle Mounting



Slipfitter Mounting

Vendor Code: LIT

Catalog Number	Watts	Lumens	Color	Mounting	Price Each
0FL1LEDP150KMV	21	2,333	5,000K	Knuckle	179.99
0FL1LEDP250KMV0L	45	4,466	5,000K	Knuckle	229.99
0FL2LEDP250KMV0L	114	12,154	5,000K	Slipfitter	379.99
0FL2LEDP350KMV0L	151	16,261	5,000K	Slipfitter	399.99

Catalog Number Listed is 5,000K (50). Replace 50 with 40 for 4,000K

### LED SECURITY FLOOD LIGHTS

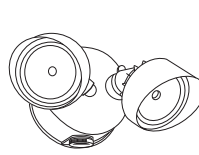

OLF2RH40K120BZ

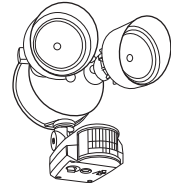

OLF2RH40K120M0BZ

Vendor Code: LIT

Catalog Number	Watts	Lumens	Color	Finish	Price Each
OLF2RH40K120BZ	25	2,160	4,000K	Bronze	99.99
OLF2RH40K120M0BZ	25	2,160	4,000K	Bronze	139.99

Replace BZ with WH for White Finish.

\*Includes Motion Sensor

### LED CANOPY

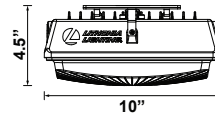

Vendor Code: LIT

Catalog Number	Watts	Lumens	Color	HID Equivalent	Price Each
CNYLEDP150KMV0LT	35	4,500	5,000K	150w	130.99

Catalog Number Listed is 5,000K (50). Replace 50 with 40 for 4,000K

Also Available with White Finish.

### LED AREA LIGHT

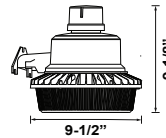

TDD2LEDP150K120

Vendor Code: LIT

Catalog Number	Watts	Lumens	Color	HID Equivalent	Price Each
TDD2LEDP150K120	41	4,700	5,000k	175w	164.44

Catalog Number Listed is 5,000K (50). Replace 50 with 40 for 4,000K

Also Available with White Finish



Lighting & Lighting Controls

Fluorescent Products (Wrap Around Fixtures · Lensed Troffers · High Bays)

C

Lighting & Lighting Controls

FLUORESCENT GENERAL-PURPOSE STRIP LIGHTS

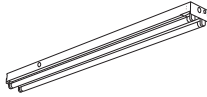

TC232MV

Vendor Code: LIT

Catalog Number	Number of Lamps and Type	Length	Price Each
<b>C232MV</b>	2: F32T8	4'	53.99
<b>C296T8MV</b>	2: F96T8	8'	58.99
<b>TC232MV</b>	4: F32T8	8'	55.99

WIREGUARD

<b>WGCUNNST</b>	C & UN Series	4'	17.99
-----------------	---------------	----	-------

Lamps Not Included  
Electronic, Instant Start Ballasts  
Popular Fixtures Indicated In Bold.

FLUORESCENT SQUARE-BASKET WRAP AROUND FIXTURES

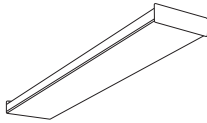

Vendor Code: LIT

Catalog Number	Number of Lamps and Type	Length	Price Each
<b>SB232MV</b>	2: F32T8	4'	48.99
<b>SB432MV</b>	4: F32T8	4'	59.99

Lamps Not Included  
Electronic, Instant Start Ballasts  
Popular Fixtures Indicated In Bold.

FLUORESCENT LENSED TROFFERS

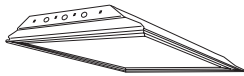

GT2UMV

Vendor Code: LIT

Catalog Number	Number of Lamps and Type	Price Each
<b>GT2UMV</b>	2: F32T8	67.99
<b>GT3MV</b>	3: F32T8	57.99
<b>GT4MV</b>	4: F32T8	59.99

Lamps Not Included  
Electronic, Instant Start Ballasts

FLUORESCENT EMERGENCY BATTERY PACK



PSQ500QD

Factory - or field-installed inside or outside (field only) a fluorescent fixture to operate lamp(s) at an initial output of 10% to 95% of rated lamp lumens, providing optimum glare-free illumination for a minimum of 90 minutes upon interruption of normal power.

Vendor Code: LIT

Catalog Number	Description	Price Each
<b>QUICK MOUNT BATTERY PACK</b>		
<b>PSQ500QDMVOLT</b>	500 Lumen Output	99.99
<b>PS1400QDM8</b>	1,400 Lumen Output	196.99

FLUORESCENT HIGH BAYS

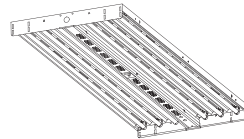

The IBZ fluorescent high bay is ideal for new construction and renovation projects. It is a one-for-one replacement of common metal halide high bay systems. The unique Cool Running Plus™ technology provides industry-leading, trouble-free operation in ambient temperatures up to 155°F (68°C). Applications include manufacturing, warehousing, commercial and industrial facilities. The IBZ fixture performs well at mounting heights from 15'-40'.

Vendor Code: LIT

Catalog Number	Description	Price Each
<b>IBZ654L</b>	2' x 4', 6-54W T5 Univ. with 4,100K Lamps	187.99

Electronic, Programmable Rapid Start Ballasts  
Popular Fixtures Indicated in Bold.





## LED Products (Floodlights · Area Lights · Poles · Pole Accessories)

### LED FLOODLIGHTS FFLED™

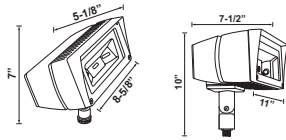

FFLED18

FFLED39

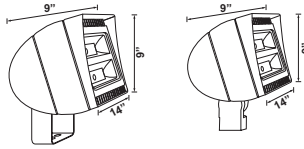

FXLED78/FXLED150  
Trunnion Mount

FXLED78/FXLED150  
Slipfitter Mount

Vendor Code: **RAB**

Catalog Number	Watts	Lumens	Mount	Price Each
FFLED18	18	2,310	Swivel Arm	219.99
FFLED39	39	5,666	Swivel Arm	299.99
FXLED150SF	150	20,868	Slip Fitter	667.08
FXLED150T	150	20,868	Trunnion	655.57
FXLED300SF	300	45,171	Slip Fitter	1429.99
FXLED300T	300	45,171	Trunnion	1159.99

The Catalog Numbers Listed Above are 5,000K. Also Available in 3,000K and 4,000K.

### NEW LED SLIM FLOODLIGHTS X34

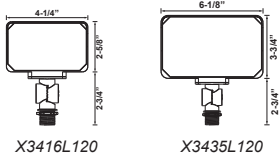

X3416L120

X3435L120

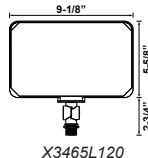

X3465L120

Vendor Code: **RAB**

Catalog Number	Watts	Lumens	Mount	Price Each
X3416L120	15	1,600	Knuckle	32.89
X3435L120	35	3,500	Knuckle	58.09
X3465L120	64	6,500	Knuckle	90.99

The Catalog Numbers Listed Above are 5,000K. Also Available in 3,000K.

### LED ECONOMY FLOODLIGHTS PIP™

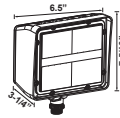

Vendor Code: **RAB**

Catalog Number	Watts	Lumens	Mount	Price Each
PIP15D10	15	2,091	Knuckle	98.99
PIP30D10	30	4,162	Knuckle	139.99
PIPL70SFD10	70	10,601	Slip Fitter	269.99
PIPL100SFD10	100	15,839	Slip Fitter	329.99

Bronze Finish  
The Catalog Numbers Listed Above are 5,000K. Also Available in 3,000K and 4,000K. 70w and 100w Also Available with Trunnion Mount.

### NEW LED AREA LIGHTS ALED™

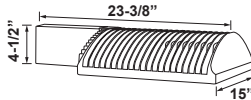

- Replaces up to 400W MH
- For use in parking lots, roadways, pathways and general area lighting.
- Mounts to 4" square steel poles at 15-25'.

Vendor Code: **RAB**

Catalog Number	Watts	Lumens	Distribution	Price Each
ALED2T105	105	13,213	Type II	849.99
ALED3T150	150	16,839	Type III	869.99
ALED4T150	150	18,464	Type IV	889.99

The Catalog Numbers Listed Above are 5,000K. Also Available in 3,000K and 4,000K.

### LED AREA LIGHTS YARDBLASTER

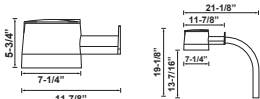

YBLED26

YBLED26ARM

Vendor Code: **RAB**

Catalog Number	Watts	Lumens	Price Each
YBLED26	26	3,685	159.99
YBLED26ARM*	26	3,685	189.99

\*Includes Arm Mount

### POLE ACCESSORIES

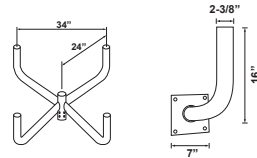

Bull4

MCB

Vendor Code: **RAB**

Catalog Number	Description	Price Each
BULL2	Two Light Bullhorn, Bronze	179.99
BULL2W	Two Light Bullhorn, Galvanized Steel	199.99
BULL3	Three Light Bullhorn, Bronze	269.99
BULL4	Four Light Bullhorn, Bronze	749.99
BWC12	Curved Wall Mount Bracket, Galvanized Steel	139.99
MCB	Angle Bracket for Wood, Bronze	99.99
MAB	Right Angle Wall Mount Bracket, Bronze	89.99

### POLES

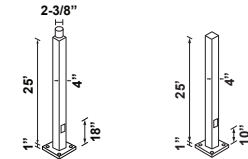

PS41125WT

PS41125D2

Vendor Code: **RAB**

Catalog Number	Shaft	Gauge	Height	Price Each
<b>TENON TOP POLES</b>				
PS41115WT	4"	11	15'	699.99
PS41120WT	4"	11	20'	799.99
PS41125WT	4"	11	25'	999.99
PS40725WT	4"	7	25'	988.00
PS50725WT	5"	7	25'	1499.99
PS50730WT	5"	7	30'	1799.99
<b>DRILLED POLES</b>				
PS41115D2	4"	11	15'	699.99
PS41120D2	4"	11	20'	799.99
PS41125D2	4"	11	25'	999.99
PS40725D2	4"	7	25'	1199.99
PS50725D2	5"	7	25'	1499.99
PS50730D2	5"	7	30'	1799.99



Lighting & Lighting Controls

**NEW**

**LED HIGH BAYS  
AEROBAY™**

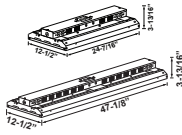

Vendor Code: **RAB**

Catalog Number	Watts	Lumens	LPW	Price Each
<b>ARBAY290</b>	90	11,812	134	169.99
<b>ARBAY2125</b>	125	17,462	136	199.99
<b>ARBAY4175</b>	175	23,960	136	249.99
<b>ARBAY4260</b>	260	36,224	137	339.99

White Finish

The Catalog Numbers Listed Above are 5,000K. Add **N** to End of Catalog Number for 4,000K.

**LED HIGH BAYS  
HAYBAY™**

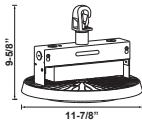

Vendor Code: **RAB**

Catalog Number	Watts	Lumens	LPW	Price Each
<b>HAYBAY150ND10</b>	150	18,816	125	299.99
<b>HAYBAY180ND10</b>	180	21,242	118	329.99

White Finish

The Catalog Numbers Listed Above are 5,000K. Also Available in 4,000K.

**LED GARAGE LIGHTS**

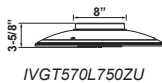
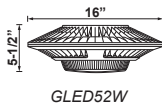

Vendor Code: **RAB**

Catalog Number	Watts	Lumens	Color Temp.	Price Each
<b>GLED52W*</b>	52	4,975	5,100K	499.99
<b>IVGT570L750ZU</b>	69	7,000	5,000K	529.99

\*White Color

Add **Y** to end of Catalog Number for 3,000K or **N** to End of Catalog Number for 4,000K. For Catalog Number GLED52W, the Color Change Options are added before the letter

**LED WALL PACKS  
LPACK®**

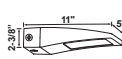

WPLED10

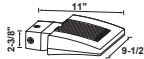

WPLED18

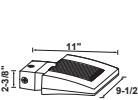

WPLED26

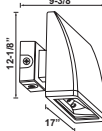

WPLED104

Vendor Code: **RAB**

Catalog Number	Watts	Lumens	Color Temp.	Price Each
<b>WPLED10</b>	10	1,208	5,000K	192.99
<b>WPLED18*</b>	18	2,508	5,000K	284.99
<b>WPLED26*</b>	26	3,475	5,000K	339.99
<b>WPLED104</b>	104	13,129	5,000K	559.99

\*WPLED Models 13, 18, and 26 Include Two Mounting Options: Surface Plate and Junction Box. The Catalog Numbers Listed Above are 5,000K. Add **Y** to end of Catalog Number for 3,000K or **N** to End of Catalog Number for 4,000K.

Wattages	Can be Used as a Substitute for
<b>18W</b>	100-175W Metal Halide Wallpacks
<b>26W</b>	150 - 200W Metal Halide Wallpacks
<b>52W</b>	250W HID Wallpacks
<b>104W</b>	400W Metal Halide Wallpacks

**NEW LED WASHDOWNS  
SHARK™**

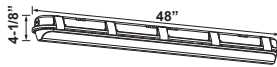

- SHARK™ is ideal for car washes, tunnels, stairwells and other hard-to-reach areas where relamping is difficult and costly.
- Two sizes and four power packages available: 50W (4 ft), 36W (4 ft), 25W (2 ft), 18W (2 ft)
- At up to 100 lm/W, SHARK provides an energy efficient replacement for fluorescent tubes, reducing energy consumption by over 40%.

Vendor Code: **RAB**

Catalog Number	Watts	Lumens	Price Each
<b>4' LENGTH</b>			
<b>SHARK450WD10</b>	50	5,161	229.99
<b>8' LENGTH</b>			
<b>SHARK8100WD10</b>	100	13,429	399.99

Catalog Numbers Listed are 5,000K. Also Available in 3,000K, 3,500 or 4,000K.

**WALL PACKS  
TRADITIONAL**



WP1LED30

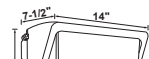

WP2LED37

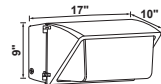

WP3LED55

Vendor Code: **RAB**

Catalog Number	Watts	Lumens	Color Temp.	Price Each
<b>WP1LED30</b>	30	3,060	5,000K	189.99
<b>WP2LED37</b>	37	4,329	5,000K	209.99
<b>WP3LED55</b>	55	6,645	5,000K	319.99
<b>WP3LED65</b>	65	7,559	5,000K	379.99
<b>WP3LED82</b>	82	9,280	5,000K	449.99
<b>WP3LED110</b>	110	15,113	5,000K	499.99

Bronze Color

The Catalog Numbers Listed Above are 5,000K. Add **Y** to End of Catalog Number for 3,000K or **N** to End of Catalog Number for 4,000K.

**NEW WALL PACKS  
W34**

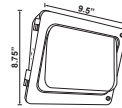

W3430L

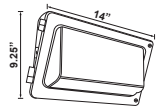

W3455L

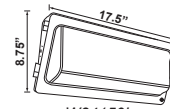

W34150L

Vendor Code: **RAB**

Catalog Number	Watts	Lumens	Color Temp.	Price Each
<b>W3430L</b>	30	3,105	5,000K	133.99
<b>W3455L</b>	51	5,375	5,000K	103.99
<b>W34150L</b>	136	14,845	5,000K	224.20

The Catalog Numbers Listed Above are 5,000K. Add **830** to End of Catalog Number for 3,000K.







## LED Products (Compact Floodlighting · Wrap Arounds)

**NEW**

### LED ECONOMY COMPACT FLOODS LESLIE

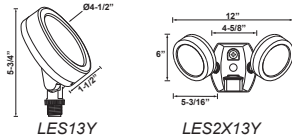

#### LES13Y

- Equivalent to 75W halogen BR30 wide flood
- Wide 6H x 6V distribution

#### LES2X13Y

- Equivalent to two 75W halogen BR30 wide floods
- Wide 6H x 6V distribution

Vendor Code: **RAB**

Catalog Number	Watts	Lumens	Finish	Price Each
<b>SINGLE HEAD</b>				
<b>LES13Y</b>	13	1,169	Bronze*	55.99
<b>DUAL HEADS</b>				
<b>LES2X13Y</b>	26	2,090	Bronze*	129.99

Catalog Numbers Listed Above are 3,000K. Change **Y** to **N** for 4,000K, Remove **Y** for 5,000K. \*For Black Finish Add **B** at End, for Verde Green Add **VG**, for White Add **W**.

### LED COMPACT FLOODS LFLED

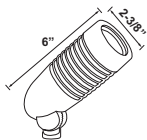

LFLED5A/LFLED8YA

Vendor Code: **RAB**

Catalog Number	Watts	Lumens	Color Temp.	Price Each
<b>LFLED5A</b>	5	299	5,000K	89.99
<b>LFLED8YA</b>	8	511	3,000K	89.99

Bronze Finish

### LED SPOTLIGHT

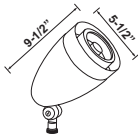

Vendor Code: **RAB**

Catalog Number	Watts	Lumens	Price Each
<b>HSLED13A</b>	13	1,502	279.99

### LED BULLET™ FLOODS

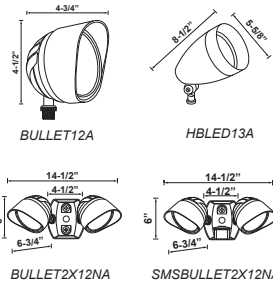

#### BULLET12A

- 12W LED equivalent to 75W BR30/halogen/wide flood
- Mount as an uplight or downlight on a RAB Mighty Post or junction box

#### HBLED13A

- 80% energy savings vs. PAR floods
- Mount on junction box or on RAB Mighty Post

#### BULLET2X12NA

- Two adjustable 12W LED floodlights
- Equivalent to 2x75W BR30/halogen/wide floods

#### SMSBULLET2X12NA

- Two adjustable 12W LED floodlights
- Sensor with 180° detection pattern at up to 30 ft.

Vendor Code: **RAB**

Catalog Number	Watts	Lumens	Price Each
<b>SINGLE HEAD</b>			
<b>BULLET12A</b>	12	1,240	89.99
<b>HBLED13A</b>	13	1,799	259.99
<b>DUAL HEADS (2 X 12W)</b>			
<b>BULLET2X12A</b>	24	2,528	199.99
<b>DUAL HEADS (2 X 12W) W/MOTION SENSOR</b>			
<b>SMSBULLET2X12NA</b>	24	2,528	259.99

Bronze Finish

### FLOODLIGHT KITS AND SENSORS

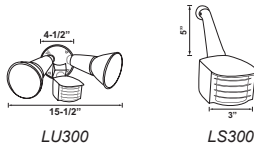

LU300

LS300

Vendor Code: **RAB**

Catalog Number	Description	Price Each
<b>FLOODLIGHT KITS W/OCCUPANCY SENSOR</b>		
<b>LU300</b>	300W, 120V, Bronze	37.99
<b>LU300W</b>	300W, 120V, White	37.99
<b>SENSORS ONLY</b>		
<b>LS300</b>	Sensor for LU300	33.99
<b>LS300W</b>	Sensor for LU300W	33.99

**NEW**

### LED WRAP AROUNDS GUS

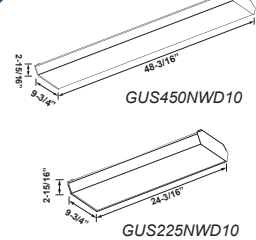

GUS450NWD10

GUS225NWD10

Vendor Code: **RAB**

Catalog Number	Watts	Lumens	Color Temp.	Price Each
<b>2' LENGTH</b>				
<b>GUS225NWD10</b>	25	2,757	4,000K	99.99
<b>4' LENGTH</b>				
<b>GUS450NWD10</b>	45	5,456	4,000K	133.99

The Catalog Numbers Listed Above are 4,000K, 3,000K, and 3,500K are Also Available.

### LED VAPORPROOF FIXTURES

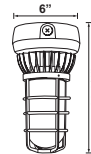

Vendor Code: **RAB**

Catalog Number	Watts	Lumens	Price Each
<b>VXLED13DG</b>	13	729	189.99
<b>VXLED26DG</b>	26	2,004	259.99

### MIGHTY POSTS

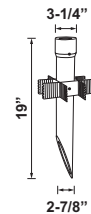

Vendor Code: **RAB**

Catalog Number	Description	Price Each
<b>MP19B</b>	19" Black Mounting Post	36.99



Lighting & Lighting Controls

LED Lamps (A-Line · Reflector · PAR · MR16 · Decorative)

LED A-LINE LAMPS



Vendor Code: **RAB**

Catalog Number	Watts	Color	Lumens	CRI	Price Each
<b>DIMMABLE</b>					
<b>A196E26930DIM</b>	6	3,000k	450	90	2.99
<b>A199E26930DIM</b>	9	3,000k	800	90	3.69
<b>A1913E26830DIM</b>	13	3,000k	1,100	80	4.29
<b>NON-DIMMABLE</b>					
<b>A196E26830ND</b>	6	3,000k	480	80	1.69
<b>A199E26830ND</b>	9	3,000k	800	80	1.99

Catalog Numbers Listed are 3,000k (30). Replace 30 with 27 for 2,700k or 50 for 5,000k.

LED REFLECTOR LAMPS

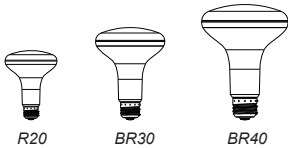

Vendor Code: **RAB**

Catalog Number	Watts	Color	Lumens	CRI	Price Each
<b>R20</b>					
<b>R207830DIM</b>	7	3,000k	525	80	3.51
<b>BR30</b>					
<b>BR3010930DIM</b>	10	3,000k	700	90	5.69
<b>BR40</b>					
<b>BR4011930DIM</b>	11	3,000k	900	90	8.99

Catalog Numbers Listed are 3,000k (30). Replace 30 with 27 for 2,700k, 40 for 4,000k, or 50 for 5,000k.

LED PAR LAMPS

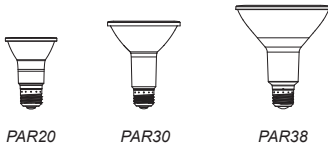

Vendor Code: **RAB**

Catalog Number	Watts	Color	Lumens	CRI	Price Each
<b>PAR20</b>					
<b>PAR20793040DDIM</b>	7	3,000k	550	90	7.44
<b>PAR30</b>					
<b>PAR30L1193035DDI</b>	11	3,000k	900	90	10.69
<b>PAR38</b>					
<b>PAR381583040DDIM</b>	15	3,000k	1,050	80	12.13
<b>PAR381583025DDIM</b>	15	3,000k	1,050	80	12.13

Catalog Numbers Listed are 3,000k (30). Replace 30 with 27 for 2,700k, 40 for 4,000k, or 50 for 5,000k.  
 \*40° Beam Angle  
 \*\*25° Beam Angle

LED MR16 LAMPS

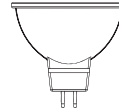

Vendor Code: **RAB**

Catalog Number	Watts	Color	Lumens	Beam Angle	Price Each
<b>MR16683035DDIM</b>	6.5	3,000k	450	35°	5.25
<b>MR16993025DDIM</b>	9	3,000k	565	25°	7.99
<b>MR16993035DDIM</b>	9	3,000k	565	35°	7.99

Catalog Numbers Listed are 3,000k (30). Replace 30 with 27 for 2,700k, 40 for 4,000k, or 50 for 5,000k.

LED DECORATIVE LAMPS

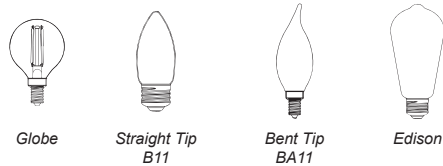

Vendor Code: **RAB**

Catalog Number	Watts	Color	Lumens	Base	Price Each
<b>GLOBES</b>					
<b>G16.53E12927FC</b>	3.8	2,700k	350	Candelabra	3.78
<b>G253E26927FC</b>	3.8	2,700k	350	Medium	4.00
<b>STRAIGHT TIP B11</b>					
<b>B113E26927FC</b>	3.3	2,700k	300	Medium	3.63
<b>BENT TIP BA11</b>					
<b>BA115E12927FC</b>	5.5	2,700k	500	Candelabra	3.93
<b>EDISON</b>					
<b>ST193E26927FC</b>	3.8	2,700k	350	Medium	4.75



Lighting & Lighting Controls



## Lighting Accessories (Lamp Sockets · Sockets · Lamp Guards · Toggle Switches)

### LAMP SOCKETS

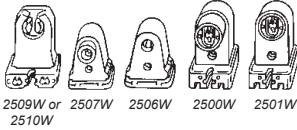

Vendor Code: **EWD**

Catalog Number	Description	Price per 100 pcs.
<b>MEDIUMBI-PIN, FLUORESCENT QUICKWIRE</b>		
2509WB0X	White, Tall	132.84
2510WB0X	White, Short	137.13
<b>SLIMLINE FLUORESCENT</b>		
2507WB0X	Plunger End	355.12
2506WB0X	Fixed End	309.40
<b>800 &amp; 1500MA, 2 TERM (HO, SHO &amp; VHO)</b>		
2500WB0X	Fixed End	685.98
2501WB0X	Plunger End	801.91

### STRIP CONVERSION KITS

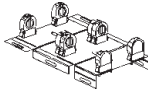

Vendor Code: **EPC**

Catalog Number	Converts To:	Price Each
14050	4 Lamp T8	17.49

\*Lamps and Ballast Not Included. Converts from 8" to 4".

### PLASTIC FLUORESCENT TUBE GUARDS



Vendor Code: **EPC**

Catalog Number	Description	Price per 100 pcs.
<b>T12 TUBE GUARDS</b>		
17060	4' Tube Guard	227.99
17090	8' Tube Guard	496.99
<b>T8 TUBE GUARDS</b>		
17000	4' Tube Guard	349.99
17030	8' Tube Guard	528.99

Includes Black Plastic End Caps

### LAMP GUARDS



Vendor Code: **EPC** (Engineered Prod. Co. - EPCO)

Catalog Number	Description	Carton Quantity	Price per 100 pcs.
16100	Yellow Plastic	10	327.97

Vendor Code: **EWD** (Eaton Wiring Devices)

Catalog Number	Description	Carton Quantity	Price per 100 pcs.
469BB0X	Wire Guard	60	9.72

### LIGHT RECEPTACLES

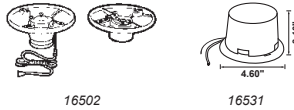

Vendor Code: **EPC**

Catalog Number	Description	Price per 100 pcs.
16502	Porcelain Lamp Holder: Pull Chain	429.97
16500	Porcelain Lamp Holder: Keyless	289.59
16512	Plastic Lamp Holder: Pull Chain	497.86
16510	Plastic Lamp Holder: Keyless	357.98

	Price Each	
16531	LED GU24: Keyless	24.37

Popular Fixtures Indicated In Bold.

### TEMPORARY LIGHTING STRING



Vendor Code: **COR**

Catalog Number	Description	Price Each
7145SW	14/2, 100' String	103.34

### BUTTON SWITCH



Vendor Code: **LCP**

Catalog Number	Description	Price Each
8410K1	Closet Door Switch	5.79

### SOCKETS

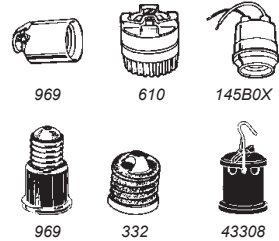

Vendor Code: **EWD** (Eaton Wiring Devices)

Catalog Number	Description	Ctn. Qty.	Price Each
<b>MEDIUM BASE</b>			
969B0X	Porcelain	25	7.73
610B0X	Porcelain Sign Receptacle	25	5.84
145B0X	Weatherproof Rubber	25	4.14
<b>SOCKET ADAPTERS</b>			
1054B0X	Socket Extension	25	3.98
332B0X	Mogul to Medium	25	3.96

Vendor Code: **PAS** (Pass and Seymour Legrand)

Catalog Number	Description	Ctn. Qty.	Price per 100 pcs.
43308	Temporary Lighting Device	25	365.99

### GENERAL DUTY TOGGLE SWITCHES

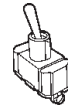

Vendor Code: **CHC**

Catalog Number	Amps	Poles	Position Types	Throw Type	Price Each
E10T115AS	15	Single	On/Off	Single	8.73
E10T106DS	6	Single	On/Off/On	Double	10.28
E10T115DS	15	Single	On/Off/On	Double	10.72
E10T106ES	6	Single	On/On	Double	10.72
E10T215DS	15	Double	On/Off/On	Double	12.37
E10T215ES	15	Double	On/On	Double	10.12



Lighting & Lighting Controls



LED Lamps (Replacement Tubes · PAR · A-Line · Reflector)

LED REPLACEMENT TUBES  
BALLAST COMPATIBLE

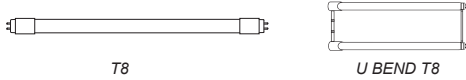

Vendor Code: GEL

Catalog Number	Watts	Size	Lumens	Kelvin	Rated Life (h)	Price Each
<b>GLASS, ECONOMY LINEAR T8 (NON-DLC)</b>						
LED15ET8840V6P	15	48"	1,800	4,000K	36,000	11.29
LED15ET8835V6P	15	48"	1,800	3,500K	36,000	11.29
LED15ET8850V6P	15	48"	1,800	5,000K	36,000	11.29
<b>GLASS, LINEAR T8</b>						
LED15ET8G4830	15	48"	1,800	3,000K	50,000	11.07
LED15ET8G4835	15	48"	1,800	3,500K	50,000	11.07
LED15ET8G4840	15	48"	1,800	4,000K	50,000	11.07
LED15ET8G4850	15	48"	1,800	5,000K	50,000	11.07
<b>PLASTIC, U BEND T8</b>						
LED13ET8U6835	13	22.5"	1,850	3,500K	50,000	18.78
LED13ET8U6840	13	22.5"	1,900	4,000K	50,000	18.78
LED13ET8U6850	13	22.5"	1,900	5,000K	50,000	18.78

80+ CRI

DOUBLE ENDED DIRECT WIRE 120-277V

Vendor Code: GEL

Catalog Number	Watts	Size	Lumens	Kelvin	Rated Life (h)	Price Each
LED14BDT8G4830	14	48"	1,700	3,000K	50,000	9.65
LED14BDT8G4835	14	48"	1,750	3,500K	50,000	9.65
LED14BDT8G4840	14	48"	1,800	4,000K	50,000	9.65
LED14BDT8G4850	14	48"	1,850	5,000K	50,000	9.65

LED PAR LAMPS



Vendor Code: GEL

Catalog Number	Watts	Lumens	Color	CRI	Rated Life (h)	Price Each
<b>PAR30</b>						
LED12DP30RW82740	12	1,000	2,700K	80	25,000	22.97
<b>PAR 38</b>						
LED18D380W383025	18	1,550	3,000K	81	25,000	27.04
LED18D380W383040	18	1,550	3,000K	81	25,000	27.04

LED A-LINE LAMPS



GE offers dimmable LED A-Line lamps as excellent replacements for standard 25-watt, 40-watt, 60-watt, 75-watt and 100-watt incandescent lamps.

- Energy efficiency and long life mean fewer lamp replacements versus standard incandescent or halogen light sources.
- Dims from 100% to as low as 10%.
- Available with a CRI of 78 - 84.

Vendor Code: GEL

Catalog Number	Watts	Lumens	Color	CRI	Rated Life (h)	Price Each
<b>A19 40W REPLACEMENT</b>						
LED6DA19827	6	480	2,700K	80	15,000	6.87
<b>A19 60W REPLACEMENT</b>						
LED10DA19827	10	800	2,700K	80	15,000	8.07
<b>A21 75W REPLACEMENT</b>						
LED12DA21827	12	1,100	2,700K	80	15,000	9.47
<b>A21 100W REPLACEMENT</b>						
LED15DA21827	15	1,600	2,700K	80	15,000	12.99

Catalog Numbers Listed are 2,700K (27). Replace 27 with 30 for 3,000K, 40 for 4,000K and 50 for 5,000K.

LED REFLECTOR LAMPS



Vendor Code: GEL

Catalog Number	Watts	Lumens	Color	CRI	Rated Life (h)	Price Each
<b>R20</b>						
LED7DR20827	7	470	2,700	80	25,000	8.79
<b>BR30</b>						
LED10DR303827W	10	700	2,700	80	25,000	9.98
<b>BR40</b>						
LED13DBR40827	13	1,070	2,700	80	25,000	14.97

Catalog Numbers Listed are 2,700K (27). Replace 27 with 30 for 3,000K, 40 for 4,000K and 50 for 5,000K.



Genuine GE Lamps

Lighting & Lighting Controls



## LED Lamps (Bright Stik™ · HID Replacements · CFL Plug-In Replacements · Decorative)

### LED BRIGHT STIK™ BULBS



Vendor Code: **GEL**

Catalog Number	Watts	Lumens	Color	LPW	Typically Replaces	Price Each
<b>LED9LS3827*</b>	9	800	2,700K	89	60W	9.95
<b>LED12LS2827**</b>	12	1,100	2,700K	91	75W	12.72
<b>LED15LS2827**</b>	15	1,600	2,700K	107	100W	15.01

\*Pack of Three

\*\*Pack of Two

Other Color Temperatures are Available. Replace the Two Black Numbers with **27** for 2,700K, **28** for 2,850K, or **50** for 5,000K.

### LED HID REPLACEMENT LAMPS

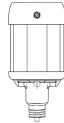

Vendor Code: **GEL**

Catalog Number	Watts	Lumens	Color	LPW	Typically Replaces	Price Each
<b>BALLAST BYPASS 120-277V</b>						
<b>LED50ED23.5750</b>	50	7,500	5,000K	150	100W	75.08
<b>LED80ED23.5750</b>	80	12,000	5,000K	150	175W	133.33
<b>LED115ED28750</b>	115	18,000	5,000K	156	250W	156.58
<b>LED150ED28750</b>	150	23,500	5,000K	140	400W	200.00
<b>BALLAST BYPASS 277-480V</b>						
<b>LED270BT56750</b>	270	40,000	5,000K	148	1,000W	418.97
<b>LED450BT56750</b>	450	65,000	5,000K	144	1,000W	379.00
<b>BALLAST COMPATIBLE</b>						
<b>LED602M175750*</b>	60	8,800	5,000K	147	175W	162.44
<b>LED802M250750*</b>	80	11,800	5,000K	148	250W	170.98
<b>LED1302M400750*</b>	130	18,500	5,000K	142	400W	174.99

Catalog Numbers Listed are 5,000K. Replace **50** with **40** for 4,000K.

Open or Enclosed Rated.

Fit ANSI Profile of Lamps Being Replaced.



Genuine GE Lamps

### LED 4-PIN CFL REPLACEMENTS



Horizontal



Vertical

GE's LED plug-in lamps allow you to replace inefficient CFL 4 pin G24q/GX24 without tools or costly upgrades. Simply plug the replacement lamp into the existing ballast.

- Uses 50% less energy than CFL
- With LED CFL Replacements you can save over \$100 in energy costs vs. CFL over the rated life of the lamp (based on \$0.12 per kWh)
- 50,000 Hour Rated Life
- CFL could need replacement up to four times before you would have to replace a single LED Plug-In

Vendor Code: **GEL**

Catalog Number	Watts	Lumens	Color	LPW	Typically Replaces	Price Each
<b>HORIZONTAL WITH ROTATABLE BASE</b>						
<b>LED9G24QH840*</b>	9	1,200	4,000K	133	26W	15.00
<b>LED19GX24QH840</b>	18.5	1,950	4,000K	105	42W	26.38
<b>VERTICAL</b>						
<b>LED9G24QV840*</b>	9	1,200	4,000K	133	26W	15.00
<b>LED19GX24QV840</b>	18.5	1,950	4,000K	105	42W	26.38

Catalog Numbers Listed are 4,000K (**40**). Replace **40** with **27** for 2,700K, **30** for 3,000K, and **35** for 3,500K.

\*G24q/GX24q Base

### LED DECORATIVE LAMPS GLOBES



GE LEDs offer outstanding energy efficiency, long-lasting performance and just-right brightness, all in one package. They're dimmable and illuminate your home with soft, warm light.

- 15,000 Hour Rated Life
- Available with a CRI of 80

Vendor Code: **GEL**

Catalog Number	Watts	Lumens	Color	LPW	Typically Replaces	Price Each
<b>LED5DG25W3827</b>	5	350	2,700K	70	40	7.97
<b>LED7DG25W3827</b>	7	500	2,700K	71	60	9.45

Catalog Numbers Listed are 2,700K (**27**). Replace **27** with **30** for 3,000K, and **35** for 3,500K.

**LED Lamps (Compact PAR20 · Dimmable Candle · Directional · Vintage/Filament Style)**

**LED COMPACT PAR20 LAMPS**



For hard-to-reach downlight application fixtures, GE's dimmable 7-watt LED PAR20 lamp is the ideal solution.

- For example, using only 7 watts of energy, save over \$236 in energy costs over the life of the lamp versus a standard 35-watt halogen lamp based on \$0.11 per kWh.
- Energy efficiency and long life mean fewer lamp replacements versus standard incandescent or halogen light sources.

Vendor Code: **GEL**

Catalog Number	Watts	Lumens	Color	CRI	Beam Angle	Price Each
<b>NARROW FLOOD</b>						
<b>LED7DP203B83020</b>	50	520	3,000K	80	20°	15.88
<b>FLOOD</b>						
<b>LED7DP203W83035</b>	50	520	3,000K	80	35°	15.88

B=Black Casing  
W=White Casing  
Catalog Numbers Listed are 3,000K (30). Replace 30 with 27 for 2,700K, 25,000 Hour Rated Life

**LED DIMMABLE CANDLE LAMPS**



For any decorative lighting application, GE's LED dimmable candle lamps are the perfect solution and offer a multitude of wattage options.

- For example, using only 2.2 watts of energy, save over \$21 in energy costs over the rated life of a lamp versus a standard 15-watt incandescent lamp based on \$0.11 per kWh.
- Energy efficiency and long life mean fewer lamp replacements versus standard incandescent and halogen light sources.

Vendor Code: **GEL**

Catalog Number	Base	Watts	Lumens	Color	CRI	Rated Life (h)	Price Each
<b>40W INCANDESCENT EQUIVALENT</b>							
<b>LED4DCACC3827</b>	Cand	4	300	2,700K	80	15,000	6.86
<b>LED4DCAMC3827</b>	Med	4	300	2,700K	80	15,000	6.86
<b>60W INCANDESCENT EQUIVALENT</b>							
<b>LED7DCACC3827</b>	Cand	7	500	2,700K	80	15,000	9.45
<b>LED7DCAMC3827</b>	Med	7	500	2,700K	80	15,000	9.45

Catalog Numbers Listed are 2,700K (27). Replace 27 with 50 for 5,000K.



Genuine GE Lamps

**LED DIRECTIONAL LAMPS**

MR16

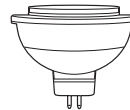

LED7DMR1683015

For high-output in decorative lighting applications, GE's dimmable 7-watt LED MR16 lamp is the perfect solution.

- For example, using only 7 watts of energy, save over \$118 in energy costs over the rated life of a lamp versus a standard 50-watt halogen lamp based on \$0.11 per kWh.
- Energy efficiency and long life mean fewer lamp replacements versus halogen MR16/MRX16 light sources.
- Available in 15°, 25°, and 35° beam patterns

Vendor Code: **GEL**

Catalog Number	Watts	Lumens	Color	CRI	Beam Angle	Price Each
<b>35W INCANDESCENT EQUIVALENT</b>						
<b>LED7DMR16S83015</b>	7	460	3,000K	80	15°	15.54
<b>50W INCANDESCENT EQUIVALENT</b>						
<b>LED7XDMRX1683025</b>	7	520	3,000K	80	25°	17.97
<b>LED7XDMRX1683035</b>	7	520	3,000K	80	35°	17.97

25,000 Hour Rated Life  
Catalog Numbers Listed are 3,000K (30). Replace 30 with 27 for 2,700K.

**LED VINTAGE/FILAMENT STYLE**

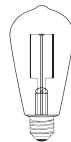

GE LED Vintage Style lamps combine the retro look of antique incandescent lamps with the benefits of LED. A warm, candlelight glow is provided by the LED filament, and the golden-tinted glass gives the lamp a vintage look. The long life and low energy of LED create savings on energy usage and maintenance costs versus incandescent.

- Common applications include pendants, sconces, chandeliers and other decorative fixtures.
- Perfect for creating an inviting atmosphere in restaurants and hotels, as well as adding vintage accents in retail and office locations.

Vendor Code: **GEL**

Catalog Number	Watts	Lumens	Color	Wattage Equivalent	Rated Life (h)	Price Each
<b>LED3DST19V</b>	3	200	2,500K	25W	15,000	9.97
<b>LED3DCAMV</b>	3.5	300	2,500K	40W	15,000	9.97



Lighting & Lighting Controls



### A-LINE LAMPS



Vendor Code: **GEL**

Catalog Number	Watts	Volts	Base	Color	Price Each
<b>72AWH2PK120*</b>	72	120	Medium	Soft White	4.99

Halogen Lamp

### REFLECTOR LAMPS

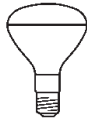

Vendor Code: **GEL**

Catalog Number	Watts	Volts	Base	Shape	Price Each
<b>45R20130VPR0130</b>	45	130	Medium	R20	2.59
<b>65BR30PR0130</b>	65	130	Medium	BR30	2.07
<b>65BR40FLPR0130</b>	65	130	Medium	BR40	4.68

Popular Lamps Indicated in Bold

### PAR LAMPS

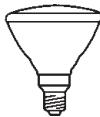

Vendor Code: **GEL**

Catalog Number	Watts	Volts	Base	Type	Price Each
<b>38PAR20HFL25</b>	38	120	Medium	PAR20	7.35
<b>38PAR30HFL25</b>	38	120	Medium	PAR30	7.27
<b>60PARH1500FL25TP</b>	60	120	Medium	PAR38	8.49

Popular Lamps Indicated in Bold

NOTE: 130V lamps last 3 times as long as 120V lamps at the socket voltage.



Genuine GE Lamps

### EXIT SIGN TUBULAR LAMPS



Vendor Code: **GEL**

Catalog Number	Watts	Volts	Base	Color	Price Each
<b>25T6.5CLPR0</b>	25	130	Intermediate	Clear	2.67

### QUARTZ LAMPS



Vendor Code: **GEL**

Catalog Number	Watts	Volts	Length	Price Each
<b>Q500T3CLPR0130</b>	500	130	4-11/16"	3.79
<b>Q1500T3CLPR0240</b>	1,500	240	10-1/16"	9.76

Popular Lamps Indicated in Bold

### APPLIANCE LAMPS



Vendor Code: **GEL**

Catalog Number	Watts	Volts	Base	Color	Price Each
<b>40A15CLPR0130</b>	40	130	Medium	Clear	0.99

Popular Lamps Indicated in Bold

### HALOGEN PRECISE LAMPS



Vendor Code: **GEL**

Catalog Number	Watts	Volts	Type	Price Each
<b>Q50MR16FL</b>	50	12	Flood	7.99

Lighting & Lighting Controls



Linear Fluorescent Lamps (T8 Tubes · T5 Tubes · U Shaped · T12 Tubes)

T8 TUBES

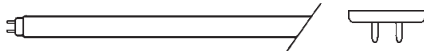

Vendor Code: **GEL**

Catalog Number	Watts	Length	Lumens	Color	CRI	Rated Life (h)	Price Each
<b>RAPID START</b>							
<b>F17T8SP41ECO</b>	17	24"	1,260	4,100K	78	24,000	3.65
<b>F25T8SP41ECO</b>	25	36"	1,970	4,100K	78	24,000	3.81
<b>F32T8SPX41ECO2</b>	32	48"	2,925	4,100K	80	30,000	3.53

Rated Life at 12 Hour Cycles  
Popular Lamps Indicated in Bold

T5 TUBES

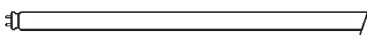

Vendor Code: **GEL**

Catalog Number	Watts	Length	Lumens	Color	CRI	Rated Life (h)	Price Each
<b>HIGH OUTPUT</b>							
<b>F54WT5850ECO**</b>	54	45.2"	4,600	5,000K	85	36,000	6.18

\*Starter Required  
\*\*5/8" Diameter  
Popular Lamps Indicated in Bold

U SHAPED FLUORESCENT LAMPS

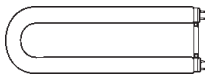

Vendor Code: **GEL**

Catalog Number	Watts	Length	Lumens	Color	CRI	Rated Life (h)	Price Each
<b>T8 - 6" SPACING</b>							
<b>F32T8SPX41U62</b>	32	22.5"	2,630	4,100K	82	20,000	10.95

Popular Lamps Indicated in Bold



Genuine GE Lamps

T12 TUBES

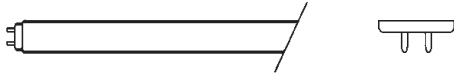

Vendor Code: **GEL**

Catalog Number	Watts	Length	Lumens	Color	CRI	Rated Life (h)	Price Each
<b>RAPID START</b>							
<b>F34CWCWMECO</b>	34	48"	1,500	4,100K	87	15,000	2.79
<b>F40DXECO</b>	40	48"	1,740	6,500K	90	20,000	3.98

\*Starter Required  
Popular Lamps Indicated in Bold

INSTANT START

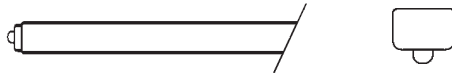

Vendor Code: **GEL**

Catalog Number	Watts	Length	Lumens	Color	CRI	Rated Life (h)	Price Each
<b>F96T12CWCWM</b>	60	96"	2,900	4,100K	90	12,000	5.97

Popular Lamps Indicated in Bold

T12 HIGH OUTPUT



Vendor Code: **GEL**

Catalog Number	Watts	Length	Lumens	Color	CRI	Rated Life (h)	Price Each
<b>F48T12CWHO</b>	60	48"	3,520	4,100K	60	12,000	9.89
<b>F72T12CWHO</b>	85	72"	5,520	4,100K	60	12,000	9.97
<b>F96T12CWHOCT*</b>	110	96"	7,740	4,100K	60	12,000	10.22
<b>F96T12HL41H0WM</b>	95	96"	7,920	4,100K	77	12,000	10.67

Popular Lamps Indicated in Bold  
\*For Cold Temperature Use

Lighting & Lighting Controls

C





## Metal Halide Lamps (Pulse Start · Probe Start) · Biax Lamps

### PULSE START METAL HALIDE LAMPS

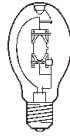

Vendor Code: **GEL**

Catalog Number	Watts	Base	Bulb Descr.	Light Output Initial/Mean	Rated Life (h)	Price Each
<b>MVR320VBUH0PA</b>	320	Mog.	Clear	31,000/18,000	20,000	33.92
<b>MVR400UPA</b>	400	Mog.	Clear	38,000/22,000	18,000	34.29

Light Output and Rated Life Based On Base Up Installation  
Popular Lamps Indicated in Bold

### PROBE START METAL HALIDE LAMPS



- Probe start lamps used with pulse start ballasts will damage the lamp and ballast.

Vendor Code: **GEL**

Catalog Number	Watts	Base	Bulb Descr.	Light Output Initial/Mean	Rated Life (h)	Price Each
<b>MVR175UMED</b>	175	Med.	Clear	13,600/8,800*	10,000	24.97
<b>MVR175U</b>	175	Mog.	Clear	13,600/8,800*	10,000	22.15
<b>MVR250U</b>	250	Mog.	Clear	20,800/13,500*	10,000	23.61
<b>MVR400U</b>	400	Mog.	Clear	36,000/23,500*	20,000	25.28
<b>MVR1000U</b>	1,000	Mog.	Clear	110,000/88,000*	15,000	40.70
<b>MVR1500USP0RTS</b>	1,500	Mog.	Clear	170,000/153,000*	3,000	58.01

\*Light Output and Rated Life Based on Base Up Installation  
Popular Lamps Indicated in Bold

### HIGH PRESSURE SODIUM LAMPS

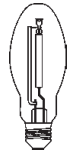

Vendor Code: **GEL**

Catalog Number	Watts	Base	Bulb Descr.	Light Output Initial/Mean	Rated Life (h)	Price Each
<b>LU15055HEC0</b>	150	Mog.	Clear	16,000/14,400	24,000+	18.93
<b>LU250HEC0</b>	250	Mog.	Clear	28,000/27,000	24,000+	19.17
<b>LU400HEC0</b>	400	Mog.	Clear	51,000/45,000	24,000+	19.49

Popular Lamps Indicated in Bold



Genuine GE Lamps

### TRIPLE BIAX - 4 PIN

FOR DIMMING AND ELECTRONIC BALLAST



GX24Q-3



GX24Q-4

Vendor Code: **GEL**

Catalog Number	Watts	Length	Base	Lumens	Color	Rated Life (h)	Price Each
<b>F32TBX841AEC0</b>	32	5.5"	G24Q-3	1,850	4,100K	12,000	9.99
<b>F42TBX841AEC0</b>	42	6.4"	G24Q-4	2,690	4,100K	12,000	9.89

Popular Lamps Indicated in Bold

### DOUBLE BIAX - 2 PIN WITH STARTER IN LAMP BASE FOR MAGNETIC BALLAST



G24D-3

Vendor Code: **GEL**

Catalog Number	Watts	Length	Base	Lumens	Color	Rated Life (h)	Price Each
<b>F26DBX835EC0</b>	26	6.67"	G24D-3	1,460	3,500K	10,000	8.99

### DOUBLE BIAX 4 PIN FOR DIMMING AND ELECTRONIC BALLAST



G24Q-1

Vendor Code: **GEL**

Catalog Number	Watts	Length	Base	Lumens	Color	Rated Life (h)	Price Each
<b>F13DBX841EC04P</b>	13	4.9"	G24Q-1	755	4,100K	17,000/20,000	8.39



Lighting & Lighting Controls

LED Lamps (A-Line · Dimmable · T8 Tubes · T5 HO Tubes · PAR)

LED A-LINE LAMPS

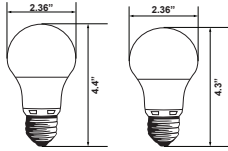

Vendor Code: SYL

Catalog Number	Watts	Type	Color	Lumens	LPW	Rated Life (h)	Price Each
<a href="#">LED8.5A19F85010Y</a>	8.5	A19	5,000K	800	94	11,000	2.97
<a href="#">LED14A19F85010YV</a>	14	A19	5,000K	1,500	107	11,000	6.99

Non-Dimmable  
Catalog Numbers Listed are 5,000K (50). Replace 50 with 27 for 2,700K, or 35 for 3,500K.

DIMMABLE LED A-LINE LAMPS

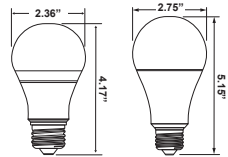

Vendor Code: SYL

Catalog Number	Watts	Type	Color	Lumens	LPW	Replaces	Price Each
<a href="#">LED9A19DIM0830UR</a>	9	A19	3,000K	800	89	60W Incan.	3.67
<a href="#">LED16A21DIM0850</a>	16	A21	5,000K	1,600	100	100W Incan.	6.97

Other Color Temperatures are Available. Replace the Two Black Numbers with 27 for 2,700K, 28 for 2,850K, or 50 for 5,000K.

LED T8 TUBES



Vendor Code: SYL

Catalog Number	Watts	Size	Color	Lumens	LPW	Rated Life (h)	Price Each
<b>BALLAST COMPATIBLE</b>							
<a href="#">LED17T8L48FGIS85</a>	17	48"	5,000K	2,220	129	36,000	8.97
<a href="#">LED17T8L48FGIS84</a>	18	48"	4,000K	2,220	129	36,000	8.97
<b>120-277V (SINGLE OR DOUBLE ENDED)</b>							
<a href="#">LED17T8L48850BF</a>	17	48"	5,000K	2,220	129	50,000	10.95
<a href="#">LED17T8L48841BF</a>	17	48"	4,100K	2,220	129	50,000	10.95

Frosted Glass  
Other Color Temperatures are Available. Replace the Two Black Numbers with 30 for 3,000K, 35 for 3,500K, 41 for 4,100K or 50 for 5,000K.

SUBSTITUTE® LED T5HO LAMPS  
REPLACEMENT FOR FLUORESCENT T5HO LAMPS



Vendor Code: SYL

Catalog Number	Watts	Size	Color	Lumens	LPW	Rated Life (h)	Price Each
<a href="#">LED25T5H0L48FG84</a>	25	48"	4,000K	3,500	140	50,000	18.99

Frosted Glass  
Other Color Temperatures are Available. Replace 5 with 3 for 3,000K, 35 for 3,500K, or 4 for 4,000K.

LED PAR LAMPS

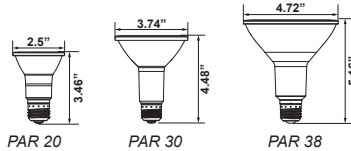

Vendor Code: SYL

Catalog Number	Watts	Lumens	Color	CRI	Beam Spread	Rated Life (h)	Price Each
<b>PAR 20</b>							
<a href="#">LED6PAR20830FL45</a>	6	425	3,000K	82	45°	11,000	6.29
<b>PAR 30</b>							
<a href="#">LED9PAR30LN830FL</a>	9	650	3,000K	82	45°	11,000	8.38
<b>PAR 38</b>							
<a href="#">LED13PAR38830FL4</a>	13	900	3,000K	82	45°	11,000	10.49

Medium Base  
Non-Dimmable  
PAR 38 also Available in 5,000K. Replace 30 with 50 for 5,000K.

DIMMABLE LED PAR LAMPS

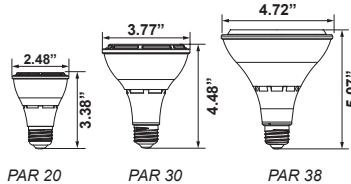

Vendor Code: SYL

Catalog Number	Watts	Lumens	Color	CRI	Beam Spread	Replaces	Price Each
<b>PAR 20</b>							
<a href="#">LED7PAR20DIM830</a>	7	525	3,000K	82	40°	50w Hal.	12.99
<b>PAR 30</b>							
<a href="#">LED12.5PAR30LN30</a>	12.5	1,000	3,000K	91	40°	75w Hal.	17.49
<b>PAR 38</b>							
<a href="#">LED16PAR38DIM850</a>	16	1,300	5,000K	82	40°	125w Hal.	18.37

Medium Base  
Other Color Temperatures are Available. Replace the Two Black Numbers with 27 for 2,700K, 30 for 3,000K, or 50 for 5,000K.





## LED Lamps (Dimmable · Reflector · MR16 · Filament · Vintage)

### DIMMABLE LED REFLECTOR LAMPS CONTRACTOR SERIES

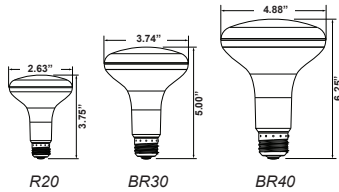

Rated up to 11,000 hours at 70% lumen maintenance, Contractor Series LED reflector lamps offer years of service and reduce energy and maintenance costs. Contractor Series LED reflector lamps are environmentally preferred products. They are RoHS compliant and contain no mercury, lead or other hazardous materials. They emit no UV or IR radiation.

Vendor Code: SYL

Catalog Number	Watts	Lumens	Color	CRI	Rated Life (h)	Price Each
<b>R20</b>						
LED5R20DIM82710Y	5	325	2,700K	80	11,000	4.97
<b>BR30</b>						
LED9BR30DIM82710	9	650	2,700K	80	11,000	6.29
<b>BR40</b>						
LED13BR40DIM8271	13	900	2,700K	80	11,000	10.48

Medium Base

Catalog Numbers Listed are 2,700K (27). Replace 27 with 35 for 3,500K or 50 for 5,000K.

### DIMMABLE LED MR16 LAMPS

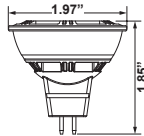

Long lasting, energy efficient, ULTRA LED MR16 lamps are now true halogen equivalent lamps when comparing lumen output and center beam candlepower. MR16 lamps are available in 6, 8 and 9W versions in 25° and 35° beam angles and are high-quality replacements for halogen 20W-50W MR16 lamps. These LED MR16 lamps are available in GU5.3 base configurations and dimmable down to 10%. Lamps boast a 25,000 hours life (L70) providing 12.5 times longer life than halogen MR16 lamps thereby reducing maintenance costs. Lamps have a 3,000K color temperature similar to halogen and 80+ CRI. These products are free of UV and IR radiation, minimizing discoloration and fading of materials.

Vendor Code: SYL

Catalog Number	Watts	Lumens	Color	Beam Angle	Rated Life (h)	Price Each
LED6MR16DIM830F	6	450	3,000K	35°	25,000	7.59
LED6MR16DIM830NF	6	450	3,000K	25°	25,000	7.59



### DIMMABLE LED FILAMENT LAMPS

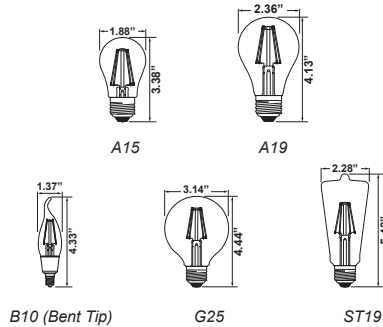

Rated up to 15,000 hours at 70% lumen maintenance, SYLVANIA ULTRA LED filament lamps offer years of service and reduce energy and maintenance costs. SYLVANIA ULTRA LED filament lamps are environmentally preferred products. They are RoHS compliant and contain no mercury, lead or other hazardous materials. They emit no UV or IR radiation. A CRI of 80 ensures good color definition and with warm white 2,700K color temperature, these lamps can be used in many applications in both homes and businesses.

Vendor Code: SYL

Catalog Number	Watts	Lumens	Color	CRI	Rated Life (h)	Price Each
LED5A15DIMCL927C	5	450	2,700K	90	15,000	4.58
LED5A19DIM0927CE	5	450	2,700K	90	15,000	5.06
LED4B10CBENTDIM9	4	320	2,700K	90	15,000	4.77
LED4.5G25CLDIM92	4.5	350	2,700K	90	15,000	5.91
LED5ST19DIM827CE	5	450	2,700K	90	15,000	5.45

\*Medium Base Clear Finish

\*\*Candelabra Clear Finish

### LED VINTAGE LAMPS

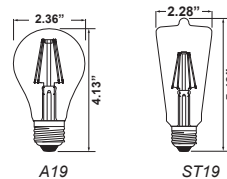

Rated up to 15,000 hours at 70% lumen maintenance, SYLVANIA LED Vintage lamps offer years of service and reduce energy and maintenance costs. They are RoHS compliant and contain no mercury, lead or other hazardous materials.

Vendor Code: SYL

Catalog Number	Watts	Lumens	Color	CRI	Rated Life (h)	Price Each
LED6.5A19DIM822V	6.5	650	2,175K	80	15,000	6.67
LED6.5ST19DIM822	6.5	650	2,200K	80	15,000	7.99
LED4B10CBENTDIM8	4	360	2,175K	80	15,000	5.99

Amber Finish

Lighting & Lighting Controls

LED Lamps (High Lumen · U Shaped · TT5 · Pin Base)

ULTRA LED™ HIGH LUMEN LAMPS

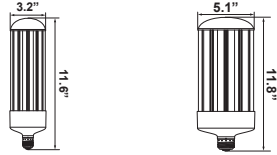

LEDHIDR5000850

LED80HIDR8000840

The SYLVANIA ULTRA LED high lumen lamp is a self-ballasted medium base HID replacement lamp. The lamp is easy to install and is ideal for indoor high/low bay lighting and outdoor decorative post top fixtures in walkway lighting applications. This lamp provides excellent color rendering (82 CRI) in comparison with traditional high pressure sodium and metal halide lamps, and a selection of color temperatures (2,700K, 3,000K, 4,000K and 5,000K). The optical design efficiently directs light output in a 360° (horizontal) beam angle (or omnidirectional) with Type V distribution.

Vendor Code: SYL

Catalog Number	Watts	Color	Lumens	LPW	Rated Life (h)	Price Each
<b>LED HID REPLACEMENTS, E26 BASE</b>						
LEDHIDR5000850*	55	5,000K	5,000	100	50,000	143.97
LED80HIDR8000840**	80	4,000K	8,000	100	50,000	219.97
<b>LED HID REPLACEMENT ACCESSORY</b>						
LEDADAPTORM0GULB	Mogul Base Adaptor for E26 Base					7.58

\*Catalog Number Listed above is 5,000K (50). Replace 50 with 30 for 3,000K and 40 for 4,000K.  
 \*\*Catalog Number Listed above is 4,000K (40). Replace 40 with 30 for 3,000K.

U SHAPED LED LAMPS  
SUBSTITUBE® CURVALUME® IPS LED T8

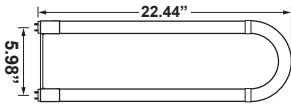

SYLVANIA SubstiTUBE CURVALUME IPS LED T8 lamps are an energy saving alternative, designed to replace traditional fluorescent T8 lamps. These shatter-resistant LED T8 lamps contain no mercury, provide instant light and a uniform light distribution.

Engineered to operate on existing instant start and select programmed rapid start electronic T8 ballasts, these lamps minimize labor and recycling costs. Because the SubstiTUBE CURVALUME IPS LED T8 is not affected by switching cycles, the use of occupancy or vacancy sensors can be installed with the existing instant start ballasts for optimal energy savings.

Install a new QHE Instant start ballast with the SubstiTUBE CURVALUME IPS LED T8 lamp for optimal performance and to take advantage of the QUICK 72SUB-System warranty.

Vendor Code: SYL

Catalog Number	Watts	Color	Lumens	LPW	Rated Life (h)	Price Each
<b>6" LEG SPACE</b>						
LED15T8UF935SUB	15	3,500K	2,100	147	50,000	23.65

Catalog Number Listed Above is 3,500K (35). Replace 35 with 30 for 3,000K, 41 for 4,100K and 50 for 5,000K.

TT5 LED LAMPS  
SUBSTITUBE® DULUX® L LED

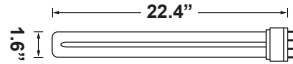

Energy efficient 50,000 hour LED TT5 lamps providing instant light and a uniform light distribution with an optimized glass design. These lamps contain no mercury, provide instant light and a uniform light distribution. They are engineered to operate on existing instant start electronic DL40 ballasts.

Vendor Code: SYL

Catalog Number	Watts	Color Temp.	Lumens (Mean)	LPW	Rated Life (h)	Price Each
LED17TT5DLFG841S	17	4,100K	2,200	130	50,000	21.99

Catalog Number Listed above is 4,100K (41). Replace 41 with 30 for 3,000K and 35 for 3,500K.  
 2G11 Four Pin Base

PIN BASE LAMPS  
SUBSTITUBE® DULUX® LED

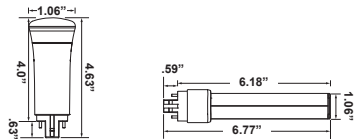

GX24Q

GX23

SubstiTUBE DULUX LED Pin Base lamps are direct replacements for compact fluorescent lamps. They can be directly installed without the need to bypass the existing CFL ballast. The lamps are available in GX23 and G24Q/GX24Q bases and in magnetic or electronic ballast configurations.

The LED pin base lamps have all the features of your typical LEDs, such as low heat emission and high energy efficiency, and a long rated life of 50,000 hours.

Vendor Code: SYL

Catalog Number	Watts	Color	Lumens	LPW	Rated Life (h)	Price Each
<b>VERTICAL</b>						
LED9PBGX24QV841*	9	4,100K	900	100	50,000	19.98
<b>HORIZONTAL</b>						
LED9PBGX24QH841*	9	4,100K	900	100	50,000	16.99
LED9PBGX23H841**	9	4,100K	1,100	122	50,000	17.97

\*GX24 Base  
 \*\*GX23 Base  
 Catalog Number Listed above is 4,100K (41). Replace 41 with 35 for 3,500K for the part numbers: LED9PBGX24QV841 and LED9PBGX24QH841.  
 Replace 41 with 27 for 2,700K for the part number: LED9PBGX23H841.





## "A" Lamps · Reflector · PAR Lamps · Halogen Lamps · Rapid Start Lamps

### "A" LAMPS

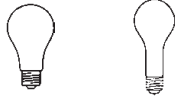

Vendor Code: SYL

Catalog Number	Watts	Base	Color	Price Each
<b>30MCL130V</b>	300	Med	Clear	9.78
<b>HALOGEN</b>				
<b>43AHALSSW4120V</b>	43	Med	Soft White	2.19
<b>72AHALSSW4120V</b>	72	Med	Soft White	2.19

### REFLECTOR LAMPS



Vendor Code: SYL

Catalog Number	Watts	Volts	Base	Shape	Price Each
<b>45R20CVP130V</b>	50	130	Med	R20	2.19
<b>65BR30FLCVP130V</b>	65	130	Med	BR30	2.67
<b>65BRFL130V</b>	65	130	Med	BR40	4.12
<b>250BR401*</b>	250	120	Med	BR40	6.97

\*Infrared Heat Lamp

### PAR LAMPS



Vendor Code: SYL

Catalog Number	Watts	Volts	Shape	Price Each
<b>HALOGEN FLOODS WITH MEDIUM BASE</b>				
<b>39PAR20HALFL3013</b>	39	130	PAR20	8.21
<b>50PAR30HALSNFL25</b>	50	120	PAR30	10.91
<b>70PAR38HALSNFL25</b>	70	120	PAR38	7.99

### DECORATIVE LAMPS WITH A BENT TIP



Vendor Code: SYL

Catalog Number	Watts	Volts	Base	Color	Price Each
<b>25B10CBL120V</b>	25	120	Cand	Clear	1.17

### HALOGEN LAMPS



Vendor Code: SYL

Catalog Number	Volts	Description	Beam Spread	Price Each
<b>50MR16FL35CEXN</b>	12	Reflector	35°	7.97

### T8 RAPID START MEDIUM BI PIN G13

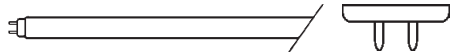

Vendor Code: SYL

Catalog Number	Watts	Length	Lumens	Color	CRI	Rated Life (h)	Price Each
<b>F017741ECO</b>	17	24"	1,170	4,100K	75	30,000	3.61
<b>F025741ECO</b>	25	36"	1,755	4,100K	75	30,000	3.99
<b>F032V41ECO</b>	32	48"	2,450	4,100K	90	22,500	2.99
<b>F032865XPECO</b>	32	48"	2,708	6,500K	85	40,000	5.72

Rated Life at 3 Hour Cycles

### T5 HIGH OUTPUT RAPID START MINIATURE BI PIN G5



Vendor Code: SYL

Catalog Number	Watts	Length	Lumens	Color	CRI	Rated Life (h)	Price Each
<b>FP54841HOECO</b>	54	45.8"	4,650	4,100K	82	20,000	4.29

### RAPID START MEDIUM BI PIN G13

Vendor Code: SYL

Catalog Number	Watts	Length	Lumens	Color	CRI	Rated Life (h)	Price Each
<b>F34CWSS</b>	34	48"	1,656	4,100K	87	20,000	3.17

### INSTANT START SINGLE PIN FA8

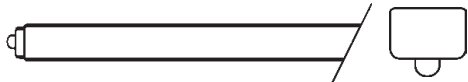

Vendor Code: SYL

Catalog Number	Watts	Length	Lumens	Color	CRI	Rated Life (h)	Price Each
<b>F96T12CWXX</b>	75	96"	3,872	4,100K	87	12,000	7.59
<b>F096841ECO</b>	59	96"	5,428	4,100K	82	15,000	12.45

### T12 HIGH OUTPUT RECESSED DOUBLE CONTACT R17D

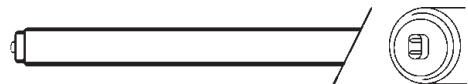

Vendor Code: SYL

Catalog Number	Watts	Length	Lumens	Color	CRI	Rated Life (h)	Price Each
<b>F48T12CWHO</b>	60	48	3,281	4,200K	60	12,000	5.62
<b>F72T12CWHO</b>	85	72	5,063	4,200K	60	12,000	5.67
<b>F96T12CWHOCOLD*</b>	110	96	6,966	4,200K	60	12,000	5.74

\*For Cold Temperature Use

Lighting & Lighting Controls

**PULSE START METAL HALIDE**

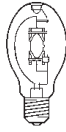

Vendor Code: SYL

Catalog Number	Watts	Base	Light Output Initial/Mean	Rated Life (h)	Price Each
<b>CLEAR BULB</b>					
<b>MS320PSBUH0RED28</b>	320	Mog.	32,000/21,000*	20,000	47.97

\*Light Output and Rated Life Based on Vertical Installation

**PULSE START METAL HALIDE FOR OPEN RATED FIXTURES**

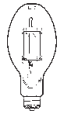

Vendor Code: SYL

Catalog Number	Watts	Base	Bulb Desc.	Light Output Initial/Mean	Rated Life (h)	Price Each
<b>MP100UMED</b>	100	Med.	Clear	7,600/4,900	15,000	37.21

\*Light Output and Rated Life Based on Base Up Installation  
Popular Lamps Indicated in Bold

**PROBE START METAL HALIDE**



Vendor Code: SYL

Catalog Number	Watts	Base	Bulb Desc.	Light Output Initial/Mean	Rated Life (h)	Price Each
<b>M175UMED</b>	175	Med.	Clear	*14,000/9,750*	10,000	27.98
<b>M250UED28</b>	250	Mog.	Clear	*21,500/17,500*	10,000	24.49
<b>M400UED37</b>	400	Mog.	Clear	*36,000/28,800*	20,000	32.71
<b>M400UED28</b>	400	Mog.	Clear	*36,000/23,500*	20,000	32.70
<b>M1000U</b>	1,000	Mog.	Clear	*110,000/88,000*	12,000	40.57
<b>M1000UBT37</b>	1,000	Mog.	Clear	110,000/93,500	15,000	45.97

\*Light Output and Rated Life Based on Base Up Installation  
Popular Lamps Indicated in Bold

**HIGH PRESSURE SODIUM**

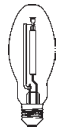

Vendor Code: SYL

Catalog Number	Watts	Base	Bulb Desc.	Light Output Initial/Mean	Rated Life (h)	Price Each
<b>LU250ECO</b>	250	Mog.	Clear	28,000/27,000	24,000+	24.67
<b>LU400ECO</b>	400	Mog.	Clear	51,000/45,000	24,000+	24.97

Popular Lamps Indicated in Bold

**DOUBLE BIAX 2 PIN**

WITH STARTER IN LAMP BASE FOR MAGNETIC BALLAST

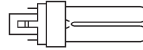

G24D-3

Vendor Code: SYL

Catalog Number	Watts	Length	Base	Lumens	Color	Rated Life (h)	Price Each
<b>CF26DD841ECO</b>	26	6.8"	G24D-3	1,548	4,100K	10,000	5.93

**U SHAPED FLUORESCENT LAMPS AND CIRCLINE**

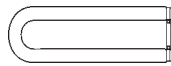

Vendor Code: SYL

Catalog Number	Watts	Length	Lumens	Color	CRI	Rated Life (h)	Price Each
<b>T8 - 6" SPACING</b>							
<b>FB0327416ECO</b>	32	22.5"	2,475	4,100K	75	20,000	13.80
<b>T12 - 6" SPACING</b>							
<b>FB40CWX6</b>	40	22.6"	1,806	4,100K	87	18,000	10.97

**DOUBLE BIAX 4 PIN FOR DIMMING AND ELECTRONIC BALLAST**



G24Q-2



G24Q-3

Vendor Code: SYL

Catalog Number	Watts	Length	Base	Lumens	Color	Rated Life (h)	Price Each
<b>CF18DDE835ECO</b>	18	5.8"	G24Q-2	989	3,500K	12,000	5.64
<b>CF26DDE835ECO</b>	26	6.5"	G24Q-3	1,470	3,500K	12,000	5.64

Popular Lamps Indicated in Bold

**TRIPLE BIAX 4 PIN FOR DIMMING AND ELECTRONIC BALLAST**



GX24Q-3



GX24Q-4

Vendor Code: SYL

Catalog Number	Watts	Length	Base	Lumens	Color	Rated Life (h)	Price Each
<b>CF32DTEIN835ECO</b>	32	5.6"	GX24Q-3	2,002	3,500K	16,000	7.48
<b>CF42DTEIN841ECO</b>	42	6.5"	GX24Q-4	2,670	4,100K	12,000	7.97

Popular Lamps Indicated in Bold

**T5 COMPACT FLUORESCENT LAMPS**

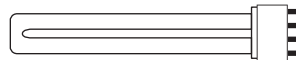

Vendor Code: SYL

Catalog Number	Watts	Length	Base	Lumens	Color	Rated Life (h)	Price Each
<b>FT40DLB41RSECO</b>	40	22.4"	2G11	2,709	4,100K	15,000	9.79





LED Lamps (Replacement Tubes · Sign Tubes · Tube Strip Fixtures)

LED REPLACEMENT TUBES  
DIRECT WIRE 120-277V

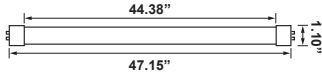

DirectDrive LED tubes eliminate the need for an external driver or ballast. For new construction installations, simply connect the 120-277V line voltage directly to the sockets. For retrofit installations, bypass the existing ballast by cutting the wires and connecting the 120-277V line voltage directly to the sockets. No ballast or driver is required.

- May be connected on one or each end.

Vendor Code: **KST**

Catalog Number	Watts	Color	Length	Lumens	Rated Life (h)	Price Each
<b>SHATTERPROOF COATED GLASS - SINGLE OR DOUBLE-ENDED WIRING</b>						
<b>L7T824GC840DX2</b>	7	4,000K	24"	950	50,000	9.70
<b>L15T848GC840DX2</b>	15	4,000K	48"	1,900	50,000	9.97
<b>PLASTIC - SINGLE ENDED WIRING</b>						
<b>LED36T896P850D**</b>	36	5,000K	96"	4,000	50,000	37.90

\*ETL Sanitation Listed NSF/ANSI Standard 2 - Food Equipment Catalog Numbers Listed are 4,000K (40). Replace 40 with 30 for 3,000K, 35 for 3,500K and 50 for 5,000K.  
\*\*Catalog Number Listed is 5,000K (50). Replace 50 with 40 for 4,000K.

BALLAST COMPATIBLE

- Compatible with Most Instant and Program Start Electronic T8 Ballasts, Check Ballast Compatibility List
- Direct Replacement for the Following Fluorescent Lamps: F32T8/32W, F32T8/30W, F32T8/28W, F32T8/25W

Vendor Code: **KST**

Catalog Number	Watts	Color	Length	Lumens	Rated Life (h)	Price Each
<b>SHATTERPROOF COATED GLASS</b>						
<b>LED15T848GC840S</b>	15	4,000K	48"	2,200	50,000	10.97

ETL Sanitation Listed NSF/ANSI Standard 2 - Food Equipment Catalog Numbers Listed are 4,000K (40). Replace 40 with 30 for 3,000K, 35 for 3,500K and 50 for 5,000K.

NON-SHUNTED TOMBSTONE HARNESSES

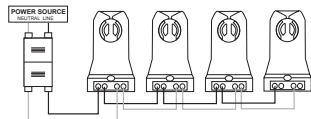

- Replacement for shunted sockets when using single ended direct wire tubes.

Vendor Code: **KST**

Catalog Number	Description	Price Each
<b>KT SOCKETT8UT2W*</b>	2-Lamp Wiring Harness for LED Tubes	5.09
<b>KT SOCKETT8UT4W**</b>	4-Lamp Wiring Harness for LED Tubes	7.05

\*Includes (2) Pre-Wired Tall, Non-Shunted Sockets with Power Quick Disconnect  
\*\*Includes (4) Pre-Wired Tall, Non-Shunted Sockets with Power Quick Disconnect



SIGN HERO LED SIGN TUBES

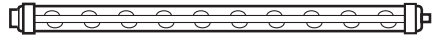

A perfect solution for retrofits or new sign installations, as well as single or double sided sign needs. With revolutionary DirectDrive technology there's no need for an external driver or ballast, saving precious labor time and costs.

Vendor Code: **KST**

Catalog Number	Watts	Color	Length	Lumens	Rated Life	Price Each
<b>360° DOUBLE SIDED TUBES</b>						
<b>LED21T848P2S865D</b>	21	6,500K	48"	2,600	50,000	48.25
<b>LED26T860P2S865D</b>	26	6,500K	60"	3,250	50,000	59.92
<b>LED31T872P2S865D</b>	31	6,500K	72"	4,000	50,000	71.58
<b>LED42T896P2S865D</b>	42	6,500K	96"	5,300	50,000	93.25
<b>LED52T8120P2S865</b>	52	6,500K	120"	6,400	50,000	133.25
<b>180° SINGLE SIDED TUBES</b>						
<b>LED11T848P1S865D</b>	11	6,500K	48"	1,340	50,000	37.87
<b>LED13T860P1S865D</b>	13	6,500K	60"	1,625	50,000	46.64
<b>LED16T872P1S865D</b>	16	6,500K	72"	2,000	50,000	54.97
<b>LED21T896P1S865D</b>	21	6,500K	96"	2,650	50,000	71.89
<b>LED26T8120P1S865</b>	26	6,500K	120"	3,200	50,000	98.97

Catalog numbers listed are 6,500K (65). Replace 65 with 40 for 4,000K. Also Available 18", 24", 30", 36", 42", 64", 84", 109", 117".

LED T5 HO TUBES



LED25.5T5H048GC8

L25T5H048GC850D

Vendor Code: **KST**

Catalog Number	Watts	Color	Length	Lumens	Rated Life (h)	Price Each
<b>BALLAST COMPATIBLE</b>						
<b>LED25.5T5H048GC8</b>	25.5	5,000K	48"	3,200	50,000	13.44
<b>120-277V</b>						
<b>L25T5H048GC850D</b>	25	5,000K	48"	3,400	50,000	14.14

ETL Sanitation Listed NSF/ANSI Standard 2 - Food Equipment Available in 3,500K, 4,000K, and 5,000K

LED TUBE STRIP FIXTURES

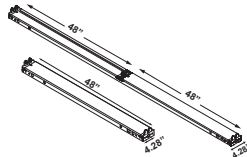

Vendor Code: **KST**

Catalog Number	Description	Price Each
<b>KTDDSLEDT842L</b>	4' 2-Lamp Configuration	24.99
<b>KTDDSLEDT884L</b>	8' 4-Lamp Configuration	39.99

For use with 120-277V LED Tubes (22W Max per Lamp) Lamps not Included

Lighting & Lighting Controls



LED HID Replacement Lamps · LED CFL Plug-In Replacement Lamps

LED HID REPLACEMENT LAMPS  
DIRECT WIRE 120-277V

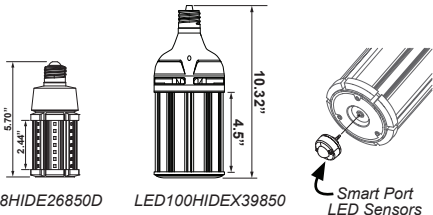

L18HIDE26850D

LED100HIDEX39850

Smart Port LED Sensors

- Smart Port LED sensors conveniently install in seconds via a standard 3.5mm AUX port connection. Simply insert the LED light sensor and adjust the settings quickly by hand. Even if you choose not to plug in a sensor, the light will operate as a regular lamp.

Vendor Code: **KST**

Catalog Number	Watts	Color	Typical Replacement	Lumens	Rated Life (h)	Price Each
<b>BASE TYPE: E26 (MEDIUM)</b>						
L18HIDE26850D	18	5,000K	70W	2,610	50,000	34.98
L27HIDE26850DG2	27	5,000K	100W	3,915	50,000	42.71
L36HIDE26850DG3*	36	5,000K	150W	5,400	50,000	49.45
L45HIDE26850DG3*	45	5,000K	175W	6,750	50,000	66.24
<b>BASE TYPE: EX39 (MOGUL)</b>						
L45HIDEX39850DG3*	45	5,000K	175W	6,750	50,000	66.24
L54HIDEX39850DG3*	54	5,000K	200/250W	8,100	50,000	63.41
L80HIDEX39850DG2*	80	5,000K	320W	12,000	50,000	114.69
L100HIDEX39850D2*	100	5,000K	400W	15,000	50,000	132.21

SMART PORT LED SENSORS

Catalog Number	Description	Price Each
KTSP1R112VAUX	PIR Motion Sensor	26.59
KTSPS112VAUX	Daylight Sensor	31.18
KTSMW112VAUX	Microwave Motion Sensor	30.69

\*Accepts SmartPort Sensors.  
Catalog Numbers for LED HID Replacement Lamps Listed are 5,000K (50). Replace 50 with 30 for 3,000K, and 40 for 4,000K.

**NEW**  
EXPANDABLE LED HID REPLACEMENT LAMPS  
EX39 ROTATABLE BASE  
DIRECT WIRE 120-277V

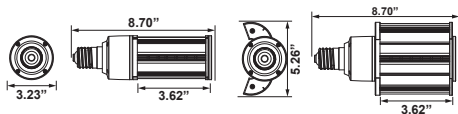

Vendor Code: **KST**

Catalog Number	Watts	Color	Typical Replacement	Lumens	Rated Life (h)	Price Each
L27HIDHEX39850D	27	5,000K	100/150W	4,100	50,000	58.38
L45HIDHEX39850D	45	5,000K	175W	6,400	50,000	69.15
L63HIDHEX39850D	63	5,000K	250W	9,200	50,000	120.33
L80HIDHEX39850D	80	5,000K	250/320W	10,000	50,000	145.96
L110HIDHEX39850D	110	5,000K	400W	14,000	50,000	159.84

Catalog Numbers Listed are 5,000K (50). Replace 50 with 30 for 3,000K, and 40 for 4,000K.

LED PLL REPLACEMENT  
DIRECT WIRE 120-277V

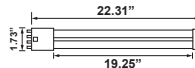

Vendor Code: **KST**

Catalog Number	Watts	Color	Length	Lumens	Base	Price Each
LED17PLL22G835D	17	3,500K	22"	2,200	2G11	14.21

Catalog Number Listed is 3,500K (35). Replace 35 with 40 for 4,000K or 50 for 5,000K.

VERTICAL LED HIGH BAY REPLACEMENT LAMPS  
DIRECT WIRE 120-277V

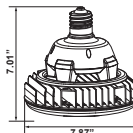

Vendor Code: **KST**

Catalog Number	Watts	Color	Typical Replacement	Lumens	Rated Life (h)	Price Each
L80HIDVEX39850D	80	5,000K	250W	9,600	50,000	153.77
L115HIDVEX39850D	115	5,000K	400W	15,700	50,000	164.33

Catalog Numbers Listed are 5,000K (50). Replace 50 with 30 for 3,000K and 40 for 4,000K.

LED CFL PLUG-IN REPLACEMENTS

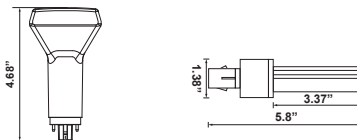

LED94PV840S

LED62PH840D

Vendor Code: **KST**

Catalog Number	Watts	Color	Base	Lumens	Orientation	Price Each
<b>BALLAST COMPATIBLE 4-PIN</b>						
LED94PV840S	9	4,000K	G24q	1,000	Vertical	10.99
LED94PH840S	9	4,000K	G24q	1,000	Horizontal	10.99
<b>DIRECT WIRE 120-277V 2-PIN</b>						
LED62PH840D	6	4,000K	GX23	700	Horizontal	9.99
LED82PV840D	8	4,000K	G24d	1,000	Vertical	8.99
LED82PH840D	8	4,000K	G24d	1,000	Horizontal	8.99
LED82PEV840D	8	4,000K	G24d	1,000	Extended Vertical	8.99

Catalog Numbers Listed are 4,000K (40). Replace 40 with 27 for 2,700K, 30 for 3,000K, 35 for 3,500K and 50 for 5,000K.







## LED Lamps (A-Line · Reflector · PAR · MR16 · Decorative)

### LED A-LINE LAMPS



Vendor Code: **KST**

Catalog Number	Watts	Color	Lumens	CRI	Price Each
<b>DIMMABLE</b>					
<b>LED6A190930</b>	6	3,000k	450	90	2.16
<b>LED9A190930</b>	9	3,000k	800	90	2.97
<b>LED11A190830</b>	11	3,000k	1,100	80	3.08
<b>NON-DIMMABLE</b>					
<b>LED6A190830ND</b>	6	3,000k	480	80	1.38
<b>LED9A190830ND</b>	9	3,000k	800	80	1.49
<b>LUMEN ADJUSTABLE</b>					
<b>LED16A2108303W</b>	6/8/16	3,000k	450/800/1,600	80	7.69

Catalog Numbers Listed are 3,000k (30). Replace 30 with 27 for 2,700k or 50 for 5,000k.

### LED REFLECTOR LAMPS

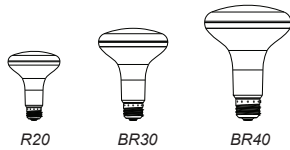

Vendor Code: **KST**

Catalog Number	Watts	Color	Lumens	CRI	Price Each
<b>R20</b>					
<b>LED7R20930</b>	7	3,000k	525	90	4.61
<b>BR30</b>					
<b>LED8BR30930</b>	8	3,000k	700	90	4.99
<b>BR40</b>					
<b>LED15BR40930</b>	15	3,000k	1,200	90	8.21

Catalog Numbers Listed are 3,000k (30). Replace 30 with 27 for 2,700k or 50 for 5,000k.

### LED PAR LAMPS



Vendor Code: **KST**

Catalog Number	Watts	Color	Lumens	CRI	Price Each
<b>PAR20</b>					
<b>LED6PAR20F930</b>	6	3,000k	500	90	5.69
<b>PAR30</b>					
<b>LED9.5PAR30F930</b>	9.5	3,000k	800	90	7.69
<b>PAR38</b>					
<b>LED13PAR38F830*</b>	13	3,000k	1,200	80	7.69
<b>LED13PAR38NF830**</b>	13	3,000k	1,250	80	7.69

Catalog Numbers Listed are 3,000k (30). Replace 30 with 27 for 2,700k, 40 for 4,000k or 50 for 5,000k.  
\*40° Beam Angle  
\*\*25° Beam Angle

### LED MR16 LAMPS

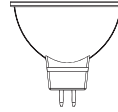

Vendor Code: **KST**

Catalog Number	Watts	Color	Lumens	Beam Angle	Price Each
<b>LED6MR16S830</b>	6	3,000k	450	35°	3.69
<b>LED7.5MR16NS930</b>	7.5	3,000k	570	25°	7.09
<b>LED7.5MR16S930</b>	7.5	3,000k	570	35°	7.09

Catalog Numbers Listed are 3,000k (30). Replace 30 with 27 for 2,700k, 40 for 4,000k or 50 for 5,000k.

### LED DECORATIVE LAMPS

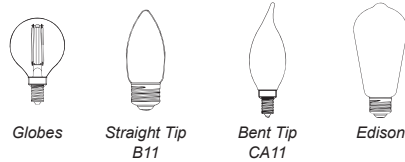

Vendor Code: **KST**

Catalog Number	Watts	Color	Lumens	Base	Price Each
<b>GLOBES</b>					
<b>LED45FG16E12930C</b>	4.5	3,000k	350	Candlabra	2.92
<b>LED55FG25E26930C</b>	5.5	3,000k	500	Medium	3.75
<b>STRAIGHT TIP B11</b>					
<b>LED4FB11E26927C</b>	4	2,700k	350	Medium	2.69
<b>BENT TIP CA11</b>					
<b>L5.5FCA11E12927C</b>	5.5	2,700k	500	Candlabra	2.99
<b>EDISON</b>					
<b>L4.5FST19E26822A</b>	4.5	2,200k	350	Medium	3.79

Lighting & Lighting Controls



LED Tape Lights · LED Tape Drivers · Channel Covers · Channel End Caps

BLAZE™ 12V LED TAPE LIGHT

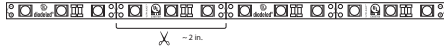

BLAZE Tape Light is a versatile, indirect, linear light that provides high-output, architectural-grade lighting at 80+ CRI. BLAZE is available in a wide range of color temperatures, from warm whites starting at 2,400K, to very cool white 6,300K, as well as red, green, and blue. BLAZE's high lumen output makes it ideal for task and display lighting, as well as an efficient ambient light when paired with an LED dimmer.

Vendor Code: **DIO**

Catalog Number	Watts per foot	Kelvin	Length	Lumens per foot	Price Each
<b>DI12VBL308016</b>	2.88	3,000K	16.4' Spool	286	243.08
<b>DI12VBL278016</b>	2.88	2,700K	16.4' Spool	293	243.08
<b>DI12VBL3080100</b>	2.88	2,700K	100' Spool	286	1159.23
<b>DI12VBL2780100</b>	2.88	3,000K	100' Spool	293	1159.23

Replace the Two Black Numbers with **24** for 2,400K, **27** for 2,700K, **30** for 3,000K, **33** for 3,300K, **35** for 3,500K, **38** for 3,800K, **42** for 4,200K, **44** for 4,400K, **50** for 5,000K, and **63** for 6,300K.

LED TAPE DRIVERS

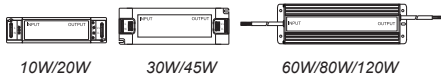

OMNIDRIVE® Electronic Dimmable Drivers are our best-selling dimmable power supplies. They offer superior dimming performance for the widest range of dimming switches. The built-in electronic filter eliminates flicker and provides the smoothest dimming from 100% down to 10%. They offer superior dimming performance when paired with: TRIAC dimmer controls, magnetic low voltage (MLV), electronic low voltage (ELV) and incandescent/halogen dimmer switches, as well as 3/4/5-way and on/off switching.

Vendor Code: **DIO**

Catalog Number	Watts	Voltage	Dimensions	Price Each
<b>ENVIRONMENT RATING: INDOOR</b>				
<b>DITD12V20W</b>	20	12V DC	5.5 x 1.8 x 1.1 in.	70.77
<b>DITD12V30W</b>	30	12V DC	7 x 2.3 x 1.4 in.	81.54
<b>DITD12V45W</b>	45	12V DC	7 x 2.3 x 1.4 in.	90.00
<b>ENVIRONMENT RATING: OUTDOOR/INDOOR</b>				
<b>DITD12V60W</b>	60	12V DC	7.9 x 2.7 x 1.8 in.	104.62
<b>DITD12V80W</b>	80	12V DC	7.9 x 2.7 x 1.8 in.	118.46
<b>DITD12V120W</b>	120	12V DC	7.9 x 2.7 x 1.8 in.	145.38



CHROMAPATH® BUILDER CHANNELS FOR LED TAPE

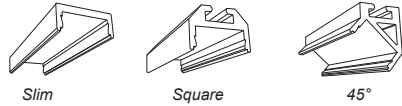

Vendor Code: **DIO**

Catalog Number	Form Factor	Length	Finish	Included Accessories	Price Each
<b>DICPCHASL48</b>	Slim	48"	Aluminum	No	17.26
<b>DICPCHASQ48</b>	Square	48"	Aluminum	Yes*	26.73
<b>DICPCHA4548</b>	45°	48"	Aluminum	Yes*	33.67

\*Includes Four Mounting Clips with Screws and Two End-to-End Interconnects.

CHANNEL COVERS

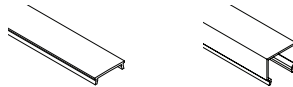

Vendor Code: **DIO**

Catalog Number	Form Factor	Length	Price Each
<b>DICPCHCFR48</b>	Frosted Cover	48"	6.97
<b>DICPCHCPD48</b>	Premium Diffusion	48"	11.78

CHANNEL END CAPS

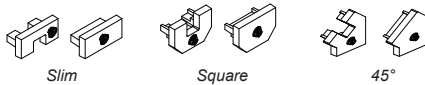

Vendor Code: **DIO**

Catalog Number	Description	Price Each
<b>DICPECSL</b>	Gray Slim End Caps	8.88
<b>DICPECSQ</b>	Gray Square Endcaps	8.88
<b>DICPEC45</b>	Gray 45° End Caps	13.85

A Set of End Caps Includes Closed and Notched Open Cap That Can Accommodate Wire up to 18 AWG. Catalog Numbers Listed Above are Gray. Add **W** to the End of the Part Number for White or **B** to the End of the Part Number for Black.

CLICKTIGHT® PRO TAPE LIGHT CONNECTORS

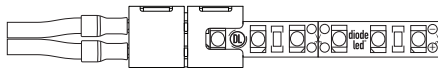

Vendor Code: **DIO**

Catalog Number	Type	Dimensions	Price Each
<b>DICKTPTTW10*</b>	Tape to Wire Connector	0.51 x 1.1 in.	48.47
<b>DICKTPTTT5**</b>	Tape to Tape Connector	0.51 x 1.1 in.	25.78

\*Includes 10 Connectors, 25 Spade Connectors and 10 Wire Fasteners w/ 10 Nails  
\*\*Includes 5 Connectors, 10 Tape Light Fasteners and 20 Screws



Lighting & Lighting Controls



## FLUORESCENT BALLASTS

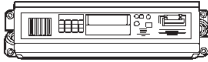

### ELECTRONIC BALLAST

Vendor Code: **ADV**

Catalog Number	Number of Lamps and Type	Price Each
<b>120-277V</b>		
<b>ICN2P32N35I</b>	1 or 2: F17T8, F25T8, F32T8, F40T8	20.99
<b>ICN3P32N35I</b>	2 or 3: F17T8, F25T8, F32T8, F40T8	23.40
<b>ICN4P32N35I</b>	3 or 4: F17T8, F25T8, F32T8	25.82
<b>ICN2S40N35I</b>	2: F34T12, F34T12U	20.99
<b>ICN2P60N35I</b>	1 or 2: F72T12, F96T12	29.97
<b>ICN2S110SC35I</b>	2: F48T12H0, F60T12H0	43.99

Popular Ballasts Indicated in Bold.

### ELECTRONIC HIGH BAY BALLAST RATED AT 90C FOR HIGH TEMP APPLICATIONS

Vendor Code: **ADV**

Catalog Number	Number of Lamps and Type	Price Each
<b>120-277V</b>		
<b>ICN2S5490CT35M</b>	2: F54T5H0	58.77
<b>ICN4S5490C2L35G3</b>	4: F54T5H0	79.99

Blank Start For Frequent Switching Applications Such as Occupancy Sensors, Programmed Start Ballasts Are Recommended and Require Non-Shorted Lamp Sockets.

### ELECTRONIC BALLAST KIT FOR 4-PIN COMPACT FLUORESCENT LAMPS T4, 2D, T5 AND TT5

Vendor Code: **ADV**

Catalog Number	Number of Lamps and Type	Price Each
<b>120-277V</b>		
<b>ICF2S26H1LDK</b>	1 or 2: 26W CFL; 1: 28W CFL, 32W CFL, 42W CFL	36.19
<b>ICF2S42M2LDK</b>	2: 26W CFL, 28W CFL, 40W CFL, 42W CFL	37.99

### SIGN

### 120V / 800MA, HO RAPID START

Vendor Code: **ADV**

Catalog Number	Number of Lamps	Min. - Max. Lamp Length	Price Each
<b>ISB021612EI</b>	1 - 2	2 - 16"	56.99
<b>ISB104014EI</b>	1 - 2	10 - 40"	129.99
<b>ISB043214EI</b>	1 - 4	4 - 32"	107.99
<b>ISB084846EI</b>	4 - 6	8 - 48"	136.99

## HIGH INTENSITY DISCHARGE REPLACEMENT BALLASTS

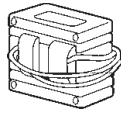

### HIGH PRESSURE SODIUM BALLAST

Vendor Code: **ADV**

Catalog Number	Lamp Watts	Lamp Type	Price Each
<b>MULTI-TAP: 120/208/240/277V</b>			
<b>71A8172001D</b>	150	S-55	117.68
<b>5-TAP: 120/208/240/277/480V</b>			
<b>71A8453001D</b>	400	S-51	169.39

Includes Core & Coil, Capacitor and Ignitor Where Required.

Popular Ballasts Indicated in Bold.

## METAL HALIDE BALLAST

Vendor Code: **ADV**

Catalog Number	Lamp Watts	Lamp Type	Price Each
<b>MULTI-TAP: 120/208/240/277V</b>			
<b>71A5390001D</b>	100	M90 / M140	113.82
<b>71A5570001D</b>	175	M57 / H39	107.51
<b>5-TAP: 120/208/240/277/480V</b>			
<b>71A5750001D</b>	250	M58 / H37	106.24
<b>71A6051001D</b>	400	M59 / H33	126.49
<b>71A6552001</b>	1,000	M47 / H36	189.75
<b>SINGLE TAP: 480V</b>			
<b>71A6742001</b>	1,500	M48	265.65
<b>MULTI-TAP: 120/208/240/277V</b>			
<b>71A6772001</b>	1,500	M48	265.62

Includes Core & Coil and Capacitor. Popular Ballasts Indicated in Bold.

### PULSE START METAL HALIDE BALLAST

Vendor Code: **ADV**

Catalog Number	Lamp Watts	Lamp Type	Price Each
<b>71A5792001D</b>	250	M138 / M153	124.29
<b>71A6092001D</b>	400	M135 / M155	126.49

120/208/240/277V Must Use Pulse Start Lamps.

## PROGRAMMABLE LED DRIVERS

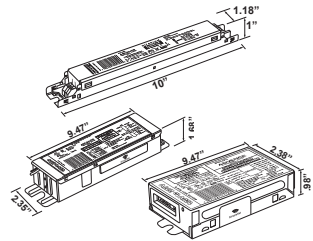

Vendor Code: **ADV**

Catalog Number	Output Current	Output Voltage	Price Each
<b>LAY-IN/INTEGRATED DRIVERS</b>			
<b>XI020C056V054BST</b>	100-560	22.5-54	35.45
<b>XI054C150V054BST</b>	100-1,500	22.5-54	42.52
<b>XI075C200V054BST</b>	100-2,000	27-54	47.51
<b>OUTDOOR AND INDUSTRIAL DRIVERS</b>			
<b>XI055C180V054BSJ</b>	100-1,800	18-54	52.59
<b>XI095C275V054BSF</b>	100-2,750	20-54	64.97
<b>XI180C125V200BSF</b>	100-1,250	70-210	69.97
<b>COMMERCIAL DOWNLIGHTING DRIVERS</b>			
<b>XI036C100V054DSM</b>	100-1,000	27-54	50.02

\*Bolted Numbers Indicates Maximum Output Wattage

## DESKTOP READER FOR PROGRAMMABLE DRIVERS

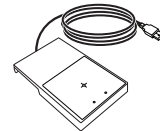

By using the desktop programming tool, trained associates are capable of quickly programming LED drivers equipped with SimpleSet technology. Ask your local sales representative about in store programming capabilities in your area.

Vendor Code: **ADV**

Catalog Number	Description	Price Each
<b>LCN9620</b>	LED Driver Programming Tool	400.00



Try QuickSelect Now!  
Desktop Reader for Programmable Drivers

**ADVANCE**

by Signify

Lighting & Lighting Controls



LED HID REPLACEMENTS



These LED corn lamps feature five extendable panels, capable of adjusting to three different light distribution options (360° beam angle, 270° beam angle, and a 180° beam angle)! These lamps are UL listed for damp locations and approved for use in totally enclosed fixtures.

Vendor Code: **SAT**

Catalog Number	Watts	Color	HID Equivalent	Lumens	Life	Price Each
<b>S29751</b>	40	5,000K	175W	5,200	50,000	77.08
<b>S29752</b>	60	5,000K	250W	7,800	50,000	92.67

These Lamps are Not for Use with Dimmers. Surge Protector Sold Separately.

SHOE BOX LAMP SERIES

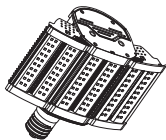

These LED lamps a convenient and energy-efficient solution for replacing traditional high-pressure sodium and metal halide sources in enclosed shoe box parking lot area lighting fixtures.

Vendor Code: **SAT**

Catalog Number	Watts	Color	HID Equivalent	Lumens	Life	Price Each
<b>S8932</b>	80	5,000K	250W	10,000	50,000	162.59
<b>S8938</b>	110	5,000K	400W	14,000	50,000	178.78

LED FILAMENT LAMPS



S9876



S9923



S9255



S9872

If you are looking for the antique style and traditional incandescent look and feel with all the energy efficient benefits LED technology can provide, this is the bulb for you. The Satco LED Filament Lamps are the perfect vintage light bulb with an historically accurate and beautifully reproduced design.

Vendor Code: **SAT**

Catalog Number	Watts	Lumens	Color	Bulb	Base	Price Each
<b>S29879</b>	8	800	2,700K	A19	Medium	6.26
<b>S29923</b>	4	350	2,700K	CA11	Candelabra	4.25
<b>S8613</b>	3.5	350	2,700K	C11	Candelabra	9.99
<b>S9569</b>	4.5	450	2,700K	C11	Medium	4.54
<b>S9564</b>	6.5	810	2,700K	G25	Medium	5.94
<b>S9872</b>	2.5	200	2,700K	T6	Candelabra	4.23

LED PAR LAMPS



Vendor Code: **SAT**

Catalog Number	Lamp Type	Watts	Lumens	Color	Beam Spread	Price Each
<b>S9405</b>	PAR20	7	525	2,700K	40°	4.54
<b>S9436</b>	PAR30	13	1,000	3,000K	60°	7.52
<b>S9454</b>	PAR38	15	1,200	5,000K	60°	10.59

LED REFLECTOR LAMPS

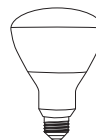

Vendor Code: **SAT**

Catalog Number	Lamp Type	Watts	Lumens	Color	CRI	Rated Life	Price Each
<b>S9631</b>	BR20	6.5	525	3,000K	80	25,000	6.67
<b>S9621</b>	BR30	9.5	750	3,000K	80	25,000	7.46
<b>S9635</b>	BR40	11.5	940	3,000K	80	25,000	7.13

LED MINIATURE LAMPS



S9542

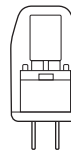

S9544

These lamps are silicon LED replacements for Halogen G4, G6.35, G9, GU5.3, MR11 and MR16 lamps. The light of these lamps is thrust upward. They are dimmable and have a 25,000 hour life. There is a silicon based sealant on the outer shell, so these lamps can be used in wet or damp applications like outdoor lighting!

Vendor Code: **SAT**

Catalog Number	Watts	Lumens	Color	Volts	Base	Price Each
<b>S9542</b>	1.6	200	3,000K	12	G4	8.59
<b>S9544</b>	3	300	3,000K	12	G6.35	9.99





## 120V DIMMERS



Ariadni



Skylark Contour



Diva



Maestro

- C.L. dimmers are forward phase dimmers specifically designed for controlling dimmable LEDs, incandescent, and halogen bulbs.
- Alleviate dimmer interaction for smooth, flicker-free dimming
- No neutral required.
- All are 600W for incandescent or halogen lamps.

Vendor Code: **LUT**

Catalog Number	LED/ CFL	Type	Price Each
<b>ARIADNI</b>			
AYCL153PWH	150	Single Pole/3 Way	26.02
AYCL253PWH	250	Single Pole/3 Way	41.84
<b>SKYLARK CONTOUR</b>			
CTCL153PWH	150	Single Pole/3 Way	28.97
CTCL150HWH	150	Single Pole Only	26.97
<b>DIVA</b>			
DVCL153PWH	150	Single Pole/3 Way	29.19
DVCL253PWH	250	Single Pole/3 Way	67.90
<b>MAESTRO</b>			
MACL153MWH	150	Multi-Location	35.33
MARWH	Companion Dimmer for Multi-Location Application.		23.12

## REVERSE PHASE DIMMERS



Diva



Skylark Contour



Nova T

- Reverse phase dimmers control dimmable LEDs and CFLs, as well as incandescent, halogen, and ELV loads.
- All are 500W for incandescent, halogen lamps, or ELV lamps.

Vendor Code: **LUT**

Catalog Number	LED/ CFL	Type	Price Each
<b>DIVA</b>			
DVPR253PWH	250	Single Pole/3-Way	93.76
<b>SKYLARK CONTOUR</b>			
CTRP253PWH	250	Single Pole/3-Way	59.97
<b>NOVA T</b>			
NTRP250WH	150	Single Pole	117.56

## NEW MAESTRO C.L. PRO DIMMER



### MAPROWH

- Phase selectable – works in both forward or reverse phase dimming.
- Neutral optional.
- Load ratings: 250W of LED/CFL, 500W of Incandescent/Halogen/ELV, 400VA/300W of MLV

### MKDWH

- Color Change Kits allow for changing the color of the actuating switch assembly of an existing MA-PRO dimmer.

Vendor Code: **LUT**

Catalog Number	Description	Price Each
MAPROWH	120V, Phase Selectable Neutral Optional Dimmer	58.95
<b>COLOR CHANGE KITS</b>		
MKDWH	1 Piece Color Change Kit	7.46
MKD5WH	5 Piece Color Change Kit	22.38

Catalog Numbers Listed Above are White (WH). Replace WH with LA for Light Almond, or BL for Black.

## 0-10V DIMMERS

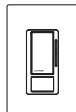

MSZ101WH

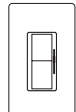

DVSTVWH

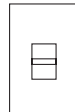

NTSTVDVWH

Lutron Maestro 0-10 V Dimmer Sensors are lighting controls with passive infrared sensors that automatically control the lights in an area. These sensors detect heat from occupants moving within an area to determine when the space is occupied. The Maestro 0-10 V Dimmer Sensor combines a Maestro 0-10 V Dimmer with an occupancy or vacancy Sensor.

Vendor Code: **LUT**

Catalog Number	Type	Price Each
<b>120-277 OPERATING VOLTAGE</b>		
MSZ101WH	Single Pole/Multi-Location	89.97
DVSTVWH	Single Pole/3 Way	83.99
NTSTVDVWH	Single Pole	104.96



## FAN CONTROLS

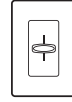

Skylark



Ariadni



Diva

Vendor Code: **LUT**

Catalog Number	Amp	Type	Price Each
<b>SKYLARK (SLIDE TO ON/OFF)</b>			
SFSQFHW	1.5	3 Speed	21.79
SFSSEWH	5	Variable	36.59
<b>ARIADNI (TOGGLE SWITCH)*</b>			
AYFSQFHW	1.5	3 Speed	25.09
<b>DIVA (DECORATOR SWITCH)*</b>			
DVFSQFHW	1.5	3 Speed	34.57
<b>SKYLARK CONTOUR FAN CONTROL</b>			
CTFSQFHW	1.5	3 Speed	22.85

\*For Single Ceiling Fan.

## FAN & LIGHT CONTROLS

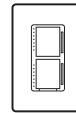

Maestro



Diva

- UL Listed to control: LED, CFL, Incandescent, Halogen loads.
- No canopy module required
- No neutral wire required

Vendor Code: **LUT**

Catalog Number	Light Rating	Price Each
<b>MAESTRO</b>		
MACLLFQWH	250W Inc./Halogen or 75W LED/CFL	61.18
<b>DIVA</b>		
DVFSQLFWH	1A LED/CFL (switch only)	33.59

## DUAL SLIDE



Skylark



Ariadni

- All are 300W for incandescent lamps.

Vendor Code: **LUT**

Catalog Number	Amp	Type	Price Each
<b>SKYLARK</b>			
S2LFSQWH	1.5	3 Speed	33.38
S2LFWH	2.5	Variable	39.97
<b>ARIADNI</b>			
AY2LFSQWH	1.5	3 Speed	33.38

1.5A for 1 Fan Only  
2.5 Amp for Multiple Fans

Lighting & Lighting Controls



Wireless Sensor Products

**SENSORS**  
OCCUPANCY/VACANCY

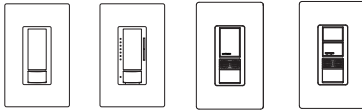

- Programmable Occupancy (Automatic ON/Automatic OFF) or Vacancy (Manual ON/Automatic OFF).
- Tamper-resistant lenses.
- Ambient light detection (set to learnable or fixed).
- Adjustable timeout settings.
- No Dip switches or dials.

Vendor Code: **LUT**

Catalog Number	Description	Type	Price Each
<b>SINGLE CIRCUIT PIR</b>			
<b>MS0PS2WH</b>	120V, 2A	Single Pole	21.49
<b>MS0PS5MWH</b>	120V, 5A Lighting, 3A (120V) Fan	3-Way/Multi-Location	37.55
<b>MS0PS6M2UDVWH</b>	120/277V 6A Lighting, 3A Fan Neutral Required	3-Way/Multi-Location	42.96
<b>MS0PS6M2DVWH</b>	120/277V 6A Lighting, 3A Fan No Neutral	3-Way/Multi-Location	38.99
<b>DUAL CIRCUIT PIR</b>			
<b>MS0PS6DDVWH</b>	120/277V, 6A Lighting, 4.4A (120V) Fan Per Circuit	Single Pole	65.27
<b>C.L. DIMMER SENSOR</b>			
<b>MSCL0P153MWH</b>	120V, 600W Inc, 150W CFL/LED	3-Way/Multi-Location	43.97
<b>0-10V DIMMER SENSOR</b>			
<b>MSZ101WH</b>	120/277V, 8A Lighting, Neutral Optional	3-Way/Multi-Location	89.97
<b>SINGLE CIRCUIT, DUAL TECH</b>			
<b>MSA102WH</b>	120/277V, 6A Lighting, 4.4A (120V) Per Circuit, No Neutral	Single Pole	79.59
<b>MSB102WH</b>	120/277V, 6A Lighting, 4.4A (120V) Per Circuit, Neutral Required	3-Way/Multi-Location	79.59
<b>DUAL CIRCUIT, DUAL TECH</b>			
<b>MSA202WH</b>	120/277V, 6A Lighting, 4.4A (120V) Per Circuit, No Neutral	Single Pole	93.56
<b>MSB202WH</b>	120/277V, 6A Lighting, 4.4A (120V) Per Circuit, Neutral Required	3-Way/Multi-Location	93.56



**NEW**

**VIVE HUBS**



Vive Hub



Power Supply



Flush-Mount Adapter

- Communicates with controls on a floor using Lutron wireless Clear Connect technology (range radius of 71 ft).
- Distributed system architecture.
- Wireless sensors and controls must be located within 60 ft. line of sight, or 30 ft., through walls, of the associated device.
- Supports timeclock events based on both sunrise and sunset or fixed time-of-day.
- Integrated multi-color LED provides feedback on what mode the hub is in.
- Contact Closure Inputs for integration with devices by others including devices for Title 24 Automatic Demand Response.

Vendor Code: **LUT**

Catalog Number	Description	Price Each
<b>HJS0FM</b>	Starter Hub, Flush-Mount Adapter and Power Supply	Contact
<b>HJS1FM</b>	Vive Hub, Flush-Mount Adapter and Power Supply	Elliott
<b>HJS1SM</b>	Vive Hub, Surface-Mount Adapter and Power Supply	Electric
<b>HJS2FM</b>	Premium Vive Hub, Flush-Mount Adapter and Power Supply	Supply
<b>HJS2SM</b>	Premium Vive Hub, Surface-Mount Adapter and Power Supply	Sales Rep

See the Chart for Summary of Code Requirements for Lighting Control on Page L23.

**RADIO POWR SAVR™ WIRELESS SENSORS**

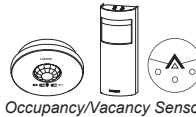

Occupancy/Vacancy Sensor



Daylight Sensor

Vendor Code: **LUT**

Catalog Number	Description	Price Each
<b>OCCUPANCY/VACANCY SENSORS</b>		
<b>LRF20CR2BPWH</b>	Ceiling Mount, 360° Field-of-View	70.47
<b>LRF20WLBPWH</b>	Wall Mount, 180° Field-of-View	70.47
<b>LRF20KLBPWH</b>	Corner Mount, 90° Field-of-View	70.47
<b>LRF20HLBPWH</b>	Hallway	70.47
<b>DAYLIGHT SENSOR</b>		
<b>LRF2DCRBWH</b>	Ceiling Mounted	92.56

**NEW**

**RF RECEPTACLES**

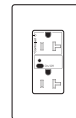

Vendor Code: **LUT**

Catalog Number	Description	Price Each
<b>WIRELESS</b>		
<b>CAR2S15STRWH</b>	15A Split (Half Switching, Single Pole/Downstream), 120V	139.28
<b>CAR2S15DTRWH</b>	15A Duplex (Dual Switching, Single Pole/Downstream), 120V	139.28
<b>CAR2S20STRWH</b>	20A Split (Half Switching, Single Pole/Downstream), 120V	155.37
<b>CAR2S20DTRWH</b>	20A Split (Half Switching, Single Pole/Downstream), 120V	155.37



### MAESTRO® WIRELESS PRODUCTS

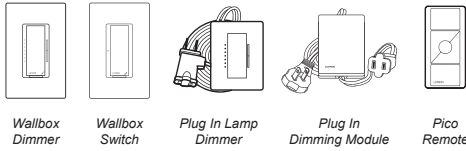

Vendor Code: LUT

Catalog Number	Description	Price Each
<b>WALLBOX DIMMERS, SINGLE POLE/MULTI-LOCATION</b>		
MRF2600MWH	120V, 600W Incandescent/Halogen	74.46
MRF26MLVWH	120V, 600W Incandescent/Halogen, Magnetic Low Voltage	82.48
<b>WALLBOX SWITCHES</b>		
MRF26ANSWH	120V, 6 A Light or 3A Fan, Incandescent, Halogen, MLV, ELV, Non-Dim Fluorescent Ballasts, and General Purpose Fans	82.11
MRF28SDVWH	120V / 8A Light or 3A Fan or 1/10 HP Motor	115.38
<b>PLUG IN LAMP DIMMER</b>		
MRF23LDWH	300 W, Inc./Halogen for Table or Floor Lamps	109.87
<b>PLUG IN DIMMING MODULE</b>		
MRF23PD1WH	120V, 300W Incandescent/Halogen Plug-In Dimming/Switching Module, One Receptacle	84.34
<b>PICO REMOTE</b>		
PJ3BRLGWHT01	Pico Wireless Controller, Light Text	19.97

Replace WH with IV for Ivory, AL for Almond, LA for Light Almond or BL for Black.

### POWPAK® CONTROLS



Vendor Code: LUT

Catalog Number	Description	Price Each
<b>POWPAK RELAY MODULE</b>		
RMJS5RDVB	5A Relay	96.67
RMJS5RCC01DVB	5A Relay with One Contact Closure Output	101.37
RMJS16RDVB	16A Relay	105.38
RMJS16RCC01DVB	16A Relay with One Contact Closure Output	118.62
<b>UL 924 RATED EMERGENCY WIRELESS CONTROLS</b>		
RMJS16RDVBEM	Emergency Rated 16A Relay	146.38
RMJS8TDVBEM	Emergency Rated 8A, 0-10V Dimmer	163.29
FCJSECOEM	Emergency Rated Ecosystem Control Module	97.84
FCJS010EM	Emergency Rated 0-10V Control Module	98.97
<b>POWPAK DIMMING MODULE</b>		
RMJS8TDVB	8A 0-10V Controller-Connector	132.38
RMJS8TNDVB	8A 0-10V Controller-Flying Leads	132.38
RMJSEC032SZ	Single Zone Ecosystem/DALI Controller	132.38
<b>POWPAK CONTACT CLOSURE OUTPUT MODULE</b>		
RMJSCC0124B	One Contact Closure Output	89.59

### SERENA® REMOTE CONTROLLED SHADES

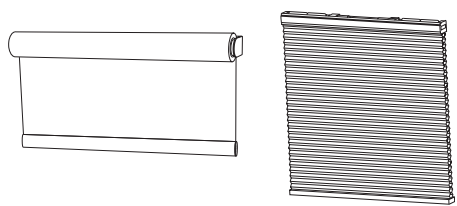

Roller Style

Honeycomb Style

Serena automated shades are smart shades at an affordable price. Serena automated shades let you schedule your window shades to automatically raise at a set time every morning. You can close as well as open your shades with the press of a button.

- Shades install and operate without wires. You can mount them inside or outside the window frame.
- Shades feature industry-leading battery performance, and you can replace the batteries without taking down the shade.
- The cordless design provides a safer solution for homes with children or pets.
- Available in roller or insulating honeycomb styles, with a variety of headrail options.
- Choose from a wide selection of fabric colors and textures, as well as three opacities.
- Use the Smart Bridge and free Lutron App for convenient control from anywhere. You can also integrate shade control with other smart home solutions, including Amazon Alexa, Apple® HomeKIT™, Google® Assistant, and more!

Starting at **\$350.00** for a 3' x 5' window, automated shades are more affordable than ever. Contact your local Elliott Electric Supply for more information

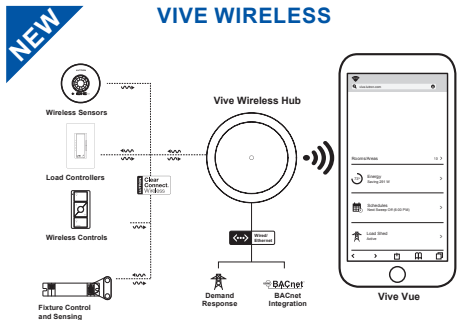

Vive wireless is a revolutionary, modular wireless lighting control system for new and existing commercial buildings.



Lighting & Lighting Controls

RA2 Select Products · Caseta Wireless Products



RA2 SELECT PRODUCTS



C·L Dimmer

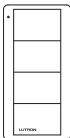

Pico

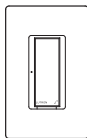

Switch

When you choose RA2 Select, you're selecting a smart home system comprised of keypads, light controls, fan controls, temperature controls, appliance controls, and shades. RA2 Select was developed so you can choose the specific components you want in order to create the system that will best suit your lifestyle.

Vendor Code: LUT

Catalog Number	Description	Price Each
<b>C·L DIMMER</b>		
MSB102WH	120 V/ 600 W/ 150 W LED	79.59
<b>PICO WIRELESS CONTROL</b>		
PJ23BRLWHL01R	434 MHz, 4-button	17.49
<b>SWITCH WITH NEUTRAL WIRE</b>		
RRD8ANSWH*	120 V/ 8 A	129.74

\*Replace WH with BL for Black, IV for Ivory, or LA for Light Almond.

ADDITIONAL SMART HOME TECHNOLOGY

- Apple® HomeKit™**  
The Smart Bridge contains Apple HomeKit technology, so you can use Siri® to control your lights and shades.
- nest**  
Nest Protect smoke + CO alarm  
When smoke or CO is detected your lights will turn on and your shades will open automatically to help you find your way
- IFTTT (If This Then That)**  
Create IFTTT recipes, such as lowering your shades if it's sunny, or turning off lights if the Nest thermostat is set to "Away" mode
- Logitech Harmony**  
Dim lights, lower shades, and start a movie with one button press on Logitech Harmony hub-based remote controls or from the Harmony app.
- works with XFINITY Home**  
Control your lights from anywhere using the XFINITY Home app.
- amazon alexa**  
Amazon Alexa  
Create just the right light using Alexa voice control. Ask Alexa to turn lights on, off, or dim them to your favorite level.
- SONOS**  
Control your Sonos Home Sound System from a Pico remote control for audio or from scenes in the Lutron App.
- works with the Google Assistant**  
Get the lights with just your voice. Smart lighting control is now available through any Google Assistant-enabled device.



CASÉTA™ WIRELESS PRODUCTS

Adjusting lights and shades from a smart phone has never been easier, more reliable, or affordable. The Smart Bridge Pro works with Caséta™ Wireless dimmers and is compatible with Serena®, Triathlon®, and select styles of Sivoia® QS Wireless shades. Control lights and shades from anywhere so lights aren't left on or shades aren't left open while you're away. Schedule lights and shades to automatically adjust via the timed clock at set times of day. Integrate light and shade control with select security systems and A/V remote controls

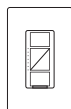

Dimmer

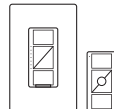

Kits with Dimmer, Pico Remote and Wallplate



Smart Bridge Kit



Pico Remote



Single Tabletop Pedestal

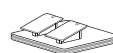

Double Tabletop Pedestal

Caséta Wireless provides peace of mind, comfort and convenience at the touch of a button. So whether you want your lights on, off, or somewhere in between, you can count on Caséta Wireless to deliver what you need.

Control your lights from anywhere

- Turn lights on from your car, purse, or pocket
- Dim lights for a movie
- Turn off lights from your bedside

Add comfort and enhance peace of mind

- Adjust lights for any activity
- Create just the right ambiance
- Turn lights on before you walk into your house

Install in minutes

- Ideal for existing or new homes
- No new wiring required
- Set up is easy

Vendor Code: LUT

Catalog Number	Description	Price Each
<b>KITS</b>		
PPKG1WWH	1 In-Wall Light Dimmer, 1 Pico Remote, 1 Wallplate	63.11
PJ2WALLWHL01	1 Pico Remote, 1 Wallplate Bracket, 1 Wallplate	29.63
PBDGPKG1W	1 Smart Bridge, 1 In-Wall Light Dimmer, 1 Pico Remote, 1 Wallplate	107.76
<b>SMART BRIDGE AND SMART BRIDGE PRO</b>		
LBDG2WH	Smart Bridge with HomeKit Technology	91.69
LBDGPR02WH	Smart BridgePRO with HomeKit Technology	115.38
<b>PICO REMOTE AND ACCESSORIES</b>		
PJ23BRLWHL01R	Remote Control	17.49
LPED1WH	LPED1WH Single Tabletop Pedestal	12.97
LPED2WH	Double Tabletop Pedestal	23.29
PIC0CARCLIP	Car Visor Clip	9.48
<b>DIMMERS AND SWITCHES</b>		
PD5NEWH	Dimmer ELV+	111.54
PD6ANSWH	In-Wall Neutral Switch	67.86
PDFSQNW	120V Fan Speed Control	66.37
PD6WCLWH	120V In-Wall Light Dimmer	61.73

Replace WH with IV for Ivory, LA for Light Almond or BL for Black.

Lighting & Lighting Controls



## Photocontrols

### PHOTOCONTROLS FIXED POSITION MOUNT

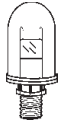

Vendor Code: **TOR**

Catalog Number	Volts	Watts Tungsten	VA Ballast	VA LED	Price Each
<b>KNOCKOUT MOUNT FIXED POSITION</b>					
<b>2000</b>	120	2,000	1,800	600	17.44
<b>2002</b>	208	2,000	1,800	1,385	19.64

### PHOTOCONTROLS PLUG-IN LOCKING MOUNT



- Ideal for roadway, area, parking, flood and security lighting.
- Works with all LED, CFL, induction, HPS and HID lighting fixtures.
- Long life components exceeding the 20 year long-life requirement.
- Life tested up to 10,000 on/off operations with 8 year warranty.
- Instant response, 2-5 second delay off and 510J MOV surge protection.
- Meets ANSI C136.10-2010, UL773, & CSA TIL A15.

Vendor Code: **TOR**

Catalog Number	Volts	Watts Tungsten	VA Ballast	VA LED	Price Each
<b>5237UL</b>	103-305	1,000	1,800	1,000	16.83

### PHOTOCONTROL ACCESSORIES

Vendor Code: **TOR**

Catalog Number	Description	Price Each
<b>2421</b>	Receptacle, 120-480V, Color Coded #12 Leads, Plastic Housing, Lock Nut with 1/2" NPT, and Mounting Bracket.	25.00
<b>5500</b>	Turn Lock, 480V Max, 1,800W Tungsten, 1,800VA Ballast	8.20

Not UL or CSA Listed.

### PHOTOCONTROLS STEM AND SWIVEL MOUNT

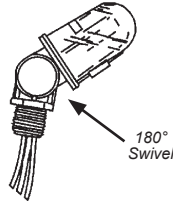

- Conformal coated cadmium sulphide photocell resists effects of moisture and airborne contaminants. Photocell responds to the light spectrum near to that of a human eye.
- Delay of up to two minutes to prevent false switching due to light from passing vehicles, lightning, etc.
- All Lexan® enclosures are impact and vandal resistant.
- Translucent Lexan Dome prolongs cell life by further screening out ultraviolet rays. Dome and base are ultrasonically welded for maximum strength.

Vendor Code: **TOR**

Catalog Number	Volts	Watts Tungsten	VA Ballast	VA LED	Price Each
<b>2001</b>	120	2,000	1,800	600	14.59
<b>2002</b>	208-277	3470-4620	2080-2770	1,385	21.50

### PHOTOCONTROLS LED RATED

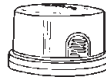

The ZTL Series Photocontrol is designed with enhanced ZERO-CROSS Switching Technology allowing it to withstand the high inrush currents commonly found in LED Luminaires.

- Ideal for roadway, area, parking, flood and security type lighting fixtures.
- Enhanced 510 Joule MOV surge device providing superior surge protection against unpredictable line voltage spikes.
- Circuit Board protection enhanced with conformal coating to protect against extreme weather elements and moisture.

Vendor Code: **TOR**

Catalog Number	Description	Price Each
<b>ZTL124</b>	105-305V, 1000W Tungsten, 1800VA Ballast, 8A LED	23.82

# TORK

### PHOTOCONTROLS STEM MOUNT



- Ideal for commercial and municipal lighting applications.
- Works with all 120 through 277VAC LED, CFL, induction, HPS and HID lighting fixtures.
- Extremely corrosion-resistant for coastal, ocean spray applications.
- Mounts in 1/2" conduit hole commonly found in gang and power distribution enclosures.
- Gasketed for weather protection.
- Meets ANSI/UL773A.

Vendor Code: **TOR**

Catalog Number	Volts	Watts Tungsten	VA Ballast	VA LED	Price Each
<b>DIE CAST ZINC HOUSING AND BASE</b>					
<b>2129A</b>	120/208-277V	2,000	1,800	600	30.76
<b>DIE CAST ALUMINUM HOUSING AND BASE</b>					
<b>2119A</b>	120/208-277V	2,000	1,800	600	20.55

### PHOTOCONTROLS FLUSH MOUNT



- Conformal coated cadmium sulphide photocell resists effects of moisture and airborne contaminants. Photocell responds to the light spectrum near to that of a human eye.
- Delay of up to two minutes to prevent false switching due to light from passing vehicles, lightning, etc.
- Meets ANSI/UL773A.
- Control housing is weather-resistant molded Lexan® with ultrasonically welded seams.
- Flush mounting through 6875" hole in post lantern or lighting fixture, 3/8" NPT, stem 3/4" long. Gasket and nut supplied.

Vendor Code: **TOR**

Catalog Number	Volts	Watts Tungsten	VA Ballast	VA LED	Price Each
<b>3000</b>	120	2,000	1,800	600	12.17
<b>3002</b>	208-277	3470-4620	2080-2770	1,385	19.11

Lighting & Lighting Controls

DIGITAL TIME CLOCKS

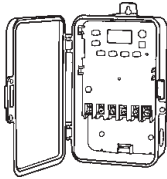

- No reset after power failure
- Multipurpose 7 day, available in 1 and 2 channels
- Permanent schedule retention
- Super capacitor backup
- Multi-voltage input 120-277V AC
- Automatic daylight savings and leap year compensation
- Non-metallic, NEMA 3R enclosure
- Standard or Astronomic Programs (7 Day)
- 40 amp contacts

Vendor Code: **TOR**

Catalog Number	Switch Type	Amps	Channels	Price Each
<b>24 HOUR / NEMA 3R, NON-METALLIC ENCL.</b>				
<b>E101B</b>	SPST	40	1	109.76
<b>E103B</b>	DPST	40	1	150.38
<b>7 DAY / NEMA 3R, NON-METALLIC ENCL.</b>				
<b>EWZ101</b>	SPST	40	1	204.94
<b>EWZ201C*</b>	SPST	30	2	189.99

\*Has an Option for 1 Channel DPST Operation

TIMERS  
SPRING WOUND



A515MW

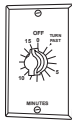

C515M

- Twist knob for time ON setting. Time ON lengths from 15 minutes to 12 hour vary by model.
- No adjustments. Just wire and go!
- No neutral required. Great for retrofit!
- 125/250/277 VAC

Vendor Code: **TOR**

Catalog Number	Switch Type	Length of Time	Price Each
<b>WHITE FACE PLATE INCLUDED</b>			
<b>A515MW</b>	SPDT	15 Minute Max	33.81
<b>A530MW</b>	SPDT	30 Minute Max	34.68
<b>A560MW</b>	SPDT	60 Minute Max	35.91
<b>METAL-BRUSHED ALUMINUM COLOR</b>			
<b>C515M</b>	SPDT	15 Minute Max	40.57
<b>C530M</b>	SPDT	30 Minute Max	41.40
<b>C560M</b>	SPDT	60 Minute Max	42.27

ELECTROMECHANICAL  
TIME CLOCKS  
24 HOUR

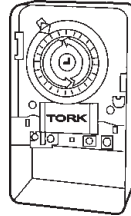

1101NC

- NEMA 3R/NEMA 1 housing
- Clear Lexan cover
- Auto on/off same time 7 days a week

Vendor Code: **TOR**

Catalog Number	Switch Type	Voltage	Price Each
<b>NEMA 3R, NON-METALLIC ENCLOSURE / 40A</b>			
<b>1101BPC</b>	SPST	120	62.30
<b>1103BPC</b>	DPST	120	57.98
<b>1104BPC</b>	DPST	208-277	71.97
<b>SCREW-ON ON/OFF TRIPPERS</b>			
<b>P47</b>	-	-	5.96

DIGITAL TIME SWITCH  
ASTRO WALL TIMER



- Scheduling: 10 ON & OFF pairs of set points for individual programs on each day of the week. 11 day groups speed programming.
- Astronomic/Daylight Savings/Leap Year/Random Mode
- Both models can be used as a 3-way switch.
- Supercapacitor provides power outage backup

Vendor Code: **TOR**

Catalog Number	Input Supply (VAC)	Amps	Action	Price Each
<b>7 DAY ASTRONOMICAL</b>				
<b>SS703Z</b>	120/277	15	SPST	47.04

White Color

ELECTROMECHANICAL  
TIME CLOCKS  
24 HOUR WITH PULLOUT TABS

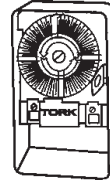

Vendor Code: **TOR**

Catalog Number	Switch Type	Voltage	Price Each
<b>NEMA 1, METAL ENCLOSURE / 20A</b>			
<b>8001</b>	SPDT	120V	226.00
<b>8001U</b>	SPDT	480V	181.24

7 DAY WITH SKIP-A-DAY

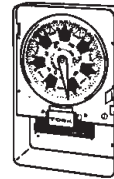

Vendor Code: **TOR**

Catalog Number	Switch Type	Voltage	Price Each
<b>NEMA 1 METAL ENCLOSURE / 40A</b>			
<b>W400B</b>	4PST	120	249.80

**TORK**



### PREMIUM FAN UNITS

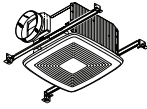

QTXE080



QTXE150

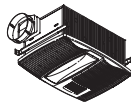

QTX110HL

Vendor Code: **BRO**

Catalog Number	Description	Price Each
<b>QTXE080</b>	80 CFM, 0.3 Sones, Energy Star	148.46
<b>QTXE150</b>	150 CFM, 1.4 Sones, Energy Star	197.60
<b>QTX110HL*</b>	110 CFM, 1.2 Sones w/ Heater, Light, and Nightlight	339.99

\*Lamps for Light and Night Light Not Included with Fan

### INTERMEDIATE FAN UNITS

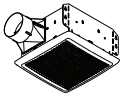

AE50

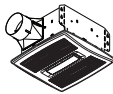

AE80L

Vendor Code: **BRO**

Catalog Number	Description	Price Each
<b>AE50</b>	50 CFM, 0.5 Sones, Energy Star	98.61
<b>AE80B</b>	80 CFM, 1.5 Sones, Energy Star	85.41
<b>AE80</b>	80 CFM, 0.8 Sones, Energy Star	135.29
<b>AE80L</b>	80 CFM, 0.8 Sones, Energy Star, LED Light	219.49
<b>AE110</b>	110 CFM, 1.0 Sones, Energy Star	155.20
<b>AE110L</b>	110 CFM, 1.0 Sones, Energy Star, LED Light	225.17

### ECONOMY FAN UNITS

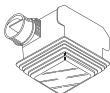

Fan/Light

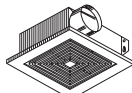

Ceiling/Wall Mount Fan

Vendor Code: **BRO**

Catalog Number	Description	Price Each
<b>FAN/LIGHT</b>		
<b>678*</b>	50 CFM, 2.5 Sones, 4" Duct, 100w Incan. Max	46.99
<b>A70L*</b>	70 CFM, 2.0 Sones, 4" Duct, 100w Incan.Max	77.89
<b>CEILING MOUNT FAN ONLY</b>		
<b>A110</b>	110CFM, 3.0 Sones, 4" Duct	83.99
<b>CEILING/WALL MOUNT FAN</b>		
<b>688</b>	50 CFM, 4.0 Sones, 3" Duct	22.99
<b>HEATER/FAN</b>		
<b>658</b>	70 CFM, 4.0 Sones, 4" Duct, 1300w Heater	145.99
<b>HEATER/FAN/LIGHT</b>		
<b>655</b>	70 CFM, 4.0 Sones, 4" Duct, 1300w Heater	121.99

\*Lamps Not Included

### RECESSED FAN/LIGHT WITH HIDDEN VENTILATION

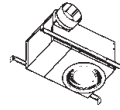

Vendor Code: **BRO**

Catalog Number	Description	Price Each
<b>744*</b>	70 CFM, 1.5 Sones, 75w Max	129.99

Accepts R30, BR30, PAR30, or PAR30LN  
\*Lamps Not Included

### CHIMES AND CHIME KITS



Vendor Code: **NUT**

Catalog Number	Description	Price Each
<b>LA174WH*</b>	Recessed Westminster Electronic Chime	109.99
<b>BK110NBWH</b>	Non-Lighted Button Kit: One 2-Note, White Door Chime Assembly	18.99
<b>BK115LWH</b>	Lighted Button Kit: One 2-Note, White Door Chime	20.99
<b>BK125LWH</b>	Lighted Button Kit: One 2-Note, White Door Chime, 2 Pushbuttons	21.99
<b>C905</b>	16V 10VA Transformer for Door Chime	16.79
<b>C907</b>	16V 13VA Transformer for Multiple Door Chimes	25.30

\*Pushbutton Not Included

### COMBINATION SWITCHES



66V or 66W



82W

Vendor Code: **BRO**

Catalog Number	Description	Price Each
<b>66V</b>	120v, 20 Amp Multi-Function Wall Switch; Ivory	27.70
<b>66W</b>	120v, 20 Amp Multi-Function Wall Switch; White	27.70
<b>82W</b>	120v, Humidity Sensing Wall Control; White	48.15

### UPGRADE KITS



Vendor Code: **NUT**

Catalog Number	Description	Price Each
<b>LED GRILLE UPGRADE</b>		
<b>FG500NS</b>	LED Grille Upgrade Kit for Ventilation Fans	35.56
<b>BATHROOM FAN UPGRADE KIT</b>		
<b>690</b>	60 CFM Motor Upgrade w/Grille	47.99



**SMOKE/CO ALARMS**

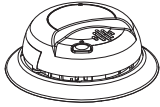

SC9120B/SC9120LBL  
9120B/9120LBL



SC0500B/SA511B



SA350B



FG250B

**SC9120B**

Hardwired ionization and CO combination alarm meets new construction requirements including an advanced electrochemical CO and ionization smoke sensing technologies and a ten year CO Sensor/End of Life signal.

**SC9120LBL**

Wire-in, 120V AC 60Hz single and/or multiple station smoke and CO alarm specifically designed for residential and institutional applications. This alarm features a 10 year battery backup. The battery drawer is shipped pre-locked so battery will not be discarded prematurely.

**SC0500B**

BRK Wireless Interconnect Alarms provide a cost effective solution when it comes to renovation and retrofit projects where interconnectability is a requirement. Easily interconnect between floors and new to existing construction wirelessly.

**9120LBL**

Features a dual ionization smoke sensing chamber, an 85Db horn and a "silence" feature. This alarm has a 10 year battery backup. The battery drawer is shipped pre-locked so battery will not be discarded prematurely. Under normal conditions you should not have to replace the battery for the life of the alarm.

**SA350B**

Provides full 10-years of protection. Sealed Tamper proof design eliminates removal of batteries for other uses and ensures operation over the life of the alarm.

**FG250B**

Basic battery operated smoke alarm perfect for use in existing multi-family applications.

**SA511B**

BRK Wireless Interconnect Alarms provide a cost effective solution when it comes to renovation and retrofit projects where interconnectability is a requirement. Easily interconnect between floors and new to existing construction wirelessly.

Vendor Code: **BRK**

Catalog Number	Description	Price Each
SC9120B*	120V Combo Smoke and CO w/ Battery Backup	47.99
SC9120LBL*	120V Combo Smoke and CO w/ 10 Year Extended Life	54.99
SC0500B**	Wireless Interconnect Combo Smoke and CO w/Voice	64.99
SMOKE ALARMS		
9120B*	120V AC with Battery Backup	13.49
9120LBL*	120V AC/DC Ionization Smoke Alarm with a 10 Year Lithium Battery Back-up.	23.99
SA350B	10 Year Sealed Tamper Proof Battery Powered	23.99
FG250B	9V Battery Smoke Alarm	9.39
SA511B**	Wireless Interconnect Smoke w/Voice	47.99

\*Hardwired

\*\*Requires Two AA Batteries

**HEATERS**

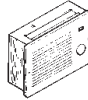

174



198

Vendor Code: **BR0**

Catalog Number	Description	Price Each
174	1,500W Wall Heater, 8-9/16" x 12-9/16" x 4"	119.99
198	4,000W Wall Heater, 17-3/4" X 21-5/8" X 3-3/4"	329.99

**CEILING HEATER  
LOW PROFILE**

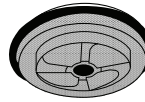

Vendor Code: **BR0**

Catalog Number	Volts	Watts	Amps	Price Each
157	120	1,250	10.7	89.99

**INFRARED LAMP HEATERS**

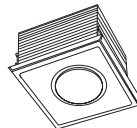

161

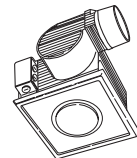

162

Vendor Code: **BR0**

Catalog Number	Description	Price Each
161	250W Bulb Heater without Vent	37.99
162	70 CFM Exhaust Single Bulb Heater Fan	66.99

Does Not Include Lamps

**FLEXIBLE VINYL DUCTING**

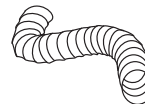

Vendor Code: **DTC**

Catalog Number	Description	Price Each
BH350W	3" x 50' Flex Vinyl Duct Hose	17.59
BH450W	4" x 50' Flex Vinyl Duct Hose	18.79



Lighting & Lighting Controls



D

Wire & Cable

SECTION



Wire & Cable



Wire & Cable

Pulling

Simpull® Coilpak Payoff.....	D4
Poly Pull Tape .....	D4
Maxis Equipment.....	D4

Wire & Cable

Underground.....	D5-D6
Drop .....	D5
Service Entrance .....	D5-D6
THHN, TFFN, XHHW .....	D5
Non-Metallic Sheathed (Romex®).....	D6
Portable Cord.....	D7
Grips .....	D7
Thermostat.....	D7
SPT.....	D7
Armored Cable.....	D8
Hospital .....	D8



Wire & Cable



**See how Elliott Electric Supply can reduce your wire pulling installation time up to 90%!\* Saving Approximately 24 man hours at \$75/hour means a \$1800 savings over a traditional wire pull installation!**

### Elliott Service: Southwire® SIMpull® Solution (requires 3 men)

**STEP 1 (60 man-minutes):** One reel of SIMpull THHN® cable with 5 parallel color conductors arrive at job site, unload, transport to pull site, level reels on jacks

**STEP 2 (30 man-minutes):** Pull rope & rag through conduit

**STEP 3 (3 man-minutes):** Attach SIMpull Head™ pulling "grips" to pull rope

**STEP 4 (6 man-minutes):** Set up lightweight Maxis® tugger

**STEP 5 (60 man-minutes):** Start pull, pulling speed average 12 feet per minute

**Total: 159 man-minutes**

**1650 man-minutes - 159 man-minutes =  
1491 saved man-minutes**

**1491 man-minutes / 60 = 24.85 saved man-hours**

### Traditional Wire Pulling Installation (requires 6 men)

**STEP 1 (420 man-minutes):** 4 x 250 black conductors with ground arrive at job site, unload, transport to pull site, level reels on jacks

**STEP 2 (60 man-minutes):** Transport lube bucket and rags to pull site

**STEP 3 (120 man-minutes):** Phase tape and check circuits

**STEP 4 (60 man-minutes):** Pull rope and rag through conduit

**STEP 5 (300 man-minutes):** Make up conductor head and attach to pull rope

**STEP 6 (180 man-minutes):** Set up tugger

**STEP 7 (180 man-minutes):** Set up to apply lube to head, at start of pull, and at pull boxes

**STEP 8 (240 man-minutes):** Start pull, apply lube at 2 location, pulling speed 6 feet per minute

**STEP 9 (90 man-minutes):** Clean lube off conductors and enclosure

**Total: 1650 man-minutes**

**Vs.**

**Below are some of our wire services.  
Ask for pricing and details.**

#### Wire Cutting

Hauling around more wire than you need can waste space and increase fuel consumption. For a small fee, Elliott Electric Supply can cut your wire to your specified foot length, so you can have what's required for your job while reclaiming precious space and reducing costs.

#### Wire Paralleling

Elliott Electric Supply can help get your job done quicker with paralleled reels. If your job requires multiple conductors going through the same space, why not have them put on a reel together? This small step can save time, labor, cost, headaches and sometimes, sanity.

#### Pulling Heads Installation

Installing pulling heads takes significant time away from other labor needs and can be frustrating when not done correctly. Let a professional help from Elliott Electric Supply. Our employees have been trained on proper installation techniques, so you can rely on our pulling heads performing as required.

#### SimPull Reel Rentals

Are you struggling with unwinding wire from a stationary reel? Elliott Electric Supply offers Sim-Pull Reel Rentals so you can unroll your wire with ease.

#### Trailer/Truck & A-frame Rentals

If you don't have the means (or don't want) to lug reels to your jobsite, you can rent a loaded trailer or truck for a few hours from Elliott Electric Supply. You can pull wire right from the trailer, expediting your pulls. Just let us know when you're done, and we'll clear it out. We can also rent A-frames, where we'll load it on the frame for you, so you can just drop the whole thing on the job site, and you're ready to go!



© Southwire, SIMpull THHN, SIMpull Head and Maxis are registered names of Southwire Company.  
\*Time savings comparison data from Southwire.com.

**D**  
**Wire & Cable**

SIMPULL® COILPAK™ PAYOFF



SIMPull® CoilPAK™ Wire Payoff



SIMPull® CoilPAK™ Mini Wire Payoff

Vendor Code: COP

Catalog Number	Description	Feet	Price per 1,000 ft.
<b>COILPAK</b>			
THHN14STBKCP2500	14 Stranded	2,500	78.66
THHN12SLBKCP2000	12 Solid	2,000	101.71
THHN12STBKCP2000	12 Stranded	2,000	108.96
THHN10SLBKCP1250	10 Solid	1,250	169.72
THHN10STBKCP1250	10 Stranded	1,250	177.75
<b>COILPAK MINI</b>			
THHN12SLBKMINICP	12 Solid	1,000	101.71
THHN12STBKMINICP	12 Stranded	1,000	108.96

Catalog Numbers Listed Above are Black (BK).

Replace BK with BL for Blue, BR for Brown, GN for Green, GY for Grey, OR for Orange, PR for Purple, RD for Red, WH for White, or YL for Yellow.

POLY PULL TAPE



Vendor Code: DOT

Catalog Number	Width x Length	Tensile Strength (lbs.)	Price Each
DWP500	1/2" x 500'	1250	98.96
DWP502	3/4" x 500'	2500	104.98
DWP1500	1/2" x 1500	1250	332.10
DWP1502	3/4" x 1500	2500	576.52
DWP3000	1/2" x 3000'	1250	358.58
DWP3002	3/4" x 3000'	2500	470.08



SIMPULL™ FLANGE



The SIMpull™ Flange's patented shaft less design, safely allows one person to turn a wooden or plastic reel up to 34 in. and 2,000 lbs into a time saving, field-installable solution that removes the need to handle heavy jack stands. Each flange rotates independently, and allows free movement of loaded wooden or plastic reels. The SIMpull™ Flange is reusable in the field and can be installed on multiple reels throughout the jobsite.

Vendor Code: COP

Catalog Number	Description	Price Each
SIMPULLFLANGE	SIMPULL Reel Flange Kit with Magnetic Chocks	5000.00

MAXIS® CABLE PULLERS

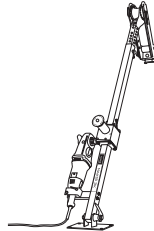

M3KM

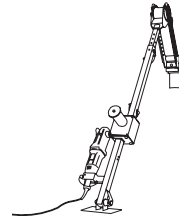

M6KM

M3KM and M6KM

- One person, 2 minute set up and operate
- Quickly adapts from underground to overhead pulls
- No need to bolt to the ground on most pulls
- 2 Pulling speeds:
  - M3KM** - 25 fpm on low (at no load) and 100 fpm on high (at no load)
  - M6KM** - 12 fpm on low (at no load) and 44 fpm on high (at no load)

Vendor Code: MXT

Catalog Number	Description	Price Each
M3KM	3,000 Pound Cable Puller	5003.08
M6KM	6,000 Pound Cable Puller	8043.62

MAXIS® TRIGGERS®

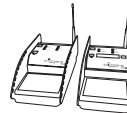

- Communicates up to 1,500' between walls and up to 1.5 miles line of sight
- Stop the cable pull from either end immediately. Eliminate safety issues associated with feeding wire

Vendor Code: MXT

Catalog Number	Description	Price Each
TSS01	Dual Remote Foot Switch	3331.73

MAXIS® JAX™ REEL STAND

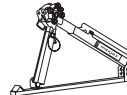

A unique reel stand that will quickly set up and lift reels of wire safely and efficiently without the hassle of conventional reel stands.

- Breaks down into a compact storable tool.
- Lifts wire reels off the ground
- Max lever allows one person to lift wire reels off the ground with minimal effort

Vendor Code: MXT

Catalog Number	Description	Price Each
MJ707	3,000 lbs. Reel Stands (Pair)	800.90





## ALUMINUM URD UNDERGROUND CABLE



Vendor Code: **ALU**

Catalog Number	Conductor Size	Trade Name	Price per 1,000 ft.
<b>3 CONDUCTOR</b>			
URD4	4-4-4	Vassar	762.05
URD2	2-2-4	Stephens	974.86
URD10	1/0-1/0-2	Brenau	1183.36
URD20	2/0-2/0-1/0	Converse	1411.20
URD30	3/0-3/0-1/0	Hollins	1650.49
URD40	4/0-4/0-2/0	Sweetbriar	1875.86
<b>4 CONDUCTOR</b>			
URD2224	2-2-2-4	Dyke	1419.58
URD10101021000	1/0-1/0-1/0-2	Notre Dame	1617.66
URD20202011500	2/0-2/0-2/0-1	Syracuse	1917.52
URD404040201500	4/0-4/0-4/0-2/0	Wake Forest	2681.43
<b>MOBILE HOME FEEDER CABLE</b>			
URD40402041000	4/0-4/0-2/0-4	-	2835.43

## ALUMINUM SERVICE DROP CABLE



Vendor Code: **ALU**

Catalog Number	Conductor Size	Trade Name	Price per 1,000 ft.
6TRIPLEX	#6	Voluta	528.78
4TRIPLEX	#4	Periwinkle	660.33
2TRIPLEX	#2	Conch	871.34

## ALUMINUM SERVICE ENTRANCE CABLE

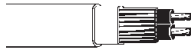

Vendor Code: **ALU**

Catalog Number	Conductor Size	Price per 1,000 ft.
<b>3 CONDUCTOR</b>		
SEU63	6-6-6	612.93
SEU43	4-4-4	827.89
SEU2241000	2-2-4	962.90
SEU23	2-2-2	1120.09
SEU4461000	4-4-6	750.34
<b>4 CONDUCTOR</b>		
SER6666	6-6-6-6	820.56
SER4446	4-4-4-6	930.88
SER2224	2-2-2-4	1355.06
SER11131000	1-1-1-3	1764.45
SER201000	2/0-2/0-2/0-1	2331.41
SER40	4/0-4/0-4/0-2/0	2934.25



Try QuickSelect Now!  
Cables

## TYPES THHN AND TFFN (COPPER)

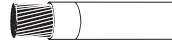

Vendor Code: **COP**

Catalog Number	Lbs. per 1,000 ft.	Allowable Amps	Conduit Size*	Price per 1,000 ft.
<b>SOLID WIRE</b>				
THHN14S0LBK500	17	25	1/2"	65.61
THHN12S0LBK500	24	30	1/2"	88.06
THHN10S0LBK500	37	40	1/2"	146.97
<b>STRANDED WIRE</b>				
TFFN18STBK500	9	14	1/2"	38.00
TFFN16STBK500	12	18	1/2"	51.99
THHN14STBK500	17	25	1/2"	68.09
THHN12STBK500	24	30	1/2"	94.35
THHN10STBK500	39	40	1/2"	153.89
THHN8BK500	63	55	3/4"	249.01
THHN6BK	98	75	3/4"	383.12
THHN4BK	157	95	1"	615.11
THHN3BK	187	110	1-1/4"	775.81
THHN2BK	232	130	1-1/4"	971.08
THHN1	298	150	1-1/4"	1220.68
THHN10	368	170	1-1/2"	1494.51
THHN20	458	195	2"	1840.98
THHN30	570	225	2"	2323.37
THHN40	711	260	2"	2900.19
THHN250	848	290	2-1/2"	3360.59
THHN350	1,169	350	3"	4718.94
THHN500	1,648	430	3"	6782.97
THHN600	1,987	475	3"	8614.39

Available in Colors.  
Minimum Conduit Size for Four Conductors.  
SMPull Requires No Lube.  
See Page L9 for Conduit Fill Table.

## TYPE XHHW (ALUMINUM-COMPACT STRAND)

Vendor Code: **ALU**

Catalog Number	Lbs. per 1,000 ft.	Allowable Amps	Conduit Size*	Price per 1,000 ft.
XHHW6	42	60	3/4"	156.23
XHHW4	58	75	1"	193.00
XHHW2	86	100	1-1/4"	261.51
XHHW1	110	115	1-1/4"	382.66
XHHW20	163	150	1-1/2"	533.04
XHHW30	200	175	2"	630.55
XHHW40	247	205	2"	700.90
XHHW250	269	230	2"	855.60
XHHW300	349	255	2-1/2"	1241.93
XHHW350	401	255	2-1/2"	1285.38
XHHW400	452	280	2-1/2"	1502.69
XHHW500	556	350	3"	1657.31
XHHW600	679	385	3-1/2"	2100.28
XHHW750	833	435	4"	2449.61

Available in Colors  
\*Minimum Conduit Size for Four Conductors  
See Page L10 for Conduit Fill Table.  
XHHW is Now Available in Copper Conductors  
THHN is Now Available in Aluminum Conductors

FOR WIRE SPECIFICATIONS AND VOLTAGE DROP INFORMATION,  
SEE PAGE L8

NOTICE: Prices shown on Pages D4 and D5 are based on Comex at \$2.77 per pound, prices will change weekly.  
Visit [ElliottElectric.com](http://ElliottElectric.com) for current pricing.

D  
Wire & Cable



**NON-METALLIC SHEATHED CABLE (ROMEX®)**



Vendor Code: **COP**

Catalog Number	Size	Lbs. per 1,000 ft.	Ctn. Qty.	Price per 1,000 ft.
<b>2 CONDUCTOR WITH GROUND</b>				
RX142WG250	14	58	250*	154.98
RX122WG250	12	85	250*	229.56
RX102WG250	10	126	250*	410.30
RX82WG	8	189	500	684.39
RX62WG	6	258	500	966.60
<b>3 CONDUCTOR WITH GROUND</b>				
RX143WG250	14	76	250*	218.21
RX123WG250	12	109	250*	333.03
RX103WG250	10	167	250*	527.36
RX83WG	8	270	500	963.51
RX63WG	6	360	500	1408.09
RX43WG	4	563	500	3762.15

\*Available in 250' Cartons & 1,000' Reels; Additional \$2 Charge for 1,000' Reels.

Vendor Code: **COP**

Catalog Number	Size	Price per 1,000 ft.
<b>NM SHEATHED CABLE WITH TWISTED PAIR CONTROL CABLE</b>		
RXPCS142WG200	14/2 WG + 16/2 Control	496.37
RXPCS122WG200	12/2 WG + 16/2 Control	633.94

\*Available in 1000' Reels for an Additional Charge

**UNDERGROUND FEEDER (UF) (RATED FOR DIRECT BURIAL)**

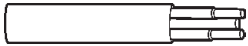

Vendor Code: **COP**

Catalog Number	Size	Lbs. per 1,000 ft.	Ctn. Qty.	Price per 1,000 ft.
<b>2 CONDUCTOR WITH GROUND</b>				
UF142WG250	14	70	250	184.22
UF122WG250	12	108	250	282.37
UF123WG250	12	130	250	396.41
UF102WG250	10	141	250	446.61
UF82WG	8	223	500	741.27
UF62WG	6	304	500	1041.92

1,000' Reels Also Available.



Try QuickSelect Now!  
Non-Metallic Sheath Cable

®Romex is a registered trademark of Southwire® company.

**SERVICE ENTRANCE CABLE COPPER CONDUCTOR**



Vendor Code: **COP**

Catalog Number	Size	Lbs. per 1,000 ft.	Price per 1,000 ft.
<b>TYPE SEU CABLE - 3 CONDUCTOR</b>			
SEU63	6	328	1247.10
SEU43	4	491	1956.02
SEU203	2/0	1,371	6432.72
<b>TYPE SER CABLE - 4 CONDUCTOR</b>			
SER4446CU1000	4	587	2935.10
SER34500	3	722	3945.18
SER241000	2	891	4597.44
SER13WG500	1	1,117	5768.46
SER20WG500	2/0	1,713	9077.37
SER30WG500	3/0	2,129	11382.54

**NON-METALLIC SHEATH CABLE CONNECTORS WITH LOCKNUT**



Vendor Code: **BRI**

Catalog Number	Size	Carton Quantity	Price per 100 pcs.
650DC2	1/2"	100	46.95
670DC2	3/4"	25	99.95
672DC2	1"	10	190.72
674DC2	1-1/4"	10	244.80
675DC2	1-1/2"	25	387.60
676DC2	2"	25	459.02

**SAFETY NAIL PLATE**

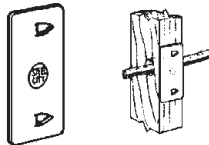

Vendor Code: **BRI**

Catalog Number	Size	Carton Quantity	Price per 100 pcs.
732SP	1-1/2" x 2-3/4"	100	14.27

NOTICE: Prices shown are based on Comex at \$3.55 per pound, prices will change weekly.

Visit [ElliottElectric.com](http://ElliottElectric.com) for current pricing.

**STAPLES (NON-METALLIC SHEATH CABLE CONNECTORS & SEU)**



Vendor Code: **TAB**

Catalog Number	Max. Wire Size	Ctn. Qty.	Price per 100 pcs.
17120TB	14/2 WG or 12/2 WG	100	6.45
17130TB	14/2 WG or 12/2 WG	500	6.89
17122TB	12/3 or 10/3	100	8.51
17132	12/3 or 10/3	500	6.70
17123	6/3 SEU	100	16.54

**PLASTIC NON-METALLIC SHEATH CABLE CONNECTORS**



Vendor Code: **ARL**

Catalog Number	Description	Ctn. Qty.	Price per 100 pcs.
<b>FOR SINGLE AND MULTIPLE CABLES</b>			
NM94	1/2" Snap-in Connection	25	17.82
NM95	3/4" Snap-in Connection	50	35.06

**PLASTIC KNOCK OUT BUSHINGS**

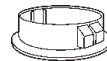

Vendor Code: **BRI**

Catalog Number	Size	Carton Quantity	Price per 100 pcs.
9791	1/2"	100	19.56
9792	3/4"	100	24.15
9793	1"	50	37.98
9794	1-1/4"	50	48.87
9795	1-1/2"	25	56.36
9796	2"	20	79.97

Vendor Code: **DOT**

1216D	2-1/2"	25	126.31
-------	--------	----	--------



Wire & Cable D



## Cable (Portable Cord · Cord Connectors · Bus Drop Grips · Thermostat Wire)

### PORTABLE C ORD 600 VOLT TYPE SEOWW SEOPRENE™ JACKET

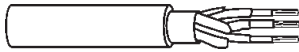

Flexible and tough jacket. Offers -50°C to 105°C temperature extremes. Excellent abrasion, ozone, sunlight, chemical and oil resistance, with water and mold resistant non-wicking lightweight polypropylene fillers. Water resistant with high dielectric insulation. Lightweight, long lasting, easy to carry and easy to handle. All components are recyclable and non-hazardous for environmental landfill disposal. Color coded conductors for easy identification.

Special uses requiring flexibility and mechanical toughness, high environmental resistance and flame retardant. Push button remote control, stage equipment and lighting. Industrial control and robotic systems. Outdoor applications. Suitable and approve for submersion in water.

Vendor Code: **COR**

Catalog Number	Size	Insulation	Nom. O.D.	Price per 1,000 ft.
SE00W183BK250	18/3	0.031	0.365	370.45
SE00W163BK250	16/3	0.032	0.390	490.03
SE00W164BK250	16/4	0.032	0.420	661.07
SE00W143BK250	14/3	0.045	0.525	729.15
SE00W144BK250	14/4	0.045	0.575	955.85
SE00W123BK250	12/3	0.045	0.595	1089.70
SE00W124BK250	12/4	0.045	0.645	1275.49
SE00W103BK250	10/3	0.045	0.665	1430.32
SE00W104BK250	10/4	0.045	0.705	1606.14
SE00W83BK250	8/3	0.045	0.701	2055.32
SE00W84BK250	8/4	0.045	0.783	2576.59
SE00W63BK250	6/3	0.060	0.818	2909.42
SE00W64BK250	6/4	0.060	0.892	3506.94
SE00W44BK250	4/4	0.060	1.104	6175.32

### 300 VOLT TYPE SJEW SEOPRENE™ JACKET

Vendor Code: **COR**

Catalog Number	Size	Insulation	Nom. O.D.	Price per 1,000 ft.
SJEW163BK250	16/3	0.032	0.330	437.65
SJEW164BK250	16/4	0.032	0.335	473.95
SJEW143BK250	14/3	0.032	0.370	652.91
SJEW123BK250	12/3	0.032	0.430	754.72

NOTICE: Prices shown are based on Comex at \$3.55 per pound, prices will change weekly.

Visit [ElliottElectric.com](http://ElliottElectric.com) for current pricing.



## Southwire®

### CORD CONNECTORS



NON-METALLIC

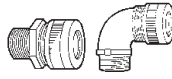

METALLIC

Vendor Code: **TAB** (ABB Installation Products)

Catalog Number	Cord Range	NPT Size	Ctn. Qty.	Price per 100 pcs.
<b>STRAIGHT BODY, NON-METALLIC</b>				
2920NM	.125 - .375	1/2"	25	785.08
2921NM	.310 - .560	1/2"	25	785.08
2922NM	.500 - .750	1/2"	25	785.08
2932NM	.500 - .750	3/4"	10	862.63
<b>STRAIGHT BODY, METALLIC</b>				
2920	.125 - .375	1/2"	25	846.46
2921	.310 - .560	1/2"	25	846.46
2922	.500 - .750	1/2"	10	846.46
2930	.125 - .375	3/4"	10	978.46
2931	.310 - .560	3/4"	10	978.46
2932	.500 - .750	3/4"	10	978.46
2942	.700 - .950	1"	10	1228.40

Vendor Code: **CRS** (Eaton Crouse-Hinds Series)

Catalog Number	Cord Range	NPT Size	Ctn. Qty.	Price per 100 pcs.
<b>STRAIGHT BODY, METALLIC</b>				
CG50250	.15 - .25	1/2"	25	853.37
CG50350	.25 - .35	1/2"	25	853.37
CG50450	.35 - .45	1/2"	25	853.37
CG50560	.45 - .56	1/2"	25	853.37
CG50650	.56 - .65	1/2"	25	853.37
CG75250	.15 - .25	3/4"	10	947.79
CG75350	.25 - .35	3/4"	10	947.79
CG75450	.35 - .45	3/4"	10	947.79
CG75560	.45 - .56	3/4"	10	947.79
CG75650	.55 - .65	3/4"	10	947.79
CG75750	.65 - .75	3/4"	10	947.79
CG100650	.56 - .65	1"	5	997.98
CG100750	.65 - .75	1"	5	997.98
CG100850	.75 - .85	1"	5	997.98
CG100950	.85 - .95	1"	5	997.98

### STRAIN RELIEF GRIPS BOX CONNECTOR



Vendor Code: **PAS**

Catalog Number	Size	Cable Range	Price per 100 pcs.
BOX30	1/2"	.30 - .40	2139.14
BOX40	1/2"	.40 - .54	2268.36
BOX52	3/4"	.52 - .73	2352.09
BOX70	1"	.70 - .97	2904.53
<b>DELUXE GRIPS</b>			
CG410	1/2"	.56 - .61	5053.86
CG612	3/4"	.67 - .74	6145.13

### BUS DROP GRIPS



Vendor Code: **PAS**

Catalog Number	Cable Range	Price per 100 pcs.
FC40	.40 - .56	1608.66
FC52	.52 - .73	1835.24
FC70	.70 - .97	2765.39

### THERMOSTAT WIRE (PLASTIC JACKETED)



Vendor Code: **COR**

Catalog Number	Size	Feet per Spool	Price per 1,000 ft.
552020507	20/2	500	80.27
552030507	20/3	500	106.99
552040407	20/4	250	159.59
552050407	20/5	250	201.18
552060407	20/6	250	211.73
552080407	20/8	250	324.03

18 Gauge Also Available

### TYPE SPT 300 VOLT LAMP CORD

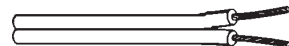

Vendor Code: **COR**

Catalog Number	Size	Feet per Spool	Price per 1,000 ft.
600006607	18/2	250	166.11
601266607	16/2	250	312.13

**ARMORED CABLE**  
250 FT. COILS



MC COIL

Vendor Code: **ALF**

Catalog Number	Size	Lbs. per 1,000 ft.	Price per 1,000 ft.
<b>ALUMINUM JACKET – SOLID CONDUCTORS</b>			
MC142BKWH	14/2 WG	85	423.44
MC143BKRDWH	14/3 WG	105	698.05
MC122BKWH	12/2 WG*	110	424.70
MC123BKRDWH	12/3 WG*	140	740.56
MC124BKRDBLWH	12/4 WG*	170	1039.05
MC102BKWH	10/2 WG*	250	953.69
MC103BKRDWH	10/3 WG*	250	1331.86
MC104BKRDBLWH	10/4 WG*	250	2083.92
<b>ALUMINUM JACKET – STRANDED CONDUCTORS</b>			
MC122STBKWH	12/2 WG	110	586.50
MC82WG	8/2 WG	270	1234.50
MC83WG	8/3 WG	335	1732.18
MC62WG	6/2 WG	370	1822.09
MC63WG	6/3 WG	480	2722.06
MC43WG	4/3 WG	690	3435.02
MC33WG	3/3 WG	815	4418.50
<b>STEEL JACKET – SOLID CONDUCTORS</b>			
SMCBL122BKWH	12/2 WG	117	413.36
SMCBL123BKRDWH	12/3 WG	140	720.84
SMCBL124BKRDBLWH	12/4 WG	170	1011.31
SMCBL102BKWH	10/2 WG	220	928.24
SMCBL103BKRDWH	10/3 WG	270	1296.25

**ARMORED POWER AND CONTROL SIGNAL CABLE**

Vendor Code: **ALF**

Catalog Number	Size	Price per 1,000 ft.
<b>STEEL JACKET – SOLID POWER CONDUCTORS - TWISTED PAIR CONTROL CONDUCTORS</b>		
MCPCS122BKWH250	12/2 WG+ 16/2	976.81
MCPCS123BKRDWH250	12/3 WG+ 16/2	1226.74

\*Available in Various Power Conductor Colors and with Stranded Power conductors, Control Conductors are TFN 16/2 Solid Purple/Gray conductors. Also Available in 1,000' Reels

**HOSPITAL FACILITIES CABLE**

Vendor Code: **ALF**

Catalog Number	Size	Lbs. per 1,000 ft.	Price per 1,000 ft.
<b>ALUMINUM JACKET – SOLID CONDUCTORS</b>			
HCF122BKWH	12/2 WG	133	698.68
HCF123BKWHRD	12/3 WG	155	1024.19
HCF124WG250	12/4 WG	185	1602.53

1,000' Reels Also Available

HCF, or Hospital Grade Cable, is constructed in the same manner as standard AC cable, but with the addition of a green grounding conductor. This additional ground allows HCF to be used in patient care areas of healthcare facilities including hospitals, nursing homes dental offices, outpatient facilities and medical centers per NEC 517.13.



**ARMORED CABLE**  
SNAP-IN CONNECTORS



AMC50QI

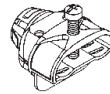

3838ASP



38AST or 40AST

Vendor Code: **BRI** (Bridgeport Fittings)

Catalog Number	Trade Size	Type	Carton Quantity	Price per 100 pcs.
<b>14/2 - 10/3 AC/MC CABLE</b>				
AMC50QI	3/8"	EZ Lock Connector - Steel	50	92.82
AMC52QI	3/8"	Duplex EZ Lock Connector	25	211.12
3838ASP	3/8"	Duplex Push-In Insulated	20	237.28

Vendor Code: **ARL** (Arlington Industries)

Catalog Number	Trade Size	Type	Carton Quantity	Price per 100 pcs.
<b>.405 - .612 CABLE RANGE</b>				
38AST	3/8"	Snap-in Insulated Diced Cast	50	113.60
40AST	3/8"	Snap-in Insulated w/ Red Tint Diecast	50	113.60

\*Red Tinting Means "Open Tang" Design, Which Allows More Room for Insertion of Wires.

**ARMORED CABLE**  
SCREW-TYPE CONNECTORS

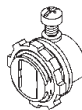

501DC2

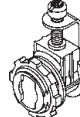

560DC2

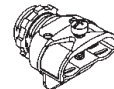

601DC2



1000 or 1001

Vendor Code: **BRI**

Catalog Number	Size	Carton Quantity	Price per 100 pcs.
<b>SET SCREW</b>			
501DC2	3/8"	100	36.72
<b>SET SCREW - SADDLE STRAP TYPE</b>			
560DC2	3/8"	50	91.79
561DC2	3/4"	50	295.79
<b>DUPLEX</b>			
601DC2	1/2"	20	132.58
<b>ANTI-SHORT BUSHINGS</b>			
1000	0	50	14.97
1001	1	50	16.58

**MC STRAPS**



Vendor Code: **BRI**

Catalog Number	Size	Carton Quantity	Price per 1,000 ft.
890MC	14/2, 12/2	100	15.17
891MC	14/3, 12/3	100	22.97



E

Conduit, Fittings & Boxes

SECTION



# Conduit, Fittings & Boxes



## Conduit, Fittings &amp; Boxes

## Conduit

EMT .....	E3–E4
IMC .....	E5
Myers Hubs .....	E5
Aluminum Rigid .....	E5
Threadless Fittings .....	E5
Bushings, Locknuts .....	E6
Nipples, Elbows .....	E7
PVC .....	E8–E9
Flexible .....	E10
ENT .....	E10
Liquid-Tight .....	E11

## Condulets

Series 5 .....	E12
Form 5 .....	E13
Form 7 .....	E14

## Channels

Channels .....	E15–E16
----------------	---------

## Specialty Conduit

PVC Coated .....	E17
Stainless Steel .....	E18

## Fasteners

Fasteners .....	E19–E21
-----------------	---------

## Boxes

Brackets .....	E22–E23
Fan Boxes .....	E23
Metal Boxes .....	E24–E28
Floor Boxes .....	E29
Plastic Boxes .....	E30
Weatherproof Boxes .....	E31–E34





## EMT Conduit · EMT Elbows · Set Screw Couplings · Set Screw Connectors

### EMT CONDUIT



- Republic's unique diamond knurl pattern reduces contact surface area, speeding up installation.
- Proprietary Silverslick coating provides a smoother surface at the point of contact, easing wire pull and push.
- Special steel chemistry makes Republic's EMT the easiest conduit to bend currently available in the marketplace.

Vendor Code: **CON**

Catalog Number	Size	Bundle Size	Lift Size	Price per 100 feet
<b>EMT12</b>	1/2"	100	7,000	37.09
<b>EMT34</b>	3/4"	100	5,000	65.53
<b>EMT1</b>	1"	100	3,000	120.02
<b>EMT114</b>	1-1/4"	50	2,000	194.96
<b>EMT112</b>	1-1/2"	50	1,500	238.38
<b>EMT2</b>	2"	30	1,200	279.24
<b>EMT212</b>	2-1/2"	10	610	453.83
<b>EMT3</b>	3"	10	510	575.29
<b>EMT312</b>	3-1/2"	10	370	759.65
<b>EMT4</b>	4"	10	300	778.75

Bending Instructions: **Page L19**  
2-1/2" Through 4" is Same O.D. as Rigid Conduit.

### EMT ELBOWS 90°, 45°, 30°



Vendor Code: **ROB**

Catalog Number	Size	Weight per 100	Ctn. Qty.	Price per 100 pcs.
<b>90 DEGREE ELBOWS</b>				
<b>EMT1290</b>	1/2"	28	50	397.43
<b>EMT3490</b>	3/4"	46	50	436.55
<b>EMT190</b>	1"	86	25	664.92
<b>EMT11490</b>	1-1/4"	148	25	757.02
<b>EMT11290</b>	1-1/2"	198	20	881.95
<b>EMT290</b>	2"	286	10	1293.25
<b>EMT21290</b>	2-1/2"	536	1	3154.30
<b>EMT390</b>	3"	720	1	4706.20
<b>EMT31290</b>	3-1/2"	1,080	1	6813.32
<b>EMT490</b>	4"	1,330	1	8024.55
<b>45 DEGREE ELBOWS</b>				
<b>EMT11445</b>	1-1/4"	148	25	757.02
<b>EMT11245</b>	1-1/2"	198	20	881.95
<b>EMT245</b>	2"	286	10	1293.25
<b>EMT21245</b>	2-1/2"	536	1	3406.64
<b>EMT345</b>	3"	720	1	5078.41
<b>EMT31245</b>	3-1/2"	1,080	1	6813.32
<b>EMT445</b>	4"	1,330	1	8024.55
<b>30 DEGREE ELBOWS</b>				
<b>EMT11430</b>	1-1/4"	118	20	823.90
<b>EMT11230</b>	1-1/2"	158	20	958.91
<b>EMT230</b>	2"	228	10	1293.26
<b>EMT21230</b>	2-1/2"	428	1	3154.30
<b>EMT330</b>	3"	720	1	4706.22
<b>EMT31230</b>	3-1/2"	1,080	1	6813.31
<b>EMT430</b>	4"	1,330	1	8024.91

NOTICE: Due to fluctuations in the steel market, conduit prices are subject to change weekly.

### SET SCREW COUPLINGS DIECAST



Vendor Code: **BRI**

Catalog Number	Size	Carton Quantity	Price per 100 pcs.
<b>240DC</b>	1/2"	50	33.24
<b>241DC</b>	3/4"	25	50.79
<b>242DC</b>	1"	25	83.63
<b>243DC</b>	1-1/4"	10	163.20
<b>244DC</b>	1-1/2"	10	237.64
<b>245DC</b>	2"	10	316.18
<b>246DC</b>	2-1/2"	12	700.72
<b>247DC</b>	3"	12	798.64
<b>248DC</b>	3-1/2"	6	926.15
<b>249DC</b>	4"	6	1074.05

### SET SCREW CONNECTORS DIECAST



Vendor Code: **BRI**

Catalog Number	Size	Carton Quantity	Price per 100 pcs.
<b>230DC2</b>	1/2"	50	25.50
<b>231DC2</b>	3/4"	25	41.80
<b>232DC2</b>	1"	25	76.48
<b>233DC2</b>	1-1/4"	10	145.86
<b>234DC2</b>	1-1/2"	10	210.11
<b>235DC2</b>	2"	10	300.90
<b>236DC2</b>	2-1/2"	12	974.10
<b>237DC2</b>	3"	12	1018.96
<b>238DC2</b>	3-1/2"	6	1209.72
<b>239DC2</b>	4"	6	1537.13
<b>INSULATED THROAT</b>			
<b>230DCI2</b>	1/2"	50	36.71
<b>231DCI2</b>	3/4"	25	60.16
<b>232DCI2</b>	1"	25	98.94

### SET SCREW CONNECTORS EMT TO FLEX

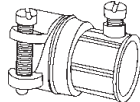

Vendor Code: **BRI**

Catalog Number	Size	Price per 100 pcs.
<b>EMT COMBINATION COUPLINGS</b>		
<b>280DC</b>	1/2" EMT to 3/8" Flex	265.20
<b>281DC</b>	1/2" EMT to 1/2" Flex	326.40
<b>282DC</b>	3/4" EMT to 3/4" Flex	366.16



### SET SCREW COUPLINGS STEEL

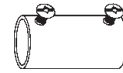

Vendor Code: **CRS**

Catalog Number	Size	Carton Quantity	Price per 100 pcs.
<b>460</b>	1/2"	50	38.90
<b>461</b>	3/4"	25	60.42
<b>462</b>	1"	20	104.75
<b>463</b>	1-1/4"	10	209.25
<b>464</b>	1-1/2"	10	303.65
<b>465</b>	2"	5	407.12
<b>466</b>	2-1/2"	2	929.97
<b>467</b>	3"	1	1049.98
<b>468</b>	3-1/2"	1	1225.78
<b>469</b>	4"	1	1401.56

### SET SCREW CONNECTORS STEEL



Vendor Code: **CRS**

Catalog Number	Size	Carton Quantity	Price per 100 pcs.
<b>445OS</b>	1/2"	50	30.16
<b>451</b>	3/4"	25	49.04
<b>452</b>	1"	20	91.66
<b>453</b>	1-1/4"	10	178.50
<b>454</b>	1-1/2"	10	257.50
<b>455</b>	2"	5	369.15
<b>456</b>	2-1/2"	2	1260.96
<b>457</b>	3"	1	1504.72
<b>458</b>	3-1/2"	1	1971.54
<b>459</b>	4"	1	2263.59
<b>INSULATED THROAT</b>			
<b>1450</b>	1/2"	50	42.28
<b>1451</b>	3/4"	25	66.31
<b>1452</b>	1"	20	112.02
<b>1453</b>	1-1/4"	10	205.77
<b>1454</b>	1-1/2"	10	308.66
<b>1455</b>	2"	5	434.42



Crouse-Hinds series



Try QuickSelect Now!  
EMT Conduit

Conduit, Fittings & Boxes



EMT CONDUIT STRAPS

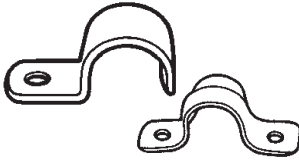

Vendor Code: **BRI**

Catalog Number	Size	Carton Quantity	Price per 100 pcs.
<b>ONE HOLE</b>			
920S	1/2"	100	16.82
921S	3/4"	100	23.46
922S	1"	50	37.78
923S	1-1/4"	100	76.47
924S	1-1/2"	100	106.06
925S	2"	50	147.90
<b>TWO HOLE</b>			
1920	1/2"	250	15.28
1921	3/4"	200	18.36
1922	1"	100	37.65
1923	1-1/4"	50	48.74
1924	1-1/2"	50	56.17
1925	2"	25	64.83

Straps for 2-1/2" and Larger Use Rigid Conduit Straps.

CLAMPBACKS  
EMT OR RIGID



Vendor Code: **CRS**

Catalog Number	Conduit Size	Carton Quantity	Price per 100 pcs.
CB1	1/2"	25	102.80
CB2	3/4"	25	117.04



Crouse-Hinds series

Try QuickSelect Now!  
EMT Fittings

DIECAST EMT



CONCRETE-TIGHT CONNECTORS

Vendor Code: **BRI**

Catalog Number	Size	Carton Quantity	Price per 100 pcs.
250DC2	1/2"	50	53.03
251DC2	3/4"	25	73.43
252DC2	1"	10	109.73
253DC2	1-1/4"	10	242.74
254DC2	1-1/2"	10	354.94
255DC2	2"	10	509.99
256DC2	2-1/2"	12	997.86
257DC2	3"	12	1265.72
258DC2	3-1/2"	6	1664.94
259DC2	4"	6	1950.24
<b>INSULATED THROAT</b>			
250DC12	1/2"	50	54.04
251DC12	3/4"	25	74.45
252DC12	1"	15	118.32
253DC12	1-1/4"	10	227.46
254DC12	1-1/2"	10	326.40
255DC12	2"	10	473.26
256DC12	2-1/2"	10	1683.00
257DC12	3"	10	1975.72
258DC12	3-1/2"	10	2880.46
259DC12	4"	6	3049.78

CONCRETE-TIGHT COUPLINGS

Vendor Code: **BRI**

Catalog Number	Size	Carton Quantity	Price per 100 pcs.
260DC	1/2"	50	64.26
261DC	3/4"	25	88.74
262DC	1"	15	147.88
263DC	1-1/4"	10	264.17
264DC	1-1/2"	10	379.44
265DC	2"	10	517.12
266DC	2-1/2"	12	1166.12
267DC	3"	12	1624.84
268DC	3-1/2"	6	2376.59
269DC	4"	6	2742.77

RAIN-TIGHT CONNECTORS  
INTEGRAL GASKET

Vendor Code: **BRI**

Catalog Number	Size	Carton Quantity	Price per 100 pcs.
250RT2	1/2"	50	92.82
251RT2	3/4"	25	128.51
252RT2	1"	15	229.48
253RT2	1-1/4"	10	434.52
254RT2	1-1/2"	10	637.48
255RT2	2"	10	1030.19

RAIN-TIGHT COUPLINGS  
INTEGRAL GASKET

Vendor Code: **BRI**

Catalog Number	Size	Carton Quantity	Price per 100 pcs.
260RT	1/2"	50	104.03
261RT	3/4"	25	145.86
262RT	1"	15	257.03
263RT	1-1/4"	10	487.55
264RT	1-1/2"	10	709.91
265RT	2"	10	1156.68

STEEL EMT



CONCRETE-TIGHT CONNECTORS

Vendor Code: **CRS**

Catalog Number	Size	Carton Quantity	Price per 100 pcs.
650S	1/2"	50	57.64
651S	3/4"	25	79.46
652	1"	25	137.62
653	1-1/4"	10	267.71
654	1-1/2"	10	391.38
655	2"	5	564.56
656	2-1/2"	2	2009.12
657	3"	1	2763.38
658	3-1/2"	1	4173.79
659	4"	1	4265.76
<b>INSULATED THROAT</b>			
1650	1/2"	50	86.79
1651	3/4"	25	120.68
1652	1"	25	190.22
1653	1-1/4"	10	387.34
1654	1-1/2"	10	567.96
1655	2"	5	826.75

CONCRETE-TIGHT COUPLINGS

Vendor Code: **CRS**

Catalog Number	Size	Carton Quantity	Price per 100 pcs.
660S	1/2"	50	69.42
661S	3/4"	25	96.52
662	1"	25	146.62
663	1-1/4"	10	291.90
664	1-1/2"	10	424.95
665	2"	5	578.14
666	2-1/2"	2	2507.34
667	3"	1	3129.76
668	3-1/2"	1	4898.17
669	4"	1	5005.47

RAIN-TIGHT CONNECTORS  
INTEGRAL GASKET

Vendor Code: **CRS**

Catalog Number	Size	Carton Quantity	Price per 100 pcs.
650RT	1/2"	50	110.16
651RT	3/4"	25	151.90
652RT	1"	25	269.23
653RT	1-1/4"	10	510.74
654RT	1-1/2"	10	747.11
655RT	2"	5	1078.17

RAIN-TIGHT COUPLINGS  
INTEGRAL GASKET

Vendor Code: **CRS**

Catalog Number	Size	Carton Quantity	Price per 100 pcs.
660RT	1/2"	50	132.76
661RT	3/4"	25	184.36
662RT	1"	25	311.07
663RT	1-1/4"	10	557.12
664RT	1-1/2"	10	811.54
665RT	2"	5	1103.96

Integral Gasket Meets Code Requirements for Rain-Tight Applications

E  
Conduit, Fittings & Boxes





Set Screw Rigid Connectors · Set Screw Rigid Couplings · Bushings · Locknuts

SET SCREW RIGID CONNECTORS



Vendor Code: **CRS**

Catalog Number	Size	Carton Quantity	Price per 100 pcs.
150P	1/2"	50	450.31
151P	3/4"	25	630.34
152P	1"	5	972.75
153P	1-1/4"	10	1561.30
154P	1-1/2"	5	2193.78
155P	2"	2	4393.72

Above 2" EMT and Rigid Have Same O.D.

SET SCREW RIGID COUPLINGS

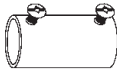

Vendor Code: **CRS**

Catalog Number	Size	Carton Quantity	Price per 100 pcs.
160	1/2"	25	654.47
161	3/4"	20	852.21
162	1"	5	1093.32
163	1-1/4"	10	1683.90
164	1-1/2"	5	2724.12
165	2"	2	4929.08

Above 2" EMT and Rigid Have Same O.D.

GROUNDING INSULATED BUSHINGS



Vendor Code: **BRI** (Bridgeport Fittings)

Catalog Number	Size	Carton Quantity	Price per 100 pcs.
<b>DIECAST</b>			
381DC	1/2"	50	392.70
382DC	3/4"	50	407.99
383DC	1"	25	448.80
384DC	1-1/4"	20	591.59
385DC	1-1/2"	20	642.59
386DC	2"	10	805.79
387DC	2-1/2"	25	1326.00
388DC	3"	25	1733.99
389DC	3-1/2"	25	1886.99
390DC	4"	20	2346.00

Vendor Code: **CRS** (Eaton Crouse-Hinds Series)

Catalog Number	Size	Carton Quantity	Price per 100 pcs.
<b>MALLEABLE</b>			
GLL1	1/2"	50	519.28
GLL2	3/4"	50	657.60
GLL3	1"	50	743.36
GLL4	1-1/4"	25	1034.87
GLL5	1-1/2"	10	1123.18
GLL6	2"	10	1496.90
GLL7	2-1/2"	10	2489.53
GLL8	3"	5	3262.76
GLL9	3-1/2"	1	3890.19
GLL10	4"	1	5128.01

PLASTIC BUSHINGS



Vendor Code: **BRI**

Catalog Number	Size	Carton Quantity	Price per 100 pcs.
321	1/2"	100	12.53
322	3/4"	100	17.23
323	1"	50	25.99
324	1-1/4"	100	36.50
325	1-1/2"	100	42.10
326	2"	50	54.57
327	2-1/2"	25	85.67
328	3"	25	101.27
329	3-1/2"	25	158.10
330	4"	20	177.98

CONDUIT LOCKNUTS



Vendor Code: **BRI**

Catalog Number	Size	Carton Quantity	Price per 100 pcs.
101S	1/2"	100	19.36
102S	3/4"	100	25.49
103S	1"	100	43.85
104S	1-1/4"	100	63.24
105S	1-1/2"	100	68.33
106S	2"	50	124.44
107S	2-1/2"	25	316.20
108S	3"	25	345.76
109S	3-1/2"	25	563.03
110S	4"	25	644.64

SEALING LOCKNUTS



Vendor Code: **CRS**

Catalog Number	Size	Carton Quantity	Price per 100 pcs.
SL1	1/2"	100	162.52
SL2	3/4"	50	195.03
SL3	1"	25	238.99
SL4	1-1/4"	25	433.45
SL5	1-1/2"	25	541.78
SL6	2"	25	812.91
SL7	2-1/2"	10	1506.22
SL8	3"	10	2167.22
SL9	3-1/2"	10	2659.85
SL10	4"	5	3240.01



Try QuickSelect Now!  
IMC / Rigid Fittings

REDUCING BUSHINGS



Vendor Code: **BRI**

Catalog Number	Size	Carton Quantity	Price per 100 pcs.
1161	3/4" x 1/2"	100	99.95
1162	1" x 1/2"	100	158.10
1163	1" x 3/4"	50	163.20
1164	1-1/4" x 1/2"	20	321.29
1165	1-1/4" x 3/4"	20	324.35
1166	1-1/4" x 1"	20	330.47
1167	1-1/2" x 1/2"	10	405.95
1168	1-1/2" x 3/4"	10	412.07
1169	1-1/2" x 1"	10	418.19
1170	1-1/2" x 1-1/4"	10	425.33
1171	2" x 1/2"	10	846.60
1172	2" x 3/4"	10	856.80
1173	2" x 1"	10	864.96
1174	2" x 1-1/4"	10	873.12
1175	2" x 1-1/2"	10	883.32
1176	2-1/2" x 2"	5	1572.83
1179	3" x 2-1/2"	5	3037.54
1182	3-1/2" x 3"	5	5378.45
1185	4" x 3-1/2"	5	5985.35



## KNOCKOUT SEALS



Vendor Code: **BRI**

Catalog Number	Size	Carton Quantity	Price per 100 pcs.
1691	1/2"	100	56.59
1692	3/4"	100	70.87
1693	1"	50	123.40
1694	1-1/4"	50	145.85
1695	1-1/2"	50	199.73
1696	2"	25	244.87

## REDUCING WASHERS



Vendor Code: **BRI**

Catalog Number	Size	Carton Quantity	Price per 100 pcs.
1061	3/4" x 1/2"	250	27.52
1062	1" x 1/2"	250	37.72
1063	1" x 3/4"	250	38.74
1064	1-1/4" x 1/2"	100	73.42
1065	1-1/4" x 3/4"	100	74.44
1066	1-1/4" x 1"	100	75.46
1067	1-1/2" x 1/2"	100	85.66
1068	1-1/2" x 3/4"	100	86.68
1069	1-1/2" x 1"	100	87.70
1070	1-1/2" x 1-1/4"	100	88.72
1071	2" x 1/2"	50	99.96
1072	2" x 3/4"	50	100.98
1073	2" x 1"	50	102.00
1074	2" x 1-1/4"	50	103.02
1075	2" x 1-1/2"	50	104.04
1078	2-1/2" x 1"	50	184.61
1079	2-1/2" x 1-1/4"	50	185.63
1080	2-1/2" x 1-1/2"	50	186.65
1081	2-1/2" x 2"	50	187.67
1086	3" x 1-1/2"	25	283.55
1087	3" x 2"	25	286.61
1088	3" x 2-1/2"	25	288.65
10896	3-1/2" x 2"	10	932.26
10898	3-1/2" x 3"	10	938.38
10906	4" x 2"	10	1107.72
10908	4" x 3"	10	1112.82

Requires Two Per Application

## EMT TO RIGID COUPLINGS

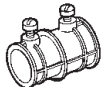

Vendor Code: **BRI**

Catalog Number	Size	Carton Quantity	Price per 100 pcs.
290DC	1/2"	100	217.26
291DC	3/4"	100	350.87
292DC	1"	50	481.44

## GALVANIZED CONDUIT NIPPLES



Vendor Code: **ROB**

Catalog Number	Pipe Size	Close Length	Price per 100 pcs.
<b>CLOSE LENGTH NIPPLES</b>			
12XC	1/2"	1-1/8"	97.27
34XC	3/4"	1-3/8"	125.06
1XC	1"	1-1/2"	208.42
114XC	1-1/4"	1-5/8"	269.08
112XC	1-1/2"	1-3/4"	324.68
2XC	2"	2"	397.99
212XC	2-1/2"	2-1/2"	1238.09
3XC	3"	2-5/8"	1446.52
312XC	3-1/2"	2-3/4"	1785.12
4XC	4"	2-7/8"	2099.70

Vendor Code: **ROB**

Catalog Number	Length	Price per 100 pcs.	Catalog Number	Length	Price per 100 pcs.
<b>1/2" PIPE SIZE</b>			<b>3/4" PIPE SIZE</b>		
12X2	2"	128.66	34X2	2"	147.79
12X3	3"	151.59	34X3	3"	179.39
12X4	4"	180.65	34X4	4"	212.23
12X6	6"	240.02	34X6	6"	284.26
12X7	7"	430.92	34X7	7"	483.99
12X8	8"	424.47	34X8	8"	486.37
12X10	10"	530.58	34X10	10"	563.44
12X12	12"	612.73	34X12	12"	631.67
<b>1" PIPE SIZE</b>			<b>1-1/4" PIPE SIZE</b>		
1X2	2"	207.19	114X2	2"	264.04
1X3	3"	250.12	114X3	3"	310.79
1X4	4"	303.18	114X4	4"	373.96
1X6	6"	377.74	114X6	6"	530.59
1X7	7"	614.16	114X7	7"	898.93
1X8	8"	627.91	114X8	8"	890.68
1X10	10"	758.00	114X10	10"	1096.56
1X12	12"	859.07	114X12	12"	1279.78
<b>1-1/2" PIPE SIZE</b>			<b>2" PIPE SIZE</b>		
112X2	2"	312.04	-	-	-
112X3	3"	377.73	2X3	3"	492.71
112X4	4"	471.22	2X4	4"	619.02
112X6	6"	649.37	2X6	6"	826.26
112X7	7"	1029.11	2X7	7"	1230.10
112X8	8"	1086.50	2X8	8"	1206.49
112X10	10"	1313.87	2X10	10"	1427.59
112X12	12"	1421.27	2X12	12"	1627.20
<b>2-1/2" PIPE SIZE</b>			<b>3" PIPE SIZE</b>		
212X4	4"	1231.77	3X4	4"	1663.85
212X6	6"	1654.98	3X6	6"	2210.87
212X7	7"	2500.18	3X7	7"	2528.76
212X8	8"	2463.56	3X8	8"	2579.87
212X10	10"	2817.31	3X10	10"	3398.43
212X12	12"	3272.10	3X12	12"	3966.97
<b>3-1/2" PIPE SIZE</b>			<b>4" PIPE SIZE</b>		
312X4	4"	2039.35	4X4	4"	2274.08
312X6	6"	2639.92	4X6	6"	2981.52
312X8	8"	3307.90	4X7	7"	3783.52
312X10	10"	4001.33	4X8	8"	3802.75
312X12	12"	4676.68	4X10	10"	4762.87
			4X12	12"	5445.08

## OFFSET NIPPLES

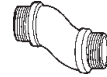

Vendor Code: **BRI**

Catalog Number	Size	Carton Quantity	Price per 100 pcs.
1520DC	1/2"	25	227.46
1521DC	3/4"	25	258.06
1522DC	1"	10	391.66
1523DC	1-1/4"	10	502.85
1524DC	1-1/2"	5	642.59
1525DC	2"	5	931.26

## DIECAST CHASE NIPPLES



Vendor Code: **BRI**

Catalog Number	Size	Carton Quantity	Price per 100 pcs.
1102DC	1/2"	100	50.99
1103DC	3/4"	100	69.76
1104DC	1"	25	187.68
1105DC	1-1/4"	25	323.33
1106DC	1-1/2"	10	434.50
1107DC	2"	5	730.31
1108DC	2-1/2"	5	1009.78
1109DC	3"	2	1387.20
1110DC	3-1/2"	2	2429.98
1111DC	4"	2	3198.65

## PULL ELBOWS



Vendor Code: **BRI**

Catalog Number	Size	Carton Quantity	Price per 100 pcs.
81DC	1/2"	10	637.50
82DC	3/4"	5	734.39
83DC	1"	5	1598.34
84DC	1-1/4"	5	2162.39

## SERVICE ENTRANCE ELBOWS

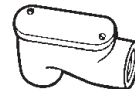

Vendor Code: **BRI**

Catalog Number	Size	Carton Quantity	Price per 100 pcs.
1025	1/2"	5	662.98
1026	3/4"	5	775.18
1027	1"	20	1254.59
1028	1-1/4"	10	1621.79
1029	1-1/2"	5	3804.59
1030	2"	4	5344.79

E Conduit, Fittings & Boxes



PVC Products (Conduit · Reducers · Elbows · End Caps · Cement and Primer)

PVC CONDUIT



Vendor Code: **PVC**

Catalog Number	Size	Lbs. per 100'	Ft. per Bundle	Price per 100 feet
<b>SCHEDULE 40</b>				
PVC12	1/2"	16	100	18.85
PVC34	3/4"	22	100	22.65
PVC1	1"	32	100	33.05
PVC114	1-1/4"	43	50	47.59
PVC112	1-1/2"	52	50	55.19
PVC2	2"	70	10	68.80
PVC212	2-1/2"	110	10	116.13
PVC3	3"	145	10	141.83
PVC312	3-1/2"	174	10	180.03
PVC4	4"	207	10	195.39
PVC5	5"	280	10	276.22
PVC6	6"	363	10	361.26
<b>SCHEDULE 80</b>				
80PVC12	1/2"	20	100	28.83
80PVC34	3/4"	28	100	39.34
80PVC1	1"	41	100	53.86
80PVC114	1-1/4"	57	50	71.06
80PVC112	1-1/2"	69	50	84.47
80PVC2	2"	95	10	109.37
80PVC212	2-1/2"	146	10	174.78
80PVC3	3"	195	10	210.66
80PVC312	3-1/2"	267	10	312.30
80PVC4	4"	286	10	322.99
80PVC5	5"	397	10	471.92
80PVC6	6"	546	10	666.51

Conduit Fill Tables: **Pages L9-L10**

PVC REDUCERS



Vendor Code: **PVF**

Catalog Number	Size	Carton Quantity	Price per 100 pcs.
5142220	3/4" x 1/2"	100	126.93
5142221	1" x 3/4"	100	292.58
5142222	1-1/4" x 1"	50	380.90
5142223	1-1/2" x 1-1/4"	50	393.59
5142224	2" x 1-1/2"	50	472.51
5142225	2-1/2" x 2"	50	1557.33
5142104	3" x 2"	25	1842.20
5142226	3" x 2-1/2"	25	1875.82
5142227	4" x 3"	25	2082.10

SCH 40 PVC ELBOWS



Vendor Code: **PVF**

Catalog Number	Size	Carton Quantity	Price per 100 pcs.
<b>90 DEGREE</b>			
12ELL90	1/2"	50	69.41
34ELL90	3/4"	25	79.80
1ELL90	1"	25	124.43
114ELL90	1-1/4"	20	189.74
112ELL90	1-1/2"	25	244.69
2ELL90	2"	20	339.95
212ELL90	2-1/2"	10	626.10
3ELL90	3"	5	1018.99
312ELL90	3-1/2"	1	1519.09
4ELL90	4"	1	1725.13
<b>45 DEGREE</b>			
12ELL45	1/2"	50	67.64
34ELL45	3/4"	25	73.23
1ELL45	1"	20	116.53
114ELL45	1-1/4"	20	166.33
112ELL45	1-1/2"	20	230.92
2ELL45	2"	20	308.46
212ELL45	2-1/2"	5	659.67
3ELL45	3"	5	958.31
312ELL45	3-1/2"	1	1161.10
4ELL45	4"	1	1662.80
<b>36" LONG RADIUS 90 DEGREE</b>			
Catalog Number	Size	Carton Quantity	Price Each
212ELL9036	2-1/2"	1	34.95
3ELL9036	3"	1	35.32
4ELL9036	4"	1	35.54

5" & 6", 24" & 48" Radius Also Available

END CAPS

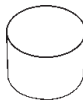

Vendor Code: **PVF**

Catalog Number	Size	Carton Quantity	Price per 100 pcs.
5140037	2"	25	506.15
5140039	3"	10	978.00
5140040	4"	5	2037.84

PVC FITTINGS CONNECTORS

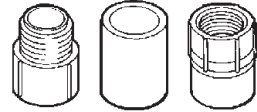

Threaded Adapters    Couplings    Female Adapters

Vendor Code: **PVF**

Catalog Number	Size	Carton Quantity	Price per 100 pcs.
<b>THREADED ADAPTERS</b>			
TA12	1/2"	150	23.41
TA34	3/4"	125	41.44
TA1	1"	50	52.26
TA114	1-1/4"	50	67.23
TA112	1-1/2"	25	81.07
TA2	2"	50	116.52
TA212	2-1/2"	25	198.11
TA3	3"	45	290.24
TA312	3-1/2"	30	374.64
TA4	4"	20	498.18
<b>COUPLINGS</b>			
CPL12	1/2"	150	17.60
CPL34	3/4"	100	21.73
CPL1	1"	50	33.46
CPL114	1-1/4"	30	44.61
CPL112	1-1/2"	25	62.38
CPL2	2"	30	81.04
CPL212	2-1/2"	20	142.66
CPL3	3"	25	235.97
CPL312	3-1/2"	20	261.01
CPL4	4"	15	364.00
<b>FEMALE ADAPTERS</b>			
FA12	1/2"	150	33.96
FA34	3/4"	100	44.13
FA1	1"	50	59.66
FA114	1-1/4"	30	79.83
FA112	1-1/2"	25	84.87
FA2	2"	30	116.03
FA212	2-1/2"	20	256.54
FA3	3"	25	320.16
FA312	3-1/2"	20	418.75
FA4	4"	15	429.24

5" & 6" Available

PVC CEMENT & PRIMER



PVC GLUE

Vendor Code: **REC**

Catalog Number	Color	Size	Carton Quantity	Price Each
<b>CEMENT</b>				
55983	Clear	Pint	12	11.30
55985	Clear	Quart	12	15.43
55986	Clear	Gallon	4	60.75
<b>PRIMER</b>				
55914	Purple	Pint	12	11.32
55918	Purple	Quart	12	15.93
55932	Clear	Pint	12	10.29
55934	Clear	Quart	12	15.43

NOTICE: Due to fluctuations in the market, PVC prices are subject to change weekly.

E  
Conduit, Fittings & Boxes



## PVC Products (Condulets · Weatherheads · FS Boxes · Cutters · Junction Boxes)

### PVC CONDULETS



Type "LB"

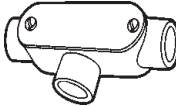

Type "T"



Type "C"

Vendor Code: **PVF**

Catalog Number	Size	Carton Quantity	Price per 100 pcs.
----------------	------	-----------------	--------------------

#### TYPE "LB" CONDULETS

<b>LB12</b>	1/2"	10	289.80
<b>LB34</b>	3/4"	10	371.90
<b>LB1</b>	1"	10	409.41
<b>LB114</b>	1-1/4"	10	622.33
<b>LB112</b>	1-1/2"	10	748.50
<b>LB2</b>	2"	10	811.19
<b>LB212</b>	2-1/2"	5	5237.17
<b>LB3</b>	3"	5	5410.98
<b>LB312</b>	3'-1/2"	5	5800.42
<b>LB4</b>	4"	5	5935.91

#### TYPE "T" CONDULETS

<b>T12</b>	1/2"	10	373.80
<b>T34</b>	3/4"	10	457.72
<b>T1</b>	1"	10	477.04
<b>T114</b>	1-1/4"	10	777.26
<b>T112</b>	1-1/2"	10	1126.02
<b>T2</b>	2"	10	1453.99

#### TYPE "C" CONDULETS

<b>C12</b>	1/2"	10	294.96
<b>C34</b>	3/4"	10	438.31
<b>C1</b>	1"	10	476.27
<b>C114</b>	1-1/4"	10	710.18
<b>C112</b>	1-1/2"	10	761.72
<b>C2</b>	2"	10	1347.82

### PVC WEATHERHEADS

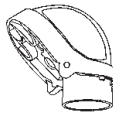

Vendor Code: **PVF**

Catalog Number	Size	Carton Quantity	Price per 100 pcs.
<b>5133742</b>	1-1/4"	5	883.67
<b>5133695</b>	1-1/2"	5	1067.16
<b>5133743</b>	2"	5	1776.95
<b>5133697</b>	3"	2	8192.35
<b>5133699</b>	4"	2	21926.96

### UNDERGROUND DUCT SPACERS

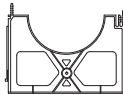

Base Spacers



Intermediate Spacers

Vendor Code: **PVF**

Catalog Number	Conduit Size	Spacing Distance	Price per 100 pcs.
----------------	--------------	------------------	--------------------

#### BASE SPACERS

<b>5335964</b>	3"	2"	182.48
<b>5335967</b>	4"	2"	182.48

#### INTERMEDIATE SPACERS

<b>5336020</b>	3"	2"	198.35
<b>5336019</b>	4"	2"	198.35

### PVC "FS" BOXES

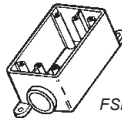

FSE

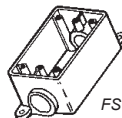

FSC

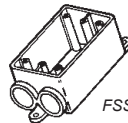

FSS

Vendor Code: **PVF**

Catalog Number	Outlet Size	Price per 100 pcs.
----------------	-------------	--------------------

#### FSE TYPE: 1 OUTLET IN ONE END

<b>5133363</b>	1/2"	847.15
<b>5133364</b>	3/4"	890.25

#### FSC TYPE: 1 OUTLET IN EACH END

<b>5133463</b>	1/2"	890.27
<b>5133464</b>	3/4"	973.53
<b>5133465</b>	1"	1119.78

#### FSS TYPE: 2 OUTLETS IN ONE END

<b>5133542</b>	3/4"	973.53
----------------	------	--------

### PVC "FS" BOX COVERS

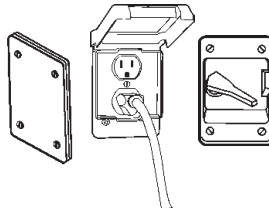

Vendor Code: **PVF**

Catalog Number	Type Opening	Price per 100 pcs.
----------------	--------------	--------------------

<b>5133362</b>	Blank Cover	796.04
<b>5133352</b>	Duplex Cover	2989.32
<b>5133330</b>	Switch Cover	1178.18

### PVC UL END BELLS



Vendor Code: **PVF**

Catalog Number	Size	Carton Quantity	Price per 100 pcs.
<b>5144008</b>	2"	40	655.01
<b>5144010</b>	3"	50	763.67
<b>5144012</b>	4"	30	908.67

### PVC CUTTERS



Vendor Code: **DOT**

Catalog Number	Description	Price Each
<b>KPVC</b>	Ratcheting Cutter 1/2" - 1"	25.70

### PVC JUNCTION BOXES



Vendor Code: **PVF**

Catalog Number	Dimensions (Height x Width x Depth)	Price per 100 pcs.
----------------	-------------------------------------	--------------------

<b>5133709</b>	4" x 4" x 4"	1320.07
<b>5133710</b>	6" x 6" x 4"	1727.61
<b>5133711</b>	6" x 6" x 6"	1885.71
<b>5133712</b>	8" x 8" x 4"	2947.21
<b>5133713</b>	12" x 12" x 6"	4643.55

### PVC PIPE STRAPS



Vendor Code: **PVF**

Catalog Number	Size	Carton Quantity	Price per 100 pcs.
----------------	------	-----------------	--------------------

<b>5133736</b>	1/2"	300	46.31
<b>5133737</b>	3/4"	200	54.84

Try QuickSelect Now!  
PVC Fittings



E

Conduit, Fittings & Boxes

"GREENFIELD" FLEXIBLE CONDUIT



Vendor Code: ALF

Catalog Number	Size	Ft. per Coil	Rigid Strap Size	Price per 100 feet
<b>ALUMINUM FLEXIBLE CONDUIT</b>				
ALF38	3/8"	100	-	37.69
ALF12	1/2"	100	1/2"	43.67
ALF34	3/4"	100	3/4"	60.04
ALF1	1"	50	1"	113.15
ALF114	1-1/4"	50	1-1/4"	157.44
ALF112	1-1/2"	25	1-1/2"	225.47
ALF2	2"	25	2"	306.01
ALF212	2-1/2"	25	2-1/2"	393.71
ALF3	3"	25	3"	643.43
ALF312	3-1/2"	25	3-1/2"	742.62
ALF4	4"	25	4"	827.02
<b>STEEL FLEXIBLE CONDUIT</b>				
SGF38	3/8"	100	-	51.88
SGF12	1/2"	100	1/2"	58.99
SGF34	3/4"	100	3/4"	79.60
SGF1	1"	50	1"	145.00
SGF114	1-1/4"	50	1-1/4"	191.20
SGF112	1-1/2"	25	1-1/2"	305.63
SGF2	2"	25	2"	373.88

\*Use Rigid Conduit Straps Listed on Page E5.

FLEX SPLITTER

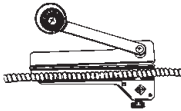

Vendor Code: IDE

Catalog Number	Size	Price Each
35782	Flex Splitter	53.18
35781	Replacement Blades	43.00

SCREW-ON FLEX FITTINGS

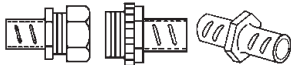

Vendor Code: BRI

Catalog Number	Size	Carton Quantity	Price per 100 pcs.
<b>SCREW IN TYPE CONNECTORS</b>			
519DC2	3/8"	100	66.28
520DC2	1/2"	100	68.34
521DC2	3/4"	50	206.04
522DC2	1"	25	348.83
<b>SCREW-IN DIE CAST COUPLINGS</b>			
530DC	1/2"	50	135.65
531DC	3/4"	50	221.34
<b>EMT TO FLEX COUPLINGS</b>			
581DC	1/2"	50	270.28
582DC	3/4"	25	382.49
583DC	1"	10	535.53
<b>STRAPS FOR FLEX</b>			
900F	3/8"	100	13.24

Use Equivalent Rigid Straps for Sealight.

STRAIGHT FLEX CONNECTORS



Squeeze Set Screw

Vendor Code: BRI

Catalog Number	Size	Carton Quantity	Price per 100 pcs.
<b>DIE CAST SQUEEZE TYPE</b>			
403DC2	3/8"	50	58.13
407DC2	1/2"	50	75.47
408DC2	3/4"	25	127.48
410DC2	1"	10	300.90
412DC2	1-1/4"	10	474.29
414DC2	1-1/2"	5	584.45
416DC2	2"	10	808.85
417DC2	2-1/2"	5	2672.39
418DC2	3"	5	3742.37
419DC2	3-1/2"	5	12346.08
420DC2	4"	5	15214.31
<b>MALLEABLE SQUEEZE TYPE</b>			
407	1/2"	50	173.39
408	3/4"	25	229.48
410	1"	10	546.70
412	1-1/4"	25	673.19
414	1-1/2"	10	992.44
416	2"	5	1491.24
417	2-1/2"	5	2527.55
418	3"	5	3631.18
419	3-1/2"	5	11795.26
420	4"	5	14035.19
<b>DIE CAST SET SCREW TYPE</b>			
501DC2	3/8"	50	36.72
507DC2	1/2"	50	80.57
508DC2	3/4"	25	189.12

90° FLEX CONNECTORS

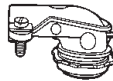

Vendor Code: BRI

Catalog Number	Size	Carton Quantity	Price per 100 pcs.
<b>DIE CAST SQUEEZE TYPE</b>			
801DC2	3/8"	25	112.19
804DC2	1/2"	25	152.98
806DC2	3/4"	10	407.98
807DC2	1"	25	859.33
808DC2	1-1/4"	25	1313.75
809DC2	1-1/2"	5	2542.84
810DC2	2"	5	2820.28
<b>MALLEABLE SQUEEZE TYPE</b>			
804	1/2"	100	353.92
806	3/4"	50	534.47
807	1"	25	960.84
808	1-1/4"	25	1359.65
809	1-1/2"	5	2584.67
810	2"	5	3233.39
811	2-1/2"	5	9128.99
812	3"	5	12260.38
813	3-1/2"	1	26581.20
814	4"	1	56334.59

ENT (ELECTRICAL NON-METALLIC TUBING)



Vendor Code: PVF

Catalog Number	Size	Feet per Coil	Price per 100 feet
ENT12BOX	1/2"	200	100.40
ENT34BOX	3/4"	100	140.59

Available in Sticks, Hand Coils and Reels.

ENT FITTINGS



Vendor Code: PVF

Catalog Number	Size	Carton Quantity	Price per 100 pcs.
<b>CONNECTORS</b>			
5163405	1/2"	150	128.41
5163406	3/4"	100	236.15
<b>COUPLINGS</b>			
5163380	1/2"	150	137.57
5163381	3/4"	100	178.83



Try QuickSelect Now!  
Flexible Fittings

Conduit, Fittings & Boxes



## Liquid-Tight Connectors · Liquid-Tight Conduit

### NON-METALLIC LIQUID-TIGHT CONDUIT

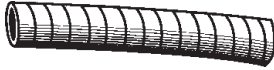

Vendor Code: **SPX**

Catalog Number	Size	Feet per Coil	Price per 100 feet
8430	3/8"	100	58.95
8431	1/2"	100	61.16
8432	3/4"	100	61.08
8433	1"	100	152.04
8434	1-1/4"	50	192.63
8435	1-1/2"	50	256.78
8436	2"	50	331.68

### NON-METALLIC LIQUID-TIGHT CONNECTORS

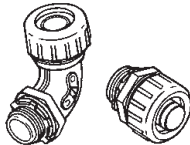

Vendor Code: **SPX**

Catalog Number	Size	Carton Quantity	Price per 100 pcs.
<b>STRAIGHT CONNECTORS</b>			
8401	3/8"	100	170.08
8403	1/2"	100	176.84
8405	3/4"	50	274.52
8407	1"	50	434.51
8409	1-1/4"	25	632.77
8411	1-1/2"	10	749.14
8413	2"	2	1181.26
<b>90 DEGREE CONNECTORS</b>			
8416	3/8"	50	246.57
8418	1/2"	50	248.91
8420	3/4"	10	358.98
8422	1"	25	828.53
8424	1-1/4"	5	965.52
8426	1-1/2"	10	1181.26
8428	2"	2	1723.38



### METALLIC LIQUID-TIGHT CONDUIT



Vendor Code: **ALF**

Catalog Number	Size	Feet per Coil	Price per 100 Feet
<b>TYPE L. T., NON-GROUNDED</b>			
LT38	3/8"	100	79.04
LT12	1/2"	100	90.85
LT34	3/4"	100	117.19
LT1	1"	100	191.50
LT114	1-1/4"	50	248.04
LT112	1-1/2"	50	468.77
LT2	2"	25	487.29
LT212	2-1/2"	25	909.31
LT3	3"	25	1395.64
LT4	4"	25	2257.58
<b>TYPE UA, BONDED</b>			
UAG38	3/8"	100	112.86
UAG12	1/2"	100	150.99
UAG34	3/4"	100	202.62
UAG1	1"	100	405.06
UAG114	1-1/4"	50	526.17
UAG112	1-1/2"	50	498.63
UAG2	2"	25	602.54

### DIECAST LIQUID-TIGHT CONNECTORS



Straight

90 Degree

Vendor Code: **BRI**

Catalog Number	Size	Carton Quantity	Price per 100 pcs.
<b>STRAIGHT</b>			
429LT2	3/8"	25	240.70
430LT2	1/2"	25	244.78
431LT2	3/4"	10	367.19
432LT2	1"	5	689.51
433LT2	1-1/4"	5	1096.48
434LT2	1-1/2"	2	1892.08
435LT2	2"	2	2554.08
436LT2	2-1/2"	1	9687.96
437LT2	3"	1	11219.99
439LT2	4"	1	14055.59
<b>90 DEGREE</b>			
469LT2	3/8"	25	383.51
470LT2	1/2"	25	400.84
471LT2	3/4"	10	557.92
472LT2	1"	5	1224.00
473LT2	1-1/4"	5	1951.26
474LT2	1-1/2"	2	2712.16
475LT2	2"	5	4303.37
476LT2	2-1/2"	1	12839.74
477LT2	3"	1	15539.69
479LT2	4"	1	19709.44

### STEEL LIQUID-TIGHT 45° AND 90° CONNECTORS

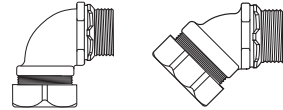

90 Degree

45 Degree

Vendor Code: **CRS**

Catalog Number	Size	Carton Quantity	Price per 100 pcs.
<b>90 DEGREE</b>			
LT3890	3/8"	25	541.80
LT5090	1/2"	25	725.01
LT7590	3/4"	10	1185.07
LT10090	1"	10	2023.82
LT12590	1-1/4"	5	3088.30
LT15090	1-1/2"	2	3966.03
LT20090	2"	1	4952.10
<b>45 DEGREE</b>			
LT5045	1/2"	25	595.99
LT7545	3/4"	10	975.24
LT10045	1"	10	1625.43

### STEEL LIQUID-TIGHT STRAIGHT CONNECTORS

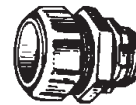

Vendor Code: **TAB** (ABB Installation Products)

Catalog Number	Size	Carton Quantity	Price per 100 pcs.
5231	3/8"	25	435.38
5232	1/2"	25	457.07
5233	3/4"	25	636.97
5234TB	1"	10	947.95
5235	1-1/4"	5	2023.28
5236	1-1/2"	2	2773.18
5237	2"	5	5118.25
5238	2-1/2"	5	21684.24
5239	3"	5	25097.05
5240	4"	1	28983.87

Vendor Code: **CRS** (Eaton Crouse-Hinds Series)

Catalog Number	Size	Carton Quantity	Price per 100 pcs.
LT38	3/8"	25	357.58
LT50	1/2"	25	447.60
LT75	3/4"	25	557.87
LT100	1"	5	945.37
LT125	1-1/4"	5	1625.40
LT150	1-1/2"	2	2167.21
LT200	2"	1	4280.30
LT250	2-1/2"	1	18269.78
LT300	3"	1	21672.32
LT400	4"	1	21672.34

E Conduit, Fittings & Boxes

"SERIES 5" CONDULETS®  
DIECAST CONTRACTOR GRADE CONDULETS

"LB" CONDULETS

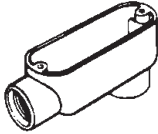

Vendor Code: **CRS**

Catalog Number	Size	Cubic Inches (in <sup>3</sup> )	Price per 100 pcs.
<b>LB15</b>	1/2"	4.35	688.17
<b>LB25</b>	3/4"	7.3	904.84
<b>LB35</b>	1"	12.2	1312.13
<b>LB45</b>	1-1/4"	32.3	2058.88
<b>LB55</b>	1-1/2"	33.8	2557.32
<b>LB65</b>	2"	71.2	3023.27
<b>LB75</b>	2-1/2"	71.2	8994.00
<b>LB85</b>	3"	183.5	10251.00
<b>LB95</b>	3-1/2"	304.9	15797.92
<b>LB105</b>	4"	308	17879.68

"C" CONDULETS

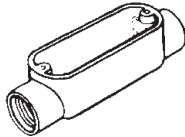

Vendor Code: **CRS**

Catalog Number	Size	Cubic Inches (in <sup>3</sup> )	Price per 100 pcs.
<b>C15</b>	1/2"	4.35	688.14
<b>C25</b>	3/4"	7.3	904.84
<b>C35</b>	1"	12.2	1312.13
<b>C45</b>	1-1/4"	32.3	2200.29
<b>C55</b>	1-1/2"	33.8	2847.92
<b>C65</b>	2"	69.5	3283.73
<b>C75</b>	2-1/2"	69.5	8433.58
<b>C85</b>	3"	188	10382.80
<b>C95</b>	3-1/2"	307	16926.34
<b>C105</b>	4"	309	19151.12

Try QuickSelect Now!  
Form 5 Condulets



"T" CONDULETS

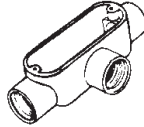

Vendor Code: **CRS**

Catalog Number	Size	Cubic Inches (in <sup>3</sup> )	Price per 100 pcs.
<b>T15</b>	1/2"	4.35	758.51
<b>T25</b>	3/4"	7.3	1051.12
<b>T35</b>	1"	12.2	1517.06
<b>T45</b>	1-1/4"	33.1	2225.04
<b>T55</b>	1-1/2"	33.1	3250.84
<b>T65</b>	2"	67	3605.55
<b>T75</b>	2-1/2"	67	10150.08
<b>T85</b>	3"	175	10942.02
<b>T95</b>	3-1/2"	298	17459.08
<b>T105</b>	4"	300	19461.32

"LL & LR" CONDULETS

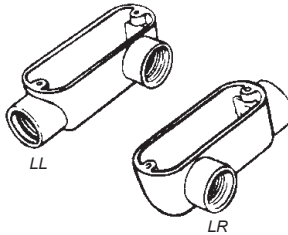

Vendor Code: **CRS**

Catalog Number	Size	Cubic Inches (in <sup>3</sup> )	Price per 100 pcs.
<b>TYPE LL</b>			
<b>LL15</b>	1/2"	4.35	541.80
<b>LL25</b>	3/4"	7.3	758.50
<b>LL35</b>	1"	12.2	1083.60
<b>LL45</b>	1-1/4"	35.8	1733.79
<b>LL55</b>	1-1/2"	35.8	2058.86
<b>LL65</b>	2"	69.7	2600.66
<b>LL75</b>	2-1/2"	69.7	7871.34
<b>LL85</b>	3"	186	9690.60
<b>LL95</b>	3-1/2"	306	16926.34
<b>LL105</b>	4"	308	17874.38
<b>TYPE LR</b>			
<b>LR15</b>	1/2"	4.35	541.80
<b>LR25</b>	3/4"	7.3	758.50
<b>LR35</b>	1"	12.2	1083.60
<b>LR45</b>	1-1/4"	35.8	1733.79
<b>LR55</b>	1-1/2"	35.8	2058.86
<b>LR65</b>	2"	69.7	2600.66
<b>LR75</b>	2-1/2"	69.7	7871.34
<b>LR85</b>	3"	186	9690.60
<b>LR95</b>	3-1/2"	306	16926.34
<b>LR105</b>	4"	308	17874.38

BLANK COVERS  
ALUMINUM

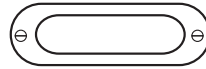

Vendor Code: **CRS**

Catalog Number	Size	Price per 100 pcs.
<b>150</b>	1/2"	150.07
<b>250</b>	3/4"	180.96
<b>350</b>	1"	264.34
<b>450</b>	1-1/4" & 1-1/2"	540.53
<b>650</b>	2"	764.34
<b>850D</b>	2-1/2" & 3"	1338.22
<b>950D</b>	3-1/2" & 4"	1788.33

NEOPRENE GASKETS



Vendor Code: **GAS**

Catalog Number	Size	Price per 100 pcs.
<b>GASK015N</b>	1/2"	146.65
<b>GASK025N</b>	3/4"	155.08
<b>GASK035N</b>	1"	226.65
<b>GASK045N</b>	1-1/4" & 1-1/2"	287.21
<b>GASK065N</b>	2"	439.99
<b>GASK085N</b>	2-1/2" & 3"	588.51
<b>GASK095N</b>	3-1/2" & 4"	754.30

INTEGRAL GASKET COVERS



Vendor Code: **CRS**

Catalog Number	Size	Unit Quantity	Price per 100 pcs.
<b>150G</b>	1/2"	50	325.08
<b>250G</b>	3/4"	50	398.56
<b>350G</b>	1"	50	639.32
<b>450G</b>	1-1/4" - 1-1/2"	50	931.90
<b>650G</b>	2"	25	1083.61
<b>850G</b>	2-1/2" - 3"	10	1756.92
<b>950G</b>	3-1/2" - 4"	10	2346.40

1/2" - 3" are NEMA 4 Rated



Crouse-Hinds series

E  
Conduit, Fittings & Boxes





### FORM 5 CONDULETS®

These condulets are interchangeable with Appleton Form 35 Conduit Bodies. These condulets feature built-in rollers on 1-1/4" to 4" C and LB bodies to facilitate wire pulling and stainless steel cover screws.

#### "LB" CONDULETS

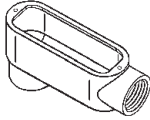

Vendor Code: **CRS**

Catalog Number	Size	Cubic Inches (in <sup>3</sup> )	Price per 100 pcs.
<b>LB50M</b>	1/2"	4.5	975.24
<b>LB75M</b>	3/4"	7.5	1191.97
<b>LB100M</b>	1"	12.5	1733.79
<b>LB125M*</b>	1-1/4"	32.0	3077.46
<b>LB150M*</b>	1-1/2"	35.3	4009.37
<b>LB200M*</b>	2"	73.0	5959.88
<b>LB250M*</b>	2-1/2"	142.0	12569.94
<b>LB300M*</b>	3"	173.0	18647.00
<b>LB350M*</b>	3-1/2"	292.0	27628.88
<b>LB400M*</b>	4"	324.0	31178.74

\*1-1/4" - 4" LB and C bodies supplied with built in rollers to facilitate wire pulling.

#### "LL" & "LR" CONDULETS

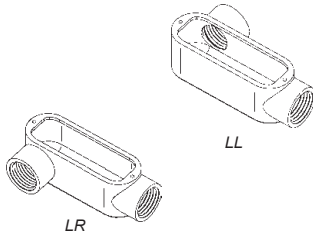

Vendor Code: **CRS**

Catalog Number	Size	Cubic Inches (in <sup>3</sup> )	Price per 100 pcs.
<b>TYPE LL</b>			
<b>LL50M</b>	1/2"	4.5	975.24
<b>LL75M</b>	3/4"	7.5	1191.97
<b>LL100M</b>	1"	12.5	1625.43
<b>LL125M</b>	1-1/4"	32.0	3067.48
<b>LL150M</b>	1-1/2"	33.0	3998.72
<b>LL200M</b>	2"	68.0	6591.70
<b>LL250M</b>	2-1/2"	142.0	13986.72
<b>LL300M</b>	3"	173.0	18647.00
<b>TYPE LR</b>			
<b>LR50M</b>	1/2"	4.5	975.24
<b>LR75M</b>	3/4"	7.5	1191.97
<b>LR100M</b>	1"	12.5	1625.43
<b>LR125M</b>	1-1/4"	32.0	3067.48
<b>LR150M</b>	1-1/2"	35.3	3998.72
<b>LR200M</b>	2"	68.0	6591.70
<b>LR250M</b>	2-1/2"	142.0	13986.72
<b>LR300M</b>	3"	173.0	18647.00

#### "T" CONDULETS

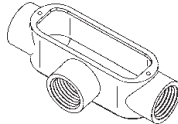

Vendor Code: **CRS**

Catalog Number	Size	Cubic Inches (in <sup>3</sup> )	Price per 100 pcs.
<b>T50M</b>	1/2"	6.0	1300.31
<b>T75M</b>	3/4"	9.5	1408.67
<b>T100M</b>	1"	15.0	2167.23
<b>T125M</b>	1-1/4"	33.0	4065.70
<b>T150M</b>	1-1/2"	36.0	4226.09
<b>T200M</b>	2"	76.0	6996.06
<b>T250M</b>	2-1/2"	142.0	13311.42
<b>T300M</b>	3"	173.0	19338.04

#### "C" CONDULETS

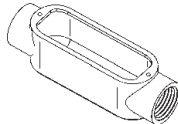

Vendor Code: **CRS**

Catalog Number	Size	Cubic Inches (in <sup>3</sup> )	Price per 100 pcs.
<b>C50M</b>	1/2"	4.5	1230.57
<b>C75M</b>	3/4"	7.5	1474.17
<b>C100M</b>	1"	12.5	2214.94
<b>C125M*</b>	1-1/4"	35.0	3467.64
<b>C150M*</b>	1-1/2"	35.3	4998.42
<b>C200M*</b>	2"	75.0	8242.11
<b>C250M*</b>	2-1/2"	153.0	12659.72
<b>C300M*</b>	3"	181.0	16876.96

\*1-1/4" - 4" LB and C bodies supplied with built in rollers to facilitate wire pulling.

#### BLANK COVERS WITH STAINLESS STEEL SCREWS



Vendor Code: **CRS**

Catalog Number	Size	Unit Quantity	Price per 100 pcs.
<b>K50S</b>	1/2"	50	303.40
<b>K75S</b>	3/4"	50	368.43
<b>K100S</b>	1"	25	400.93
<b>K125S</b>	1-1/4" & 1-1/2"	20	743.33
<b>K200S</b>	2"	5	812.69
<b>K250S</b>	2-1/2" & 3"	5	1665.68
<b>K350S</b>	3-1/2" & 4"	5	1964.92

#### NEOPRENE GASKETS



Vendor Code: **GAS**

Catalog Number	Size	Price per 100 pcs.
<b>GASK015N</b>	1/2"	146.65
<b>GASK025N</b>	3/4"	155.08
<b>GASK035N</b>	1"	226.65
<b>GASK045N</b>	1-1/4" & 1-1/2"	287.21
<b>GASK065N</b>	2"	439.99
<b>GASK085N</b>	2-1/2" & 3"	588.51
<b>GASK095N</b>	3-1/2" & 4"	754.30

Try QuickSelect Now!  
Form 5 Condulets



Crouse-Hinds series

E  
Conduit, Fittings & Boxes

FORM 7 CONDULETS®

These condulets match the conduit system for a neat, compact installation. The round backs of the condulets are ideal when used against a wall or ceiling, and the snaplight and wedge-nut covers provide a clear and unobstructed cover opening. These condulets have tapered hubs and feature integral bushings for protection of wire insulation. **Form 7 has a removable cover even in corrosive conditions.**

"LB" CONDULETS

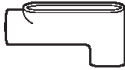

Vendor Code: **CRS**

Catalog Number	Size	Cubic Inches (in <sup>3</sup> )	Price Each
LB17	1/2"	4.0	16.53
LB27	3/4"	6.5	19.80
LB37	1"	10.5	29.88
LB47	1-1/4"	18.5	47.49
LB57	1-1/2"	26.0	61.42
LB67	2"	46.0	101.29
LB777	2-1/2"	94.0	219.84
LB87	3"	128.0	281.94
LB97	3-1/2"	216.0	475.43
LB107	4"	240.0	522.35

"T" CONDULETS

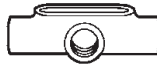

Vendor Code: **CRS**

Catalog Number	Size	Cubic Inches (in <sup>3</sup> )	Price Each
T17	1/2"	5.8	21.00
T27	3/4"	9.0	25.95
T37	1"	14.5	37.71
T47	1-1/4"	18.5	54.76
T57	1-1/2"	26.0	76.10
T67	2"	46.0	117.53

WEDGE-NUT COVERS WITH INTEGRAL GASKET



Vendor Code: **CRS**

Catalog Number	Size	Price Each
170G	1/2"	8.80
270G	3/4"	10.46
370G	1"	14.26
470G	1-1/4"	16.55
570G	1-1/2"	16.55
670G	2"	26.18

"LL" AND "LR" CONDULETS



Vendor Code: **CRS**

Catalog Number	Size	Cubic Inches (in <sup>3</sup> )	Price Each
<b>TYPE LL</b>			
LL17	1/2"	4.0	16.53
LL27	3/4"	6.5	19.80
LL37	1"	10.5	29.88
LL47	1-1/4"	18.5	47.49
LL57	1-1/2"	26.0	61.42
LL67	2"	46.0	101.29
<b>TYPE LR</b>			
LR17	1/2"	4.0	16.53
LR27	3/4"	6.5	19.80
LR37	1"	10.5	29.88
LR47	1-1/4"	18.5	47.49
LR57	1-1/2"	26.0	61.42
LR67	2"	46.0	101.29

"C" CONDULETS



Vendor Code: **CRS**

Catalog Number	Size	Cubic Inches (in <sup>3</sup> )	Price Each
C17	1/2"	4.0	16.54
C27	3/4"	6.5	19.80
C37	1"	10.5	29.88
C47	1-1/4"	18.5	47.49
C57	1-1/2"	26.0	61.40
C67	2"	46.0	101.29

WEDGE-NUT COVERS

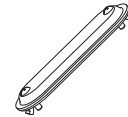

Vendor Code: **CRS**

Catalog Number	Size	Price Each
170	1/2"	5.00
270	3/4"	6.08
370	1"	8.80
470	1-1/4"	10.09
570	1-1/2"	10.09
670	2"	21.13
870	2-1/2" & 3"	32.79
970	3-1/2" & 4"	38.48

"X" CONDULETS

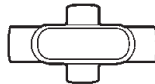

Vendor Code: **CRS**

Catalog Number	Size	Cubic Inches (in <sup>3</sup> )	Price Each
X17	1/2"	5.8	32.11
X27	3/4"	9.0	33.06
X37	1"	14.5	44.76
X47	1-1/4"	18.5	63.02
X57	1-1/2"	26.0	81.35
X67	2"	46.0	140.99

NEOPRENE GASKETS



Vendor Code: **GAS**

Catalog Number	Size	Price per 100 pcs.
GASK571	1/2"	238.63
GASK572	3/4"	353.26
GASK573	1"	439.80
GASK574	1-1/4"	462.28
GASK575	1-1/2"	497.89
GASK576	2"	518.97
GASK578	2-1/2" & 3"	801.49
GASK579	3-1/2" & 4"	859.76

**NEW** "U" CONDULETS



Vendor Code: **CRS**

Catalog Number	Size	Cubic Inches (in <sup>3</sup> )	Price Each
U17	1/2"	7.3	22.36
U27	3/4"	10.6	26.73
U37	1"	20.1	40.28
U47	1-1/4"	40.5	64.15
U57	1-1/2"	67.1	82.90
U67	2"	123.6	136.73

"TB" CONDULETS



Vendor Code: **CRS**

Catalog Number	Size	Cubic Inches (in <sup>3</sup> )	Price Each
TB17	1/2"	5.8	22.70
TB27	3/4"	9.0	28.87
TB37	1"	14.5	40.85
TB47	1-1/4"	18.5	59.23
TB57	1-1/2"	26.0	77.34
TB67	2"	46.0	121.14

Try QuickSelect Now!  
Form 7 Condulets





## CHANNELS

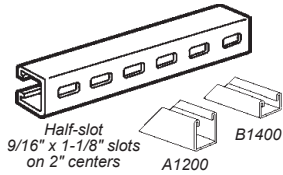

Vendor Code: **TAB**

Catalog Number	Description	Price per 100 feet
<b>12 GAUGE - 1-5/8" X 1-5/8" HALF SLOT</b>		
A1200HS10PG	Pre Galv	411.03
A1200HS10EG	Electro Galv	532.11
A1200HS10HDG	HotDip Galv	990.97
<b>12 GAUGE - 1-5/8" X 1-5/8" SOLID</b>		
A120010PG	Pre Galv	411.03
A120010EG	Electro Galv	564.03
A120010HDG	HotDip Galv	990.97
<b>14 GAUGE - 1-5/8" X 13/16" HALF SLOT</b>		
B1400HS10PG	Pre Galv	297.33
B1400HS10EG	Electro Galv	364.02
B1400HS10HDG	HotDip Galv	945.51
<b>14 GAUGE - 1-5/8" X 13/16" SOLID</b>		
B140010PG	Pre Galv	297.33
B140010EG	Electro Galv	385.83
B140010HDG	HotDip Galv	794.22

## CHANNELS

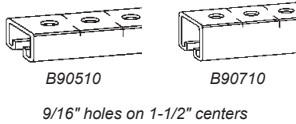

Vendor Code: **TAB**

Catalog Number	Description	Price per 100 feet
<b>14 GAUGE - 1-1/2" X 3/4" ROUND HOLES</b>		
B90710	Galv-Krom Finish	622.82
<b>12 GAUGE - 1-1/2" X 1-1/2" ROUND HOLES</b>		
B90510	Galv-Krom Finish	831.88

## SPRING CHANNEL NUTS

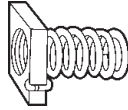

Vendor Code: **TAB**

Catalog Number	Description	Ctn. Qty.	Price per 100 pcs.
<b>FOR DEEP CHANNEL</b>			
A10014	1/4" Spring Nut	100	138.93
A10038	3/8" Sprint Nut	100	150.07
A10012	1/2" Spring Nut	100	192.04

## TWIRL CHANNEL NUTS

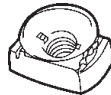

Vendor Code: **TAB**

Catalog Number	Description	Standard Package	Price per 100 pcs.
<b>FITS ALL CHANNEL DEPTHS</b>			
UCN14	1/4" Twirl Nut	100	262.08
UCN38	3/8" Twirl Nut	100	269.87
UCN12	1/2" Twirl Nut	100	277.77

## UNIVERSAL PIPE STRAPS

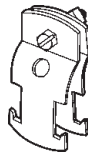

Vendor Code: **TAB**

Catalog Number	Size for IMC/ EMT/Rigid	Std. Pkg.	Load (Lbs.)	Price per 100 pcs.
<b>UNIVERSAL</b>				
70312EG	1/2"	100	400	160.65
70334EG	3/4"	100	550	169.05
7031EG	1"	100	550	193.63
703114EG	1-1/4"	50	800	243.42
703112EG	1-1/2"	50	800	284.93
7032EG	2"	50	800	291.12
702212EG	2-1/2"	50	1,000	333.85
7023EG	3"	50	1,650	358.37
702312EG	3-1/2"	25	1,650	413.95
7024EG	4"	25	1,650	465.86



## ALL-THREAD RODS

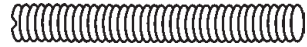

Vendor Code: **TAB**

Catalog Number	Size	Standard Package	Price per 100 Feet
<b>PLATED</b>			
R1028	1/4" x 10'	500'	42.71
R1038	3/8" x 10'	250'	83.57
R1048	1/2" x 10'	100'	135.69

## ROD COUPLINGS

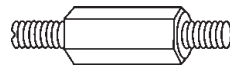

Vendor Code: **DOT**

Catalog Number	Description	Carton Quantity	Price per 100 pcs.
RC1	Nut 1/4-20	100	49.62
RC2	Nut 3/8-16	50	75.51
RC3	Nut 1/2-13	50	93.65

## ANGLE CONNECTORS

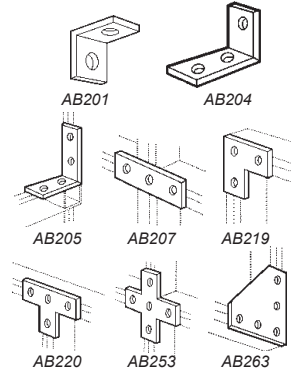

Vendor Code: **TAB**

Catalog Number	Description	Price per 100 pcs.
<b>SUPERSTRUT 90° ANGLE FITTINGS</b>		
AB201	2 Hole	439.89
AB204	3 Hole, 3-1/2"	693.89
AB205	4 Hole	847.27
<b>SUPERSTRUT FLAT PLATE FITTINGS</b>		
AB207	3 Hole	628.98
AB219	3 Hole, 90°	890.15
AB220	4 Hole "T"	1213.83
AB253	5 Hole "X"	2421.34
AB263	5 Hole, 90°	4636.38

E Conduit, Fittings & Boxes



Beam Clamps · Conduit Hangers · Spring Channel Nuts · Universal Pipe Straps

BEAM CLAMPS



Vendor Code: **BRI**

Catalog Number	Jaw Size	Tapping in Base	Ctn. Qty.	Price per 100 pcs.
951	3/4"	1/4-20	25	188.69
952	11/16"	5/16-18	50	474.36
953	7/8"	3/8-16	50	623.67
954	1-1/4"	1/2-13	25	1188.55

CONDUIT HANGERS  
RIGID OR EMT



Vendor Code: **BRI**

Catalog Number	Size		Carton Quantity	Price per 100 pcs.
	Rigid	EMT		
2100	1/2"	1/2"	100	54.05
2110	3/4"	3/4"	100	62.20
2120	1"	1"	100	73.44
2125	-	1-1/4"	50	133.60
2130	1-1/4"	1-1/2"	50	86.69
2140	1-1/2"	-	50	126.48
2150	2"	2"	50	164.21
2160	2-1/2"	2-1/2"	25	173.38
2170	3"	3"	25	248.86
2180	3-1/2"	3-1/2"	10	279.47
2190	4"	4"	10	525.28

CLAMPS

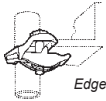

Edge

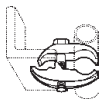

Parallel

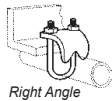

Right Angle

Vendor Code: **ROB**

Catalog Number	Size	Carton Quantity	Price per 100 pcs.
<b>RIGHT ANGLE CLAMPS</b>			
RA12	1/2"	50	299.85
RA34	3/4"	50	316.34
RA1	1"	50	345.44
RA114	1-1/4"	50	389.72
RA112	1-1/2"	50	417.57
RA2	2"	50	632.68
<b>EDGE CLAMPS</b>			
ET12	1/2"	50	594.73
ET34	3/4"	50	632.68
ET1	1"	25	727.58
<b>PARALLEL CLAMPS</b>			
PAR12	1/2"	40	436.54
PAR34	3/4"	50	474.50
PAR1	1"	50	537.77
PAR114	1-1/4"	25	614.21
PAR112	1-1/2"	25	727.55
PAR2	2"	25	949.01

CHANNELS

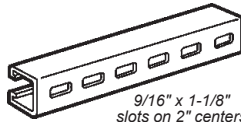

9/16" x 1-1/8" slots on 2" centers

Vendor Code: **BLI**

Catalog Number	Description	Price per 100 Feet
<b>12 GAUGE - 1-5/8" X 1-5/8" HALF SLOT</b>		
B22SH120GLV	Pre Galv	299.76
B22SH120GRN	Green	398.99
B22SH120HDG	HotDip Galv	740.94
<b>12 GAUGE - 1-5/8" X 1-5/8" SOLID</b>		
B22120GLV	Pre Galv	311.82
B22120GRN	Green	377.99
B22120HDG	HotDip Galv	740.94
<b>14 GAUGE - 1-5/8" X 13/16" HALF SLOT</b>		
B54SH120GLV	Pre Galv	234.25
B54SH120GRN	Green	293.98
B54SH120HDG	HotDip Galv	547.44
<b>14 GAUGE - 1-5/8" X 13/16" SOLID</b>		
B54120GLV	Pre Galv	225.00
B54120GRN	Green	235.74
B54120HDG	HotDip Galv	656.92

SPRING CHANNEL NUTS

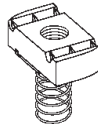

Vendor Code: **BLI**

Catalog Number	Description	Carton Quantity	Price per 100 pcs.
<b>FOR 1-5/8" CHANNEL</b>			
N224ZN	1/4" Spring Nut	100	83.58
N228ZN	3/8" Spring Nut	100	96.47
N225ZN	1/2" Spring Nut	100	86.60

TWIRL CHANNEL NUTS



Vendor Code: **BLI**

Catalog Number	Description	Carton Quantity	Price per 100 pcs.
TN224ZN	1/4" Twirl Nut	100	198.17
TN228ZN	3/8" Twirl Nut	100	218.95
TN225ZN	1/2" Twirl Nut	100	229.84

UNIVERSAL PIPE STRAPS  
1-5/8" & 1-1/2" CHANNEL

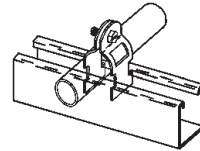

- Pre-assembled pipe clamps
- Includes Combination Recess Hex Head
- Machine Screw and Square Nut
- Standard finish: ZN

Vendor Code: **BLI**

Catalog Number	Size for IMC/EMT/Rigid	Ctn. Qty.	Load (Lbs.)	Price per 100 pcs.
B2208PA12	1/2"	100	400	106.45
B2209PA34	3/4"	100	400	115.82
B2210PA1	1"	100	400	124.22
B2211PA114	1-1/4"	100	400	134.88
B2212PA112	1-1/2"	50	600	149.16
B2213PA2	2"	50	600	173.96
B2014PA212	2-1/2"	50	800	226.70
B2015PA3	3"	50	800	253.42
B2016PA312	3-1/2"	40	1,000	318.55
B2017PA4	4"	40	1,000	359.45

ANGLE CONNECTORS

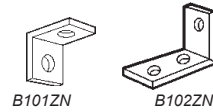

B101ZN

B102ZN

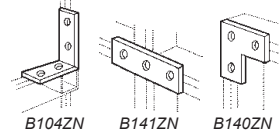

B104ZN

B141ZN

B140ZN

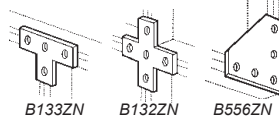

B133ZN

B132ZN

B556ZN

Vendor Code: **BLI**

Catalog Number	Description	Price per 100 pcs.
<b>SUPERSTRUT 90° ANGLE FITTINGS</b>		
B101ZN	2 Hole	287.55
B102ZN	3 Hole, 3-1/2"	489.97
B104ZN	4 Hole	374.45
<b>SUPERSTRUT FLAT PLATE FITTINGS</b>		
B140ZN	3 Hole, 90°	432.51
B141ZN	3 Hole	667.22
B133ZN	4 Hole "T"	627.38
B132ZN	5 Hole "X"	2675.41
B556ZN	5 Hole, 90°	4674.79



B-Line series

E Conduit, Fittings & Boxes



## Plasti-Bond Red PVC-Coated Rigid Steel Conduit · Couplings · Hubs · Unions

### PLASTI-BOND RED PVC-COATED RIGID STEEL CONDUIT

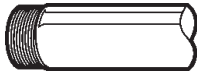

New Plasti-bond Red Coated Conduit from Robroy Industries is a completely encapsulated conduit system that provides total protection against corrosion inside and out.

- A 40 mil PVC exterior coating is permanently fused to hot dipped galvanized steel conduit.
- A tough, flexible, red urethane coating is applied to the interior of the conduit by an exclusive Robroy Industries process.
- A clear urethane coating applied over galvanized threads resists corrosion before and after installation.

Hidden internal corrosion cannot gain a foothold on Plasti-bond Red Coated Conduit. The exclusive Robroy red urethane interior coating is chemically cured, flexible, and won't chip or crack. The superior bond between the 40 mil PVC exterior coating and the galvanized steel conduit stops corrosion "undercreep".

Vendor Code: **PLB**

Catalog Number	Size	Lbs. per 100 Feet	Price per 100 Feet
<b>PB12</b>	1/2"	85	537.33
<b>PB34</b>	3/4"	112	622.76
<b>PB1</b>	1"	164	806.23
<b>PB114</b>	1-1/4"	217	1020.30
<b>PB112</b>	1-1/2"	268	1240.83
<b>PB2</b>	2"	358	1618.70
<b>PB212</b>	2-1/2"	546	2451.23
<b>PB3</b>	3"	708	3094.31
<b>PB4</b>	4"	1,009	4460.07

Available up to 6".



Try QuickSelect Now!  
Plasti-Bond Fittings

### PLASTI-BOND RED PVC-COATED RIGID STEEL ELBOWS



Vendor Code: **PLB**

Catalog Number	Size	Lbs. per 100 pcs.	Ctn. Qty.	Price per 100 pcs.
<b>12ELL90</b>	1/2"	83	25	2784.10
<b>34ELL90</b>	3/4"	120	25	2785.79
<b>1ELL90</b>	1"	208	20	3195.14
<b>114ELL90</b>	1-1/4"	330	20	39.91
<b>112ELL90</b>	1-1/2"	453	10	4824.12
<b>2ELL90</b>	2"	690	10	6846.76
<b>212ELL90</b>	2-1/2"	1,365	50	13157.44
<b>3ELL90</b>	3"	2,358	50	20998.34
<b>4ELL90</b>	4"	3,359	28	29435.27

### PLASTI-BOND RED PVC-COATED RIGID STEEL COUPLINGS



- 40 mil PVC exterior coating
- Clear urethane interior coating
- Pressure sealing sleeves
- Molded external ribs prevent tool damage
- Trade Sizes - 1/2" through 6"

Vendor Code: **PLB**

Catalog Number	Size	Lbs. per 100 pcs.	Ctn. Qty.	Price per 100 pcs.
<b>CPL12</b>	1/2"	15	50	619.34
<b>CPL34</b>	3/4"	21	50	647.97
<b>CPL1</b>	1"	36	50	842.27
<b>CPL114</b>	1-1/4"	47	50	9.80
<b>CPL112</b>	1-1/2"	64	40	1167.56
<b>CPL2</b>	2"	85	30	1707.97
<b>CPL212</b>	2-1/2"	233	9	4226.99
<b>CPL3</b>	3"	317	8	5133.46
<b>CPL4</b>	4"	434	8	7700.19

### APPLICATIONS

For Plasti-Bond Red Coated Conduit

- Chemical Plants
- Fertilizer Plants
- Offshore Oil Platforms
- Paper Mills
- Petrochemical Plants
- Steel Mills
- Food Processing Plants
- Breweries
- Water & Wastewater Treatment Plants

### PLASTI-BOND RED PVC-COATED HUBS

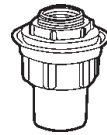

Vendor Code: **PLB**

Catalog Number	Size	Carton Quantity	Price Each
<b>ST1</b>	1/2"	40	47.26
<b>ST2</b>	3/4"	25	59.12
<b>ST3</b>	1"	15	67.11
<b>ST4</b>	1-1/4"	15	77.15
<b>ST5</b>	1-1/2"	10	88.22
<b>ST6</b>	2"	5	126.94

### PLASTI-BOND RED PVC-COATED UNIONS

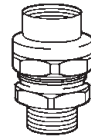

Vendor Code: **PLB**

Catalog Number	Size	Carton Quantity	Price Each
<b>UNY105</b>	1/2"	40	73.15
<b>UNY205</b>	3/4"	25	79.83
<b>UNY305</b>	1"	15	97.14
<b>UNY405</b>	1-1/4"	15	152.89
<b>UNY505</b>	1-1/2"	10	185.75
<b>UNY605</b>	2"	5	232.39

### PLASTI-BOND RED PVC-COATED CONDULETS

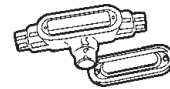

Vendor Code: **PLB**

Catalog Number	Size	Type	Price Each
<b>LB18</b>	1/2"	LB	58.96
<b>LB28</b>	3/4"	LB	65.34
<b>LB36</b>	1"	LB	87.45
<b>LB48</b>	1-1/4"	LB	126.99
<b>LB58</b>	1-1/2"	LB	155.03
<b>LB68</b>	2"	LB	228.59
<b>T18</b>	1/2"	T	68.03
<b>T28</b>	3/4"	T	85.21
<b>T38</b>	1"	T	101.82
<b>T448</b>	1-1/4"	T	143.26
<b>T58</b>	1-1/2"	T	178.97
<b>T68</b>	2"	T	259.94

**E** Conduit, Fittings & Boxes



Stainless Steel Conduit · Stainless Steel Form 8 Conduit Bodies

STAINLESS STEEL RIGID CONDUIT

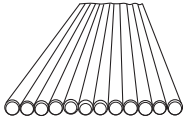

Vendor Code: **CAL**

Catalog Number	Trade Size	Weight per 100 ft.	Price per 100 ft.
<b>TYPE 304</b>			
S40510CT00	1/2"	82	790.01
S40710CT00	3/4"	109	836.01
S41010CT00	1"	161	1160.71
S41210CT00	1-1/4"	218	1764.29
S41510CT00	1-1/2"	263	1987.14
S42010CT00	2"	350	2553.57
S42510CT00	2-1/2"	559	4364.29
S43010CT00	3"	727	6000.01
S44010CT00	4"	1,008	8000.00

316 Stainless Available

ELBOWS, 90°

Vendor Code: **CAL**

Catalog Number	Trade Size	Price Each
<b>TYPE 304</b>		
S40590EL00	1/2"	15.99
S40790EL00	3/4"	20.06
S41090EL00	1"	24.92
S41290EL00	1-1/4"	45.50
S41590EL00	1-1/2"	67.17
S42090EL00	2"	97.50
S42590EL00	2-1/2"	189.58
S43090EL00	3"	270.83
S44090EL00	4"	411.66

316 Stainless Available

STAINLESS STEEL EMT CONDUIT

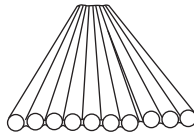

Vendor Code: **CAL**

Catalog Number	Trade Size	Weight per 100 ft.	Price per 100 ft.
<b>TYPE 304</b>			
S10510CT00	1/2"	30	440.63
S10710CT00	3/4"	50	547.86
S11010CT00	1"	68	812.50
S11210CT00	1-1/4"	100	1190.00
S11510CT00	1-1/2"	110	1370.01
S12010CT00	2"	140	2020.00

316 Stainless Available

COMPRESSION CONNECTORS

Vendor Code: **CAL**

Catalog Number	Trade Size	Price Each
<b>MALE CONNECTORS</b>		
S20500MC00	1/2"	19.63
S20700MC00	3/4"	22.96
S21000MC00	1"	27.16
S21200MC00	1-1/4"	46.86
S21500MC00	1-1/2"	57.06
S22000MC00	2"	67.98

COMPRESSION COUPLINGS

Vendor Code: **CAL**

Catalog Number	Trade Size	Price Each
<b>UNIONS</b>		
S20500CC00	1/2"	25.06
S20700CC00	3/4"	27.80
S21000CC00	1"	33.47
S21200CC00	1-1/4"	54.58
S21500CC00	1-1/2"	59.23
S22000CC00	2"	78.27

Please Note

Elliott Electric Supply can source just about any part you might need in stainless steel.

IMC and Flex conduit & fittings, nipples, compression fittings, couplings, grounding hubs, terminator hubs, strut, channels, grip connectors, device boxes, covers & plates, washers, nuts & screws, clamps, straps & hangers, and much more—just ask!

STAINLESS STEEL CONDUIT BODIES FORM 8 TYPE 316

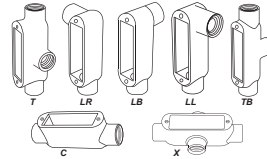

Vendor Code: **CAL**

Catalog Number	Trade Size	Cubic Inches (in <sup>3</sup> )	Price Each
<b>LB</b>			
S60500LB00	1/2"	4.0	103.30
S60700LB00	3/4"	7.0	109.99
S61000LB00	1"	11.0	125.00
S61200LB00	1-1/4"	20.0	200.86
S61500LB00	1-1/2"	35.0	208.93
S62000LB00	2"	71.0	260.00
S62500LB00	2-1/2"	157.0	510.73
S63000LB00	3"	177.0	573.85
S64000LB00	4"	380.0	860.78
<b>T</b>			
S60500TE00	1/2"	5.0	112.86
S60700TE00	3/4"	9.0	125.28
S61000TE00	1"	13.0	140.60
S61200TE00	1-1/4"	24.0	221.89
S61500TE00	1-1/2"	35.0	237.20
S62000TE00	2"	77.0	282.14
S62500TE00	2-1/2"	160.0	592.98
S63000TE00	3"	177.0	655.16
S64000TE00	4"	382.0	956.43
<b>LL</b>			
S60500LL00	1/2"	4.0	103.30
S60700LL00	3/4"	7.0	109.99
S61000LL00	1"	11.0	121.47
S61500LL00	1-1/2"	35.0	215.20
S62000LL00	2"	71.0	267.80
<b>LR</b>			
S60500LR00	1/2"	4.0	103.30
S60700LR00	3/4"	7.0	109.99
S61000LR00	1"	11.0	121.47
S61500LR00	1-1/2"	35.0	215.20
S62000LR00	2"	71.0	267.80
<b>TB</b>			
S60500TB00	1/2"	5.0	112.86
S60700TB00	3/4"	9.0	125.28
S61000TB00	1"	13.0	140.60
S61500TB00	1-1/2"	35.0	237.20
S62000TB00	2"	77.0	282.14
<b>C</b>			
S60500CE00	1/2"	5.0	103.30
S60700CE00	3/4"	9.0	109.99
S61000CE00	1"	13.0	121.47
S61200CE00	1-1/4"	24.0	202.76
S61500CE00	1-1/2"	35.0	215.20
S62000CE00	2"	77.0	310.85
<b>X</b>			
S60500XB00	1/2"	5.0	128.16
S60700XB00	3/4"	9.0	141.54
S61000XB00	1"	13.0	162.60
S61500XB00	1-1/2"	35.0	269.72
S62000XB00	2"	77.0	410.32

E Conduit, Fittings & Boxes





### LAY-IN AND TROFFER SUPPORT CLIP

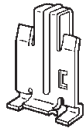

515A or BA15

Vendor Code: **CAD** (Caddy)

Catalog Number	Description	Carton Quantity	Price per 100 pcs.
<b>515A</b>	Lay-in and Troffer Support Clip	100	58.76

Complies with NEC Article 410-16

Vendor Code: **BLI** (Eaton B-Line Series)

Catalog Number	Description	Carton Quantity	Price per 100 pcs.
<b>BA15</b>	Lay-in and Troffer Support Clip	100	69.39

Complies with NEC Article 410-16

### ACOUSTICAL T-BAR FITTINGS



812MATA or BG812A6



ATS41 or BA54T

Vendor Code: **CAD** (Caddy)

Catalog Number	Description	Carton Quantity	Price per 100 pcs.
<b>ATS41</b>	Side Mount with 1/4" thd	100	76.38
<b>812MATA</b>	Top Mount for 1/2" or 3/4" Conduit	100	162.16

Vendor Code: **BLI** (Eaton B-Line Series)

Catalog Number	Description	Carton Quantity	Price per 100 pcs.
<b>BA54T</b>	Side Mount with 1/4" thd	100	109.77
<b>BG812A6</b>	Top Mount for 1/2" or 3/4" Conduit	100	157.91

## EATON B-Line series

### BAR HANGERS

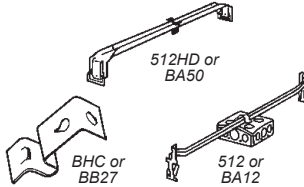

Vendor Code: **CAD** (Caddy)

Catalog Number	Description	Carton Quantity	Price per 100 pcs.
<b>512</b>	24" Adj. Bar Hanger	50	940.30
<b>512HD</b>	T-Bar Box Hanger	25	811.01
<b>BHC</b>	Box Mounting Clip	100	58.41

Vendor Code: **BLI** (Eaton B-Line Series)

Catalog Number	Description	Carton Quantity	Price per 100 pcs.
<b>BA12</b>	24" Adj. Bar Hanger	50	892.77
<b>BA50</b>	T-Bar Box Hanger	25	882.23
<b>BB27</b>	Box Mounting Clip	100	63.85

### Z PURLIN CLIPS

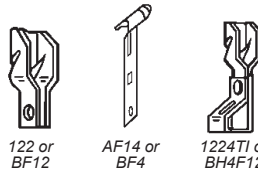

Vendor Code: **CAD** (Caddy)

Catalog Number	Description	Ctn. Qty.	Price per 100 pcs.
<b>122</b>	Wrap Wire or "S" Hook	100	76.05
<b>1224T1</b>	For 1/4" Threaded Rod	100	163.77
<b>AF14</b>	HSC Snap Clips	100	65.81

Vendor Code: **BLI** (Eaton B-Line Series)

Catalog Number	Description	Ctn. Qty.	Price per 100 pcs.
<b>BF12</b>	Wrap Wire or "S" Hook	100	79.16
<b>BH4F12</b>	For 1/4" Threaded Rod	100	193.98
<b>BF4</b>	HSC Snap Clips	100	73.31

### FLANGE CLIPS

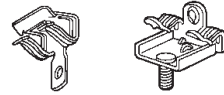

4H24 or BF24

M24S or BU24S

Vendor Code: **CAD** (Caddy)

Catalog Number	Description	Carton Quantity	Price per 100 pcs.
<b>1/4" HOLE</b>			
<b>4H24</b>	1/8" - 1/4"	100	74.05
<b>1/4" SCREW</b>			
<b>M24S</b>	1/8" - 1/4"	100	123.39

Vendor Code: **BLI** (Eaton B-Line Series)

Catalog Number	Description	Carton Quantity	Price per 100 pcs.
<b>1/4" HOLE</b>			
<b>BE24</b>	1/8" - 1/4"	100	88.50
<b>1/4" SCREW</b>			
<b>BU24S</b>	1/8" - 1/4"	100	120.73

### BEAM CLAMPS

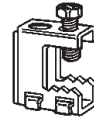

BC or BC1

Vendor Code: **CAD** (Caddy)

Catalog Number	Flange Thickness	Carton Quantity	Price per 100 pcs.
<b>BC</b>	Up to 1/2"	100	131.21

Vendor Code: **BLI** (Eaton B-Line Series)

Catalog Number	Flange Thickness	Carton Quantity	Price per 100 pcs.
<b>BC1</b>	Up to 1/2"	100	143.76

### TWIST ON FIXTURE SUPPORT

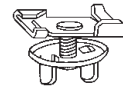

4G16 or BA416

Vendor Code: **CAD** (Caddy)

Catalog Number	Stud Size	Carton Quantity	Price per 100 pcs.
<b>4G16</b>	1/4-20 x 5/8	100	117.80

Vendor Code: **BLI** (Eaton B-Line Series)

Catalog Number	Stud Size	Carton Quantity	Price per 100 pcs.
<b>BA416</b>	1/4-20 x 5/8	100	117.72

E  
Conduit, Fittings & Boxes

**COMBINATION CONDUIT HANGER CLAMPS SNAP CLOSE TYPE**



Bottom



Side

Vendor Code: **CAD** (Caddy)

Catalog Number	Pipe Size	Carton Quantity	Price per 100 pcs.
<b>BOTTOM MOUNTING</b>			
<b>6M24</b>	3/8"	100	229.18
<b>812M24</b>	1/2" & 3/4"	100	188.05
<b>16M24</b>	1"	100	223.30
<b>20M24</b>	1-1/4"	50	270.32
<b>SIDE MOUNTED</b>			
<b>812M24SM</b>	1/2" & 3/4"	100	149.26
<b>16M24SM</b>	1"	100	183.35
<b>20M24SM</b>	1-1/4"	100	223.28

The Above Fits Beam Flanges 1/8" to 1/4" Thick.

Vendor Code: **BLI** (Eaton B-Line Series)

Catalog Number	Pipe Size	Ctn. Qty.	Price per 100 pcs.
<b>BOTTOM MOUNTING</b>			
<b>BG6U24</b>	3/8" Beam Clip	100	228.85
<b>BG812U24</b>	1/2"-3/4" Beam Clip	100	182.10
<b>BG16U24</b>	1" Beam Clip	100	242.50
<b>BG20U24</b>	1-1/4" Beam Clip	100	263.12
<b>SIDE MOUNTING</b>			
<b>BG812E24</b>	1/2" & 3/4" Beam Clip	100	161.63
<b>BG16E24</b>	1" Beam Clip	100	196.70
<b>BG20E24</b>	1-1/4" Beam Clip	100	239.09

The Above Fits Beam Flanges 1/8" to 1/4" Thick.

**PUSH-IN TYPE**



Bottom



Side

Vendor Code: **CAD** (Caddy)

Catalog Number	Pipe Size	Carton Quantity	Price per 100 pcs.
<b>TOP MOUNTED</b>			
<b>8P24</b>	1/2"	100	188.05
<b>12P24</b>	3/4"	100	191.61
<b>SIDE MOUNTED</b>			
<b>8P24SM</b>	1/2"	100	153.51
<b>12P24SM</b>	3/4"	100	155.16

The Above Fits Beam Flanges 1/8" to 1/4" Thick.

Vendor Code: **BLI** (Eaton B-Line Series)

Catalog Number	Pipe Size	Carton Quantity	Price per 100 pcs.
<b>TOP MOUNTED</b>			
<b>BP8U24</b>	1/2"	100	215.29
<b>BP12U24</b>	3/4"	100	233.76
<b>SIDE MOUNTED</b>			
<b>BP8E24</b>	1/2"	100	178.98
<b>BP12E24</b>	3/4"	100	172.90

The Above Fits Beam Flanges 1/8" to 1/4" Thick.

**CONDUIT TO CONDUIT CLAMPS**



Vendor Code: **CAD** (Caddy)

Catalog Number	Pipe Size	Carton Quantity	Price per 100 pcs.
<b>8P8P</b>	1/2"	100	136.99
<b>12P12P</b>	3/4"	100	141.73

Vendor Code: **BLI** (Eaton B-Line Series)

Catalog Number	Pipe Size	Carton Quantity	Price per 100 pcs.
<b>BP8P8</b>	1/2"	100	160.56
<b>BP12P12</b>	3/4"	100	167.24

**CONDUIT CLIPS**



Vendor Code: **CAD** (Caddy)

Catalog Number	Pipe Size	Carton Quantity	Price per 100 pcs.
<b>K8</b>	1/2"	100	48.15
<b>K12</b>	1/2" - 3/4"	100	52.86
<b>K16</b>	3/4" - 1"	100	64.64
<b>K20</b>	3/4" - 1"	100	91.90

Vendor Code: **BLI** (Eaton B-Line Series)

Catalog Number	Pipe Size	Carton Quantity	Price per 100 pcs.
<b>BW8</b>	1/2" Batwing	100	56.60
<b>BW12</b>	1/2" - 1" Batwing	100	71.56
<b>BW16</b>	3/4" - 1" Batwing	100	82.02
<b>BW20</b>	3/4" - 1" Batwing	100	122.96

**SWITCH BOX OR CONDUIT TO METAL STUD CLIP**

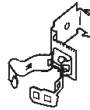

812MF or BG812B5

Vendor Code: **CAD** (Caddy)

Catalog Number	Pipe Size	Carton Quantity	Price per 100 pcs.
<b>812MF</b>	1/2" & 3/4"	100	186.73

Vendor Code: **BLI** (Eaton B-Line Series)

Catalog Number	Pipe Size	Carton Quantity	Price per 100 pcs.
<b>BG812B5</b>	1/2" & 3/4"	100	182.10

**EAT·N**  
B-Line series

**CONDUIT SUPPORTS SCREW-ON TYPE**

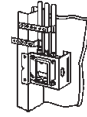

CS812D or BB38D

Vendor Code: **CAD** (Caddy)

Catalog Number	Pipe Size	Carton Quantity	Price per 100 pcs.
<b>CS812D</b>	1/2" & 3/4"	100	65.36

Vendor Code: **BLI** (Eaton B-Line Series)

Catalog Number	Pipe Size	Carton Quantity	Price per 100 pcs.
<b>BB38D</b>	1/2" & 3/4"	100	69.93

**ANTI-RATTLE**

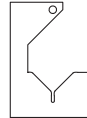

781 or BX82

Vendor Code: **CAD** (Caddy)

Catalog Number	Pipe Size	Carton Quantity	Price per 100 pcs.
<b>781</b>	Up to 1"	100	50.15

Vendor Code: **BLI** (Eaton B-Line Series)

Catalog Number	Pipe Size	Carton Quantity	Price per 100 pcs.
<b>BX82</b>	Up to 1"	100	59.61

**MC TO METAL STUD STRAP**



449 or BX9

Vendor Code: **CAD** (Caddy)

Catalog Number	Cable Size	Carton Quantity	Price per 100 pcs.
<b>449</b>	14/2 - 12/3	100	92.62

Vendor Code: **BLI** (Eaton B-Line Series)

Catalog Number	Cable Size	Carton Quantity	Price per 100 pcs.
<b>BX9</b>	14/2 - 12/3	100	98.36

**CADDY**<sup>®</sup>

E Conduit, Fittings & Boxes





## MC Hangers · Drop Wire · Dottie Pipe Supports

### MC HANGERS FROM DROP WIRE



KX or BW4



PCS1 or BX8

Vendor Code: **CAD** (Caddy)

Catalog Number	Cable Size	Carton Quantity	Price per 100 pcs.
<b>KX</b>	14/2, 14/3, 12/2, 12/3	100	54.06
<b>PCS1</b>	14/2 - 10/3	100	65.00

Vendor Code: **BLI** (Eaton B-Line Series)

Catalog Number	Cable Size	Carton Quantity	Price per 100 pcs.
<b>BW4</b>	14/2, 14/3, 12/2, 12/3	100	68.40
<b>BX8</b>	14/2 - 10/3	100	76.74

### PIPE AND EQUIPMENT SUPPORT

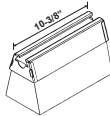

Vendor Code: **CAD** (Caddy)

Catalog Number	Description	Price per 100 pcs.
<b>50-POUND SUPPORT</b>		
<b>RPS50H4EG</b>	4" High EG Finish, 10-3/8" Length	3263.05
<b>RPS50H6EG</b>	6" High EG Finish, 10-3/8" Length	3985.39

Vendor Code: **BLI** (Eaton B-Line Series)

Catalog Number	Description	Price Each
<b>500-POUND SUPPORT</b>		
<b>DB10</b>	Base w/ 14 ga. Galv Channel	28.86

### INDEPENDENT ELECTRICAL DROP WIRE/ROD SECURING CLIP

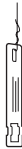

EC311 or BA311

Vendor Code: **CAD** (Caddy)

Catalog Number	Description	Carton Quantity	Price per 100 pcs.
<b>EC311</b>	#13 Clip, Up To #8 Wire	100	146.91

Vendor Code: **BLI** (Eaton B-Line Series)

Catalog Number	Description	Carton Quantity	Price per 100 pcs.
<b>BA311</b>	#13 Clip, Up To #8 Wire	100	142.20



### DOTTIE PIPE SUPPORTS

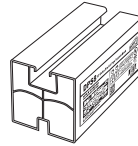

DPS8

Dottie Pipe Supports are a revolutionary, lightweight, and cost effective solution for rooftop pipe supports. Their unique design makes it light enough to easily carry to the roof but strong enough to support extremely heavy loads. The Pipe Support is UV stabilized ABS/AES material and maintains its effectiveness and characteristics within a temperature range from -40°C (-40°F) to 100°C (212°F). The supports dual-channel configuration accepts strut straps (in the large channel) and 3/8" bolts and 3/8" threaded rods (in the small channel). The 4" pipe supports (DPS) can be cut to any length to fit any job thereby reducing waste. The versatile 8" precut (DPS8) is a fast and easy solution for any job. With a load resistance of 130 lbs / in, dual-channel design, they are the smart choices for any job, in any climate.

- Water & weatherproof
- Built-in dual channels for strut straps and 3/8" bolts & 3/8" threaded rods
- Load resistance = 130 lbs/in
- Cut-to-length & Precut lengths

Vendor Code: **DOT**

Catalog Number	Description	Price Each
<b>DPS</b>	4 Foot Pipe Support	70.68
<b>DPS8</b>	8 Inch Precut Pipe Support	11.79



Conduit, Fittings & Boxes



### SCREW GUN BRACKETS FOR BETWEEN STUDS

Vendor Code: **CAD** (Caddy)

Catalog Number	Description	Carton Quantity	Price per 100 pcs.
<b>1-1/2" OR 2-1/8" DEEP BOXES</b>			
<b>SGB16A</b>	16" Preset	50	437.03
<b>TSGB16</b>	11" - 18" Adjustable	50	410.55
<b>TSGB24</b>	17" - 26" Adjustable	50	596.26

Vendor Code: **BLI** (Eaton B-Line Series)

Catalog Number	Description	Carton Quantity	Price per 100 pcs.
<b>1-1/2" OR 2-1/8" DEEP BOXES</b>			
<b>BB216</b>	16" Preset	50	413.75
<b>BB216T</b>	11" - 18" Adjustable	50	396.36
<b>BB224T</b>	17" - 26" Adjustable	50	560.81

### LOW-VOLTAGE CLASS 2 MOUNTING BRACKETS (NO BOX REQUIRED)

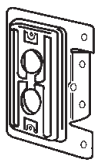

MP1S or BB15



MPLS or BB10L



MP1P or BB10P

Vendor Code: **CAD** (Caddy)

Catalog Number	Description	Carton Quantity	Price per 100 pcs.
<b>METAL BRACKETS FOR DRYWALL</b>			
<b>MP1S</b>	1 Gang, 1/2" - 5/8"	25	185.66
<b>MPLS</b>	*1 Gang, 1/2" - 1-1/4"	100	242.04
<b>PLASTIC BRACKETS FOR DRYWALL</b>			
<b>MP1P</b>	1 Gang, 1/4" - 1-1/4"	100	196.15

\*Includes Locking Screws.

Vendor Code: **BLI** (Eaton B-Line Series)

Catalog Number	Description	Carton Quantity	Price per 100 pcs.
<b>METAL BRACKETS FOR DRYWALL</b>			
<b>BB15</b>	1 Gang, 1/2" - 5/8"	25	191.59
<b>BB10L</b>	*1 Gang, 1/2" - 1-1/4"	100	244.95
<b>PLASTIC BRACKETS FOR DRYWALL</b>			
<b>BB10P</b>	1 Gang, 1/4" - 1-1/4"	100	234.36

\*Includes Locking Screws.

**EATON**  
B-Line series

### LOW-VOLT MOUNTING BRACKETS

Vendor Code: **ARL**

Catalog Number	Description	Carton Quantity	Price per 100 pcs.
<b>1 GANG</b>			
<b>LV1</b>	Remodel	10	140.65
<b>LVMB1</b>	New Construction	10	119.04
<b>LVN1</b>	Nail-on New Construction	50	78.31

### MOUNTING BRACKET FOR ANY ELECTRIC BOX

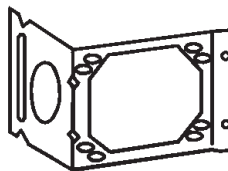

- Replaces H-Brackets with improved design
- Thicker steel to significantly increase rigidity and help prevent box movement and trim out issues
- Works with both standard and adjustable single and double gang mud rings
- Mounts plaster rings for low voltage applications
- Additional bend points on C4 and C6 brackets for greater versatility

Vendor Code: **CAD** (Caddy)

Catalog Number	Description	Carton Quantity	Price per 100 pcs.
<b>METAL OR WOOD STUD</b>			
<b>C4</b>	2-1/2" - 4"	100	244.61
<b>C6</b>	2-1/2" - 6"	50	291.75
<b>C23</b>	2-1/2" - 3-5/8"	100	233.37

Vendor Code: **BLI** (Eaton B-Line Series)

Catalog Number	Description	Carton Quantity	Price per 100 pcs.
<b>METAL OR WOOD STUD</b>			
<b>BB44</b>	2-1/2" - 4"	100	226.47
<b>BB46</b>	2-1/2" - 6"	50	277.28
<b>BB423</b>	2-1/2" - 3-5/8"	100	177.35

**CADDY**<sup>®</sup>



## BOX MOUNTING BRACKETS

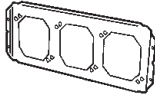

RBS16 or BB816

Vendor Code: **CAD** (Caddy)

Catalog Number	Spaces	Bracket Length	Ctn. Qty.	Price per 100 pcs.
RBS16	3	16"	25	540.94

Vendor Code: **BLI** (Eaton B-Line Series)

Catalog Number	Spaces	Bracket Length	Ctn. Qty.	Price per 100 pcs.
BB816	3	16"	25	494.38

## EASY SNAP GROMMETS FOR METAL STUDS

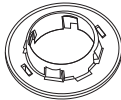

ESG1 or BMI

Vendor Code: **CAD** (Caddy)

Catalog Number	Description	Ctn. Qty.	Price per 100 pcs.
ESG1	Snap-In Grommets	100	51.37

Vendor Code: **BLI** (Eaton B-Line Series)

Catalog Number	Description	Ctn. Qty.	Price per 100 pcs.
BM1	Snap-In Grommets	100	50.43

## CABLE SUPPORT "COLORADO JIM"

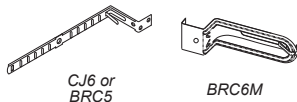

C/J6 or BRC5

BRC6M

Vendor Code: **CAD** (Caddy)

Catalog Number	Spaces	Carton Quantity	Price per 100 pcs.
CJ6	NM: 6 Cable Max. MC: 4 Cable Max.	100	101.95

Vendor Code: **BLI** (Eaton B-Line Series)

Catalog Number	Description	Carton Quantity	Price per 100 pcs.
BRCJ	NM: 6 Cable Max. MC: 4 Cable Max.	100	107.76
BRC6M	1-1/4" Stud Size	100	117.51



## HEAVY-DUTY SLIDING BAR CEILING FAN HANGER

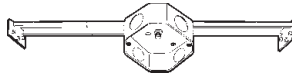

- Supports fans up to 70 lbs., and fixtures up to 110 lbs.
- Female stud protects wiring
- Supported by 15 threads
- 16 cubic inch box
- Installs in less than one minute
- Pre-assembled, including ground screw
- No sagging with solid steel inner slide
- Fits 16" – 24" joist

Vendor Code: **PAS**

Catalog Number	Description	Carton Quantity	Price Each
65501	With Octagon Box	25	10.30

## HEAVY-DUTY CEILING FAN HANGER

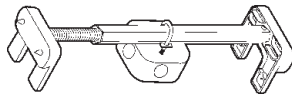

- Supports fans up to 60 lbs., and fixtures up to 100 lbs.
- Expands to fit 16" or 24" joists
- Only minutes to install
- Works with any octagon box

Vendor Code: **PAS**

Catalog Number	Description	Carton Quantity	Price Each
33310	Safety Brace	12	28.38

## ECONOMY CEILING FAN HANGER

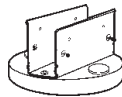

- Supports fans up to 70 lbs., and fixtures up to 150 lbs.
- Female stud protects wiring
- Supported by 15 threads
- 8 cubic inch box, directly mounted to joist

Vendor Code: **PAS**

Catalog Number	Description	Carton Quantity	Price Each
77706	Ceiling Fan Hanger	24	7.99



## FAN BOXES

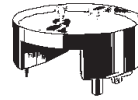

### FB405

The FB405 offers the flexible, economical solution to 1/2" and 5/8" drywall ceiling, with or without hat channel or furring strips. The FB405 is perfect for double joists or wood I-beams.

### FB415

FB415 comes with the screws you need to install the box and bracket, held captive until you're ready to use them. These boxes have gripping tangs that press-hold the box to the joist while you reach for your screwdriver. Tightening the center screw affixes the box onto the joist for a supersecure installation.

Vendor Code: **ARL**

Catalog Number	Description	Ctn. Qty.	Price per 100 pcs.
<b>FOR 1/2" AND 5/8" DRYWALL</b>			
FB405	Pancake Fanbox	25	383.49
FB415	Fanbox	25	389.56

2-hour fire rating

UL Rated: 70 lb. fans, fixtures up to 200 lbs.  
CSA: Fans/fixtures up to 50 lbs.

## ROUND BOX COVERS

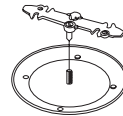

Covers unused 3-1/2" and 4" round and octagonal boxes prior to the installation of a fan or fixture. Non-rusting, paintable plastic.

- Deeper cover works with pan boxes without the need to cut the post
- Use #8 screws provided or back out existing screws to accept notched bracket
- Bracket has two separate cover mounting options. Threaded post pushes in, for flat ceilings, or screws on for textured/uneven ceilings.

Vendor Code: **ARL**

Catalog Number	Description	Ctn. Qty.	Price per 100 pcs.
CP3540	Combination Ceiling Plate	50	182.54



E  
Conduit, Fittings & Boxes



Square Bottom Boxes · Box Extenders · Octagon Boxes · Green Ground Screws

SQUARE BOTTOM

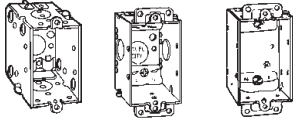

LXWLE25 or TP158    LXWOW25 or TP162    SWB25 or TP100

Vendor Code: **TAB** (ABB Installation Products)

Catalog Number	Gangable	Ears	Cu. In.	Ctn. Qty.	Price per 100 pcs.
<b>1-1/2" DEEP</b>					
LXWLE	Yes	No	12.5	25	338.18
SWB25	No	Yes	7.5	25	487.74
<b>2-1/2" DEEP</b>					
LXWOW25	Yes	Yes	12.5	25	298.60
<b>3-1/2" DEEP</b>					
CXW0W	Yes	Yes	18.0	25	513.16

Vendor Code: **CRS** (Eaton Crouse-Hinds Series)

Catalog Number	Gangable	Ears	Cu. In.	Ctn. Qty.	Price per 100 pcs.
<b>1-1/2" DEEP</b>					
TP100	No	Yes	7.5	50	460.06
<b>2-1/2" DEEP</b>					
TP158	Yes	No	12.5	50	421.56
TP162	Yes	Yes	12.5	50	280.70
<b>3-1/2" DEEP</b>					
TP238	Yes	Yes	18.0	25	486.07

BOX EXTENDERS

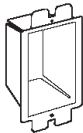

Vendor Code: **ARL**

Catalog Number	Description	Ctn. Qty.	Price per 100 pcs.
BE1	1 Gang Plastic	25	166.52
BE2	2 Gang Plastic	25	232.37

SHEETROCK SUPPORT



Vendor Code: **TAB** (ABB Installation Products)

Catalog Number	Description	Ctn. Qty.	Price per 100 pcs.
820D	Sheetrock Support (2)	500	85.37

Vendor Code: **CRS** (Eaton Crouse-Hinds Series)

Catalog Number	Description	Ctn. Qty.	Price per 100 pcs.
TP708	Sheetrock Support (2)	500	55.37

3-1/4" OCTAGON

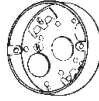

36115C30 or TP266

Vendor Code: **TAB** (ABB Installation Products)

Catalog Number	Cubic Inch	Carton Quantity	Price per 100 pcs.
<b>1/2" DEEP PANCAKE BOX</b>			
36115C30	4.0	30	250.24

Vendor Code: **CRS** (Eaton Crouse-Hinds Series)

Catalog Number	Cubic Inch	Carton Quantity	Price per 100 pcs.
<b>1/2" DEEP PANCAKE BOX</b>			
TP266	4.0	50	217.90

3-1/2" OCTAGON

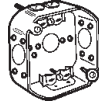

24151N25 or TP260

Vendor Code: **TAB** (ABB Installation Products)

Catalog Number	Cubic Inch	Carton Quantity	Price per 100 pcs.
<b>1-1/2" DEEP W/CLAMPS</b>			
24151N25	11.8	25	666.92

Vendor Code: **CRS** (Eaton Crouse-Hinds Series)

Catalog Number	Cubic Inch	Carton Quantity	Price per 100 pcs.
<b>1-1/2" DEEP W/CLAMPS</b>			
TP260	11.5	50	641.41

4" OCTAGON

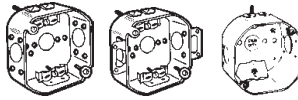

54151N or TP298    54151NE or TP306    54171N or TP316

Vendor Code: **TAB** (ABB Installation Products)

Catalog Number	Ears	Cubic Inch	Ctn. Qty.	Price per 100 pcs.
<b>1-1/2" DEEP</b>				
54151N	No	15.8	50	298.58
54151NE	Yes	15.8	50	507.63
<b>2-1/8" DEEP</b>				
54171N25	No	22.5	25	593.34

Vendor Code: **CRS** (Eaton Crouse-Hinds Series)

Catalog Number	Ears	Cubic Inch	Ctn. Qty.	Price per 100 pcs.
<b>1-1/2" DEEP</b>				
TP306	Yes	15.5	50	303.32
<b>2-1/8" DEEP</b>				
TP316	No	21.5	25	570.99

4" OCTAGON CEILING FAN BOX

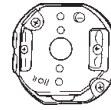

54151CFB or TP275

Vendor Code: **TAB** (ABB Installation Products)

Catalog Number	Ears	Cu. In.	Fan Support	Ctn. Qty.	Price per 100 pcs.
<b>1-1/2" DEEP</b>					
54151CFB	No	15.8	Yes	10	735.96

Vendor Code: **CRS** (Eaton Crouse-Hinds Series)

Catalog Number	Ears	Cu. In.	Fan Support	Ctn. Qty.	Price per 100 pcs.
<b>1-1/2" DEEP</b>					
TP275	No	15.5	Yes	20	635.20
<b>1/2" DEEP</b>					
TP301	No	6.0	Yes	20	498.76

GROUNDING CLIPS



GEE or TP706

Vendor Code: **TAB** (ABB Installation Products)

Catalog Number	Description	Ctn. Qty.	Price per 100 pcs.
GEE	Grounding Clip	1,000	39.63

Vendor Code: **CRS** (Eaton Crouse-Hinds Series)

Catalog Number	Description	Ctn. Qty.	Price per 100 pcs.
TP706	Grounding Clip	1,000	37.92

GREEN GROUND SCREWS

10/32 X 3/8"



1032TC

Vendor Code: **DOT**

Catalog Number	Description	Ctn. Qty.	Price per 100 pcs.
<b>LEADER POINT</b>			
1032G	1/4" Hex	100	5.11
<b>THREAD CUTTING</b>			
1032TC	5/16" Hex	100	6.46



E Conduit, Fittings & Boxes



### SWITCH BOX GANGABLE NO EARS

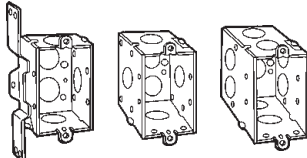

CDV25/CWV12 CDLE25/CWLE1225 CYLE12

Vendor Code: **TAB** (ABB Installation Products)

Catalog Number	Box Depth	Cubic Inch	Ctn. Qty.	Price per 100 pcs.
<b>1/2" KO'S WITH STUD BRACKET</b>				
CDV25	2-1/2"	12.5	25	305.69
CWV12	2-3/4"	14.0	25	507.94
<b>1/2" KO'S</b>				
CDLE25	2-1/2"	12.5	25	381.42
CWLE1225	2-3/4"	14.0	25	388.58
CYLE12	3-1/2"	18.0	25	319.00

Images above represent ABB products.

Vendor Code: **CRS** (Eaton Crouse-Hinds Series)

Catalog Number	Box Depth	Cubic Inch	Ctn. Qty.	Price per 100 pcs.
<b>1/2" KO'S WITH STUD BRACKET</b>				
TP222	2-1/2"	12.5	50	286.07
TP680	2-3/4"	14.0	50	488.81
<b>1/2" KO'S</b>				
TP214	2-1/2"	12.5	50	353.39
TP672	2-3/4"	14.0	50	373.97
TP248	3-1/2"	18.0	25	306.97

### SWITCH BOX GANGABLE WITH EARS

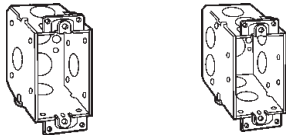

CW12/CDOW

CY12

Vendor Code: **TAB** (ABB Installation Products)

Catalog Number	Box Depth	Cubic Inch	Ctn. Qty.	Price per 100 pcs.
<b>WITH 1/2" KO'S</b>				
CDOW	2-1/2"	12.5	50	193.10
CW12	2-3/4"	14.0	50	335.58
CY12	3-1/2"	18.0	25	353.59
<b>WITH 3/4" KO'S</b>				
CW3425	2-3/4"	14.0	25	450.77
CY34	3-1/2"	18.0	25	556.02

Images above represent ABB products.

Vendor Code: **CRS** (Eaton Crouse-Hinds Series)

Catalog Number	Box Depth	Cubic Inch	Ctn. Qty.	Price per 100 pcs.
<b>WITH 1/2" KO'S</b>				
TP218	2-1/2"	12.5	50	182.46
TP676	2-3/4"	14.0	50	225.67
TP252	3-1/2"	18.0	25	266.86
<b>WITH 3/4" KO'S</b>				
TP678	2-3/4"	14.0	50	425.87
TP254	3-1/2"	18.0	25	527.01

### 4" OCTAGON

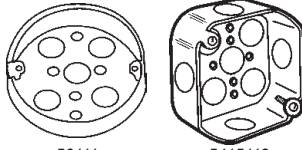

56111 or TP269

5415112 or TP274

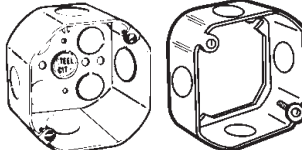

541711225 or TP288

551511225 or TP284

Vendor Code: **TAB** (ABB Installation Products)

Catalog Number	KO'S	Cubic Inch	Ctn. Qty.	Price per 100 pcs.
<b>4" ROUND 1/2" DEEP</b>				
56111	1/2"	6.0	50	165.65
<b>4" OCTAGON 1-1/2" DEEP</b>				
5415112	1/2"	15.8	50	182.58
541511234	1/2" & 3/4"	15.8	50	184.57
5415134	3/4"	15.8	50	144.33
<b>4" OCTAGON 2-1/8" DEEP</b>				
541711225	1/2"	22.5	25	329.79
541711234	1/2" & 3/4"	22.5	25	332.71
5417134	3/4"	22.5	25	325.80
<b>4" OCTAGON 1-1/2" DEEP EXTENSION</b>				
551511225	1/2"	15.8	25	365.80
551511234	1/2" & 3/4"	15.8	25	455.61

Vendor Code: **CRS** (Eaton Crouse-Hinds Series)

Catalog Number	KO'S	Cubic Inch	Ctn. Qty.	Price per 100 pcs.
<b>4" ROUND 1/2" DEEP, NO CLAMPS</b>				
TP269	1/2"	6.0	50	157.76
<b>4" OCTAGON 1-1/2" DEEP</b>				
TP274	1/2"	15.5	50	173.36
TP278	1/2" & 3/4"	15.5	50	162.78
TP276	3/4"	15.5	50	146.29
<b>4" OCTAGON 2-1/8" DEEP</b>				
TP288	1/2"	21.5	25	310.01
TP292	1/2" & 3/4"	21.5	25	354.60
TP290	3/4"	21.5	25	313.56
<b>4" OCTAGON 1-1/2" DEEP EXTENSION</b>				
TP284	1/2"	15.5	50	355.56
TP286	1/2" & 3/4"	15.5	50	422.95

### OCTAGON BOX COVERS

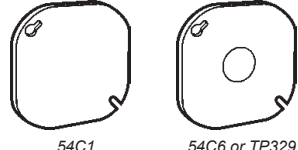

54C1 or TP322

54C6 or TP329 or TP328

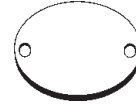

CCRB or TP323

Vendor Code: **TAB** (ABB Installation Products)

Catalog Number	Description	Ctn. Qty.	Price per 100 pcs.
<b>3-1/2" COVER</b>			
24C125	Flat Blank	50	142.20
24C6	Flat 1/2" KO	50	155.36
<b>4" COVER</b>			
54C1	Flat Blank	50	80.62
54C6	Flat 1/2" KO	50	90.29
<b>4" - CEILING BOX COVER UP</b>			
CCRB	Flat Blank CRS	15	296.67

Vendor Code: **CRS** (Eaton Crouse-Hinds Series)

Catalog Number	Description	Ctn. Qty.	Price per 100 pcs.
<b>3-1/2" COVER</b>			
TP270	Flat Blank	100	136.84
TP272	Flat 1/2" KO	100	149.53
<b>4" COVER</b>			
TP323	Flat Blank	50	69.29
TP328	Flat 1/2" KO	50	77.33

### ADJUSTABLE BAR HANGERS PLASTER OR DRYWALL



Vendor Code: **TAB** (ABB Installation Products)

Catalog Number	Use Between Joints	Ctn. Qty.	Price per 100 pcs.
<b>FOR 3/8", 1/2" &amp; 5/8" WALLBOARD (50 LB)</b>			
6011ADW25	Fastener, 24" OC Min. 14-1/2" Max. 22-1/2"	25	597.94

Vendor Code: **CRS** (Eaton Crouse-Hinds Series)

Catalog Number	Use Between Joints	Ctn. Qty.	Price per 100 pcs.
TP352	Stud, 16 & 24" OC		1152.42
TP356	Stud, 16" OC Min. 14", Max. 22-1/2"	50	519.87



Crouse-Hinds series

E  
Conduit, Fittings & Boxes

4" (Square Boxes · Device Ring Covers · Square Covers · Square Cut Tile Wall Covers)

4" SQUARE BOXES

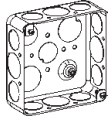

52151234  
or TP414

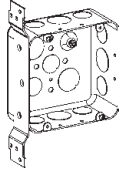

52151CV1234  
or 5217CV1234  
or TP423/TP451

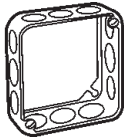

5315112  
or TP428

Vendor Code: **TAB** (ABB Installation Products)

Catalog Number	KO's	Cu. In.	Ctn. Qty.	Price per 100 pcs.
----------------	------	---------	-----------	--------------------

1-1/2" DEEP BOXES - NO BRACKET

5215112	1/2"	21.0	50	142.17
5215134	3/4"	21.0	50	135.07
521511234	1/2" & 3/4"	21.0	50	137.88
521511234EW*	1/2" & 3/4"	21.0	50	127.94

1-1/2" DEEP BOXES - VMS BRACKET

52151CV1234	1/2" & 3/4"	21.0	25	233.20
-------------	-------------	------	----	--------

1-1/2" EXTENSION RINGS

5315112	1/2"	21.0	50	274.16
531511234	1/2" & 3/4"	21.0	50	291.47

2-1/8" DEEP BOXES - NO BRACKET

521711234E**	1/2" & 3/4"	30.3	50	227.48
5217134	3/4"	30.3	50	221.78
521711	1"	30.3	50	327.01

2-1/8" DEEP BOXES - VMS BRACKET

52171CV1234	1/2" & 3/4"	30.3	25	327.03
-------------	-------------	------	----	--------

\*Welded Box  
\*\*Eccentric Knockouts

Vendor Code: **CRS** (Eaton Crouse-Hinds Series)

Catalog Number	KO's	Cu. In.	Ctn. Qty.	Price per 100 pcs.
----------------	------	---------	-----------	--------------------

1-1/2" DEEP BOXES - NO BRACKET

TP410	1/2"	21.0	50	135.90
TP412	1/2" & 3/4"	21.0	50	126.49
TP414	1/2" & 3/4"	21.0	50	123.86
TP404*	1/2" & 3/4"	22.0	50	123.51

1-1/2" DEEP BOXES - CV BRACKET

TP423	1/2" & 3/4"	22.0	25	216.02
-------	-------------	------	----	--------

1-1/2" EXTENSION RINGS

TP424	1/2"	21.0	50	307.93
TP428	1/2" & 3/4"	21.0	50	274.56

2-1/8" DEEP BOXES - NO BRACKET

TP438	1/2" & 3/4"	30.3	25	189.29
TP432	3/4"	30.3	25	220.62
TP436	1"	30.3	25	304.37

2-1/8" DEEP BOXES - CV BRACKET

TP451	1/2" & 3/4"	30.3	25	302.30
-------	-------------	------	----	--------

\*Welded Box

4" DEVICE RING COVERS



One Device

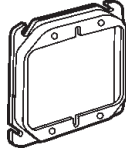

Two Device

Vendor Code: **TAB** (ABB Installation Products)

Catalog Number	Raised	Ctn. Qty.	Price per 100 pcs.
<b>ONE DEVICE</b>			
52C0	Flat	25	94.84
52C62	1/4"	25	87.24
52C13	1/2"	50	79.45
52C1458	5/8"	50	88.02
52C14	3/4"	50	99.48
52C15	1"	25	98.76
52C16	1-1/4"	25	150.71
<b>FOR TWO DEVICES</b>			
52C00	Flat	25	113.99
52C2025	1/4"	25	170.08
52C1725	1/2"	25	122.32
52C185825	5/8"	50	113.59
52C18	3/4"	25	123.68
52C19	1"	25	294.83
52C21	1-1/4"	25	317.66

Vendor Code: **CRS** (Eaton Crouse-Hinds Series)

Catalog Number	Raised	Ctn. Qty.	Price per 100 pcs.
<b>ONE DEVICE</b>			
TP480	Flat	50	91.29
TP482	1/4"	50	82.89
TP484	1/2"	50	66.20
TP489	5/8"	50	83.61
TP486	3/4"	50	86.51
TP488	1"	50	82.23
TP490	1-1/4"	25	138.04
<b>FOR TWO DEVICES</b>			
TP494	Flat	50	98.57
TP496	1/4"	50	160.87
TP498	1/2"	50	117.72
TP499	5/8"	50	99.74
TP500	3/4"	50	118.40
TP502	1"	25	226.97
TP501	1-1/4"	25	305.74

FLEXIBLE FIXTURE HANGERS FOR 4" BOXES



Vendor Code: **CRS**

Catalog Number	Description	Price per 100 pcs.
TPSFH12	4" Square Box Cover	1810.94
TPRFH12	4" Round or Oct. Cover	1700.40

3/4" Thread, Supplied with 3/4 x 1/2 RE

4" SQUARE COVERS

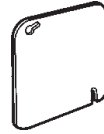

52C1 or TP472

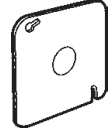

52C6 or TP478

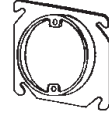

52C312 or TP476

Vendor Code: **TAB** (ABB Installation Products)

Catalog Number	Description	Ctn. Qty.	Price per 100 pcs.
52C1	Flat Blank	50	55.28
52C6	Flat 1/2" KO	50	82.20
52C31225	1/2" Raised	25	107.68
52C325	3/4" Raised	25	96.91
52C31	1" Raised	25	216.59

Vendor Code: **CRS** (Eaton Crouse-Hinds Series)

Catalog Number	Description	Ctn. Qty.	Price per 100 pcs.
TP472	Flat Blank	50	51.31
TP478	Flat 1/2" KO	50	75.62
TP476	1/2" Raised	50	92.05
TP475	3/4" Raised	25	464.16
TP479	1" Raised	25	182.73

4" SQUARE CUT TILE WALL COVERS

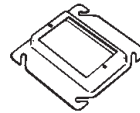

52C4912 or TP520

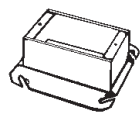

52C50112 or TP528

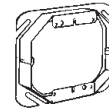

52C512 or TP530

Vendor Code: **TAB** (ABB Installation Products)

Catalog Number	Raised	Ctn. Qty.	Price per 100 pcs.
52C4912	1/2"	50	292.28
52C5011225	1-1/2"	25	277.76
52C51225	2"	25	349.97

Vendor Code: **CRS** (Eaton Crouse-Hinds Series)

Catalog Number	Raised	Ctn. Qty.	Price per 100 pcs.
TP520	1/2"	50	281.26
TP528	1-1/2"	25	267.28
TP530	2"	25	336.76



4" SQUARE SURFACE COVERS

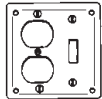

RS2 or TP506

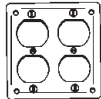

RS8 or TP510

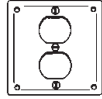

RS12 or TP516



RS11 or TP514

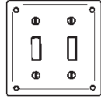

RS5 or TP508



RS9 or TP512



RS4 or TP507

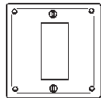

RS16CC or TP513

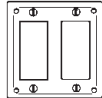

RS17CC or TP511

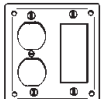

RS19CC or TP517

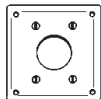

RS13 or TP518

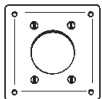

RS14 or TP509

Vendor Code: **TAB** (ABB Installation Products)

Catalog Number	Description	Ctn. Qty.	Price per 100 pcs.
<b>1/2" RAISE</b>			
RS2	1 Toggle, 1 Duplex Receptacle*	50	255.91
RS8	2 Duplex Receptacles*	50	208.99
RS12	1 Duplex Receptacle*	50	176.89
RS11	1 Single Receptacle (1-13/32")	50	234.61
RS5	2 Toggle Switches	50	206.15
RS9	1 Toggle Switch	50	179.96
RS4	4-Wire Twist-Lock Single Receptacle (1-19/32")	50	176.27
RS16CC	1 Decorator Receptacle	25	293.37
RS17CC	2 Decorator Receptacles	25	388.18
RS19CC	1 Decorator Receptacle, 1 Duplex*	25	434.51
RS13	30-50A Single Receptacle (2-5/32")	50	318.51
RS14	30-50-60A Receptacle (2-15/32")	50	179.14

\*Includes Captive Nuts for Receptacles.

Vendor Code: **CRS** (Eaton Crouse-Hinds Series)

Catalog Number	Description	Ctn. Qty.	Price per 100 pcs.
<b>1/2" RAISE</b>			
TP506	1 Toggle, 1 Duplex Receptacle	50	208.18
TP510	2 Duplex Receptacles	50	196.92
TP516	1 Duplex Receptacle	50	166.07
TP514	1 Single Receptacle (1-13/32")	50	190.92
TP508	2 Toggle Switches	50	215.66
TP512	1 Toggle Switch	50	144.83
TP507	1 20 Amp Single Receptacle (1-19/32")	50	176.32
TP513	1 GFCI Receptacle	50	225.81
TP511	2 GFCI Receptacles	50	373.32
TP517	1 Duplex and 1 GFCI Receptacle	50	442.57
TP518	1 30-50 Amp Receptacle (2-9/64")	50	258.82
TP509	1 30-60 Amp Receptacle 4-wire (2-7/16")	50	171.63

UTILITY BOXES

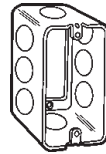

5936112 or TP600

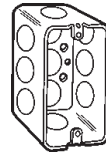

5836112 or TP594

Vendor Code: **TAB** (ABB Installation Products)

Catalog Number	Box Depth	Cubic Inch	Carton Quantity	Price per 100 pcs.
<b>1/2" KO'S</b>				
5836112	1-7/8"	13.0	50	149.25
5837112	2-1/8"	14.5	50	257.34
<b>3/4" KO'S</b>				
5836134	1-7/8"	13.0	50	150.68
5837134	2-1/8"	14.5	50	265.30
<b>EXTENSION RINGS WITH 1/2" KO'S</b>				
5936112	1-7/8"	13.0	50	294.38

Vendor Code: **CRS** (Eaton Crouse-Hinds Series)

Catalog Number	Box Depth	Cubic Inch	Carton Quantity	Price per 100 pcs.
<b>1/2" KO'S</b>				
TP594	1-7/8"	13.0	50	126.17
TP604	2-1/8"	14.5	50	162.33
<b>3/4" KO'S</b>				
TP596	1-7/8"	13.0	50	144.47
TP606	2-1/8"	14.5	50	253.81
<b>EXTENSION RINGS WITH 1/2" KO'S</b>				
TP600	1-7/8"	13.0	50	260.48

UTILITY BOX COVERS



58C1 or TP608



58C7 or TP616

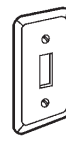

58C30 or TP618

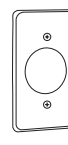

58C4 or TP610

Vendor Code: **TAB** (ABB Installation Products)

Catalog Number	Description	Carton Quantity	Price per 100 pcs.
58C7	Duplex Receptacle	25	78.93
58C30	Toggle Switch	25	72.25
58C1	Blank	25	73.80
58C5	Single Receptacle	25	72.97
58C4	Twist Lock Receptacle	25	113.98
58C6	Blank with 1/2" KO	25	78.27

Vendor Code: **CRS** (Eaton Crouse-Hinds Series)

Catalog Number	Description	Carton Quantity	Price per 100 pcs.
TP616	Duplex Receptacle	100	64.88
TP618	Toggle Switch	100	59.29
TP608	Blank	100	60.81
TP612	Single Receptacle (1-13/32")	100	63.22
TP610	For 20 and 30 Amp, Twist Lock, (1-19/32")	100	90.33
TP614	Blank with 1/2" KO	100	60.22

E Conduit, Fittings & Boxes

4-11/16" SQUARE BOXES



721511234E  
or TP548

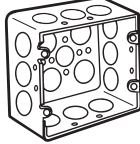

721711234E  
or TP563

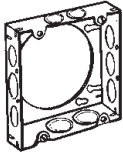

731511234  
or TP550

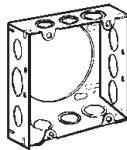

731711234  
or TP564

Vendor Code: **TAB** (ABB Installation Products)

Catalog Number	KO's	Cu. In.	Ctn. Qty.	Price per 100 pcs.
<b>1-1/2" DEEP BOXES</b>				
721511234E	1/2 & 3/4	29.5	20	289.83
<b>2-1/8" DEEP BOXES</b>				
721711234E	1/2 & 3/4	42.0	20	302.11
72171341	3/4 & 1	42.0	20	416.60
721711	1	42.0	20	400.70
72171114	1-1/4	42.0	20	447.69
<b>1-1/2" DEEP EXTENSION RING</b>				
731511234	1/2 & 3/4	29.5	20	683.98
<b>2-1/8" DEEP EXTENSION RING</b>				
731711234	1/2 & 3/4	42.0	20	622.72

Vendor Code: **CRS** (Eaton Crouse-Hinds Series)

Catalog Number	KO's	Cu. In.	Ctn. Qty.	Price per 100 pcs.
<b>1-1/2" DEEP BOXES</b>				
TP548	1/2 & 3/4	29.5	25	267.75
<b>2-1/8" DEEP BOXES</b>				
TP563	1/2 & 3/4	42.0	25	285.62
TP558	3/4 & 1	42.0	25	400.92
TP560	1	42.0	25	410.50
TP562	1-1/4	42.0	25	387.72
<b>1-1/2" DEEP EXTENSION RING</b>				
TP550	1/2 & 3/4	29.5	25	545.20
<b>2-1/8" DEEP EXTENSION RING</b>				
TP564	1/2 & 3/4	42.0	25	599.27



Crouse-Hinds series

4-11/16" SURFACE COVERS

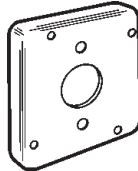

RSL11 or TP724

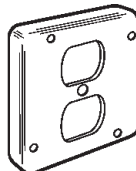

RSL12 or TP722

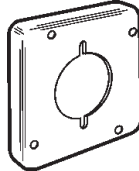

RSL13 or TP732

Vendor Code: **TAB** (ABB Installation Products)

Catalog Number	Description	Ctn. Qty.	Price per 100 pcs.
<b>1/2" RAISE</b>			
RSL12	1 Dup. Rec.	10	547.18
RSL11	1 Sgl. Rec. 1-13/32"	10	558.97
RSL13	30-50A Sgl. Rec. 2-5/32"	10	683.96

Vendor Code: **CRS** (Eaton Crouse-Hinds Series)

Catalog Number	Description	Ctn. Qty.	Price per 100 pcs.
<b>1/2" RAISE</b>			
TP722	1 Dup. Rec.	10	505.98
TP724	1 Sgl. Rec. 1-13/32"	10	529.80
TP732	1 Power Outlet (2-9/64")	10	672.39

4-11/16" BLANK COVERS

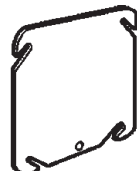

72C1 or TP568



72C6 or TP572

Vendor Code: **TAB** (ABB Installation Products)

Catalog Number	Description	Ctn. Qty.	Price per 100 pcs.
72C1	Flat Blank	50	102.24
72C6	Flat 1/2" KO	50	143.98

Vendor Code: **CRS** (Eaton Crouse-Hinds Series)

Catalog Number	Description	Ctn. Qty.	Price per 100 pcs.
TP568	Flat Blank	25	100.56
TP572	Flat 1/2" KO	25	139.94

4-11/16" DEVICE COVERS



72C13 or TP576



72C1858 or TP587

Vendor Code: **TAB** (ABB Installation Products)

Catalog Number	Raised	Ctn. Qty.	Price per 100 pcs.
<b>SINGLE DEVICE</b>			
72C13	1/2"	25	246.84
72C1458	5/8"	25	233.96
72C14	3/4"	25	210.34
<b>TWO DEVICE</b>			
72C1858	5/8"	25	383.16

Vendor Code: **CRS** (Eaton Crouse-Hinds Series)

Catalog Number	Raised	Ctn. Qty.	Price per 100 pcs.
<b>SINGLE DEVICE</b>			
TP576	1/2"	25	223.60
TP579	5/8"	25	221.71
TP578	3/4"	25	202.42
<b>TWO DEVICE</b>			
TP587	5/8"	25	368.73

MASONRY BOXES

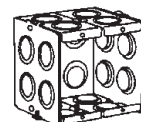

Vendor Code: **TAB** (ABB Installation Products)

Catalog Number	Raised	Ctn. Qty.	Price per 100 pcs.
<b>2-1/2" DEEP - GANGABLE</b>			
GW125G	1 Gang	20	618.58
<b>3-1/2" DEEP - GANGABLE</b>			
GW135G	1 Gang	20	583.03

Vendor Code: **CRS** (Eaton Crouse-Hinds Series)

Catalog Number	Raised	Ctn. Qty.	Price per 100 pcs.
<b>2-1/2" DEEP - GANGABLE</b>			
TP671	1 Gang	20	604.65
<b>3-1/2" DEEP - GANGABLE</b>			
TP675	1 Gang	20	487.60





## Floor Boxes · Recessed Floor Box Cover Kits · Wood Floor Boxes

### FLOOR BOXES

#### NON-METALLIC AND METALLIC

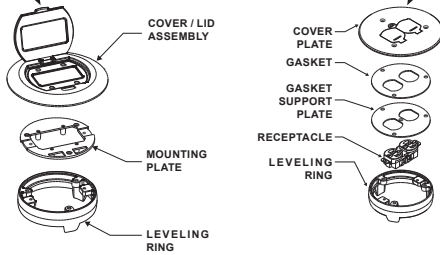

#### FLBC4520BR

Non-Metallic Cover which Includes Plastic Gasketed Cover, Mounting Plate, and Leveling Ring.

#### FLB6230MBLR

Metallic Cover which Includes 6" Brass Round Cover, Two Flip Lids, Gaskets, Receptacle, and Leveling Ring.

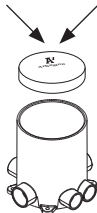

FLBC4502

Vendor Code: **ARL**

Catalog Number	Description	Price Each
<b>FLBC4502*</b>	4-1/2" PVC Box with Divider, Mud Cover, and Additional 3/4" Plugs	14.59
<b>FLBC4502LR</b>	Reversible Adaptor Ring for 3-1/2" and 3-3/8" Hole Pattern if Needed	4.38
<b>NON-METALLIC COVERS</b>		
<b>FLBC4520BR*</b>	6" Round Cover Kit in Brown with Flip Lid, Includes Leveling Ring	21.02
*Other Colors: BR=Brown, W=White, LA=Lt. Almond, GY=Grey, CA=Caramel.		
<b>METALLIC COVERS</b>		
<b>FLBT6615MBLR</b>	6" Brass Trapdoor Cover, Decor Style 15A Pre-Mounted Receptacle	50.98
<b>FLB6230MBLR</b>	6" Brass Flip Lids with Duplex 15A Receptacle	48.96

Leveling Ring Included with All Covers

### METAL FLOOR BOXES

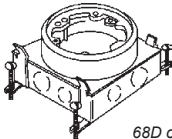

68D or 68S

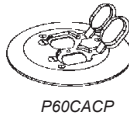

P60CACP

Vendor Code: **TAB**

Catalog Number	Description	Price Each
<b>4-11/16" SQUARE BOX</b>		
<b>68S</b>	1-1/2" Deep	83.76
<b>68D</b>	2-1/8" Deep	94.79
<b>P60CACP</b>	*1-Piece Brass Duplex and Carpet Plate	89.62

\*Uses Standard Duplex Receptacle.

### RECESSED FLOOR BOX COVER KITS IN BOX™ NON-METALLIC AND METALLIC



Cover kits are recessed and install into the can so they look great, and reduce the trip hazard caused by plugs sticking out of the box.

- You can have power and low voltage in the same box.
- In Box Cover Kits are available with metal flanges in brass, or nickel plated brass.
- Plastic covers are available in five colors: light almond, gray, caramel, black, and brown.
- They are easy to install in Arlington's FLBC4502 box.

Vendor Code: **ARL**

Catalog Number	Description	Price Each
<b>IN BOX COVER KITS — NON-METALLIC</b>		
<b>FLBC4560DBL</b>	Black, w/ Black Decorator Style Receptacle	39.72
<b>FLBC4560DCA</b>	Caramel, w/ Dark Brown Decorator Style Receptacle	39.72
<b>FLBC4560DBR</b>	Dark Brown, w/ Dark Brown Decorator Style Receptacle	39.72
<b>FLBC4560DLA</b>	Light Almond, w/ Light Almond Decorator Style Receptacle	39.72
<b>IN BOX COVER KIT — METALLIC</b>		
<b>FLBC4560DMB</b>	Brass Metal Cover with Decorator Style Receptacle	60.83

IN BOX Cover Kits Include: Leveling Ring Assembly (w/ Carpet Flange, Funnel & UL Listed 15 A Decorator Receptacle), Low Voltage Divider, Blank Cover w/ Gasket, In-Use Slotted Cover, Low-Voltage Plug, and #8 x 5/8" Lg. Flat Head Screw

### WOOD FLOOR BOXES

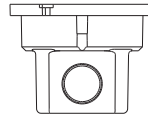

FLB3500

Vendor Code: **ARL**

Catalog Number	Description	Price Each
<b>FLB3500</b>	3.5" Non-Metallic Round Cut-In Box for Existing Wood or Concrete Floors, Black	11.78
<b>FLB4360LA*</b>	Drop-In Floor Box Kit, Light Almond	28.90

\*FLB4360LA Includes: Non-Metallic Cover (Blank), Non-Metallic Gasket Support Plate, Gasket, Carpet Ring, UL Listed 15A TR Duplex Receptacle, Mounting Bracket, NM94 and NM95 Cable Connectors, (3) #8 x 1/2" Flathead Screws, and (1) #6 x 1/2" Screw.



E Conduit, Fittings & Boxes

## Residential Boxes

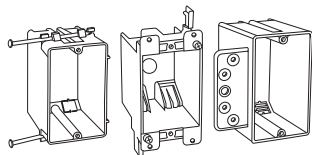
**BOXES**  
**SINGLE GANG**

# ABB

Vendor Code: **TAB**

Catalog Number	Cubic Inch	Type Mounting	Ctn. Qty.	Price per 100 pcs.
<b>PLASTIC</b>				
<b>B118A</b>	18	Nail-On	100	39.65
<b>B120AUPC</b>	20	Nail-On	100	59.44
<b>B122AUPC</b>	22	Nail-On	100	62.53
<b>B114RUPC</b>	14	Pop-In	50	125.06
<b>B118BUPC</b>	18	Bracket	50	189.97



**ALLIED**  
**MOULDED**  
**PRODUCTS, Inc.**
Vendor Code: **ALM**

Catalog Number	Cubic Inch	Type Mounting	Ctn. Qty.	Price per 100 pcs.
<b>FIBERGLASS</b>				
<b>1096N</b>	18	Nail-On	100	52.99
<b>1099N</b>	22.5	Nail-On	100	74.78
<b>9361ES</b>	16	Pop-In	50	218.35

# CANTEX

Vendor Code: **PVF**

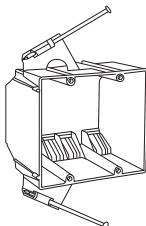
Catalog Number	Cubic Inch	Type Mounting	Ctn. Qty.	Price per 100 pcs.
<b>PLASTIC</b>				
<b>EZ18SN</b>	18	Nail-On	100	41.99
<b>EZ20SN</b>	20	Nail-On	100	51.49
<b>EZ14SO</b>	14	Pop-In	50	155.82

**BOXES**  
**MULTI-GANG**

# ABB

Vendor Code: **TAB**

Catalog Number	Cubic Inch	Type Mounting	Ctn. Qty.	Price per 100 pcs.
<b>PLASTIC, 2 GANG</b>				
<b>B232ACP</b>	32	Nail-On	50	110.84
<b>B225RUPC</b>	25	Pop-In	30	348.96
<b>PLASTIC, 3 GANG</b>				
<b>B344AB</b>	44	Nail-On	30	211.96
<b>PLASTIC, 4 GANG</b>				
<b>B455AUPC</b>	60	Nail-On	25	465.05



**ALLIED**  
**MOULDED**  
**PRODUCTS, Inc.**
Vendor Code: **ALM**

Catalog Number	Cubic Inch	Type Mounting	Ctn. Qty.	Price per 100 pcs.
<b>FIBERGLASS, 2 GANG</b>				
<b>2300N</b>	32.5	Nail-On	48	254.38
<b>FIBERGLASS, 3 GANG</b>				
<b>3300N</b>	46	Nail-On	20	355.57
<b>FIBERGLASS, 4 GANG</b>				
<b>4300N</b>	60	Nail-On	18	534.03

# CANTEX

Vendor Code: **PVF**

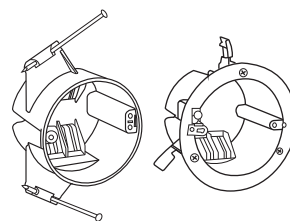
Catalog Number	Cubic Inch	Type Mounting	Ctn. Qty.	Price per 100 pcs.
<b>PLASTIC, 2 GANG</b>				
<b>EZ32DN</b>	32	Nail-On	50	119.99
<b>EZ25D0</b>	25	Pop-In	30	307.40
<b>PLASTIC, 3 GANG</b>				
<b>EZ44TN</b>	44	Nail-On	50	240.60
<b>PLASTIC, 4 GANG</b>				
<b>EZ55QNB</b>	55	Nail-On	25	390.40

**BOXES**  
**ROUND CEILING**

# ABB

Vendor Code: **TAB**

Catalog Number	Cubic Inch	Type Mounting	Ctn. Qty.	Price per 100 pcs.
<b>PLASTIC</b>				
<b>B520AUPC</b>	20	Nail-On	75	138.27
<b>B620K</b>	20	Bar Hanger	75	293.16
<b>B618RUPC</b>	18	Pop-In	100	397.84

**ALLIED**  
**MOULDED**  
**PRODUCTS, Inc.**
Vendor Code: **ALM**

Catalog Number	Cubic Inch	Type Mounting	Ctn. Qty.	Price per 100 pcs.
<b>FIBERGLASS</b>				
<b>9351N</b>	22.5	Nail-On	48	193.97
<b>9351NK</b>	22.5	Nail-On	50	193.97

K=Romex Speed Clamp

# CANTEX

Vendor Code: **PVF**

Catalog Number	Cubic Inch	Type Mounting	Ctn. Qty.	Price per 100 pcs.
<b>PLASTIC</b>				
<b>EZ20CN</b>	20	Nail-On	75	156.96
<b>EZ20CH</b>	20	Bar Hanger	75	316.75
<b>EZ18C0</b>	18	Pop-In	100	244.88



## Weatherproof Boxes · Weatherproof Box Accessories

### WEATHERPROOF BOXES SINGLE GANG

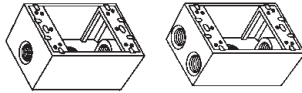

SB350S  
or SB375S

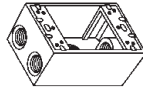

SB450S  
or SB475S

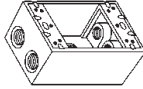

SB550S  
or SB575S

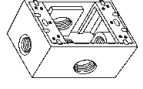

SB550XS  
or SB575XS

Vendor Code: **TAM**

Catalog Number	Outlet Size	Number of Holes	Price per 100 pcs.
<b>3 OUTLETS: 1 IN EACH END, 1 IN BACK</b>			
SB350S*	1/2"	3	417.51
SB375S*	3/4"	3	461.36
<b>4 OUTLETS: 2 IN ONE END, 1 IN OTHER END AND 1 IN BACK</b>			
SB450S*	1/2"	4	511.56
SB475S*	3/4"	4	562.72
<b>5 OUTLETS: 2 IN EACH END, 1 IN BACK</b>			
SB550S	1/2"	5	593.45
SB575S	3/4"	5	654.86
<b>5 OUTLETS: 1 IN EACH END, SIDE AND BACK</b>			
SB550XS	1/2"	5	770.85
SB575XS	3/4"	5	847.91

Catalog Numbers Listed Above are Gray (S).  
\*Replace S with Z for Bronze or WH for White.

### WEATHERPROOF BOXES DEEP

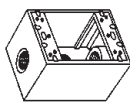

SD375S  
or SB3100S

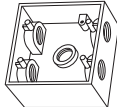

DB5100S

Vendor Code: **TAM**

Catalog Number	Outlet Size	Number of Holes	Price per 100 pcs.
<b>SINGLE GANG W/ 3 OUTLETS: 1 IN EACH END, 1 IN BACK</b>			
SD375S*	3/4"	3	1182.01
SB3100S	1"	3	1220.52
<b>TWO GANG W/ 5 OUTLETS: 2 HOLES IN EACH END, 1 IN BACK</b>			
DB5100S	1"	5	1670.17

Catalog Numbers Listed Above are Gray (S).  
\*Replace S with Z for Bronze or WH for White.

### WEATHERPROOF BOXES TWO GANG

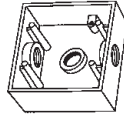

DB350S  
or DB375S

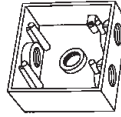

DB450S  
or DB475S

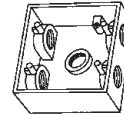

DB550S  
or DB575S

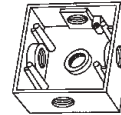

DB550XS  
or DB575XS

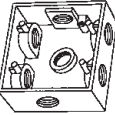

DB750XS  
or DB775SX

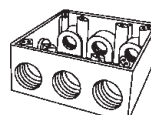

DB750S or  
DB775S

Vendor Code: **TAM**

Catalog Number	Outlet Size	Number of Holes	Price per 100 pcs.
<b>3 OUTLETS</b>			
DB350S*	1/2"	3	1092.05
DB375S*	3/4"	3	1233.35
<b>4 OUTLETS</b>			
DB450S	1/2"	4	1130.59
DB475S	3/4"	4	1400.38
<b>5 OUTLETS: 2 IN EACH SIDE/END</b>			
DB550S	1/2"	5	1259.06
DB575S	3/4"	5	1400.36
<b>5 OUTLETS: 1 IN EACH END/SIDE</b>			
DB550XS	1/2"	5	1541.70
DB575XS	3/4"	5	1541.70
<b>7 OUTLETS: 2 IN EACH END, 1 IN EACH SIDE, 1 IN BACK</b>			
DB750XS	1/2"	7	1670.15
DB775XS	3/4"	7	1670.15
<b>7 OUTLETS: 3 EACH END, 1 IN BACK</b>			
DB750S	1/2"	7	1413.49
DB775S	3/4"	7	1413.49

Catalog Numbers Listed Above are Gray (S).  
\*Replace S with Z for Bronze or WH for White.

### WEATHERPROOF BOXES ACCESSORIES



SE000S



SE450S



CP5050S

Vendor Code: **TAM**

Catalog Number	Description	Price per 100 pcs.
SE000S	1-Gang Extension Ring, No Holes	449.62
DE000S	2-Gang Extension Ring, No Holes	1098.94
SE450S	1-Gang Extension Ring, Four 1/2" Holes	736.66
SE475S	1-Gang Extension Ring, Four 3/4" Holes	767.36
CP450S	4 Pack of 1/2" Closure Plugs	115.63
CP475S	4 Pack of 3/4" Closure Plugs	124.24

Catalog Numbers Listed Above are Gray (S).

### WEATHERPROOF BOXES AND COVERS

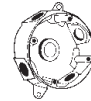

Vendor Code: **TAM**

Catalog Number	Outlet Size	Number of Holes	Price per 100 pcs.
<b>4" ROUND BOXES</b>			
RB550S*	1/2"	5	628.30
RB575S	3/4"	5	867.15
<b>4" ROUND COVERS</b>			
BC300S	-	-	256.92
LV310S	1/2"	1	321.13
LV330S*	1/2"	3	359.75

Catalog Numbers Listed Above are Gray (S).  
\*Replace S with Z for Bronze or WH for White.

### WEATHERPROOF LAMP HOLDERS AND LAMP COVERS

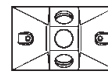

LV130S



LT100S

Vendor Code: **TAM**

Catalog Number	Description	Price per 100 pcs.
<b>OUTDOOR LAMP COVERS FOR SINGLE GANG</b>		
LV110S	1 Hole Lamp Plate	308.30
LV130S	3 Hole Lamp Plate	372.55
<b>DIE-CAST OUTDOOR LAMP HOLDER</b>		
LT100S	Lamp Holder	359.23

Catalog Numbers Shown are Gray (S).  
Replace S with Z for Bronze or WH for White.

**E**  
Conduit, Fittings & Boxes



Weatherproof Box Covers · While-In-Use Covers

SINGLE GANG COVERS



BC100S CH100S TC100S

- Superior commercial quality die cast metal construction
- Premium powdercoat finish
- Includes gasket, mounting hardware and installation instructions
- UL listed and 2011 NEC and NEMA 3R compliant

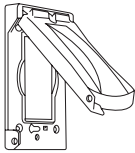

MX1050S  
(Single Gang 12 in 1 Cover)

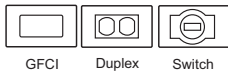
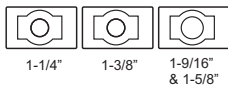
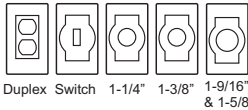
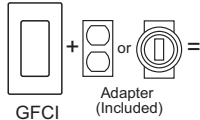

Vendor Code: **TAM**

Catalog Number	Description	Ctn. Qty.	Price per 100 pcs.
<b>BLANK COVER</b>			
BC100S	Die Cast Blank Cover	20	115.33
<b>TOGGLE SWITCH COVER</b>			
TC100S	Die Cast Toggle Cover	10	513.88
<b>DUPLEX RECEPTACLE COVER</b>			
CH100S	Horizontal, Lockable	20	423.93
<b>MX SERIES, 12 IN 1 COVERS</b>			
MX1050S	Vertical/Horizontal	20	537.12
MX1250S	Horizontal/Vertical	20	539.57

Catalog Numbers Listed Above are Gray (S).  
Replace S with Z for Bronze or WH for White.

TWO GANG COVERS

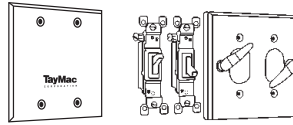

BC200S TC221S

- Superior commercial quality die cast metal construction
- Premium powdercoat finish
- Includes gasket, mounting hardware and installation instructions
- UL listed and 2011 NEC and NEMA 3R Compliant

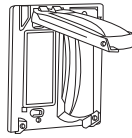

MX2050S  
(Two Gang 25 in 1 Cover)

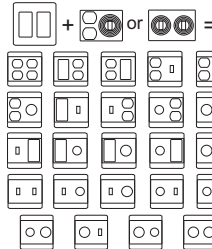

Vendor Code: **TAM**

Catalog Number	Description	Ctn. Qty.	Price per 100 pcs.
<b>2 GANG COVERS</b>			
BC200S	Blank Cover	20	206.59
TC221S	Toggle Cover Kit with Switches	4	1095.67
MX2050S	2-Device, 25 in 1	9	1477.45

Catalog Numbers Listed Above are Gray (S).

OUTDOOR RECESSED WALL OUTLET ENCLOSURE

Vendor Code: **TAM**

Catalog Number	Description	Price Each
MR420CG	6-in-1 Weather Proof In-Use Cover	30.18

Catalog Number Listed Above is Gray (G).  
Replace G with Z for Bronze or W for White.



WHILE-IN-USE COVERS

EXTRA DUTY COVERS  
(see below)

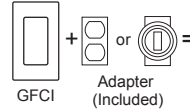

- Mounted horizontally or vertically
- Inserts allow 16 combinations
- Single and two gang models
- Quick-Fit (keyed mount) installation
- Locking feature (single gang models)
- Available in clear, white and grey finishes
- Made in the U.S.A.
- New Extra Duty adheres to NEC 2014

Vendor Code: **TAM**

Catalog Number	Depth	Width	Ctn. Qty.	Price Each
<b>1-GANG COVERS</b>				
MM110C	5/8"	2-3/8"	20	7.41
MM410C	2-3/4"	2-3/8"	10	12.29
MM710C	4-3/4"	2-3/8"	5	19.53
<b>2-GANG COVERS</b>				
MM1410C	5/8"	2"	10	10.56
MM2410C	2-3/4"	2"	6	22.07
MM7440CB	4-3/4"	2"	3	31.86
<b>EXTRA DUTY COVERS 1-GANG</b>				
MM420C	2-3/4"	2-3/8"	10	14.29

Single Gang Includes Cover, Base and 1 Adaptor. Adaptor Can Be Used for Duplex, GFCI, Switch, 1-3/8" Round, 1-5/8" Round, 1-3/4" Round, 2-1/4" Round for Horizontal and Vertical Mounts.

2 Gang Includes Cover, Base and 4 Adaptors. Adaptor Can Be Used for Duplex, GFCI, Switch, 1-3/8" Round, 1-5/8" Round, 1-3/4" Round, 2-1/4" Round, and 2-5/8" Round.

**Extra Duty:** Changes for NEC 2014  
An outlet box hood installed for this purpose shall be listed and shall be identified as "extra-duty." (Referenced from 406.9 Receptacles in Damp or Wet Locations)

WEATHERPROOF COVER  
LOW PROFILE WHILE IN-USE

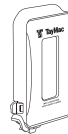

Vendor Code: **TAM**

Catalog Number	Description	Price Each
ML450G	16-in-1 Flat Expandable	14.43

Catalog Number Listed Above is Gray (G).  
Replace G with Z for Bronze or W for White.

E

Conduit, Fittings & Boxes



## Weatherproof Boxes · Weatherproof Box Accessories

### WEATHERPROOF BOXES SINGLE GANG

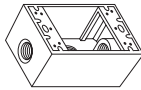

WPB23  
or WPB33

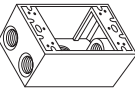

WPB24  
or WPB34

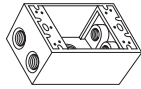

WPB25  
or WPB35



WPB26  
or WPB36

Vendor Code: **PAS**

Catalog Number	Outlet Size	Number of Holes	Price per 100 pcs.
<b>3 OUTLETS: 1 IN EACH END, 1 IN BACK</b>			
WPB23*	1/2"	3	331.02
WPB33*	3/4"	3	371.24
<b>4 OUTLETS: 2 IN ONE END, 1 IN OTHER END AND 1 IN BACK</b>			
WPB24	1/2"	4	497.22
WPB34	3/4"	4	520.80
<b>5 OUTLETS: 2 IN EACH END, 1 IN BACK</b>			
WPB25	1/2"	5	601.97
WPB35	3/4"	5	687.24
<b>5 OUTLETS: 1 IN EACH END, SIDE AND BACK</b>			
WPB26	1/2"	5	660.79
WPB36	3/4"	5	721.69

Catalog Numbers Listed Above are Gray.  
\*Add Suffix **BR** for Bronze or **W** for White.

### WEATHERPROOF BOXES DEEP

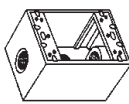

WPBD33  
or WPBD43

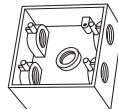

WPBD452

Vendor Code: **PAS**

Catalog Number	Outlet Size	Number of Holes	Price per 100 pcs.
<b>SINGLE GANG 3: 1 IN EACH END, 1 IN BACK</b>			
WPBD33	3/4"	3	992.60
WPBD43	1"	3	1031.91
<b>TWO GANG 5: 2 IN EACH END, 1 IN BACK</b>			
WPBD452	1"	5	1396.47

### WEATHERPROOF BOXES TWO GANG

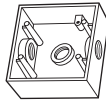

WPB232  
or WPB332

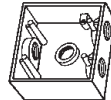

WPB242  
or WPB342

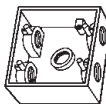

WPB252  
or WPB352

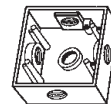

WPB262  
or WPB362

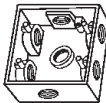

WPB282  
or WPB382

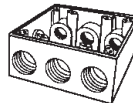

WPB287  
or WPB387

Vendor Code: **PAS**

Catalog Number	Outlet Size	Number of Holes	Price per 100 pcs.
<b>3 OUTLETS</b>			
WPB232*	1/2"	3	922.21
WPB332	3/4"	3	1048.70
<b>4 OUTLETS</b>			
WPB242	1/2"	4	961.16
WPB342*	3/4"	4	1144.43
<b>5 OUTLETS: 2 IN EACH SIDE/END</b>			
WPB252	1/2"	5	1051.32
WPB352	3/4"	5	1195.87
<b>5 OUTLETS: 1 IN EACH END/SIDE</b>			
WPB262	1/2"	5	1226.22
WPB362	3/4"	5	1297.95
<b>7 OUTLETS: 2 IN EACH END, 1 IN EACH SIDE, 1 IN BACK</b>			
WPB282	1/2"	7	1284.72
WPB382	3/4"	7	1333.32
<b>7 OUTLETS: 3 EACH END, 1 IN BACK</b>			
WPB287	1/2"	7	1277.76
WPB387	3/4"	7	1333.32

Catalog Numbers Listed Above are Gray.  
\*Add Suffix **W** for White.

### WEATHERPROOF BOXES ACCESSORIES



WPEX1



WPEX4



WPBP50

Vendor Code: **PAS**

Catalog Number	Description	Price per 100 pcs.
WPEX1	1-Gang Extension Ring	378.84
WPEX2	2-Gang Extension Ring	808.60
WPEX4	1 Gang Extension Ring with Four 1/2" Hubs and Two 1/2" Plugs	755.54
WPEX6	1 Gang Extension Ring with Four 3/4" Hubs and Two 3/4" Plugs	777.77
WPBP50CC	Closure Plug - 1/2"	86.89
WPBP75CC	Closure Plug - 3/4"	126.19

### WEATHERPROOF BOXES AND COVERS

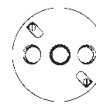
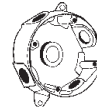

Vendor Code: **PAS**

Catalog Number	Outlet Size	Number of Holes	Price per 100 pcs.
<b>4" ROUND BOXES</b>			
WPBR25	1/2"	5	492.84
WPBR35	3/4"	5	599.97
<b>4" ROUND OUTDOOR CLUSTER COVERS</b>			
WPBR1*	-	-	214.28
WPBR11	1/2"	1	266.96
WPBR13	1/2"	3	293.51

\*Blank Cover

### WEATHERPROOF LAMP HOLDERS AND LAMP COVERS

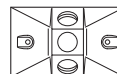

WPB13



PAR1

Vendor Code: **PAS**

Catalog Number	Description	Price per 100 pcs.
<b>OUTDOOR LAMP COVERS FOR SINGLE GANG</b>		
WPB11	1 Hole Lamp Plate	255.83
WPB13*	3 Hole Lamp Plate	311.42
<b>DIE-CAST OUTDOOR LAMP HOLDER</b>		
PAR1*	Lampholder	288.87

Catalog Numbers Listed Above are Gray.  
\*Add Suffix **BR** for Bronze or **W** for White.



**E**  
Conduit, Fittings & Boxes

Weatherproof Box Covers

SINGLE GANG COVERS

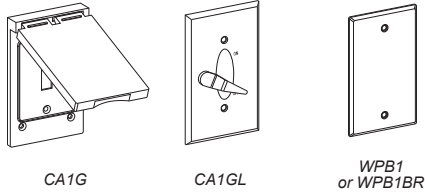

DUPLEX RECEPTACLE COVERS

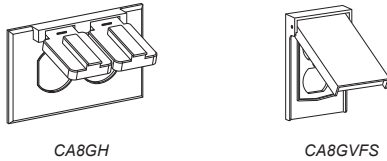

GFCI/DECO COVERS

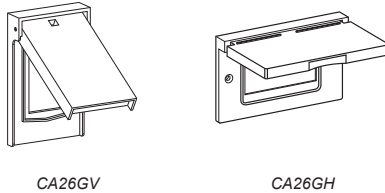

TWO GANG COVERS

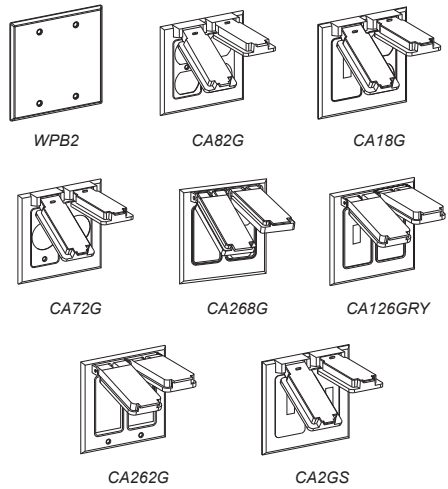

Vendor Code: PAS

Catalog Number	Description	Carton Quantity	Price per 100 pcs.
<b>2 GANG COVERS</b>			
WPB2	Blank w/Gasket	10	151.97
CA82G	1 Duplex	12	1218.91
CA18G	1 Tog/1 Duplex	24	1269.99
CA262G	2 GFCI or Deco	12	1218.91
CA2GS	2 Toggle Switches	12	932.97
CA268G	1 GFCI or Deco/1 Duplex	12	1218.91
CA72G	2 Single Rec.	24	1218.91
CA126GRY	1 Toggle/1 Deco	12	1218.91

Catalog Numbers Listed Above are Gray.

Vendor Code: PAS

Catalog Number	Description	Carton Quantity	Price per 100 pcs.
<b>SINGLE GANG BLANK COVERS</b>			
WPB1	Grey Cover	20	93.71
WPB1BR	Bronze Cover	20	93.71
WPB1W	White Cover	20	93.28
<b>SINGLE GANG TOGGLE SWITCH COVERS</b>			
CA1G	Vertical Switch Cover	10	434.68
CA1GL	Vertical Switch w/Handle	8	434.02
<b>DUPLEX RECEPTACLE COVERS</b>			
CA8GH	Grey Horizontal 2 Lid	12	377.76
CA8GVFS	Grey Vertical 1 Lid	14	434.02
CA8WH	White Horizontal 2 Lid	14	434.02
<b>SINGLE GANG GFCI/DECO, 1 LID</b>			
CA26GV	Grey Vertical GFCI	14	429.39
CA26GH	Grey Horizontal GFCI	14	429.39
CA26BRV	Bronze Vertical GFCI	14	429.39
CA26BRH	Bronze Horizontal GFCI	14	429.39
CA26WH	White Horizontal GFCI	14	429.39
CA26WV	White Vertical GFCI	14	429.39
<b>SINGLE GANG POWER OUTLET VERTICAL W/1 LID</b>			
CA7GV	15 & 20A Str. Rec., (1-13/32")	10	445.15
CA723G	30 & 50A Range & Dryer, (1-5/8")	14	443.23
CA721G	20 & 30A Turnlok, (1-3/4")	24	443.23

WEATHERPROOF COVERS  
THERMOPLASTIC FOR FLANGED INLET/OUTLET



Vendor Code: PAS

Catalog Number	Description	Price per 100 pcs.
WPG1	Accommodates 15/20A Straight Blade, 15A Turnlok®	4483.34
WPG2	Accommodates 20/30A Turnlok®	5222.64



E

Conduit, Fittings & Boxes



F

Enclosures & Wireway

SECTION



Enclosures & Wireway



Enclosures & Wireway

Enclosures & Wireway

Enclosures

B-Line Series.....	F3-F4
Hoffman.....	F6-F7

Wireways

B-Line Series.....	F5
Hoffman.....	F8







## Eaton B-Line Series (Single Door Wall Mount - Junction Boxes)

### HEAVY DUTY SINGLE DOOR WALL MOUNT NEMA 12 & 13 ENCLOSURES

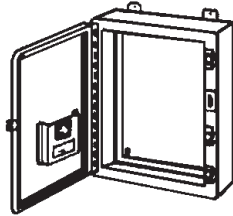

#### APPLICATIONS

For use in housing electrical and electronic controls, instruments, components, and associated wiring, these enclosures incorporate hinged doors that provide convenient access. Designed for indoor use in protecting components from dirt, dust, oil and water.

#### CONSTRUCTION

- Seams continuously welded and ground smooth
- Doors are secured to the body with a heavy-duty continuous hinge on one side and easy-to-release door clamps mounted to the opposite side
- Each door has a padlock hasp with sealing hole provision
- Door has a fixed, oil-resistant gasket
- Formed lip around enclosure opening diverts liquids and contaminants
- Ground stud provided on door
- Print pocket provided
- .375-16 collar studs are provided for mounting optional panel
- External mounting feet are provided for secure wall mounting

#### FINISH

- Wash and phosphate undercoat
- ANSI 61 gray polyester powder outside with a white polyester powder finish inside

Vendor Code: **BLI**

Catalog Number	Dimensions			Back Panel*	Price Each
	H	W	D		
1616612	16"	16"	6"	AW1616P	478.90
2016812	20"	16"	8"	AW2016P	541.66
2020612	20"	20"	6"	AW2020P	553.64
2020812	20"	20"	8"	AW2020P	584.90
2420812	24"	20"	8"	AW2420P	448.98
2424812	24"	24"	8"	AW2424P	678.50
24241212	24"	24"	12"	AW2424P	753.00
36361212	36"	36"	12"	AW3636P	818.82

\*See Page F4 for Back Panel Selection, Sold Separately.

### STANDARD DUTY JUNCTION BOXES NEMA 12 & 13 ENCLOSURES

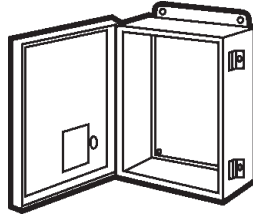

#### APPLICATIONS

Designed for use as electrical junction boxes, terminal wiring boxes, and instrument housings. Provides protection from circulating dust, falling dirt, and dripping non-corrosive liquids.

#### CONSTRUCTION

- Enclosure and cover are fabricated from 16 gauge steel
- Seams continuously welded and ground smooth
- Cover is secured to the body with a continuous hinge on one side and easy-to-operate screw clamps mounted to the opposite side
- Cover has fixed, oil-resistant gasket
- Ground stud provided on cover
- #10-32 weldnuts are provided for mounting optional panel on 6" H x 4" W and larger enclosures
- External mounting feet are provided for secure wall mounting

#### FINISH

- Wash and phosphate undercoat
- ANSI 61 gray polyester powder finish
- Hardware and clamps are zinc plated with a yellow chromate finish

Vendor Code: **BLI**

Catalog Number	Dimensions			Back Panel*	Price Each
	H	W	D		
66412CHC	6"	6"	4"	AW66P	65.73
863.512CHC	8"	6"	3.5"	AW86P	69.86
86612CHC	8"	6"	6"	AW86P	115.98
88412CHC	8"	8"	4"	AW88P	110.96
108412CHC	10"	8"	4"	AW108P	121.34
108612CHC	10"	8"	6"	AW108P	97.75
1210512CHC	12"	10"	5"	AW1210P	155.36
1210812CHC	12"	10"	8"	AW1210P	189.22
1212612CHC	12"	12"	6"	AW1212P	128.99
1412612CHC	14"	12"	6"	AW1412P	140.18
1412812CHC	14"	12"	8"	AW1412P	225.00
1614612CHC	16"	14"	6"	AW1614P	165.09
1614812CHC	16"	14"	8"	AW1614P	183.10

\*See Page F4 for Back Panel Selection, Sold Separately.

### JUNCTION BOXES NEMA 4 ENCLOSURES

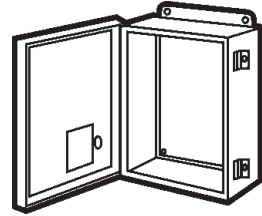

#### APPLICATIONS

Intended for indoor or outdoor use as electrical junction boxes, terminal wiring boxes, and instrument housings. Hinged doors provide convenient access. Suitable for indoor or outdoor use, wherever protection from dust, dirt, oil, or hose directed water is essential.

#### CONSTRUCTION

- Enclosure and cover are fabricated from 16 gauge steel
- Seams continuously welded and ground smooth
- Cover is secured to the body with a continuous hinge on one side and easy-to-operate stainless steel screw clamps mounted to the opposite side
- Cover has a fixed, oil and water resistant gasket
- Ground stud provided on cover
- Stainless steel hinge pin
- #10-32 weldnuts are provided for mounting optional panel on 6" H x 4" W and larger enclosures
- External mounting feet are provided for secure wall mounting

#### FINISH

- Wash and phosphate undercoat
- ANSI 61 gray polyester powder finish

Vendor Code: **BLI**

Catalog Number	Dimensions			Back Panel*	Price Each
	H	W	D		
6644CHC	6"	6"	4"	AW66P	93.50
10864CHC	10"	8"	6"	AW108P	200.56
121054CHC	12"	10"	5"	AW1210P	157.77
121264CHC	12"	12"	6"	AW1212P	166.15
141264CHC	14"	12"	6"	AW1412P	278.28
161464CHC	16"	14"	6"	AW1614P	327.40

\*See Page F4 for Back Panel Selection, Sold Separately.

F Enclosures & Wireway

# EATON

## B-Line series



BACK PANELS FOR ENCLOSURES

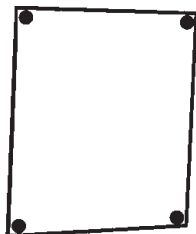

Vendor Code: BLI

Catalog Number	Fits Enclosure		Price Each
	Height	Width	
AW66P	6"	6"	8.06
AW86P	8"	6"	6.61
AW88P	8"	8"	7.78
AW108P	10"	8"	8.97
AW1010P	10"	10"	10.67
AW1210P	12"	10"	12.16
AW1212P	12"	12"	14.30
AW1412P	14"	12"	15.85
AW1614P	16"	14"	21.00
AW1616P	16"	16"	37.48
AW2016P	20"	16"	44.58
AW2020P	20"	20"	54.08
AW2420P	24"	20"	69.65
AW2424P	24"	24"	80.22
AW3024P	30"	24"	96.63
AW3630P	36"	30"	154.33
AW3636P	36"	36"	181.33

OIL-TIGHT HOLE SEALS

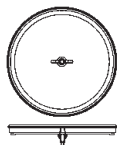

Vendor Code: BLI

Catalog Number	Description	Price Each
S050	1/2" Oil-Tight Hole Seal	8.08
S075	3/4" Oil-Tight Hole Seal	10.22
S100	1" Oil-Tight Hole Seal	10.40
S125	1-1/4" Oil-Tight Hole Seal	15.66
S150	1-1/2" Oil-Tight Hole Seal	17.86
S200	2" Oil-Tight Hole Seal	19.64
S250	2-1/2" Oil-Tight Hole Seal	18.18
S300	3" Oil-Tight Hole Seal	34.30
S400	4" Oil-Tight Hole Seal	55.02
SPB	30.5 mm Pushbutton Hole Seal	7.97

**EATON**  
B-Line series

PREMIER ENCLOSURES

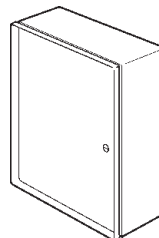

APPLICATIONS

- Houses electrical controls and instruments in a contemporary streamlined design
- Premier series enclosures offer increased flexibility and improved features suitable for any high-tech or standard installation
- Intended for indoor or outdoor use
- Protects against circulating and windblown dust, falling dirt, dripping noncorrosive liquids, rain, splashing water and hose directed water

BODY CONSTRUCTION

- Body flange trough design, formed around body opening, diverts liquid contaminants away from door opening
- Reduced width flange design increases enclosure opening
- Ground stud provided in enclosure body
- .312-18 collar studs are provided for mounting optional Premier panels
- Enclosure mounting holes in body provided for direct mounting or optional mounting feet
- Utility bracket provides wire management and accessory mounting

DOOR CONSTRUCTION

- Doors are secured to the body with a unique spring-loaded hidden hinge design on one side and slotted quarter-turn flush latch(es) on opposite side
- Doors are easily removed and interchangeable
- Door has a fixed, oil and water-resistant, seamless foam in-place gasket
- Door opens 170° for easy access
- Utility rail provides grounding, rigidity and wire management
- Door stiffeners are provided on larger enclosures for added rigidity
- Window-door enclosures feature flush-mounted clear polycarbonate window

ENCLOSURES

Vendor Code: BLI

Catalog Number	Dimensions			Use With Back Panel <i>(see below)</i>	Price Each
	H	W	D		
20166SD	20"	16"	6"	2016P	310.14
24208SD	24"	20"	8"	2420P	508.92
30248SD	30"	24"	8"	3024P	631.30
36248SD	36"	24"	8"	3624P	693.66
363610SD	36"	36"	10"	3636P	890.30

BACK PANELS

Vendor Code: BLI

Catalog Number	Dimensions		Price Each
	Height	Width	
2016P	18"	14"	48.19
2420P	22"	18"	74.17
3024P	28"	22"	144.64
3624P	34"	22"	120.94
3636P	34"	34"	261.78

F

Enclosures & Wireway



## SCREW COVER PULL BOXES

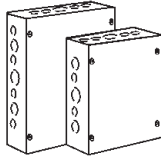

Vendor Code: **BLI**

Catalog Number	Dimensions			Price Each
	H	W	D	
<b>PAINTED WITH KNOCKOUTS</b>				
<b>444SC</b>	4"	4"	4"	10.08
<b>664SC</b>	6"	6"	4"	12.86
<b>666SC</b>	6"	6"	6"	15.66
<b>884SC</b>	8"	8"	4"	17.82
<b>886SC</b>	8"	8"	6"	21.38
<b>10104SC</b>	10"	10"	4"	23.08
<b>10106SC</b>	10"	10"	6"	27.34
<b>12124SC</b>	12"	12"	4"	29.62
<b>12126SC</b>	12"	12"	6"	34.74
<b>18186SC</b>	18"	18"	6"	63.10
<b>24246SC</b>	24"	24"	6"	127.92

## RAINTIGHT SCREW COVER PULL BOXES

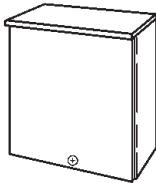

Vendor Code: **BLI**

Catalog Number	Dimensions			Price Each
	H	W	D	
<b>PAINTED WITH KNOCKOUTS</b>				
<b>444RTSC</b>	4"	4"	4"	17.84
<b>664RTSC</b>	6"	6"	4"	22.38
<b>666RTSC</b>	6"	6"	6"	23.68
<b>884RTSC</b>	8"	8"	4"	29.58
<b>886RTSC</b>	8"	8"	6"	34.70
<b>10104RTSC</b>	10"	10"	4"	37.94
<b>10106RTSC</b>	10"	10"	6"	44.50
<b>12124RTSC</b>	12"	12"	4"	47.70
<b>12126RTSC</b>	12"	12"	6"	54.68
<b>18186RTSC</b>	18"	18"	6"	111.86
<b>18188RTSCNK</b>	18"	18"	8"	99.48
<b>24248RTSC</b>	24"	24"	8"	150.32
<b>242412RTSC</b>	24"	24"	12"	178.21

See Page F3 for NEMA Type 4, 12, and 13 Enclosures.

## HINGED LAY-IN INDOOR WIREWAYS

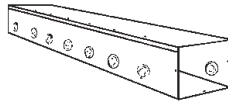

4" X 4"

Vendor Code: **BLI**

Catalog Number	Length	Price Each
<b>4412HS</b>	12"	14.92
<b>4424HS</b>	24"	26.32
<b>4436HS</b>	36"	37.00
<b>4448HS</b>	48"	49.44
<b>4460HS</b>	60"	52.72

6" X 6"

Vendor Code: **BLI**

Catalog Number	Length	Price Each
<b>6612HS</b>	12"	29.50
<b>6624HS</b>	24"	39.28
<b>6636HS</b>	36"	52.84
<b>6648HS</b>	48"	71.38
<b>6660HS</b>	60"	77.52

8" X 8"

Vendor Code: **BLI**

Catalog Number	Length	Price Each
<b>8824HSNK</b>	24"	75.40
<b>8836HSNK</b>	36"	115.66
<b>8848HSNK</b>	48"	99.86
<b>8860HSNK</b>	60"	157.54

## COUPLINGS AND ENDS



Couplings



Ends

Vendor Code: **BLI**

Catalog Number	Size	Price Each
<b>COUPLINGS</b>		
<b>44C</b>	4" x 4"	4.76
<b>66C</b>	6" x 6"	7.10
<b>88C</b>	8" x 8"	9.54
<b>END PLATES</b>		
<b>44E</b>	4" x 4"	3.40
<b>66E</b>	6" x 6"	5.01
<b>88E</b>	8" x 8"	6.75

## SCREW COVER RAIN-TIGHT WIREWAYS

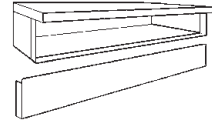

4" X 4"

Vendor Code: **BLI**

Catalog Number	Length	Price Each
<b>4412GRTNK</b>	12"	38.56
<b>4424GRTNK</b>	24"	61.70
<b>4436GRTNK</b>	36"	63.95
<b>4448GRTNK</b>	48"	78.58

6" X 6"

Vendor Code: **BLI**

Catalog Number	Length	Price Each
<b>6612GRTNK</b>	12"	45.01
<b>6624GRTNK</b>	24"	84.40
<b>6636GRTNK</b>	36"	89.04
<b>6648GRTNK</b>	48"	138.92
<b>6660GRTNK</b>	60"	166.40
<b>6672GRTNK</b>	72"	154.29

8" X 8"

Vendor Code: **BLI**

Catalog Number	Length	Price Each
<b>8824GRTNK</b>	24"	112.68
<b>8836GRTNK</b>	36"	120.10
<b>8848GRTNK</b>	48"	150.16
<b>8860GRTNK</b>	60"	180.46
<b>8872GRTNK</b>	72"	247.07

# EATON

## B-Line series



**HEAVY DUTY SINGLE DOOR WALL MOUNT NEMA 12 & 13 ENCLOSURES**

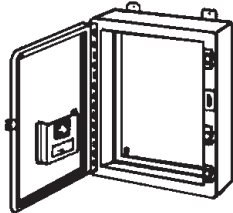

**APPLICATIONS**

For use in housing electrical and electronic controls, instruments, components, and associated wiring, these enclosures incorporate hinged doors that provide convenient access. Designed for indoor use in protecting components from dirt, dust, oil and water.

**CONSTRUCTION**

- Seams continuously welded and ground smooth, no holes or knockouts.
- Rolled flanges around three sides of door and all sides of enclosure opening excludes liquids and contaminants
- Newly designed door clamps are quick and easy to operate
- Oil resistant gasket attached with oil resistant adhesive
- External wall mounting brackets
- Removable heavy gauge continuous hinge pin
- Hasp and staple for padlocking
- Data pocket on inside of door is high impact thermoplastic
- Bonding provision on door
- White inside with ANSI 61 gray polyester powder paint outside
- Optional panels are white, 12 gauge steel

**INDUSTRY STANDARDS**

UL 508A, File No. E61997; Type 12 & 13  
NEMA/IEEMAC Type 12 & 13  
JIC Standard EGP-1-1967 (14 gauge only)  
CSA File #LR42186, Type 12  
IEC 60529, IP65

Vendor Code: **HOF**

Catalog Number	Dimensions			Back Panel*	Price Each
	H	W	D		
A161606LP	16"	16"	6"	A16P16	363.00
A161608LP	16"	16"	8"	A16P16	382.00
A201608LP	20"	16"	8"	A20P16	478.33
A202006LP	20"	20"	6"	A20P20	420.00
A202008LP	20"	20"	8"	A20P20	443.00
A242008LP	24"	20"	8"	A24P20	555.33
A242408LP	24"	24"	8"	A24P24	514.00
A242410LP	24"	24"	10"	A24P24G	542.00
A242412LP	24"	24"	12"	A24P24	570.00
A363010LP	36"	30"	10"	A36P30	868.00
A363612LP	36"	36"	12"	A36P36	869.00

\*See Page F7 for Back Panel Selection, Sold Separately.

**STANDARD DUTY JUNCTION BOXES NEMA 12 & 13 ENCLOSURES**

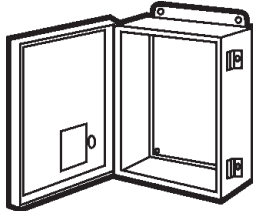

**APPLICATIONS**

Designed for use as electrical junction boxes, terminal wiring boxes, and instrument housings. Provides protection from circulating dust, falling dirt, and dripping non-corrosive liquids.

**CONSTRUCTION**

- Seams continuously welded and ground smooth, no holes or knockouts
- External screw clamps are quick and easy to operate
- Oil resistant gasket attached with oil resistant adhesive
- External wall mounting brackets
- Continuous hinge
- Bonding provision on door
- ANSI 61 gray polyester powder paint inside and out
- Optional panels are white

**INDUSTRY STANDARDS**

UL 50, File No. E27567; Type 12 & 13  
NEMA/IEEMAC Type 12 & 13  
JIC Standard EGP-1-1967 (14 gauge only)  
CSA File #LL42184, Type 12 & 13  
IEC 60529, IP65

Vendor Code: **HOF**

Catalog Number	Dimensions			Back Panel*	Price Each
	H	W	D		
A606CH**	6"	6"	4"	A6P6	70.57
A806CH	8"	6"	3.5"	A8P6	75.00
A8066CH	8"	6"	6"	A8P6	89.01
A808CH	8"	8"	4"	A8P8	85.30
A1008CH	10"	8"	4"	A10P8	93.18
A10086CH	10"	8"	6"	A10P8	106.00
A10106CH	10"	10"	6"	A10P10	116.00
A1210CH	12"	10"	5"	A12P10	120.00
A12108CH	12"	10"	8"	A12P10	146.00
A1212CH	12"	12"	6"	A12P12	139.00
A1412CH	14"	12"	6"	A14P12	151.00
A14128CH	14"	12"	8"	A14P12	173.00
A1614CH	16"	14"	6"	A16P14	178.00
A16148CH	16"	14"	8"	A16P14	197.00

\*See Page F7 for Back Panel Selection, Sold Separately.

\*\*A606CH is 16 Gauge. All Others Listed are 14 Gauge.

**JUNCTION BOXES NEMA 4 ENCLOSURES**

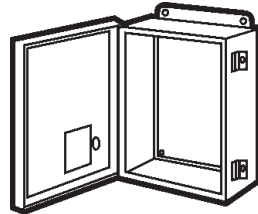

**APPLICATIONS**

Intended for indoor or outdoor use as electrical junction boxes, terminal wiring boxes, and instrument housings. Hinged doors provide convenient access. Suitable for indoor or outdoor use, wherever protection from dust, dirt, oil, or hose directed water is essential.

**CONSTRUCTION**

- Seams continuously welded and ground smooth, no holes or knockouts
- Stainless steel clamps on three sides of door assure watertight seal
- Door removed by pulling stainless steel hinge pin
- Oil resistant gasket attached with oil resistant adhesive
- External wall mounting brackets
- Heavy gauge continuous hinge
- Bonding provision on door
- ANSI 61 gray polyester powder paint inside and out
- Optional panels are white

**INDUSTRY STANDARDS**

UL 50, File No. E27567; Type 4, 12 & 13  
NEMA/IEEMAC Type 4, 12 & 13  
JIC Standard EGP-1-1967 (14 gauge only)  
CSA File #LL42184, Type 4, 12 & 13  
IEC 60529, IP65

Vendor Code: **HOF**

Catalog Number	Dimensions			Back Panel*	Price Each
	H	W	D		
A606CHNF	6"	6"	4"	A6P6	99.57
A10086CHNF	10"	8"	6"	A10P8	153.00
A1210CHNF	12"	10"	5"	A12P10	169.00
A1212CHNF	12"	12"	6"	A12P12	177.00
A1412CHNF	14"	12"	6"	A14P12	212.00
A1614CHNF	16"	14"	6"	A16P14	292.51

\*See Page F7 for Back Panel Selection, Sold Separately.



**HOFFMAN**



### BACK PANELS FOR ENCLOSURES

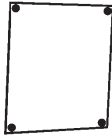

Vendor Code: **HOF**

Catalog Number	Fits Enclosure		Price Each
	Height	Width	
A6P6	6"	6"	5.88
A8P6	8"	6"	6.70
A8P8	8"	8"	7.80
A10P8	10"	8"	9.10
A10P10	10"	10"	10.70
A12P10	12"	10"	12.30
A12P12	12"	12"	14.40
A12N12P	12"	12"	13.20
A14P12	14"	12"	16.00
A16P14	16"	14"	21.19
A16P16	16"	16"	39.71
A18P16	18"	16"	29.69
A20P16	20"	16"	47.09
A20P20	20"	20"	56.87
A24P20	24"	20"	73.61
A24P24	24"	24"	84.70
A30P24	30"	24"	103.00
A36P30	36"	30"	164.00
A36P36	36"	36"	193.00

### OIL-TIGHT HOLE SEALS

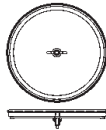

Vendor Code: **HOF**

Catalog Number	Description	Price Each
AS050	1/2" Oil-Tight Hole Seal	8.07
AS075	3/4" Oil-Tight Hole Seal	10.19
AS100	1" Oil-Tight Hole Seal	14.06
AS125	1-1/4" Oil-Tight Hole Seal	15.59
AS150	1-1/2" Oil-Tight Hole Seal	17.91
AS200	2" Oil-Tight Hole Seal	19.60
AS250	2-1/2" Oil-Tight Hole Seal	25.00
AS300	3" Oil-Tight Hole Seal	32.99
AS400	4" Oil-Tight Hole Seal	54.80
ASPB	30.5 mm Pushbutton Hole Seal	10.97

### THERMAL MANAGEMENT

Hoffman® SpectraCool™ Series feature a wide range of cooling capacities for indoor, outdoor, and harsh environments. Please see your local Elliott Electric Supply for details.



### PREMIER ENCLOSURES

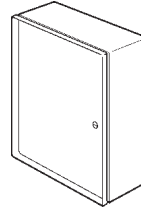

#### APPLICATIONS

Concept enclosures house and protect your sensitive electrical or electronic components from harsh and dirty environments. For use in installations where dirt, dust, oil, water, or other contaminants are present. Streamline styling, flush latching, and an attractive durable finish complement other electronic equipment.

#### CONSTRUCTION

- Seams continuously welded and ground smooth
- Minimum width body flange provides maximum door opening (210 degrees)
- Hidden hinges for clean aesthetic appearance
- Doors are interchangeable and easily removed by pulling captive hinge pins
- Seamless foam-in-place gasket provides oil tight and dust-tight seal
- Streamlined styling to complement other electronic equipment

#### INDUSTRY STANDARDS

UL 508A, File No. E61997: Type 4, & 12  
 NEMA/EEMAC Type 4 & 12  
 CSA File #LR42186, Type 4 & 12  
 IEC 60529, IP66

### ENCLOSURES

Vendor Code: **HOF**

Catalog Number	Dimensions			Use With Back Panel (see table below)	Price Each
	H	W	D		
CSD20166	20"	16"	6"	CP2016	376.83
CSD24208	24"	20"	8"	CP2420	395.00
CSD30248	30"	24"	8"	CP3024	552.99
CSD36248	36"	24"	8"	CP3624	520.00
CSD363610	36"	36"	10"	CP3636	778.17

### BACK PANELS

Vendor Code: **HOF**

Catalog Number	Dimensions		Price Each
	Height	Width	
CP2016	18.20"	14.20"	48.99
CP2420	22.20"	18.20"	75.00
CP3024	28.20"	22.20"	106.00
CP3624	34.20"	22.20"	124.00
CP3636	34.20"	34.20"	191.00



F Enclosures & Wireway



Hoffman® (Screw Cover Pull Boxes · Wireways · Couplings and Ends)

SCREW COVER PULL BOXES

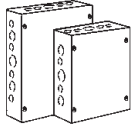

Vendor Code: HOF

Catalog Number	Dimensions			Price Each
	H	W	D	
<b>PAINTED WITH KNOCKOUTS</b>				
ASE4X4X4	4"	4"	4"	8.32
ASE6X6X4	6"	6"	4"	10.28
ASE6X6X6	6"	6"	6"	12.41
ASE8X8X4	8"	8"	4"	14.14
ASE8X8X6	8"	8"	6"	16.95
ASE10X10X4	10"	10"	4"	18.56
ASE10X10X6	10"	10"	6"	22.00
ASE12X12X4	12"	12"	4"	23.78
ASE12X12X6	12"	12"	6"	27.92
ASE16X16X6	16"	16"	6"	41.69
ASE18X18X4	18"	18"	4"	42.61
ASE18X18X6	18"	18"	6"	49.76
ASE24X24X6	24"	24"	6"	100.95
<b>GALVANIZED WITHOUT KNOCKOUTS</b>				
ASG6X6X4NK	6"	6"	4"	9.77
ASG6X6X6NK	6"	6"	6"	11.83
ASG8X8X4NK	8"	8"	4"	13.40
ASG8X8X6NK	8"	8"	6"	16.09
ASG10X10X4NK	10"	10"	4"	17.62
ASG10X10X6NK	10"	10"	6"	20.95
ASG12X12X4NK	12"	12"	4"	22.63
ASG12X12X6NK	12"	12"	6"	29.28
ASG18X18X6NK	18"	18"	6"	47.31
ASG24X24X8NK	24"	24"	8"	117.62

RAINTIGHT SCREW COVER PULL BOXES

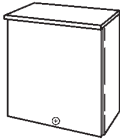

Vendor Code: HOF

Catalog Number	Dimensions			Price Each
	H	W	D	
A4R44	4"	4"	4"	19.37
A6R64	6"	6"	4"	19.14
A6R66	6"	6"	6"	20.24
A8R84	8"	8"	4"	25.28
A8R86	8"	8"	6"	29.68
A10R104	10"	10"	4"	32.43
A10R106	10"	10"	6"	38.00
A12R124	12"	12"	4"	40.74
A12R126	12"	12"	6"	47.49
A18R186	18"	18"	6"	96.07
A18R188	18"	18"	8"	107.07
A24R248	24"	24"	8"	184.84

See Page F6 for NEMA Type 4, 12 and 13 Enclosures.

HINGED LAY-IN INDOOR WIREWAYS

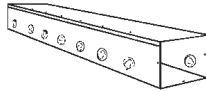

4" X 4"

Vendor Code: HOF

Catalog Number	Length	Price Each
<b>PAINTED WITH KNOCKOUTS</b>		
F44G12WK	12"	11.96
F44G24WK	24"	18.93
F44G36WK	36"	28.70
F44G48WK	48"	38.37
F44G60WK	60"	40.92
<b>GALVANIZED WITHOUT KNOCKOUTS</b>		
F44T124GV	24"	17.04
F44T136GV	36"	25.77

6" X 6"

Vendor Code: HOF

Catalog Number	Length	Price Each
<b>PAINTED WITH KNOCKOUTS</b>		
F66G12WK	12"	23.68
F66G24WK	24"	30.47
F66G36WK	36"	41.00
F66G48WK	48"	56.13
F66G60WK	60"	61.31
<b>GALVANIZED WITHOUT KNOCKOUTS</b>		
F66T124GV	24"	27.44
F66T136GV	36"	36.90
F66T148GV	48"	50.43

8" X 8"

Vendor Code: HOF

Catalog Number	Length	Price Each
<b>PAINTED WITHOUT KNOCKOUTS</b>		
F88G24	24"	58.55
F88G36	36"	89.81
F88G48	48"	108.64
F88G60	60"	122.56
<b>GALVANIZED WITHOUT KNOCKOUTS</b>		
F88T136GV	36"	81.32
F88T148GV	48"	98.28

COUPLINGS AND ENDS



Couplings



Ends

Vendor Code: HOF

Catalog Number	Size	Price Each
<b>COUPLINGS</b>		
F44GUC	4" x 4"	4.28
F66GUC	6" x 6"	6.37
F88GUC	8" x 8"	8.56
<b>END PLATES, PAINTED</b>		
F44GCP	4" x 4"	4.28
F66GCP	6" x 6"	6.31
F88GCP	8" x 8"	8.44
<b>END PLATES, GALVANIZED WITHOUT KNOCKOUTS</b>		
F44GCPNGV	4" x 4"	4.16
F66GCPNGV	6" x 6"	6.07
F88GCPNGV	8" x 8"	8.13

SCREW COVER RAIN-TIGHT WIREWAYS

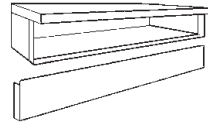

4" X 4"

Vendor Code: HOF

Catalog Number	Length	Price Each
<b>PAINTED</b>		
A4412RT	12"	37.76
A4424RT	24"	53.66
A4436RT	36"	70.37
A4448RT	48"	86.17
<b>GALVANIZED</b>		
F4412RTGV	12"	30.21
F4424RTGV	24"	39.87

6" X 6"

Vendor Code: HOF

Catalog Number	Length	Price Each
<b>PAINTED</b>		
A6612RT	12"	49.03
A6624RT	24"	73.44
A6636RT	36"	97.72
A6648RT	48"	139.33
A6660RT	60"	145.05
A6672RT	72"	194.64
<b>GALVANIZED</b>		
F6612RTGV	12"	39.23
F6624RTGV	24"	58.20
F6636RTGV	36"	78.27
F6648RTGV	48"	100.12
F6672RTGV	72"	145.65

8" X 8"

Vendor Code: HOF

Catalog Number	Length	Price Each
<b>PAINTED</b>		
A8824RT	24"	98.28
A8836RT	36"	131.11
A8848RT	48"	163.87
A8860RT	60"	197.24
<b>GALVANIZED</b>		
F8824RTGV	24"	78.88
F8836RTGV	36"	104.98
F8848RTGV	48"	125.61
F8872RTGV	72"	215.44



HOFFMAN



Heating, Ventilating & Air Conditioning

G

SECTION



**Heating, Ventilating  
& Air Conditioning**



Heating, Ventilating & Air Conditioning

Condensers, Furnaces

Condensers.....	G3
Furnaces.....	G4
Air Handlers .....	G4

Accessories

Thermostats .....	G5
Refrigerant .....	G5
Filters .....	G5
Registers .....	G6
Capacitors .....	G7
Motors, Hard Start Kits, Drain Guns .....	G8
Regulators, Gauges, Contactors.....	G9
Cleaners, Plenums, Drain Pans.....	G10
Ventilation .....	G11

Mini-Split System

Mini-Split System.....	G12
------------------------	-----

Heating, Ventilating & Air Conditioning

G





### R410 CONDENSERS AND HEAT Pumps

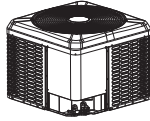
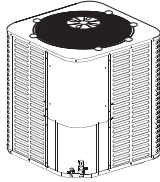

Fraser-Johnston condensers and heat pumps can help meet your heating and cooling needs while staying within your budget. Their condenser units are equipped with essential features to cool your home quietly and effectively in warm weather, while their heat pumps can remove heat when it's warm and add heat when it's cool. Your heating and cooling installer can help you decide which Fraser-Johnston component is right for your home.

- A compact design and small footprint require minimal yard space
- Fraser-Johnston air conditioners and heat pumps operate quietly, with a maximum sound level of 76 decibels.
- Painted, galvanized steel cabinets resist rust and stand up to weather, helping to maintain the life of your unit.
- 10 year registered limited warranty\* / 5 year base limited warranty (R-410A Models)

### AIR CONDITIONERS

Vendor Code: **YIN**

Catalog Number	Tonnage	Dimensions (in.)			Price Each
		H	W	D	
<b>1-PH, 208/230V - 14 SEER</b>					
<b>TC4B1822S</b>	1.5	30	24	24	1239.47
<b>TC4B2422S</b>	2	26.75	29.25	29.25	1317.67
<b>TC4B3022S</b>	2.5	26.75	29.25	29.25	1421.93
<b>TC4B3622S</b>	3	30	29.25	29.25	1561.40
<b>TC4B4222S</b>	3.5	36.25	29.25	29.25	1758.20
<b>TC4B4821S</b>	4	33.25	35.25	31.75	1988.88
<b>TC4B6021S</b>	5	36.25	38	34.25	2271.72
<b>1-PH, 208/230V - 15 SEER</b>					
<b>TC7B1821S</b>	1.5	30	29.25	29.25	1642.98
<b>TC7B2421S</b>	2	30	29.25	29.25	1704.13
<b>TC7B3021S</b>	2.5	36.25	35.25	31.75	1974.50
<b>TC7B3621S</b>	3	36.25	35.25	31.75	2116.97
<b>TC7B4221S</b>	3.5	39.5	38	34.25	2516.60
<b>TC7B4821S</b>	4	39.5	38	34.25	2732.05
<b>TC7B6021S</b>	5	42.75	38	34.25	2895.88

### HEAT PUMPS

Vendor Code: **YIN**

Catalog Number	Tonnage	Dimensions (in.)			Price Each
		H	W	D	
<b>1-PH, 208/230V - 14 SEER</b>					
<b>TH4B1821S</b>	1.5	33.25	29.25	29.25	1574.47
<b>TH4B2421S</b>	2	36.25	29.25	29.25	1708.68
<b>TH4B3021S</b>	2.5	39.5	35.25	31.75	1791.33
<b>TH4B3622S</b>	3	39.5	38	34.25	2157.13
<b>TH4B4222S</b>	3.5	39.5	38	34.25	2299.52
<b>TH4B4822S</b>	4	39.5	38	34.25	2495.92
<b>TH4B6022S</b>	5	42.5	38	34.25	2748.78
<b>1-PH, 208/230V - 16 SEER</b>					
<b>TH16B2421S</b>	2	33.25	29.25	29.25	2355.03
<b>TH16B3621S</b>	3	39.5	29.25	29.25	2668.77
<b>TH16B4821S</b>	4	39.5	35.25	31.75	3179.77
<b>TH16B6021S</b>	5	39.5	35.25	31.75	3533.23

### R407C STRAIGHT COOLING CONDENSER GUARDIAN

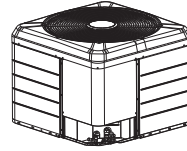

The GAW14L models meet the Minimum Efficiencies in all US DOE Regions and are specifically designed to be matched with Johnson Controls Unitary Products R-407C indoor coils to provide a complete system solution.

- R22 System Compatible
- Independent panels provide quick access for unit setup. Installation time is reduced by easy power and control wiring access. The factory installed filterdrier means less time spent brazing and charging the system. The small base dimension and reduced unit clearances make for easier retrofits.
- Shipped with 1 LB. of R407C holding charge the remaining refrigerant must be field sourced and charged by a certified HVAC technician.
- The coated steel wire fan guard, coated external fasteners, and pre-treated G90-equivalent galvanized steel chassis components resist corrosion and rust creep. Powdercoat paint further protects external panels.

Vendor Code: **YIN**

Catalog Number	Tonnage	Dimensions (in.)			Price Each
		H	W	D	
<b>1-PH, 208/230V - 14 SEER</b>					
<b>GAW14L18C23S</b>	1.5	30	29.25	29.25	1218.23
<b>GAW14L24C23S</b>	2	30	29.25	29.25	1294.57
<b>GAW14L30C23S</b>	2.5	36.25	29.25	29.25	1383.83
<b>GAW14L36C23S</b>	3	33.25	35.25	31.75	1496.88
<b>GAW14L48C23S</b>	4	36.25	38	34.25	1866.23
<b>GAW14L60C23S</b>	5	42.25	38	34.25	2092.32

#### Please Note

HVAC products are available only at select Elliott Electric Supply locations. Please contact your local rep for details.

Refrigerant and products which contain refrigerant will only be sold to individuals in possession of a valid EPA certification, or if a valid certification is on file for customer's account.

\* Registered Limited Warranty terms are applicable if the products are registered within 60 days of installation. Products can be registered online at [www.upgproductregistration.com](http://www.upgproductregistration.com) otherwise Fraser-Johnston Base Limited Warranty terms will apply.

**SEER:** Seasonal Energy Efficiency Ratio. The higher the SEER ratio, the greater the efficiency.

**AFUE:** Annual Fuel Utilization Efficiency. The percentage of fuel burned converted to heat.

**FRASER-JOHNSTON**  
Heating • Air Conditioning  
a division of Johnson Controls  
MADE IN AMERICA



**FURNACES**  
80% AFUE

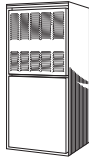

Designed with value in mind, Fraser-Johnston furnaces can heat your home with either natural gas or propane. In summer, your furnace also works with your outdoor system to circulate cool air, helping keep you comfortable all year long.

- Flexible heating with natural gas or propane
- Durable, aluminized steel heat exchanges conduct heat with greater efficiency than other options.
- Galvanized steel cabinets resist corrosion
- Adaptable designs ensure the right fit for your home
- 10 year registered limited warranty\* / 5 year base limited warranty
- 20 year registered heat exchanger warranty\* / 20 year base heat exchanger warranty.

Vendor Code: **YIN**

Catalog Number	Nominal CFM	BTU	Dimensions (in.)			Price Each
			H	W	D	
<b>115V</b>						
TM8E040A12MP11	1,200	40,000	33	14.5	29.5	1012.92
TM8E060A12MP11	1,200	60,000	33	14.5	29.5	1043.97
TM8E080B12MP11	1,200	80,000	33	17.5	29.5	1098.48
TM8E080C16MP11	1,600	80,000	33	21	29.5	1138.50
TM8E100B12MP11	1,200	100,000	33	17.5	29.5	1173.00
TM8E100C16MP11	1,600	100,000	33	21	29.5	1177.13
TM8E100C20MP11	2,000	100,000	33	21	29.5	1219.23
TM8E120C20MP11	2,000	120,000	33	21	29.5	1302.72

**AIR HANDLERS**

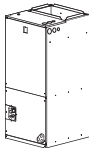

Vendor Code: **YIN**

Catalog Number	Tonnage	Dimensions (in.)			Price Each
		H	W	D	
<b>PSC MOTOR</b>					
AP24BX21	2	41	17.5	21.4375	774.00
AP30BX21	2.5	47.5	17.5	21.4375	840.50
AP37CX21	3	51.5	21	21.4375	1009.07
AP48CX21	4	51.5	21	21.4375	1103.10
<b>ECM MOTOR</b>					
AE24BX21	2	41	17.5	21.4375	941.20
AE36BX21	3	47.5	17.5	21.4375	1086.67
AE48CX21	4	51.5	21	21.4375	1303.02
AE60CX22	5	55.5	21	21.4375	1485.78
AE60DX21	5	55.5	24.5	21.4375	1510.65

**FRASER-JOHNSTON**  
Heating • Air Conditioning  
a division of Johnson Controls  
MADE IN AMERICA

**HEATER ELEMENTS**

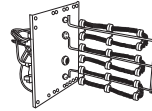

Vendor Code: **YIN**

Catalog Number	KW	Heater Amps	Price Each
<b>W/SERVICE DISCONNECT</b>			
S16HK16500506	5	20	116.67
S16HK16500806	8	32	122.85
S16HK16501006	10	40	138.45
<b>W/SERVICE DISCONNECT &amp; BREAKER JUMPER BAR</b>			
S16HK26501306	13	52	266.77
S16HK26501506	15	60	265.67
S16HK26501806	18	72	289.45
S16HK26502006	20	80	299.47

**EXPANSION VALVES**

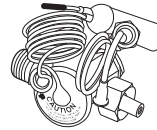

Vendor Code: **YIN**

Catalog Number	Tonnage	Price Each
<b>TXV 3/4" CHATLEFF</b>		
S11TVMBA1	1.5 - 3.5	67.87
S11TVMBB1	2.5 - 4	67.87
S11TVMBC1	4 - 5	68.20
S11TVMBD1	5	68.53
S11TVMBG1	5	67.60
S11TVMBH1	1.5 - 3.5	66.97
<b>TXV WASHER</b>		
S102131419000		0.40

**EVAPORATOR COILS**

Vendor Code: **YIN**

Catalog Number	Tonnage	Dimensions (in.)			Price Each
		H	W	D	
CM24AXA1	2	19.5	14.5	21.5	450.45
CM30BXA1	2.5	25.5	17.5	21.5	515.97
CM36BXA1	3	25.625	17.5	21.5	562.77
CM36CXA1	3	25	21	21.5	569.78
CM42CXA1	3.5	27	21	21.5	623.62
CM48CXA1	4	33	21	21.5	696.15
CM60CXA2	5	33	21	21.5	848.25
CM64DXA1	5	32.75	24.25	21.5	1109.17

**SEER:** Seasonal Energy Efficiency Ratio. The higher the SEER ratio, the greater the efficiency.

**AFUE:** Annual Fuel Utilization Efficiency. The percentage of fuel burned converted to heat.

**Please Note**

HVAC products are available only at select Elliott Electric Supply locations. Please contact your local rep for details.



### THERMOSTATS ROBERTSHAW

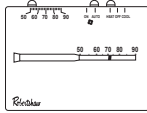

9200H

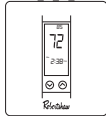

RS332N

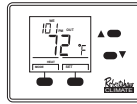

RS1110

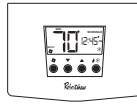

RS6220

Vendor Code: **RSW**

Catalog Number	Stages	Display Size	Switching/ Voltage	Control Type	Temp. Range	Price Each
<b>NON-PROGRAMMABLE</b>						
9200H	1H/1C	Dial	SPDT 24V	Mechanical	50F-90F	20.47
80122*	1H	Dial	SPST 120/240/277	Mechanical	50F-90F	15.42
80222*	1H	Dial	DPST 120/240/277	Mechanical	50F-90F	16.15
RS4110	1H/1C	2.25" x 1"	24V	Electronic	45F-90F	52.42
RS4220	2H/2C	2.25" x 1"	24V	Electronic	45F-90F	57.42
RS311N	1H/1C	1" x 2"	SPDT 24V	Electronic	38F-108F	85.03
RS321N	2H/1C	1" x 2"	24V	Electronic	38F-108F	106.31
RS332N	3H/2C	1" x 2"	24V	Electronic	38F-108F	114.65
<b>PROGRAMMABLE</b>						
RS1110	1H/1C	2" x 1.75"	SPDT 24V	Electronic	40F-90F	27.09
RS6110	1H/1C	2.25" x 1"	SPDT 24V	Electronic	45F-90F	63.78
RS6220	2H/2C	2.25" x 1"	24V	Electronic	45F-90F	71.25
RS6320	3H/2C	2.25" x 1"	24V	Electronic	45F-90F	98.18
RS7210	2H/1C	4.5"	24V	Electronic with WiFi	46F-99F	106.66

\*These Items are Suitable for Use with Electric Systems Only. All Others are Suitable for Use with Gas/Oil/Electric/Heat Pump Systems.

### THERMOSTATS PRO1 - IAQ



T701



T801



T755S



T855I

Vendor Code: **IAQ**

Catalog Number	Stages	Display Size	Switching/ Voltage	Control Type	Temp Range	Price Each
<b>NON-PROGRAMMABLE</b>						
T701	1H/1C	4"	24V	Electronic	44F-90F	38.29
T771	1H or 1C	4"	24V	Electronic	25F-99F	36.77
T721	1H/1C CONV / 2H/1C HP	4"	24V	Electronic	44F-90F	50.73
T801	1H/1C	8"	24V	Electronic	44F-90F	74.73
<b>PROGRAMMABLE</b>						
T705	1H/1C	4"	24V	Electronic	44F-90F	42.56
T725	1H/1C CONV / 2H/1C HP	4"	24V	Electronic	44F-90F	54.98
T755	2H/2C CONV / 3H/2C HP	6"	24V	Electronic	44F-90F	73.30
T805	1H/1C	8"	24V	Electronic	44F-90F	78.27
T7011	1H/1C	4"	24V	Electronic with WiFi	44F-90F	93.30
T755S	2H/2C CONV / 3H/2C HP	6"	24V	Electronic	44F-90F	98.34
T855S	2H/2C CONV / 3H/2C HP	8"	24V	Electronic	44F-90F	103.93
T855SH	2H/2C CONV / 5H/3C HP	8"	24V	Electronic	44F-90F	103.95
T905	1H/1C	13"	24V	Electronic	44F-90F	119.66
T955	2H/2C CONV / 3H/2C HP	13"	24V	Electronic	44F-90F	145.35
T855I	2H/2C CONV / 4H/2C HP	8"	24V	Electronic with WiFi	44F-90F	144.08
T955S	2H/2C CONV / 3H/2C HP	13"	24V	Electronic	44F-90F	163.68

These Items are Suitable for Use with Gas/Oil/Electric/Heat Pump Systems.

### REFRIGERANT



Vendor Code: **RFR**

Catalog Number	Cylinder Size (lb)	Price Each
R134A30	30	130.00
R2230	30	513.33
R404A24	24	125.00
R407C25	25	125.00
R410A25	25	113.33
R421A25	25	281.67
R422B25	25	198.33
R438A25	25	294.00

#### Please Note

Refrigerant is a commodity and is subject to weekly price changes.

Refrigerant and products which contain refrigerant will only be sold to individuals in possession of a valid EPA certification, or if a valid certification is on file for customer's account.

### WIRE BACK PLEATED FILTER MX 40 MERV 8

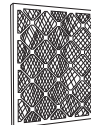

Vendor Code: **CLR**

Catalog Number	Size	Price Each
450122	12" X 12" X 1"	3.95
450100	12" X 24" X 1"	3.77
450139	14" X 20" X 1"	3.72
450141	14" X 25" X 1"	3.94
450245	15" X 20" X 2"	4.55
450243	16" X 16" X 2"	3.90
450101	16" X 20" X 1"	3.50
450201	16" X 20" X 2"	3.77
450401	16" X 20" X 4"	7.99
450102	16" X 25" X 1"	3.95
450202	16" X 25" X 2"	4.38
450402	16" X 25" X 4"	8.45
450180	18" X 20" X 1"	5.20
450112	18" X 24" X 1"	4.70
450103	20" X 20" X 1"	3.95
450203	20" X 20" X 2"	4.38
450403	20" X 20" X 4"	8.49
450111	20" X 24" X 1"	4.48
450104	20" X 25" X 1"	4.57
450204	20" X 25" X 2"	5.30
450404	20" X 25" X 4"	9.52
450132	20" X 30" X 1"	7.00
450105	24" X 24" X 1"	4.84
450205	24" X 24" X 2"	5.95
450125	25" X 25" X 1"	5.50

Heating, Ventilating & Air Conditioning

G



**R8 FLEX DUCT  
25' BAG**



Vendor Code: **FXD**

Catalog Number	Size	Price Each
FD4R8	4"	38.88
FD5R8	5"	42.00
FD6R8	6"	44.08
FD7R8	7"	49.50
FD8R8	8"	54.17
FD9R8	9"	59.63
FD10R8	10"	65.00
FD12R8	12"	79.92
FD14R8	14"	94.83
FD16R8	16"	113.08
FD18R8	18"	134.00
FD20R8	20"	176.67

**SUPPLY AIR REGISTERS  
3 WAY CEILING**

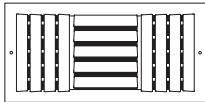

Vendor Code: **GDR**

Catalog Number	Size	Price Each
3SW0804	8" x 4"	3.18
3SW1006	10" x 6"	4.10
3SW1008	10" x 8"	4.67
3SW1206	12" x 6"	4.43
3SW1208	12" x 8"	5.82
3SW1406	14" x 6"	5.45
3SW1408	14" x 8"	6.45

**SUPPLY AIR REGISTERS  
CURVED**

Vendor Code: **GDR**

Catalog Number	Size	Price Each
<b>1 WAY</b>		
1CB0804	8" x 4"	3.35
1CB1006	10" x 6"	4.30
1CB1008	10" x 8"	4.92
1CB1206	12" x 6"	4.65
1CB1208	12" x 8"	6.10
1CB1406	14" x 6"	5.72
1CB1408	14" x 8"	6.90
<b>3 WAY</b>		
3CB0804	8" x 4"	3.35
3CB1006	10" x 6"	4.30
3CB1008	10" x 8"	4.92
3CB1206	12" x 6"	4.65
3CB1208	12" x 8"	6.10
3CB1406	14" x 6"	5.72
3CB1408	14" x 8"	6.90

**STAMPED RETURN AIR  
FLAT GRILLE**

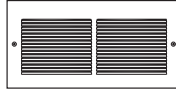

Vendor Code: **GDR**

Catalog Number	Size	Price Each
1RA0606	6" x 6"	1.53
1RA0804	8" x 4"	1.52
1RA0808	8" x 8"	2.22
1RA1006	10" x 6"	2.05
1RA1008	10" x 8"	2.90
1RA1010	10" x 10"	3.57
1RA1206	12" x 6"	2.45
1RA1212	12" x 12"	3.65
1RA1406	14" x 6"	1.93
1RA1408	14" x 8"	2.80
1RA1414	14" x 14"	5.20
1RA1608	16" x 8"	3.60
1RA1610	16" x 10"	4.33
1RA1810	18" x 10"	4.97
1RA2010	20" x 10"	5.43
1RA2020	20" x 20"	10.20
1RA2025	20" x 25"	11.90
1RA2410	24" x 10"	4.38
1RA2412	24" x 12"	7.27
1RA2516	25" x 16"	7.33
1RA2520	25" x 20"	11.90
1RA3010	30" x 10"	7.10
1RA3012	30" x 12"	8.20
1RA3014	30" x 14"	9.75
1RA3020	30" x 20"	10.47

**STAMPED RETURN AIR  
FILTER GRILLE**

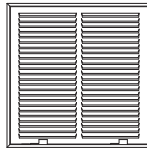

Vendor Code: **GDR**

Catalog Number	Size	Price Each
1RAF1212	12" x 12"	9.55
1RAF1425	14" x 25"	18.15
1RAF1625	16" x 25"	19.73
1RAF2020	20" x 20"	17.20
1RAF2025	20" x 25"	21.48
1RAF2030	20" x 30"	29.27
1RAF2514	25" x 14"	18.15
1RAF2516	25" x 16"	19.73
1RAF2520	25" x 20"	21.48
1RAF3020	30" x 20"	27.43

**SUPPLY AIR REGISTERS  
ADJUSTABLE BLADE**

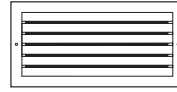

Vendor Code: **GDR**

Catalog Number	Size	Price Each
SDFSABS0804	8" x 4"	6.55
SDFSABS1006	10" x 6"	8.05
SDFSABS1008	10" x 8"	9.60
SDFSABS1206	12" x 6"	9.42
SDFSABS1208	12" x 8"	11.07
SDFSABS1406	14" x 6"	10.75
SDFSABS1408	14" x 8"	16.30

**SUPPLY AIR REGISTERS  
2 WAY SIDEWALL**

Vendor Code: **GDR**

Catalog Number	Size	Price Each
2SW0804	8" x 4"	3.18
2SW1006	10" x 6"	4.10
2SW1206	12" x 6"	4.43
2SW1406	14" x 6"	5.45

**CONCRETE PADS**

Vendor Code: **DVV**

Catalog Number	Size	Price Each
L30303	30" x 30" x 3"	47.10
L36363	36" x 36" x 3"	64.58
L36423	36" x 42" x 3"	72.38

**PLASTIC PADS**

Vendor Code: **DVV**

Catalog Number	Size	Price Each
EL30303	30" x 30" x 3"	40.73
EL36363	36" x 36" x 3"	58.13
EL36483	36" x 48" x 3"	74.52

**Please Note**  
HVAC products are available only at select Elliott Electric Supply locations. Please contact your local rep for details.





## Motor Run Capacitors

### MOTOR RUN CAPACITOR 370/440V

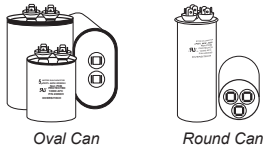

Oval Can

Round Can

Vendor Code: **GBL**

Catalog Number	MicroFarads	Price Each
<b>SINGLE CAPACITANCE - OVAL</b>		
2028	4	4.93
2029	5	4.63
2031	7.5	5.35
2032	10	5.93
2033	12.5	7.13
2034	15	7.63
2036	17.5	6.25
2035	20	5.43
2040	25	6.25
2043	35	10.03
2045	40	7.88
2048	45	8.63
2052	55	9.20
2054	60	18.75
<b>SINGLE CAPACITANCE - ROUND</b>		
2252	4	5.55
2253	5	5.83
2255	7.5	6.50
2256	10	7.30
2257	12.5	7.90
2258	15	8.50
2259	17.5	9.23
2260	20	9.80
2261	25	11.18
2262	30	12.45
2263	35	14.30
2264	40	15.93
2265	45	17.38
2266	50	19.23
2267	55	21.73
2299B	60	24.40
2295	65	26.58
2296	80	29.80
<b>DUAL CAPACITANCE</b>		
2271	25/5	14.75
2272	30/5	14.35
2273	35/5	15.58
2290	40/5	20.00
2297	45/5	21.03
2298A	40/7.5	22.48
2299	45/7.5	23.58
2299A	50/5	23.88
2267B	55/5	22.80
2298B	60/6	26.50
2298	60/7.5	27.08
2299AA	80/5	32.10

Metal Cans

Replacement capacitors must be as high or higher than the original and same MicroFarads.

### MOTOR RUN CAPACITOR 370/440V MADE IN THE U.S.A.



Round Can

Vendor Code: **GBL**

Catalog Number	MicroFarads	Price Each
<b>SINGLE CAPACITANCE - ROUND</b>		
USA2204	5	11.73
USA2206	7.5	11.68
USA2207	10	13.35
USA2208	12.5	14.05
USA2209	15	13.35
USA2211	20	17.98
USA2212	25	21.93
USA2213	30	24.10
USA2214	35	27.83
USA2215	40	28.88
USA2216	45	31.78
USA2217	50	35.85
USA2218	55	36.85
USA2219	60	37.13
USA2220	65	40.13
USA2228	70	46.33
USA2229	80	60.53
<b>DUAL CAPACITANCE - ROUND</b>		
USA2225	25/5	24.40
USA2226	30/5	26.25
USA2227	35/5	29.55
USA2291	35/7.5	30.65
USA2235	40/5	34.20
USA2232	40/7.5	34.23
USA2236	45/5	34.43
USA2233	45/7.5	34.43
USA2237	50/5	39.03
USA2240	55/5	42.15
USA2220B	60/5	41.75
USA2222BA	80/5	55.38

Metal Cans

### TURBO MULTI RUN CAPACITOR 370/440V

Vendor Code: **GBL**

Catalog Number	MicroFarads	Price Each
<b>OVAL</b>		
TURBOMINIOWAL	2.5-15	18.68
<b>ROUND</b>		
TURB0200	2.5-67.5	102.38

### TURBO START CAPACITOR 330V

Vendor Code: **GBL**

Catalog Number	MicroFarads	Price Each
TURB0LYTICR	0-277	90.55
TURB0LYTIC50	0-302	132.43



### MOTOR RUN CAPACITOR 370/440V



Round Can

Vendor Code: **MAI**

Catalog Number	MicroFarads	Price Each
<b>DUAL CAPACITANCE - ROUND</b>		
12816	80/7.5	22.90
12821	80/10	28.35

Metal Cans

### MOTOR START CAPACITOR



Vendor Code: **MAI**

Catalog Number	MicroFarads	Price Each
<b>110/125V</b>		
11910	108-130	3.50
11913	145-174	3.63
11914	161-193	3.73
11915	189-227	3.83
11916	200-240	4.40
11917	216-259	4.15
11918	233-291	4.23
11919	270-324	4.48
11921	324-388	4.58
11924	400-480	5.73
11925	460-552	5.70
11926	540-648	6.08
11927	590-708	7.08
11929	829-995	8.35
<b>220/250V</b>		
11944	72-88	4.95
11946	108-130	6.15
11948	124-155	6.90
11949	145-175	7.00
11950	161-193	7.65
11951	189-227	8.88
11952	216-259	9.68
11953	233-292	10.08
11954	270-324	11.35
<b>330V</b>		
11962	88-108	6.38
11965	124-156	6.78
11966	145-174	8.58
11968	189-227	9.83
11970	270-324	11.85



Heating, Ventilating & Air Conditioning

G

**CONDENSER FAN MOTORS**  
BALL BEARING SHAFT  
1/2" X 6"



Vendor Code: **PEM**

Catalog Number	HP	RPM	FLA	Price Each
<b>SINGLE SPEED, 208 - 230V</b>				
EM3404	1/4	825	1.5	110.28
EM3405	1/3	825	1.8	127.86
EM3727	1/6	1,075	1.3	81.14
EM3728	1/4	1,075	1.8	91.50
EM3729	1/3	1,075	2.5	96.54
EM3730	1/2	1,075	3.5	113.04
EM3731	3/4	1,075	5.3	137.62
<b>MULTIPLE HP, TWO SPEED, 208/230V</b>				
EM3469	1/3-1/5	825	1.9/1.2	121.34
EM3465	1/3-1/5	1,075	2.6/1.4	111.78
EM3468	1/2-1/4	1,075	3.6/1.7	129.18

**DIRECT DRIVE**  
**FURNACE BLOWER MOTORS**  
SLEEVE BEARING SHAFT  
1/2" X 6"



Vendor Code: **PEM**

Catalog Number	HP	RPM	FLA	Price Each
<b>THREE SPEED, 115V</b>				
EM3583	1/4	1075	4.6	93.00
EM3585	1/3	1075	6.7	104.56
EM3587	1/2	1075	10.2	127.52
EM3589	3/4	1075	11.3	131.28
<b>THREE SPEED, 230V</b>				
EM3584	1/4	1075	2.2	93.94
EM3586	1/3	1075	2.9	105.58
EM3588	1/2	1075	5	128.82
EM3590	3/4	1075	5.4	132.60
<b>MULTIPLE HP, FOUR SPEED, 115V</b>				
EM3463	1/2-1/6	1075	7	118.12
EM3466	3/4-1/5	1075	8.1	141.70
<b>MULTIPLE HP, FOUR SPEED, 230V</b>				
EM3464	1/2-1/6	1075	3.9	120.64
EM3467	3/4-1/5	1075	3.8	146.06

**HARD START KITS**



Vendor Code: **CPO**

Catalog Number	Description	Price Each
CSRU1	for 1 - 3 Ton Compressor	36.58
CSRU2	for 3 1/2 - 5 Ton Compressor	44.92
CSRU3	for 4 - 5 Ton Compressor	49.92

**COMPRESSOR**  
**TERMINAL REPAIR KITS**



Vendor Code: **MSR**

Catalog Number	Wire	Price Each
<b>3 LUGS / MALE SPADES</b>		
QT2800	No Wire	30.28
<b>3 LUGS / 2' LEADS</b>		
QT2812	12 AWG	31.70
QT2810	10 AWG	32.42
<b>3 LUGS / 4' LEADS</b>		
QT2912	12 AWG	34.13
QT2910	10 AWG	35.60

**ADDITIVE INJECTION TOOL**

Vendor Code: **MSR**

Catalog Number	Bottle Size	Price Each
QT2510	1/2 oz.	33.05
QT2520	2 oz.	57.72
QT2511	4 oz.	82.88

**ACID NEUTRALIZER**  
**ALL OILS**

Vendor Code: **MSR**

Catalog Number	Bottle Size	Price Each
QT2511	1/2 oz.	82.88

**REPLACEMENT O-RINGS**

Vendor Code: **MSR**

Catalog Number	Description	Price Each
QT2512	for 1/2 oz. Injector	7.60
QT2513	for 2 & 4 oz. Injector	8.03

**2 SECOND ACID TEST KIT**



Vendor Code: **MSR**

Catalog Number	Bottle Size	Price Each
QT2511	1/2 oz.	82.88

**DRAIN GUN**

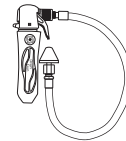

Vendor Code: **MOR**

Catalog Number	Description	Price Each
TGG1	Charles Gallo Brand Drain Gun	57.83
TGG1A	Drain Gun Adapter Kit	17.99
TGGC12	Package of 12 CO <sup>2</sup> Cartridges	39.43
TGGC6	Package of 6 CO <sup>2</sup> Cartridges	26.55

**CONDENSATE PUMPS**

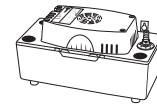

Vendor Code: **MOR**

Catalog Number	Description	Price Each
CP22T	120V, 22' Lift, with 20' of 3/8" CVT	81.27
CP2230T	230V, 22' Lift, with 20' of 3/8" CVT	93.22
CP22LP	120V, 22' Lift, Low Profile Unit	89.64

**Please Note**

HVAC products are available only at select Elliott Electric Supply locations. Please contact your local rep for details.

Refrigerant and products which contain refrigerant will only be sold to individuals in possession of a valid HVAC license, or if a valid license is on file for customer's account.



## SOLDERING



SB61



1400351

Vendor Code: **HRR**

Catalog Number	Description	Price Each
<b>SCPF4</b>	Soft Solder Flux 4 oz. Bottle	3.83
<b>SB61</b>	Stay Brite 1/8" x 1# Spool	45.32
<b>1601112</b>	Heat-Tip HA-81 Soft Solder	77.32
<b>1400351</b>	Hand Held Trigger Torch	94.15
<b>4400083</b>	B Tank Soldering Kit W/O	282.22

## REGULATORS



Vendor Code: **HRR**

Catalog Number	Description	Price Each
<b>3000407</b>	Acet. Regulator 0-30 psig	83.73
<b>3000412</b>	Oxygen Regulator 0-80 psig	83.73
<b>3000606</b>	Nitrogen Regulator 25GX-5	137.07

## REPLACEMENT GAUGES



Vendor Code: **HRR**

Catalog Number	Description	Price Each
<b>4300749</b>	Acet. Replacement Gauge Outlet	15.05
<b>4300750</b>	Acet. Replacement Gauge Inlet	15.05
<b>4300751</b>	Oxy. Replacement Gauge 0-400 psi	15.05
<b>4300752</b>	Oxy. Replacement Gauge 0-4000 psi	15.05

## HOSES



Vendor Code: **HRR**

Catalog Number	Description	Price Each
<b>HOSES</b>		
<b>4300775</b>	3/16" x 12' Red Acetylene Only	29.07
<b>4300155</b>	3/16" x 12' Oxygen/Acetylene Green/Red Hose	31.85

## HVAC PORT-A-TORCH®

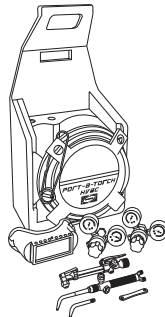

The Harris HVAC Port-A-Torch contains all the quality equipment needed for brazing. Packaged in a rugged, molded plastic carrying case, the solid brass brazing handle and cutting attachment have industry standard connections which make them compatible with most brazing equipment. The outfit is designed to carry one MC acetylene cylinder and one 20 cu. ft. oxygen cylinder. As supplied, the outfit is capable of cutting up to a 1" plate and welding up to a 1/16" plate. The outfit can cut up to a 4" plate and weld up to a 1/2" plate with larger tips and acetylene cylinder.

Vendor Code: **HRR**

Catalog Number	Description	Price Each
<b>4400176</b>	Oxygen/Acetylene Welding/Cutting Torch Kit without Tanks	285.83

Accessories Include Goggles, Striker, 12-1/2" x 3/16" A to A Hose.

## WELDING / CUTTING TOOLS ACCESSORIES



4300834



SSW7

Vendor Code: **HRR**

Catalog Number	Description	Price Each
<b>4300418</b>	Replacement Flints for Striker	1.30
<b>4300834</b>	Flint Striker with Replaceable Flint	1.67
<b>4300833</b>	Tip Cleaner	3.55
<b>SSW7</b>	Silver Solder Flux 6.5 oz. Bottle	4.67
<b>1601775</b>	# 5 Welding Tip	17.17
<b>8808850</b>	MC-B Valve Adaptor	17.60
<b>8808851</b>	B-MC Valve Adaptor	17.60
<b>4531</b>	Safety-Silv 45% 1/16" x 1 t.o. pkg.	19.93
<b>5620F1</b>	Stay-Silv 5% .5 x 1/8" x 28" stick	35.12
<b>4533</b>	Safety-Silv 45% 1/16" x 3 t.o. pkg.	58.00
<b>45F3184</b>	Safety-Silv 45% 1/16" x 18" 4 oz. Nine Blue Sticks	68.60
<b>15620F1</b>	Stay-Silv 15% .50 x 1/8" x 28" stick	81.45

## LEAK REPAIR



Vendor Code: **ACQ**

Catalog Number	Description	Price Each
<b>LD8</b>	8 oz. Leak Detector	5.53
<b>FLT32</b>	32 oz. Spray Leak Detector	12.84
<b>AZEZPRO</b>	Ace Seal Leak Stop up to 1.5 Tons	41.58
<b>AZEZPRO+</b>	Ace Seal Leak Stop 1.5 Tons - 5 Tons	44.92

## CONTACTORS WITH LUGS



Vendor Code: **GBL**

Catalog Number	Amperage	Price Each
<b>3 POLES, 24V</b>		
<b>N4113</b>	30	17.87
<b>N4116</b>	40	25.30
<b>N4128</b>	50	56.12
<b>3 POLES, 120V</b>		
<b>N4114</b>	30	17.87
<b>N4117</b>	40	25.30
<b>N4129</b>	50	56.12
<b>N4135</b>	75	70.45
<b>3 POLES, 208/240V</b>		
<b>N4115</b>	30	17.87
<b>N4118</b>	40	25.30
<b>N4130</b>	50	56.12
<b>N4133</b>	60	62.90
<b>N4136</b>	75	70.45

## CONTACTORS WITH LUGS & QUAD QC

Vendor Code: **GBL**

Catalog Number	Amperage	Price Each
<b>1.5 POLES, 24V</b>		
<b>N4143</b>	30	7.78
<b>N4164</b>	40	10.08
<b>2 POLES, 24V</b>		
<b>N4104</b>	25	11.40
<b>N4107</b>	30	11.53
<b>N4161</b>	40	13.02
<b>2 POLES, 120V</b>		
<b>N4105</b>	25	11.40
<b>N4108</b>	30	11.53
<b>N4162</b>	40	13.02
<b>2 POLES, 208/240V</b>		
<b>N4106</b>	25	11.40
<b>N4109</b>	30	11.53
<b>N4163</b>	40	13.02

**CLEANERS**



CCL1

Vendor Code: **ACQ**

Catalog Number	Description	Price Each
<b>FEK32</b>	Foaming Non Rinse 32 oz. Spray Evap. Micro Channel	8.90
<b>FNA</b>	Foaming 20 oz. Aerosol Coil Cleaner	9.33
<b>FCA</b>	Foaming Evap. Coil Cleaner Non Acid 19 oz. Aerosol	10.42
<b>AEG32</b>	Evap Guard Coil & Drain Pan Disinfectant	11.00
<b>ECT32</b>	Eco-Treat 32 oz. Ductwork Odor Control Spray	13.83
<b>CCL1</b>	EVAP-Klean Evaporator Cleaner Non Rinse	15.05
<b>ABP1</b>	Ace Brite Premium Non Acid Condenser Coil Cleaner	19.25
<b>HPA</b>	10 oz. Aerosol Contact Cleaner	22.47
<b>DTJR</b>	Detergent Tabs Bottle of 200	23.25
<b>APFH05E</b>	Durable and Flexible 24" Charging Hose with Screw on Connections	24.97
<b>APFANZL</b>	II Injection Valve	28.45
<b>APFGUN</b>	Powerflush Injection Gun	37.34
<b>APF16</b>	16oz. Solvent Flush	55.42
<b>APFA1K</b>	Flush Solvent Pre-Pressurized 1# Can	123.67
<b>APFANZL</b>	Powerflush Kit 1# Pre-Pressurized Can W/Tools	36.67
<b>APFK</b>	Kit Injector Tool & 16 oz. Flush	140.67



**MISCELLANEOUS**



Telspoutoiler

TELSPOUTOILER - All-purpose lubricating oil that comes with a handy tel-spout oiler.

Vendor Code: **ACQ**

Catalog Number	Description	Price Each
<b>TELSPOUTOILER</b>	Extended Spout Oiler 4 oz.	2.22

**DUAL FILTER PLENUMS**

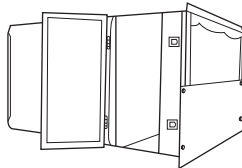

- Constructed of 26 GA ASTM-A653 CS Type B Galvanized Steel
- 1" Flange on All Four Sides for Easy Attachment
- Removable Track that Allows use of 1", 2", or 4" Filter
- Available Lined or Unlined- Must Specify the R Value of Liner
- Standard Height 30" Unless Otherwise Specified

Vendor Code: **DCT**

Catalog Number	Size	Price Each
<b>046R61620</b>	16" x 20" 1" & 4"	100.88
<b>046R61625</b>	16" x 25" 1" & 4"	102.98
<b>046R62025</b>	16" x 25" 1" & 4" 20" Side	116.50
<b>046R62520</b>	16" x 25" 1" & 4" 25" Side	123.73

**Please Note**

HVAC products are available only at select Elliott Electric Supply locations. Please contact your local rep for details.

Refrigerant and products which contain refrigerant will only be sold to individuals in possession of a valid EPA certification, or if a valid certification is on file for customer's account.

**REX RACKS**

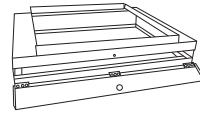

- Constructed of 26 GA ASTM-A653 CS Type B Galvanized Steel
- Removable Track that Allows use of 1", 4", or 4.5" Filter
- Starter Hole for Easy Cut Out
- 24 GA Hinged Door with Foam Gasket for Better Seal

Vendor Code: **DCT**

Catalog Number	Size	Price Each
<b>512025</b>	20" X 25" Door on 20" Side	40.37
<b>512520</b>	25" X 20" Door on 25" Side	40.37

**DRAIN PANS**

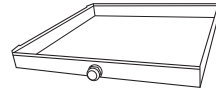

- Constructed of ASTM-A653 CS Type B Galvanized Steel
- One Piece Construction (No Sealer Needed)
- Folded Corners to Achieve a Water Proof Seal
- 3/4" PVC Drain Fitting
- 2 1/2" Deep Tapered Pan, Easily Stackable

Vendor Code: **DCT**

Catalog Number	Size	Price Each
<b>0601444</b>	14" X 44" Drain on 14"	17.40
<b>060L3048</b>	30" X 48" Drain on 48"	28.62
<b>060L3236</b>	32" X 36" Drain on 36"	25.73
<b>060L3060</b>	30" X 60" Drain on 60"	32.32

**90° ADJ SHEET METAL ELBOW**



Vendor Code: **DCT**

Catalog Number	Size	Price Each
<b>1254</b>	4"	2.55
<b>1255</b>	5"	2.62
<b>1256</b>	6"	2.53
<b>1257</b>	7"	3.33
<b>1258</b>	8"	3.83
<b>1259</b>	9"	5.97
<b>12510</b>	10"	6.07
<b>12512</b>	12"	8.80





### DAMPERS WITH TIPS

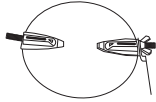

Vendor Code: **DCT**

Catalog Number	Size	Price Each
3004	4"	3.43
3005	5"	3.43
3006	6"	3.63
3007	7"	4.35
3008	8"	4.75
3009	9"	5.35
30010	10"	5.75
30012	12"	6.67

### UNCRIMPED REDUCERS



Vendor Code: **DCT**

Catalog Number	Size	Price Each
40045	5" X 4"	5.05
40046	6" X 4"	5.05
40056	6" X 5"	5.05
40067	7" X 6"	5.20
40068	8" X 6"	5.55
40078	8" X 7"	5.50
40079	9" X 7"	6.02
40089	9" X 8"	6.02
400810	10" X 8"	6.43
400910	10" X 9"	6.43

### FINGER SAVER START COLLAR

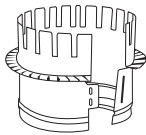

Vendor Code: **DCT**

Catalog Number	Size	Price Each
5254	4"	0.83
5255	5"	0.92
5256	6"	1.03
5257	7"	1.12
5258	8"	1.32
5259	9"	1.32
52510	10"	1.52
52512	12"	2.15
52514	14"	2.95
52516	16"	2.95
52518	18"	3.98
52520	20"	4.58

### BOOT R6 INSULATED SLANT TOP RAIL READY

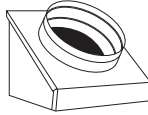

Vendor Code: **DCT**

Catalog Number	Size	Price Each
645R6485	8" X 4" X 5"	14.55
645R66106	10" X 6" X 6"	16.55
645R66127	12" X 6" X 7"	17.50
645R66128	12" X 6" X 8"	17.50
645R66148	14" X 6" X 8"	17.50
645R68107	10" X 8" X 7"	19.63
645R68108	10" X 8" X 8"	19.63
645R68128	12" X 8" X 8"	21.63
645R68149	14" X 8" X 9"	23.87
645R6121210	12" X 12" X 10"	27.60

### RAIL / LINE SET COVER

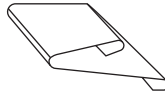

Vendor Code: **DCT**

Catalog Number	Size	Price Each
03826	Snap On Rails	0.60
093PWC54510	5" X 4" X 5" X 10' Line Set Cover	45.78

### WYES

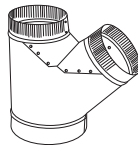

Vendor Code: **DCT**

Catalog Number	Size	Price Each
800655	6" X 5" X 5"	9.40
800755	7" X 5" X 5"	9.92
800866	8" X 6" X 6"	10.22
800876	8" X 7" X 6"	10.22
800975	9" X 7" X 5"	10.92
800977	9" X 7" X 7"	10.92
800986	9" X 8" X 6"	10.92
8001088	10" X 8" X 8"	12.42
8001096	10" X 9" X 6"	12.42
8001097	10" X 9" X 7"	12.42

### FILTER BASES

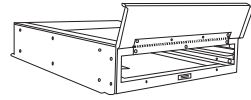

Vendor Code: **DCT**

Catalog Number	Size	Price Each
<b>GAS FURNACES</b>		
054G14254	14" X 25" 1" & 2" Filter 4" Tall	62.08
054G16254	16" X 25" 1" & 2" Filter 4" Tall	62.08
054G24244	24" X 24" 1" & 2" Filter 4" Tall	68.33
054G20254	20" X 25" 1" & 2" Filter 4" Tall	66.67
<b>ELECTRIC FURNACES</b>		
055E16204	16" X 20" 1", 2" & 4"	62.08
055E20204	20" X 20" 1", 2" & 4"	66.67
055E20254	20" X 25" 1", 2" & 4"	70.00
055E20254N	20" X 25" 1", 2" & 4" Door on 25" Side	71.67

### STRAPS

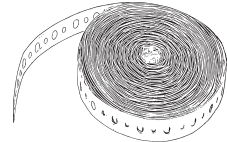

Vendor Code: **DCT (Cody Company)**

Catalog Number	Size	Price Each
<b>HANGER STRAPS</b>		
9902614	1.5" X 100' 26 Ga. Solid	24.78
9902	2" X 100' 26 Ga. Solid	25.93

Vendor Code: **DVV (Diversitech)**

Catalog Number	Size	Price Each
<b>HANGER STRAPS</b>		
710A1650	3/4" X 100' 28 Ga. Perforated	7.02
710001	1" X 100' 26 Ga. Solid	17.02
710005	1" X 100' 22 Ga. Solid	22.98
<b>WOVEN STRAPS</b>		
710100	1-3/4" X 100 Yards	6.73
710102	3" X 100 Yards	20.58



Mini-Split System

Heating, Ventilating & Air Conditioning

SMARTFLEX™ MINI-SPLIT SYSTEMS

Grow your business and solve more customer challenges with SmartFlex Mini-Split Systems. SmartFlex ductless systems deliver just the right amount of heating and cooling to every space while using no more energy than necessary. SmartFlex Mini-Split Systems are the ideal choice for applications that challenge traditional HVAC systems such as projects with varied loads and occupancy rates or cases where existing systems can't be modified to reasonably meet customer needs. A wide portfolio of equipment means SmartFlex Mini-Split Systems can be customized to meet the exact needs of your customers. With all of these advantages, isn't it time you brought the benefits of SmartFlex Mini-Split Systems home to your customers?

Benefits include:

- **Energy efficiency that traditional HVAC systems can't match**
  - High-efficiency, inverter-driven compressor modulates capacity to meet temperature requirements exactly
  - Energy-saving mode automatically selects optimal fan speed to reduce energy consumption
- **Exceptional comfort**
  - Unique temperature-sensing capability monitors room temperature at remote controller instead of indoor unit and adjusts airflow and temperature accordingly
  - Indoor fan automatically adjusts speed for maximum comfort
  - Pre-heating system ensures indoor fan doesn't run until coil has warmed to prevent cool air from circulating when in heating mode
- **Remarkably quiet operation**
  - sound pressure levels as low as 23 dB(A)

SMARTFLEX™ P SERIES  
HEAT PUMPS

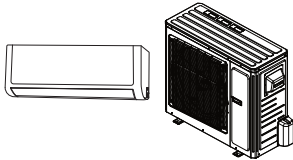

The slim and stylish 18 SEER Inverter Heat Pump system is built to last and offers intelligent controls.

- High-efficiency inverter technology
- Low ambient cooling to 0° F
- Auto swing (vertical)
- Multiple fan speeds
- Room temperature displayed on Wall-Mount Unit

Vendor Code: JCH

Catalog Number	BTU	SEER	Sizes	Price Each
<b>115V HP INDOOR</b>				
DHP09NWB11S	9K	16	1/4" & 3/8"	367.50
DHP12NWB11S	12K	16	1/4" & 3/8"	429.10
<b>115V HP OUTDOOR</b>				
DHP09CSB11S	9K	16	1/4" & 3/8"	688.10
DHP12CSB11S	12K	16	1/4" & 3/8"	761.60
<b>208/230V HP INDOOR</b>				
DHP09NWB21S	9K	16	1/4" & 3/8"	403.20
DHP12NWB21S	12K	16	1/4" & 3/8"	464.10
DHP18NWB21S	18K	16	1/4" & 1/2"	577.50
DHP24NWB21S	24K	16	1/4" & 5/8"	672.00
DHP30NWB21S	30K	18	1/4" & 5/8"	892.50
DHP36NWB21S	36K	18	1/4" & 5/8"	1076.60
<b>208/230V HP OUTDOOR</b>				
DHP09CSB21S	9K	16	1/4" & 3/8"	931.70
DHP12CSB21S	12K	16	1/4" & 3/8"	1008.70
DHP18CSB21S	18K	16	1/4" & 1/2"	1143.10
DHP24CSB21S	24K	16	1/4" & 5/8"	1244.67
DHP30CSB21S	30K	18	1/4" & 5/8"	1549.10
DHP36CSB21S	36K	18	1/4" & 5/8"	1804.60



SMARTFLEX™ P SERIES  
COOLING ONLY

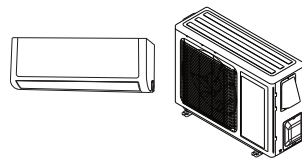

Vendor Code: JCH

Catalog Number	BTU	Size	SEER	Price Each
<b>115V HP INDOOR</b>				
DCP12NWB11S	12K	1/4" X 3/8"	16	388.50
<b>115V HP OUTDOOR</b>				
DCP12CSB11S	12K	1/4" X 3/8"	16	705.60

PREASSEMBLED MINI-SPLIT LINE SETS

Vendor Code: DVV

Catalog Number	Length	Liquid x Suction	Installation Thickness	Price Each
D40620250B3B6	25'	1/4" x 3/8"	1/2"	84.05
D40620350B3B6	35'	1/4" x 3/8"	1/2"	108.45
D40620500B3B6	50'	1/4" x 3/8"	1/2"	144.38
D41020250B3B6	25'	1/4" x 5/8"	1/2"	107.52
D41020350B3B6	35'	1/4" x 5/8"	1/2"	140.47
D41020500B3B6	50'	1/4" x 5/8"	1/2"	190.15

\*Required in all Mini-Split Installations.

MINI-SPLIT CABLE

Vendor Code: BUW

Catalog Number	AWG	Conductors	Length	Price per 1,000 feet
PWT14450	14	4	50'	612.67
PWT144250	14	4	250'	612.67



Motor Control

H

SECTION



# Motor Control



## Motor Control

### Starters

NEMA .....	H3–H4
IEC .....	H5
Variable Speed, Adjustable Frequency Drives .....	H6
Soft Starters .....	H7
Pump Panels .....	H8
Contactors .....	H8–H9

### Pushbuttons, Limit Switches

30 mm .....	H10
Pushbutton Stations .....	H11
22.5 mm .....	H12–H13
Limit Switches .....	H14

### Automation

ELC Programmable Logic Controllers .....	H15
HMIs .....	H15
Sensors .....	H16–H19

### Power Supplies, Relays, Monitors

Power Supplies .....	H20
Relays .....	H20–H23
Monitors .....	H21

### DIN Rail

Circuit Breakers .....	H24
Terminal Blocks .....	H24–H25
Ground Blocks .....	H25

### Signaling

Fire Alarms .....	H26
Transformers .....	H26
Beacon Lights, Bells, Buzzers, Horns .....	H26



## NEMA 3-Phase Freedom Starters · Heater Packs

### NEMA 3-PHASE FREEDOM STARTERS



Solid State Overload

- Accelerated trip protects against phase loss
- Straight-through wiring
- Horizontal or vertical mounting
- Top located coil terminals convenient and readily accessible
- Size 1 and larger have encapsulated magnet coils

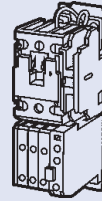

Bimetallic Overload

### ENCLOSED STARTERS WITH SOLID STATE OVERLOAD RELAY NO HEATERS REQUIRED

- **No heater coils required**
- Broad Full Load Amps (FLA) range 0.33-1500 A
- Phase loss and selectable phase imbalance protection
- Selectable trip class with manual or auto reset
- Low energy consumption for cooler operation
- Available add on accessories like remote reset and communication modules - DeviceNet Profibus Modules

Vendor Code: **CHC**

Catalog Number	NEMA Size	Maximum HP		Trip Range	Price Each
		@230V	@460V		
<b>120 VOLT COILS</b>					
<b>ECN05A1AAAR63B</b>	00	1-1/2	2	1-5	513.61
<b>ECN0501AAAR63C</b>	0	3	5	4-20	388.38
<b>ECN0511AAAR63C</b>	1	7-1/2	10	4-20	435.45
<b>ECN0511AAAR63D</b>	1	7-1/2	10	9-45	548.26
<b>ECN0521AAAR63D</b>	2	15	25	9-45	822.01
<b>ECN0531AAAR63E</b>	3	30	50	20-100	1332.25
<b>ECN0541AAAR63F</b>	4	50	100	20-140	2927.39
<b>ECN0551AAAR63G</b>	5	100	200	60-300	9460.25

Character (in **Bold and Black**) of Catalog Number Designates Coil Voltage. **A = 120V, B = 240V and C = 480V.**

### OPEN STARTERS WITH SOLID STATE OVERLOAD RELAY

Vendor Code: **CHC**

Catalog Number	NEMA Size	HP Rating		Trip Range	Price Each
		@230V	@460V		
<b>120 VOLT COILS</b>					
<b>AN19ANO5E005</b>	00	1-1/2	2	1-5	324.44
<b>AN19BNO5E020</b>	0	3	5	4-20	390.77
<b>AN19DNO5E020</b>	1	7-1/2	10	4-20	448.25
<b>AN19DNO5E045</b>	1	7-1/2	10	9-45	499.90
<b>AN19GNO5E045</b>	2	15	25	9-45	787.06
<b>AN19KNO5E100</b>	3	30	50	20-100	1225.42
<b>AN19NNO5E140</b>	4	50	100	20-140	3957.95
<b>AN19SNO5E300</b>	5	100	200	60-300	5637.95

Character (in **Bold and Black**) of Catalog Number Designates Coil Voltage. **A = 120V, B = 240V and C = 480V.**



### ENCLOSED STARTERS WITH BIMETALLIC OVERLOAD RELAY

Vendor Code: **CHC**

Catalog Number	NEMA Size	Maximum HP		Overload Relay Size**	Price Each
		@230V	@460V		
<b>NON-REVERSING STARTER IN NEMA TYPE 1 ENCLOSURE, 120V COIL</b>					
<b>ECN05A1AAA</b>	00	1-1/2	2	32A	336.54
<b>ECN0501AAA</b>	0	3	5	32A	413.47
<b>ECN0511AAA</b>	1	7-1/2	10	75A	467.16
<b>ECN0521AAA</b>	2	15	25	75A	948.62
<b>ECN0531AAA</b>	3	30	50	105A	1408.37
<b>ECN0541AAA</b>	4	50	100	144A	3126.22
<b>REVERSING STARTER IN NEMA TYPE 1 ENCLOSURE, 120V COIL</b>					
<b>ECN0601AAA</b>	0	3	5	32A	1177.18
<b>ECN0611AAA</b>	1	7-1/2	10	75A	1344.16

Available to NEMA Size 8. Choose Heater Packs (Sold Separately) from Table Below. Character (in **Bold and Black**) of Catalog Number Designates Coil Voltage. **A = 120V, B = 240V and C = 480V.**

### HEATER PACKS FOR OVERLOAD RELAYS INCLUDES THREE HEATERS

Vendor Code: **CHC**

For Use With NEMA Size	Overload Relay Size	Motor Full Load Ampere Rating				Includes 3 Heaters		
		Dial Positions				Catalog Number	Price Each	
		A	B	C	D			
00 0 1 4	32A	0.560	0.676	0.791	0.907	<b>H2003B3</b>	79.06	
		0.814	0.983	1.15	1.32	<b>H2004B3</b>	79.06	
		1.20	1.45	1.71	1.96	<b>H2005B3</b>	79.06	
		1.79	2.16	2.53	2.90	<b>H2006B3</b>	79.06	
		2.15	2.60	3.04	3.49	<b>H2007B3</b>	79.06	
		3.23	3.90	4.56	5.23	<b>H2008B3</b>	79.06	
	2	75A	4.55	5.50	6.45	7.40	<b>H2009B3</b>	79.06
			6.75	8.17	9.58	11.0	<b>H2010B3</b>	79.06
			9.14	10.8	12.4	14.0	<b>H2011B3</b>	79.06
			14.0	16.9	19.9	22.8	<b>H2012B3</b>	79.06
			18.7	22.7	26.7	30.7	<b>H2013B3</b>	79.06
			23.5	28.5	33.5	38.5	<b>H2014B3</b>	79.06
3 4	105A 144A	29.0	34.0	39.1	44.1	<b>H2015B3</b>	79.06	
		39.6	45.5	51.5	57.4	<b>H2016B3</b>	79.06	
		53.9	60.9	67.9	74.9	<b>H2017B3</b>	79.06	
		18.0	20.2	22.3	24.5	<b>H20183</b>	79.50	
		24.6	27.6	30.5	33.4	<b>H20193</b>	79.06	
		33.5	37.5	41.5	45.6	<b>H20203</b>	79.06	
		45.7	51.2	56.7	62.1	<b>H20213</b>	79.06	
		62.2	69.7	77.1	84.6	<b>H20223</b>	79.06	
		84.7	95.0	105.0	115.0	<b>H20233</b>	79.06	
		106.0	118.0	131.0	144.0	<b>H20243</b>	79.06	

Motor Control





NEMA Contactor Accessories (Magnetic Coils · Overload Relays · Contact Kits)

"FREEDOM" SERIES  
MAGNETIC COILS

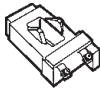

Vendor Code: **CHC**

Catalog Number	NEMA Size	Voltage @60Hz	Price Each
928751	00	120	213.61
928752	00	240	213.61
928753	00	480	213.61
928761	0	120	213.61
928762	0	240	213.08
928763	0	480	206.92
932856	1-2	24	211.71
932851	1-2	120	262.85
932852	1-2	240	259.79
927033	1-2	480	206.46
927566	3	24	409.46
927561	3	120	407.90
927562	3	240	394.62
927563	3	480	394.62
9189115	4-5	24	443.09
918911	4-5	120	407.79
918913	4-5	480	407.79

OVERLOAD RELAYS



Vendor Code: **CHC**

Catalog Number	For NEMA Size Contactors	Overload Relay Size	Max. Amps	Price Each
<b>WITHOUT HEATER PACKS*</b>				
C306DN3B	00 - 0, 5 and Above**	32A	32	184.82
C306GN3B	1-2	75A	75	316.71
C306KN3	3	105A	105	448.66
C306NN3	4	144A	144	616.93

\*Choose Heater Packs for Overload Relay (Sold Separately) from Table on Page H3 to Complete.

\*\*NEMA Contactors Size 5 and Above Use a 32A Overload Relay, in Conjunction with a Current Transformer.

AUXILIARY CONTACTS

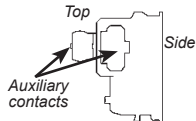

Vendor Code: **CHC**

Catalog Number	For NEMA Size Contactors	Mounting Position	Contacts	Price Each
C320KGS1	00-2	Side	1 NO	59.69
C320KGS2	00-2	Side	1 NC	59.69
C320KGS3	00-2	Side	1 NO, 1 NC	81.19
C320KGS4	00-2	Side	2 NO	81.19
C320KGT1	00-2	Top	1 NO	59.69
C320KGT2	00-2	Top	1 NC	55.02
C320KGT3	00-2	Top	1 NO, 1 NC	72.36
C320KGT4	00-2	Top	2 NO	86.80
C320KGS20	3-5	Side	1 NO	109.55
C320KGS21	3-5	Side	1 NC	109.55
C320KGS22	3-5	Side	1 NO, 1 NC	162.42

"FREEDOM" SERIES  
CONTACT KITS



Vendor Code: **CHC**

Catalog Number	NEMA Size	Price Each
<b>THREE POLE</b>		
6652	1	344.33
6658	2	599.64
6436	3	971.24
6442	4	2082.86
6452	5	3517.85

COVER CONTROL KITS

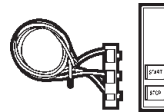

Vendor Code: **CHC**

Catalog Number	NEMA Size	Description	Price Each
C400GK1	00-4	Start / Stop Pushbuttons	171.92
C400GK3	00-4	H-0-A Selector Switch	171.92

MECHANICAL INTERLOCK KIT

Vendor Code: **CHC**

Catalog Number	NEMA Size	Description	Price Each
C321KM60B	00-2	Mechanical Interlock Kit	48.24

REVERSING DRUM SWITCH  
1 OR 3 PHASE

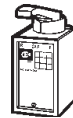

Vendor Code: **CHC**

Catalog Number	Maximum HP				Price Each
	Single Phase		Three Phase		
	@115V	@230V	@230V	@460V	
<b>FIELD CONVERTIBLE, MAINTAINED OR MOMENTARY</b>					
9441H268	1-1/2	2	2	2	159.17





## IEC 3-Phase XT Series Contactors and Starters · Electronic Overloads

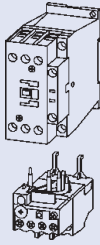

### IEC 3-PHASE XT SERIES CONTACTORS & STARTERS

Eaton's new line of XT Contactors and Starters include non-reversing and reversing contactors, overload relays and a variety of related accessories. Because XT meets IEC, UL, CSA, CCE and CE standards, it is the perfect product solution for IEC applications all over the world. The compact, space saving, and easy to install XT line of IEC contactors and starters is the efficient and effective solution for your application from 7A to 2000A.

- AC control from 12V to 600V 50/60Hz
- DC control from 12V to 220V
- Available with screw or spring cage terminals
- Reversing or non-reversing contactors and starters
- AC-3 contactor ratings to 1000A
- Non-Reversing starters to 650A
- Panel or DIN rail mounting to 65A
- IP20 finger and back-of-hand proof
- Built-in NO or NC auxiliary contacts to 32A
- Available with XT0B bimetallic or XT0E solid-state overload relay
- Phase failure or phase unbalance protection

### THREE PHASE CONTACTORS OPEN TYPE NON-REVERSING

Vendor Code: **CHC**

Catalog Number	Frame Size	Amps AC-3	Max. HP (UL/CSA)		Auxiliary Contacts	Price Each
			@230V	@460V		
XTCE009B10A	B	9	3	5	1NO	53.53
XTCE012B10A	B	12	3	10	1NO	64.51
XTCE015B10A	B	15	5	10	1NO	71.49
XTCE025C10A	C	25	10	15	1N	89.11
XTCE032C10A	C	32	10	20	1NO	111.39
XTCE065DS1A	D	65	25	50	1NO SIDE	177.89
XTCE072DS1A	D	72	25	50	1NO SIDE	562.62
XTCE080FS1A	F	80	30	60	1NO SIDE	219.78
XTCE095FS1A	F	95	40	75	1NO SIDE	312.00
XTCE115GS1A	G	115	50	100	1NO SIDE	381.60
XTCE150GS1A	G	150	50	100	1NO SIDE	539.83
XTCE170GS1A	G	170	60	125	1NO SIDE	1563.23
XTCE185H22A	H	185	60	125	2NO 2NC TOP	1299.70
XTCE225H22A	H	225	75	150	2NO 2NC TOP	1455.50
XTCE250L22A	L	250	100	200	2NO 2NC TOP	2794.15
XTCE300L22A	L	300	125	250	2NO 2NC TOP	2857.02

AC-3: Squirrel-Cage Motors; Starting or Switching of Motors While Running.  
Catalog Numbers Listed Above have 120V Coil Voltage (A).  
Replace A with B for 240V, C for 480V, or T for 24V.

### ELECTRONIC OVERLOADS

Vendor Code: **CHC**

Catalog Number	Frame Size	Adjustable FLA Range	Price Each
XT0E005BCS	B	1 - 5A	77.99
XT0E020BCS	B	4 - 20A	77.99
XT0E020CCS	C	4 - 20A	97.13
XT0E045CCS	C	9 - 45A	93.75
XT0E045DCS	D	9 - 45A	225.43
XT0E100DCS	D	20 - 100A	297.30
XT0E175GCS	G-H	35 - 175A	414.07

Mount Directly to Contactor  
All Overloads Have 1NO and 1NC Contact

### REPLACEMENT COILS

Vendor Code: **CHC**

Catalog Number	Frame	Voltage	Price Each
XTCERENC0ILCA	C	120V	93.61
XTCERENC0ILD A	D	120V	119.58
XTCERENC0ILFA	F	120V	144.87
XTCERENC0ILGA	G	120V	237.80
XTCERENC0ILHA	H	120V	410.68
XTCERENC0ILLA	L	120V	694.27

Character (in Black) of Catalog Number Designates Voltage.  
Catalog Numbers Listed Above have 120V Coil Voltage (A).  
Replace A with B for 240V, or C for 480V.

### BI-METAL OVERLOADS

Vendor Code: **CHC**

Catalog Number	Frame Size	Adjustable Range	Price Each
XT0B004BC1	B	2.4 - 4	93.48
XT0B006BC1	B	4 - 6	220.85
XT0B010BC1	B	6 - 10	80.80
XT0B012BC1	B	9 - 12	45.60
XT0B016BC1	B	12 - 16	45.68
XT0B016CC1	C	10 - 16	76.58
XT0B024CC1	C	16 - 24	48.80
XT0B032CC1	C	24 - 32	117.26
XT0B040DC1	D	24 - 40	115.18
XT0B057DC1	D	40 - 57	82.40
XT0B065DC1	D	50 - 65	82.40
XT0B050GC1	F, G	35 - 50	275.94
XT0B070GC1	F, G	50 - 70	275.08
XT0B100GC1	F, G	70 - 100	152.50
XT0B125GC1	F, G	95 - 125	408.73
XT0B150GC1	F, G	120 - 150	216.50
XT0B175GC1	F, G	145 - 175	190.00
XT0B160HC1	H	120 - 160	480.00
XT0B220HC1	H	160 - 220	393.60
XT0B250HC1	H	200 - 250	393.60
XT0B160LC1	L	120 - 160	558.50
XT0B220LC1	L	160 - 220	580.50
XT0B250LC1	L	200 - 250	519.06
XT0B300LC1	L	200 - 300	515.28

All Are Direct Mount Except for Frames H and L  
All Overloads Have 1NO and 1NC Contact

### AUXILIARY CONTACTS

Vendor Code: **CHC**

Catalog Number	Frame Size	Contacts	Mounting	Price Each
XTCEXSAB10	B	1NO	Side Mount	16.94
XTCEXSAB01	B	1NC	Side Mount	16.94
XTCEXSCC11	C	1NO 1NC	Side Mount	58.42
XTCEXSBN11	D-H	1NO 1NC	Side Mount	58.43
XTCEXSBR11	L-R	1NO 1NC	Side Mount	58.42
XTCEXFATC20	B-C	2NO	Top Mount	29.55
XTCEXFATC11	B-C	1NO 1NC	Top Mount	31.76
XTCEXFATC02	B-C	2NC	Top Mount	29.55

Other Configurations Available



Motor Control  
H



Variable Speed Starters · Adjustable Frequency Drives

**VARIABLE SPEED STARTERS**  
POWERXL SERIES  
- DE1, 1/2 - 10HP

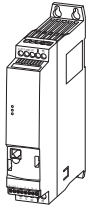

Eaton's DE1 variable speed starter (VSS) is a device that offers the user friendly and ease of use of a start and the adjustable frequency of a drive. The DE1 is the market's first VSS designed for basic motor controlling applications in a slim footprint for high density enclosures.

- Simplistic, cost effective design with no keypad
- 2 frame sizes in 45mm and 90mm widths
- Modbus on board
- Smartwire-DT connectivity
- Intuitive configuration module to change up to 5 parameters
  - Motor current
  - Motor frequency
  - Control terminal configuration
  - Fixed frequency
  - Ramp time
- Connectivity with drivesConnect PC Tool with PC Cable or Bluetooth module
- Overload rating: 150% constant torque for 60 seconds.

Vendor Code: **CHC**

Catalog Number	Constant Torque HP	Frame Size	Price Each
<b>230V, SINGLE PHASE TO THREE PHASE</b>			
DE1124D3NNN20N	1	1	201.04
DE1127D0NNN20N	2	1	212.94
DE1129D6NNN20N	3	2	310.96
<b>460V, THREE PHASE</b>			
DE1345D0NNN20N	3	2	345.60
DE1348D5NNN20N	5	2	321.17
DE134011NNN20N	7.5	2	496.47
DE134016NNN20N	10	2	582.95
<b>ACCESSORIES</b>			
DXEEXTSET	Config. Module		53.53
DXCOMSTICK3	Bluetooth Stick		223.32

**ADJUSTABLE FREQUENCY DRIVES**  
POWERXL SERIES—DC1, 1/2 - 15HP,  
1/2 - 15HP 240V, 1 - 30HP 480V

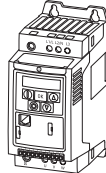

Eaton's DC1 adjustable frequency drives are engineered for today's OEM and MRO applications. This series of drives offers a compact space saving design that is perfect for panel builders or as a replacement for across the line motor starters.

- 14 basic programming parameters for quick commissioning
- Brake chopper standard standard in frames 2 and higher
- SmarWire-DT™ connectivity
- Available in IP20 or IP66 configuration
- Overload rating: 150% constant torque (IL) for 60 seconds
- Standard Communications: RS-485/Modbus® and CANopen™
- Coated boards
- Integrated PI Controller

Vendor Code: **CHC**

Catalog Number	Constant Torque HP	Frame Size	Price Each
<b>230V, SINGLE PHASE IN - THREE PHASE OUT</b>			
DC1127D0NBA20CE1	2	2	593.00
DC112011NBA20CE1	3	2	619.00
DC112015NBA20CE1	5	3	616.50
<b>230V, THREE PHASE</b>			
DC1327D0NBA20CE1	2	2	343.95
DC132011NBA20CE1	3	2	365.06
DC132018NBA20CE1	5	3	715.50
DC132030NBA20CE1	10	4	740.72
DC132046NBA20CE1	15	4	1048.50
<b>460V, THREE PHASE</b>			
DC1344D1NBA20CE1	2	2	325.13
DC1345D8NBA20CE1	3	2	418.50
DC1349D5NBA20CE1	5	2	869.00
DC134014NBA20CE1	7.5	3	754.88
DC134018NBA20CE1	10	3	885.38
DC134024NBA20CE1	15	3	943.31
DC134030NBA20CE1	20	4	834.10
DC134039NBA20CE1	25	4	1390.60
DC134046NBA20CE1	30	4	1484.11

Models Shown are IP20 Configuration. IP66 Configurations also Available.

**ADJUSTABLE FREQUENCY DRIVES**  
POWERXL SERIES—DG1, 3/4 - 200HP

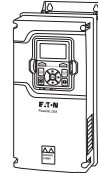

The DG1 general purpose drives are part of Eaton's next generation of adjustable frequency drives. Robust and highly modular, these drives can be flexibly adapted to meet most customers' needs.

- Graphic LCD display and keypad
- Quick start wizard upon initial power-up supports fast, easy installation
- Standard applications: Standard, Multi-pump and fan control, Multi-PID and Multi-purpose
- Brake chopper standard
- Dual overload ratings: 110% variable torque (IL), 150% constant torque (IL)
- Standard I/O: 8DI, 1DO, 2AI, 2AO, Three Relays
- Communications: EtherNet/IP, Modbus TCP RS-485; Modbus RTU, BACnet MS/TP
- Available through 1,000 HP
- Coated Boards Standard

Vendor Code: **CHC**

Catalog Number	Constant Torque HP	Variable Torque HP	Price Each
<b>THREE PHASE, 208-240 VOLT</b>			
DG1327D8FBC21C	2	3	565.47
DG132011FBC21C	3	3	632.04
DG132012FBC21C	4	5	654.15
DG132017FBC21C	5	7.5	758.95
DG132025FBC21C	7.5	10	853.39
DG132031FBC21C	10	15	983.14
DG132048FBC21C	15	20	1223.45
DG132061FBC21C	20	25	1702.16
<b>THREE PHASE, 380-500 VOLT</b>			
DG1344D3FBC21C	2	3	627.66
DG1345D6FBC21C	3	5	670.66
DG1347D6FBC21C	5	6	816.53
DG134012FBC21C	7.5	10	906.36
DG134016FBC21C	10	15	971.24
DG134023FBC21C	15	20	1129.02
DG134031FBC21C	20	25	1539.01
DG134038FBC21C	25	30	1713.30
DG134046FBC21C	30	40	2095.27
DG134061FNC21C	40	50	2721.00
DG134072FNC21C	50	60	3259.97
DG134087FNC21C	60	75	3558.66
DG134105FNC21C	75	100	4363.67
DG134140FNC21C	100	125	5461.97
DG134170FNC21C	125	150	6044.72

Bold "B" Denotes Models with Build in Brake Chopper

Motor Control

H







### SOFT STARTERS

S811+ SERIES — 10 - 700HP

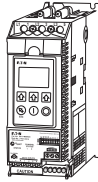

Eaton's line of S811+ Soft Starters is compact, multi-functional, and easy to install. Designed to control acceleration and deceleration of three-phase motors up to 690V, the line is available from 11A to 1000A. S811+ series soft starters include Digital Interface Module that allows user to configure device and may be removed for remote mounting if necessary.

- Variable ramp times and torque control settings provide unlimited starting and stopping configurations for maximum flexibility
- Wide range of overload settings (31%-100% of rated current) and selectable trip class (5-30)
- Removable Digital Interface Module may be remote mounted or used to copy programming between units
- 24Vdc control voltage for operator safety
- Built in motor overload protection included. All protective features can be configured, enabled or disabled to meet any application
- Modbus RTU communications is standard but may connect to a variety of communications networks including:
  - DeviceNet
  - Modbus TCP
  - EtherNet/IP
  - PROFIBUS

Vendor Code: **CHC**

Catalog Number	Frame Size	HP Rating		Price Each
		@230V	@460V	
<b>STANDARD DUTY - 15 SEC. RAMP, 300% CURRENT LIMIT @ 40°C, 1.0SF</b>				
<b>S811+N37N3S</b>	N	10	25	1621.90
<b>S811+N66N3S</b>	N	20	50	2491.48
<b>S811+R10N3S</b>	R	30	60	3761.62
<b>S811+R13N3S</b>	R	40	75	4677.47
<b>S811+T18N3S</b>	T	60	125	4875.20
<b>S811+T24N3S</b>	T	75	150	5194.02
<b>S811+T30N3S</b>	T	100	200	8284.00
<b>S811+V36N3S</b>	V	125	250	6857.74
<b>S811+V42N3S</b>	V	150	300	7710.21
<b>S811+V65N3S</b>	V	200	450	9329.58
<b>S811+V72N3S</b>	V	250	500	14239.85

Requires 24Vdc Power Supply: **Page H20**  
Sizes Available up to 700hp at 575V



### IEC MANUAL MOTOR STARTERS XT SERIES



Vendor Code: **CHC**

Catalog Number	Frame Size	Adjustable FLA Range*	Maximum HP, 3-Phase		Price Each
			@230V	@460V	
<b>XTPR2P5BC1</b>	B	1.6 – 2.5	1/2	1	150.12
<b>XTPR004BC1</b>	B	2.5 – 4.0	1	2	150.12
<b>XTPR6P3BC1</b>	B	4.0 – 6.3	1-1/2	3	150.12
<b>XTPR010BC1</b>	B	6.3 – 10.0	3	7-1/2	150.12
<b>XTPR020BC1</b>	B	16 – 20	5	10	179.14
<b>XTPR025BC1</b>	B	20 – 25	7-1/2	15	179.14

\*Service Factor Less Than 1.15, Multiply 0.9 by Nameplate FLA.  
Products listed above have Rotary style handles. Replace Character (in **Bold and Black**) of Catalog Number with **B** for Pushbutton Manual Motor Starter.

### AUXILIARY CONTACTS FOR XT SERIES MANUAL MOTOR STARTERS

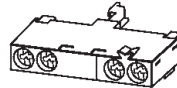

Vendor Code: **CHC**

Catalog Number	Mounting Position	Auxiliary Contacts	Price Each
<b>XTPAXFA11</b>	Front Mount	1 NO, 1 NC	13.28

Motor Control

H



FUSIBLE NEMA TYPE 3R ENCLOSURE  
PUMP PANELS

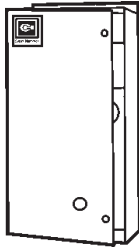

- Solid State Overload
- No heater coils required - **Reduces cost by \$68.21**
- Broad Full Load Amps (FLA) range 0.33-1500 A
- Phase loss and selectable phase imbalance protection
- Selectable trip class with manual or auto reset
- Low energy consumption for cooler operation
- Available add on accessories like remote reset and communication modules - DeviceNet Profibus Modules

Vendor Code: **CHC**

Catalog Number	NEMA Size	Maximum HP		Adjustable Solid State Overload Relay (Amps)	Price Each
		@230V	@460V		
<b>HOA, NO PB, NARROW, WITHOUT FUSE CLIPS</b>					
<b>ECN5412AACP6R63C</b>	1	7-1/2	10	4.0 – 20	799.61
<b>ECN5422AAEP6R63D</b>	2	15	25	9.0 – 45	945.86
<b>ECN5432AAGP6R63E</b>	3	30	50	20.0 – 100	999.63
<b>ECN5442AAJP6R63F</b>	4	50	100	60 – 300	1832.12
<b>ECN5452AALP6R63G</b>	5	100	200	60 – 300	3706.62
<b>HOA, PB, STANDARD WIDTH, WITHOUT FUSE CLIPS</b>					
<b>ECN5412CACR63C</b>	1	7-1/2	10	4.0 – 20	502.96
<b>ECN5422CAER63D</b>	2	15	25	9.0 – 45	684.02
<b>ECN5432CAGR63E</b>	3	30	50	22.0 – 100	939.98
<b>ECN5442CAJR63F</b>	4	50	100	60 – 300	1881.25
<b>ECN5452CALR63G</b>	5	100	200	60 – 300	3380.90
<b>HOA, NO PB, VACUUM CONTACTORS, WITHOUT FUSE CLIPS</b>					
<b>ECV5442AAJP6R63F</b>	4	50	100	30.0 – 150.0	11009.11
<b>ECV5452AALP6R63G</b>	5	100	200	1.0 – 5.0	6286.00

Character (in Bold and Black) of Catalog Number Designates Coil Voltage.  
**A = 120V, B = 240V and C = 480V.**  
 Choose Fuse Clips (Sold Separately) from Table to the Right.

VACUUM CONTACTORS

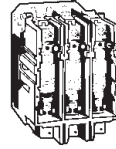

- Contacts located inside sealed ceramic tubes for intrinsically safe protection.
- Arc is extinguished when passing through zero for excellent contact life.

Vendor Code: **CHC**

Catalog Number	NEMA Size	Volts	Amps	Price Each
<b>VACUUM CONTACTORS</b>				
<b>V201K4CJ</b>	4	120	135	5501.58
<b>V201K5CJZ1</b>	5	120	270	15456.90
<b>SIZE 4-8 SOLID STATE OVERLOAD RELAY</b>				
<b>C440A1A005SAX</b>	4 – 8	Requires Transformer Kit (Below)		119.94
<b>ZEBXCT300</b>	4 – 8 Current Transformer Kit			388.93

FUSE CLIPS

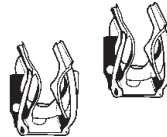

Vendor Code: **CHC**

For Use with NEMA Starter Size	Motor Volts	Fuse Size Amps / Volts	Catalog Number	Price Each
<b>1</b>	200 / 230	30 / 250	<b>C351KC21R</b>	21.83
	460 / 575	30 / 600	<b>C351KD2261R</b>	39.20
<b>2</b>	200 / 230	60 / 250	<b>C351KD2261R</b>	39.20
	460 / 575	60 / 600	<b>C351KD62R</b>	33.12
<b>3</b>	200 / 230	100 / 250	<b>C351KE2363</b>	86.27
	460 / 575	100 / 600	<b>C351KE2363</b>	86.27
<b>4</b>	200 / 230	200 / 250	<b>C351KF2464</b>	134.45
	460 / 575	200 / 600	<b>C351KF2464</b>	134.45





**DEFINITE PURPOSE CONTACTORS**  
**C25 SERIES**

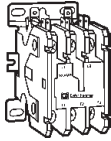

Vendor Code: **CHC**

Catalog Number	Inductive Amps	Resistive Amps	Price Each
<b>TWO-POLE, 120V COIL</b>			
<b>C25BNB230A**</b>	30**	40	27.46
<b>C25DND230A</b>	30	40	64.25
<b>C25DNF240A</b>	40	50	76.30
<b>C25FNF260A</b>	60	75	125.52
<b>THREE-POLE, 120V COIL</b>			
<b>C25DND330A</b>	30	40	61.56
<b>C25DNF340A</b>	40	50	71.56
<b>C25FNF350A</b>	50	65	114.52
<b>C25FNF360A</b>	60	75	154.96
<b>FOUR-POLE, 120V COIL</b>			
<b>C25END430A</b>	30	40	73.71
<b>C25ENF440A</b>	40	50	84.85

Character (in Bold and Black) of Catalog Number Designates Coil Voltage.  
**A** = 120V, **T** = 24V,  
**B** = 240V, **C** = 480V, and **H** = 277V.  
 \*\*Coil Cannot be Changed.

**ACCESSORIES FOR C25 SERIES**  
**AUXILIARY CONTACTS AND INTERLOCKS**

Vendor Code: **CHC**

Catalog Number	Description	Price Each
<b>AUXILIARY CONTACTS*</b>		
<b>C320KG1</b>	1 NO Auxiliary Contact	34.62
<b>C320KG2</b>	1 NC Auxiliary Contact	34.62
<b>C320KG3</b>	1 NO, 1 NC Auxiliary Contact	56.68
<b>MECHANICAL INTERLOCK KIT</b>		
<b>C321KM60B</b>	For Reversing Applications	48.24

\*Auxiliary Contacts Not Designed to Fit C25BNB Contactors.

**REPLACEMENT COILS**

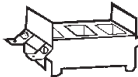

Vendor Code: **CHC**

Catalog Number	Voltage	Price Each
<b>FOR 30 – 40 AMP CONTACTORS</b>		
<b>931256</b>	24	101.65
<b>931251</b>	120	100.89
<b>931252</b>	240	95.59
<b>931253</b>	480	100.89
<b>FOR 40 – 60 AMP CONTACTORS</b>		
<b>932561</b>	120	123.65
<b>932562</b>	208 – 240	124.45

**LIGHTING CONTACTORS**  
**ELECTRICALLY HELD CN35 SERIES**

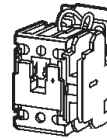

Vendor Code: **CHC**

Catalog Number	Amps	Poles	Price Each
<b>120V AC COIL, OPEN</b>			
<b>CN35BN2AB</b>	20	2	457.28
<b>CN35BN3AB</b>	20	3	512.14
<b>CN35DN2AB</b>	30	2	544.35
<b>CN35DN3AB</b>	30	3	612.39

**MECHANICALLY HELD**

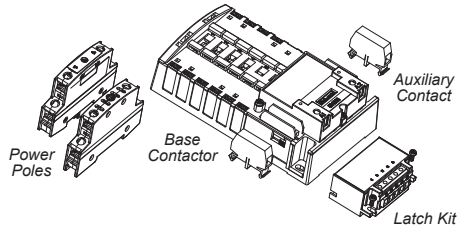

Vendor Code: **CHC**

Catalog Number	Description	Price Each
<b>BASE CONTACTORS*</b>		
<b>C30CNE20A0</b>	2 NO, 120V AC Base	313.19
<b>LATCH KITS**</b>		
<b>C320MH3WA0</b>	Three Wire Latch Kit	300.96
<b>POWER POLES</b>		
<b>C320PRP1</b>	Single Pole, 30A	128.10
<b>C320PRP2</b>	Two Pole, 30A	252.68
<b>AUXILIARY CONTACTS</b>		
<b>C320AMH1</b>	Single Pole Auxiliary Contact	46.61
<b>C320AMH2</b>	Two Pole Auxiliary Contact	70.50

\*Base Contactor is Electrically Operated.  
 \*\*Latch Kit is Required to be Mechanically Held up to 12 Poles Maximum.

Motor Control  
H





30mm Full Size Operators NEMA Rated Types 1, 2, 3, 3R, 4, 4X, 12 and 13

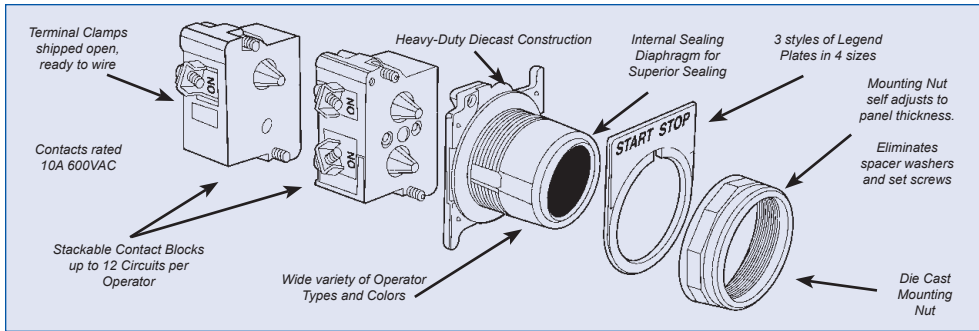

**PUSHBUTTON AND INDICATOR LIGHT ASSEMBLIES**

Vendor Code: **CHC**

Catalog Number	Description	Price Each
<b>NON-ILLUMINATED PUSHBUTTON ASSEMBLIES</b>		
10250T31RP0P	Extended Red Pushbutton	75.97
10250T30BP0P	Flush Black Pushbutton	79.15
10250T5B621P0P	Red Push-Pull	139.67
10250T32RP0P	Red Mushroom Pushbutton	124.03
10250T33P0P	Red Jumbo Mushroom Pushbutton	134.39
<b>SELECTOR SWITCH ASSEMBLED</b>		
10250T20KBP0P	2-Position Maintained Black Selector Switch	90.98
10250T21KBP0P	3-Position Maintained Black HOA Selector Switch	102.88
<b>INDICATING LIGHTS ASSEMBLIES</b>		
10250T206NC1NP0P	24 Volt Red, Green & Amber Lenses	137.87
10250T34RP0P	120 Volt Red, Green & Amber Lenses	164.40
<b>ILLUMINATED PUSHBUTTON ASSEMBLIES</b>		
10250T476C211P0P	24V Red Pushbutton, Green & Amber Lenses	176.95
10250T411C211P0P	120V Red Pushbutton, Green & Yellow Lenses	197.89

Contact Blocks and Legend Plates Included Where Required

**OIL-TIGHT PUSHBUTTON OPERATORS**

Vendor Code: **CHC**

Catalog Number	Button Color	Price Each
<b>FLUSH BUTTON</b>		
10250T101	Black	39.17
10250T102	Red	39.17
10250T103	Green	39.17
<b>EXTENDED BUTTON</b>		
10250T111	Black	39.17
10250T112	Red	39.17
<b>MUSHROOM HEAD</b>		
10250T121	Black	95.30
10250T122	Red	90.79
10250T123	Green	95.30
<b>JUMBO MUSHROOM HEAD</b>		
10250T172	Red	111.94

**OIL-TIGHT STANDARD INDICATING LIGHTS**

Vendor Code: **CHC**

Catalog Number	Volts	Price Each
<b>TRANSFORMER TYPE</b>		
10250T181L	120	138.85
10250T181N	120	139.42
10250T182N	240	144.59
10250T184N	480	144.59

**OIL-TIGHT SELECTOR SWITCHES**

Vendor Code: **CHC**

Catalog Number	Cam Code	Price Each
<b>2-POSITION MAINTAINED</b>		
10250T1311	1	54.45
<b>3-POSITION MAINTAINED</b>		
10250T1322	2	61.30
10250T1323	3	54.45

See Selector Switch Cam and Contact Block Selection on Right.

**CONTACT BLOCKS**

Vendor Code: **CHC**

Catalog Number	Circuits	Price Each
<b>PRESSURE TERMINALS</b>		
10250T51C	1 NC	21.80
10250T53C	1NO	21.28
10250T1C	1 NO - 1 NC	34.05
10250T2C	2 NO	43.26
10250T3C	2 NC	41.72

**LENS**

Vendor Code: **CHC**

Catalog Number	Color	Price Each
<b>STANDARD PLASTIC LENS</b>		
10250TC1N	Red	10.09
10250TC2N	Green	10.67



**SELECTOR SWITCH CAM CODE AND CONTACT BLOCK SELECTION**

Circuit of Contact Block 10250	CAM Code #1	CAM Code #2	CAM Code #3
<b>Knob Position</b>	↖ ↗	↖ ↗	↖ ↗
<b>NORMAL - T1</b>			
NC A	0	X	X
NO B	0	X	0
<b>INVERTED - T1</b>			
NO A	X	0	0
NC B	X	0	X
<b>T2 (TYPICAL HAND-OFF-AUTO CIRCUIT)</b>			
NO A	X	0	0
NO B	0	X	0
<b>T3</b>			
NC A	0	X	X
NC B	X	0	X

O = Open Contacts, X = Closed Contacts, Shown With Two Circuit Contact Blocks.  
 "Circuit A" = Top Contact; "Circuit B" = Bottom Contact

**KNOCKOUT PUNCH**

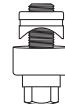

Vendor Code: **GRE**

Catalog Number	Size	Price Each
<b>KNOCKOUT FOR 30.5MM (1-7/32")</b>		
10807	Slugbuster	98.99

Includes: Punch, Die and Draw Stud.



## NEMA STANDARD DUTY PUSHBUTTON STATIONS

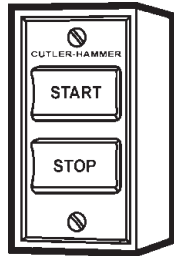

Vendor Code: **CHC**

Catalog Number	Standard Legend	Price Each
<b>TWO PUSHBUTTONS - NEMA 1</b>		
<b>10250H5200</b>	Start - Stop	148.41
<b>TWO PUSHBUTTONS - NEMA 3R</b>		
<b>10250H671</b>	Star - Stop	540.82
<b>THREE PUSHBUTTONS - NEMA 1</b>		
<b>10250H5300</b>	Forward - Reverse - Stop	353.83

## OIL-TIGHT ENCLOSURES FOR FULL SIZE OPERATORS NEMA TYPE 4, 4X, 12 & 13

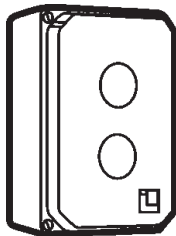

Vendor Code: **CHC**

Catalog Number	Number of Elements	Price Each
<b>TWO - CONTACT BLOCK DEPTH</b>		
<b>10250TN11</b>	1	124.40
<b>10250TN12</b>	2	147.11
<b>10250TN13</b>	3	173.05



## STANDARD LEGEND PLATES FOR PUSHBUTTON AND INDICATING LIGHTS



- The legend plates listed below are sized for all standard commercial enclosures and Eaton's cast enclosures.
- Letters on legend plates below are 3/16" high.

Vendor Code: **CHC**

Catalog Number	Label	Price Each
<b>10250TM12</b>	Down	5.41
<b>10250TM13*</b>	Emergency Stop	5.41
<b>10250TM15</b>	Forward	5.41
<b>10250TM24*</b>	Off	5.41
<b>10250TM25</b>	On	5.41
<b>10250TM29</b>	Reset	5.41
<b>10250TM30</b>	Reverse	5.41
<b>10250TM33</b>	Start	5.46
<b>10250TM34*</b>	Stop	5.46

\*Red Field, All Others Have Black Field

## LEGEND PLATES FOR SELECTOR SWITCH



- Lettering on 2-position legend plates are 5/32" high.
- Lettering on 3-position legend plates are 1/8" high.

Vendor Code: **CHC**

Catalog Number	Label	Positions	Price Each
<b>10250TM36</b>	Blank	n/a	5.83
<b>10250TM37*</b>	Blank	n/a	5.77
<b>10250TM42</b>	Off/On	2	5.83
<b>10250TM47</b>	Start/Stop	2	5.77
<b>10250TM49</b>	Auto/Off/Hand	3	5.77
<b>10250TM51</b>	Hand/Off/Automatic	3	5.83
<b>10250TM54</b>	Up/Off/Down	3	5.77
<b>10250TM67</b>	Manual/Automatic	2	5.77
<b>10250TM68</b>	Manual/Off/Automatic	3	5.77

\*Red Field, All Others Have Black Field



22.5 MM Industrial Pushbuttons

Eaton's M22 industrial heavy duty pushbutton line offers a wide array of functional, attractive and ergonomically designed illuminated and non-illuminated pushbuttons, selector-switches, push-pulls, alternate action and twist-to release operators.

- Modular construction makes assembly fast and simplifies stocking of components and complete devices
- Field convertibility of operator status for pushbuttons and selector switches helps customers reduce inventory and increase functionality
- LED offering only for improved brightness quality and up to 100,000 hours of operation
- Plastic construction is corrosion resistant. Operators are designed for rugged environments, ideal for washdown applications. Rated NEMA 4X/13 on front of panel operators.
- Anti-rotation tab saves installation time and prevents operator rotation
- High mechanical and electrical life allows for use in tough and challenging applications
- Laser inscription capabilities allow for high quality, wear-resistant markings
- All normally closed (NC) contacts are Direct Opening Action, i.e., NC contacts are physically forced open by direct linkage with the pushbutton operator in the unlikely event of contact weld
- Most pushbutton operators and contact blocks exceed 5 million mechanical operations
- Contact blocks rated for 10A 600V
- Can fit in 1/2" knockout

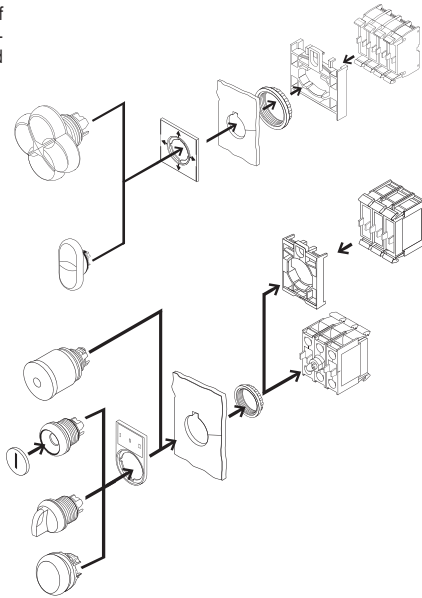

Motor Control

H

PUSHBUTTON & INDICATING LIGHT ASSEMBLIES

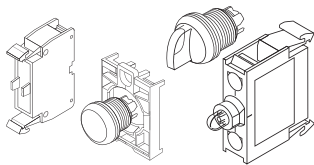

- Includes necessary operator, contactor blocks and mount

Vendor Code: **CHC**

Catalog Number	Description	Contact Blocks	Price Each
<b>NON-ILLUMINATED PUSHBUTTON, MOMENTARY*</b>			
M22DSK11P	Black Flush	1NO-1NC	36.87
M22DHRK11P	Red Extended	1NO-1NC	38.41
<b>ILL. LED PUSHBUTTON 85-246V, MOMENTARY*</b>			
M22DLHRK11230RP	Red Extended	1NO-1NC	76.38
M22PVLK12230RP	Red Push-Pull E-Stop	1NO-2NC	102.59
<b>LED INDICATING LIGHTS 85-264V</b>			
M22LR230RP	Red	-	49.61
M22LG230GP	Green	-	49.61
<b>SELECTOR SWITCHES, MAINTAINED**</b>			
M22WKVK11P	2-Pos. Maint.	1NO-1NC	52.78
M22WK3K22P	3-Pos. Maint.	2NO-2NC	75.78

\*Field-Convertible (Maintained to Momentary) Pushbuttons are Available.  
 \*\*Selector Switches are Field Convertible from Momentary to Maintained by Adjusting Coding Adapter(s) Listed on Page H13.

NON-ILLUMINATED PUSHBUTTON OPERATORS MAINTAINED/MOMENTARY

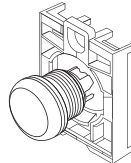

Vendor Code: **CHC**

Catalog Number	Description	Price Each
<b>BLANK OPERATORS WITH BUTTON COVERS*</b>		
M22DRXSRG**	Flush with Black/Red/Green	10.38
M22DRHXSRG**	Extended with Black/Red/Green	12.52
<b>BUTTON COVERS***</b>		
M22XDSWRGYB	Flush Button Covers*	5.49
<b>MUSHROOM HEAD*</b>		
M22DRPS**	Black	35.39
M22DRPR**	Red	35.39
M22DRPG**	Green	35.39
<b>E-STOP OPERATOR*</b>		
M22PV	Red, Pull-to-Release	17.67

\*Includes Contact Block Mounting Adapter; Contact Blocks Required.  
 \*\*Field Convertible to Momentary by Switch on Threaded Barrel.  
 \*\*\*Includes Black, White, Red, Green, Yellow, Blue Button Covers.

ILLUMINATED PUSHBUTTON OPERATORS MAINTAINED/MOMENTARY

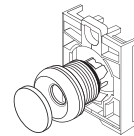

Vendor Code: **CHC**

Catalog Number	Description	Price Each
<b>FLUSH PUSHBUTTON OPERATOR</b>		
M22DRLW	White	19.56
M22DRLG	Green	20.00
<b>EXTENDED PUSHBUTTON OPERATOR</b>		
M22DRLHR	Red	20.03
M22DRLHG	Green	20.03

Field Convertible to Momentary by Switch on Threaded Barrel.  
 Includes Contact Block Mounting Adapter; LED Light Unit and Contact Blocks Required.





## SELECTOR SWITCHES MOMENTARY/MAINTAINED

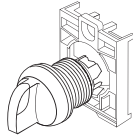

Vendor Code: **CHC**

Catalog Number	Description	Price Each
<b>SELECTOR SWITCHES*</b>		
<b>M22WK**</b>	2-Position	15.27
<b>M22WK3**</b>	3-Position	14.71
<b>PLUNGER BRIDGE</b>		
<b>M22XW</b>	Required to Operate Center-Mounted Contact Block on 3-Position Selector Switches	3.69

Contact Blocks Required.  
\*\*Selector Switches are Field Convertible from Momentary to Maintained by Adjusting Coding Adapter(s) Listed Below.

## SELECTOR SWITCHES CODING ADAPTER GUIDE

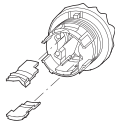

Switch Position Left	Adapter Insert Position		Switch Position Right
	Bottom	Top	
<b>TWO POSITION SELECTOR SWITCH</b>			
(NA)			Momentary
	-	-	Maintained
<b>THREE POSITION SELECTOR SWITCH</b>			
Momentary			Momentary
Maintained	-	-	Maintained
Maintained	-		Momentary
Momentary		-	Maintained



## INDICATING LIGHTS

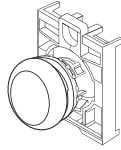

Vendor Code: **CHC**

Catalog Number	Lens Color	Price Each
<b>M22LR</b>	Red	7.11
<b>M22LG</b>	Green	7.11
<b>M22LY</b>	Yellow*	7.16

LED Light Unit Required.  
\*Use White LED Light Unit for Yellow Lens.

## LED LIGHT UNITS FOR ILLUMINATED PUSHBUTTONS AND INDICATOR LIGHTS

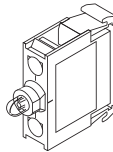

Vendor Code: **CHC**

Catalog Number	LED Color	Price Each
<b>12-30V AC/DC</b>		
<b>M22LEDR</b>	Red	17.87
<b>M22LEDG</b>	Green	17.87
<b>M22LEDW</b>	White	17.87

Catalog Number	LED Color	Price Each
<b>85-264V AC/DC</b>		
<b>M22LED230R</b>	Red	17.87
<b>M22LED230G</b>	Green	17.87
<b>M22LED230W</b>	White	17.87

## CONTACT BLOCKS

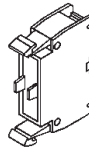

Vendor Code: **CHC**

Catalog Number	Description	Price Each
<b>SCREW TERMINAL CONTACT BLOCKS</b>		
<b>M22K10</b>	1 Normally Open	5.38
<b>M22K01</b>	1 Normally Closed	5.38
<b>SPRING CAGE TERMINAL*</b>		
<b>M22CK10</b>	1 Normally Open	7.98
<b>M22CK01</b>	1 Normally Closed	7.98
<b>M22CK01D</b>	1 Normally Closed Late-Break	12.75
<b>M22CK20</b>	2 Normally Open	16.03
<b>M22CK02</b>	2 Normally Closed	16.03

\*Spring Cage Terminals Can Accommodate Two Wires Up to #12 AWG.

## LEGEND PLATES



Vendor Code: **CHC**

Catalog Number	Description	Price Each
<b>FOR PUSHBUTTONS AND PILOT LIGHTS</b>		
<b>M22SSTGB1</b>	Start	3.35
<b>M22SSTGB0</b>	Stop	3.35
<b>M22SSTGB7</b>	Run	3.35
<b>FOR SELECTOR SWITCHES</b>		
<b>M22SSTGB10</b>	Off/On	4.29
<b>M22SSTGB12</b>	Hand/Off/Automatic	3.35

## OIL-TIGHT ENCLOSURES FOR 22MM OPERATORS NEMA 4X, 13

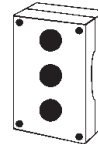

Vendor Code: **CHC**

Catalog Number	Description	Price Each
<b>ONE PUSHBUTTON</b>		
<b>M2211PG</b>	1 Pushbutton Enclosure	50.54
<b>M2212PG</b>	2 Pushbutton Enclosures	54.55
<b>M2213PG</b>	3 Pushbutton Enclosures	62.33

Motor Control

H

**OPERATORS FOR ROTARY HEAD SWITCHES (ROLLER LEVERS)**

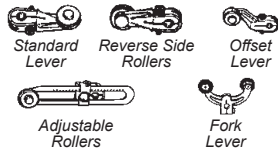

Vendor Code: **CHC**

Catalog Number	Length	Width	Type	Price Each
<b>STANDARD ROLLER LEVERS</b>				
<b>E50KL200</b>	1-1/2"	5/16"	Nylon	20.78
<b>E50KL355</b>	1-1/2"	5/16"	Metal	20.78
<b>E50KL377</b>	1-1/2"	1"	Nylon	34.10
<b>E50KL531</b>	1-1/2"	1/4"	Bear.	85.19
<b>ADJUSTABLE ROLLERS</b>				
<b>E50KL201</b>	1 - 3-3/4"	5/16"	Nylon	28.44
<b>E50KL537</b>	1 - 3-3/4"	3/4"	Nylon	50.93
<b>REVERSE SIDE ROLLERS</b>				
<b>E50KL310</b>	1-1/2"	5/16"	Nylon	20.67
<b>E50KL536</b>	1-1/2"	9/32"	Nylon	33.98
<b>OFFSET LEVER</b>				
<b>E50KL27</b>	1-1/2"	5/16"	Outboard	20.67
<b>FORK LEVER - ROLLERS ON SAME SIDE</b>				
<b>E50KL204</b>	1-1/2"	5/16"	Nylon	33.98
<b>FORK LEVER - ROLLERS ON OPPOSITE SIDE</b>				
<b>E50KL203</b>	1-1/2"	5/16"	Nylon	30.87

**ROD OPERATORS**

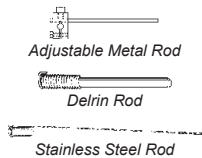

Vendor Code: **CHC**

Catalog Number	Length	Price Each
<b>1/8" ADJUSTABLE METAL ROD</b>		
<b>E50KL202</b>	5-1/2" Max	35.82
<b>1/4" DELRIN ROD</b>		
<b>E50KW2</b>	3-3/8"	21.79
<b>1/16" STAINLESS STEEL ROD</b>		
<b>E50KW3</b>	12"	13.59

**OPERATING HEADS**

Vendor Code: **CHC**

Catalog Number	Description	Price Each
<b>E50DR1</b>	Spring Return	90.02
<b>E50DL1</b>	Spring Return	122.67
<b>E50DM1</b>	Two Position, Maintained	141.55
<b>E50DS1</b>	Push Spring Return	133.68
<b>E50DS2</b>	Push Spring Return	151.05
<b>E50DS3</b>	Push Spring Return	153.90
<b>E50DH1</b>	Push*	163.40
<b>E50DT1</b>	Push Spring Return	112.10
<b>E50DT2</b>	Push Spring Return	130.04
<b>E50DT3</b>	Push Spring Return	147.37
<b>E50DW1</b>	Wobble Spring Return	107.09

**OPERATING HEADS**

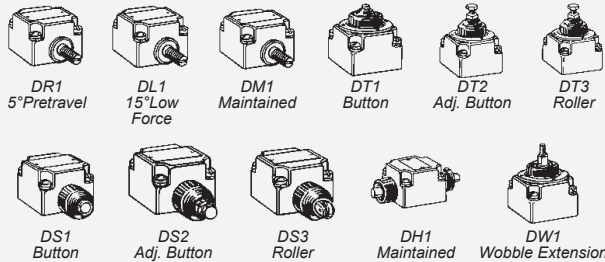

**SWITCH BODIES**

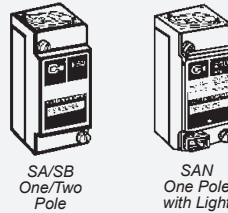

**RECEPTACLES**

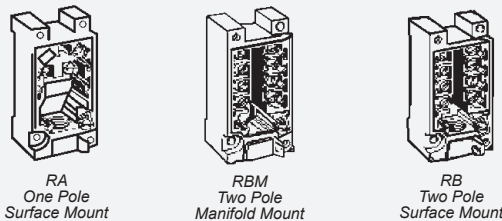

**SWITCH BODIES**

Vendor Code: **CHC**

Catalog Number	Description	Price Each
<b>E50SA</b>	Standard 1NO - 1NC	93.62
<b>E50SAN</b>	1NO - 1NC w/Light	152.95
<b>E50SB</b>	Standard 2NO - 2NC	131.02

**RECEPTACLES FOR PLUG-IN SWITCH**

Vendor Code: **CHC**

Catalog Number	Description	Price Each
<b>E50RA</b>	5 Terminal	26.09
<b>E50RB</b>	9 Terminal	36.94







### ELC PROGRAMMABLE LOGIC CONTROLLERS

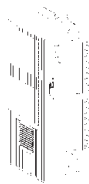

Controller



Module

As master or slave, ELC controllers can create an unlimited hierarchy of communications.

**Capability** - ELC controllers provide the instruction set of a large PLC in a small package. It is capable of 1-, 4-, 8-, 16-, and 32-bit instructions, block compare, block move, communications, interrupts, clock/calendar and over 240 logic instructions.

**Flexibility** - Expandable from 10 I/O to 256 I/O per controller.

**Size** - Most modules are only 1" wide and offer I/O from 4 In and 4 Out, to 8 In and 8 Out.

**Remote Communications** - ELC analog modules are capable of stand-alone operation. Mounted remotely, the ELC communicates to the analog module through its communications port. The ELC also lets you read parameters, set parameters, use scale, offset, and average values.

#### Choose From

- Analog In/Out
- Standard Thermocouple
- Platinum Thermocouple
- RTD

#### Complete Assembly Includes

- Controller
- Expansion Modules
- Power Supply

#### High-Level Network Access Through These Eaton Gateways

- Modbus TCP
- DeviceNet
- Profibus

#### Convenient Use and Installation

- DIN Rail Mounted
- Built-In Display

Vendor Code: **CHC**

Catalog Number	Description	Power Required	Price Each
<b>CONTROLLERS</b>			
<b>ELC2PB14NNDR</b>	8 DC In / 6 Relay Out	150 mA	280.62
<b>ELC2PC12NNDR</b>	8 DC In / 4 Relay Out, Clock	150 mA	358.15
<b>ELC2PV28NNDR</b>	16 DC In / 12 Relay Out	220 mA	658.46
<b>EXPANSION MODULES</b>			
<b>ELCEX16NNDR</b>	8 DC In / 8 Relay Out	90 mA	201.85
<b>ELCEX08NNNR</b>	8 Relay Out	70 mA	161.10
<b>ELCEX08NNDN</b>	8 DC In	50 mA	102.77
<b>ELCEX08NNAN</b>	8 AC In	50 mA	121.85
<b>ELCAN04ANNN</b>	4 Analog In	90 mA	326.15
<b>ELCAN06AANN</b>	4 Analog In/2 Analog Out	90 mA	496.00
<b>ELCEX06NNNI</b>	6 Relay (6 Amp) Out	70 mA	179.69
<b>ACCESSORIES</b>			
<b>ELCPS01</b>	24VDC Power Supply	1,000 mA	87.43
<b>ELCPS02</b>	24VDC Power Supply	2,000 mA	126.85
<b>ELCCBPCELC3</b>	9.8ft (3m) PC Cable	-	53.43

If 24V DC is Not Available, Select Power Supply from Above. Programming Software is Available for Free at [Eaton.com](http://Eaton.com).



### EZ SERIES INTELLIGENT RELAYS

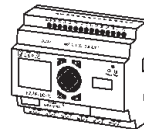

EZ Relays are an easy to use programmable relay that provide users with timing relays, flash relays, counters, comparators, timer switches, and other ready-to-use functions. Available in 32 different styles supporting 10 I/O to 320 I/O, EZ Relays are perfect for replacing an aging electro-mechanical control panel or controlling a new production line - anywhere relays, timers, and pushbuttons are used.

- User friendly operation
- Ready to use function blocks
- Built in timing relays, flash relays, counters, comparators, timer switches and other ready-to-use functions
- Integrated power flow display to ensure safe operation
- Circuit diagram stored internally or can be output on a memory module
- 100 to 240V AC
- 8A relay output

Vendor Code: **CHC**

Catalog Number	Description	Price Each
<b>EZ RELAYS</b>		
<b>EASY512ACRC</b>	8 AC In / 4 Relay Out, Clock, Display	195.93
<b>EASY719ACRC</b>	12 AC In / 6 Relay Out, Clock, Display	274.24
<b>EZ ACCESSORIES</b>		
<b>EASYPCCAB</b>	EZ-500/700 PC to EZ Cable	126.40

Programming Software Free at [Eaton.com](http://Eaton.com)

### HMI OPERATOR INTERFACE

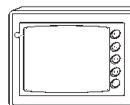

HMI simplifies configuring application parameters with features and software that provide added capabilities and make monitoring your system intuitive.

- HMI stores entire application, including images, so editing won't require original source files.
- Flexibility, plus the security of password protection, makes HMI the perfect operator interface for any user.
- Picture Bank uploads/downloads images to a personal computer.
- Easy-to-use macro ability, from simple math, storing and manipulating trends, data, and communications, to sending data from one PLC to another.

Vendor Code: **CHC**

Catalog Number	Description	Price Each
<b>HMI INTERFACES</b>		
<b>HMIVU04CUNBE</b>	4" Color Touchscreen with On-Board Ethernet	630.58
<b>HMIVU07CUNBE</b>	7" Color Touchscreen with On-Board Ethernet	1065.66
<b>HMIVU08CUNBE</b>	8" Color Touchscreen with On-Board Ethernet	1674.20
<b>HMI ACCESSORIES</b>		
<b>HMISPKIT</b>	HMI Spare Parts Kit	36.81

Programming Software is Available for Free at [Eaton.com](http://Eaton.com).

Motor Control

H

BASIC SENSOR OPERATIONS

INDUCTIVE PROXIMITY SENSORS

Inductive proximity sensors will sense all metals. The exact point at which a target will be detected is influenced by the type of metal, its size and surface area. The following charts show the sensing fields for a standard target: 45mm sq., mild steel, 1mm thick.

STANDARD RANGE

Shielded - Can be mounted flush with metal surface.

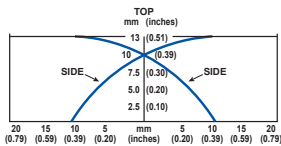

EXTENDED RANGE

Non-Shielded - Can not be mounted flush with metal surface.

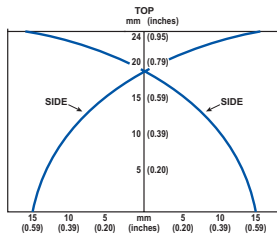

The two most common approach directions are axial (head-on) and lateral (from the side). Detection occurs at the point where the target first touches the envelope of the sensing curve. The curve shown is for a standard target and must be corrected for other size targets.

TARGET CORRECTION FACTORS

(Multiply sensing range of device by factor given below)

Target	Sensor Size (in millimeters)			
	4 - 8	12	18	30
400 Stainless	0.90	0.90	1.00	1.00
300 Stainless	0.65	0.70	0.70	0.85
Brass	0.35	0.45	0.45	0.45
Aluminum	0.35	0.40	0.40	0.40
Copper	0.30	0.25	0.35	0.30

USEFUL CONVERSIONS

Inches to Millimeters: Inches / 0.03937  
 Millimeters to Inches: Millimeters X 0.03937

PHOTO-ELECTRIC SENSORS

DIFFUSE-REFLECTIVE

This type of sensor detects the reflection of transmitted light from the surface of an object. Shortest sensing range of all photoelectrics.

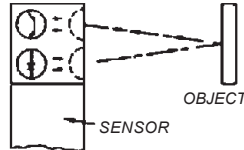

RETRO-REFLECTIVE

This type of sensor utilizes a special reflector to return the beam directed at it from the sensor. An object between the sensor and reflector is sensed when it interrupts the beam. Medium sensing range.

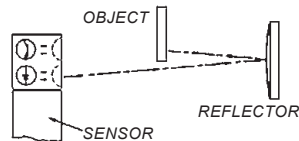

THRU-BEAM

Separate emitter and receiver provide maximum detection range and most positive type of sensing for opaque objects. When an object interrupts the beam from emitter to receiver, the object is detected.

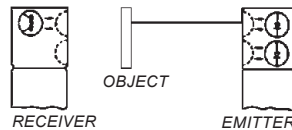



## Inductive Proximity Sensors

### INDUCTIVE PROXIMITY SENSORS

#### TUBULAR

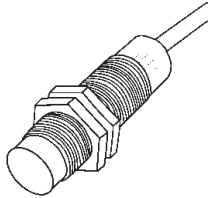

- Stainless steel barrel manufactured to take physical and environmental abuse
- 360° output status indicator visible from any angle in any light
- Protected against industrial transients and exceed NEMA 1500V showering arc specifications
- Extended range models offer over 3 times the range of standard models

Vendor Code: **CHC**

Catalog Number	Thread Size	Sense. Dist.	Price Each
<b>20–250V AC, STANDARD RANGE*</b>			
<a href="#">E57LAL12A2</a>	12mm	2mm	158.34
<a href="#">E57LAL18A2</a>	18mm	5mm	185.93
<a href="#">E57LAL30A2</a>	30mm	10mm	189.32
<b>35–250V AC, EXTENDED RANGE*</b>			
<a href="#">E57LAL12A2E</a>	12mm	4mm	189.26
<a href="#">E57LAL18A2E</a>	18mm	8mm	187.67
<a href="#">E57LAL30A2E</a>	30mm	15mm	166.05
<b>20–250V AC, N.C.</b>			
<a href="#">E57LBL12A2EA</a>	12mm	4mm	171.39
<b>20–250V AC, N.O.*</b>			
<a href="#">E57LAL12A2EA</a>	12mm	4mm	171.39
<a href="#">E57LAL18A2EA</a>	18mm	8mm	171.72
<a href="#">E57LAL30A2EA</a>	30mm	15mm	195.72
<b>10–50V DC, SHIELDED N.O.</b>			
<a href="#">E57LAL12T111</a>	12mm	4mm	115.02
<a href="#">E57LAL12T111SD</a>	12mm	2mm	142.06

\*Listed AC Units Have Normally Open Outputs. Replace Fifth Character (in Black) of Catalog Number with: **B** for **Normally Closed Outputs**.

#### LONG RANGE, HEAVY DUTY

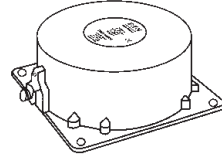

- Robust design and longest sensing ranges available (up to 100mm)
- Small diameter, 2-wire AC/DC models feature a selector switch inside the housing, enables output contacts to be used as either N.O. or N.C.
- Auto-configure output technology on 4-wire DC models automatically detects how sensor has been wired (NPN or PNP) and switches sensor without user intervention
- Includes additional power and output LEDs to make troubleshooting easier

Vendor Code: **CHC**

Catalog Number	Sensing Distance	Price Each
<b>20–250V AC / 20–60V DC, N.O. OR N.C. UNSHIELDED</b>		
<a href="#">E56CDL50A2E</a>	50mm	345.87

Motor Control

H

**A SENSOR FOR ANY APPLICATION!  
CONTACT YOUR LOCAL  
ELLIOTT ELECTRIC SUPPLY  
FOR MORE INFORMATION!**





Photoelectric Sensors

**COMET 100 SERIES  
HIGH PERFORMANCE  
PHOTOELECTRIC SENSORS**

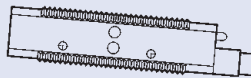

- Available in AC/DC versions as well as DC only
- Rated to NEMA Types 1, 2, 3, 4, 4X, 6, 6P, 12 & 13
- 3/4" (18mm) tubular or flat surface mounting
- 8 ms response time on AC/DC versions; 1 ms on DC only versions
- Short circuit protection standard on AC/DC version

**THRU BEAM  
20 – 264V AC OR 15 – 30V DC**

Vendor Code: **CHC**

Catalog Number	Description	Range	Price Each
<b>WIDE ANGLE</b>			
<b>11100A6513</b>	Emitter	25 Feet	86.67
<b>12100A6513</b>	Receiver	25 Feet	132.03
<b>NARROW ANGLE, RIGHT ANGLE VIEW</b>			
<b>11100R6513</b>	Emitter	20 Feet	86.67
<b>12100R6513</b>	Receiver	20 Feet	132.03

Emitter and Receiver Required for Complete Installation.

**RETRO REFLECTIVE\*  
20 – 264V AC OR 15 – 30V DC**

Vendor Code: **CHC**

Catalog Number	Voltage	Range	Price Each
<b>VISIBLE BEAM</b>			
<b>14102A6513</b>	AC or DC	25 Feet	203.20
<b>POLARIZED VISIBLE BEAM</b>			
<b>14101A6513</b>	AC or DC	15 Feet	165.24

\*Requires Reflector for Complete Installation See Below.

**PERFECT PITCH DIFFUSE REFLECTIVE  
20 – 264V AC OR 15 – 30V DC**

- Uses two separate optical detectors with sharp optical cutoff to detect objects at maximum range while avoiding detection of background objects
- High excess gain reliably detects low reflectance targets
- Convertible between light detection and dark detection on some models
- Short circuit protection on all models

Vendor Code: **CHC**

Catalog Number	Voltage	Range	Price Each
<b>13104A6513</b>	AC or DC	2.25 Inches	188.30
<b>13103A6513</b>	AC or DC	9 Inches	188.30

**E58 SERIES  
HARSH DUTY PHOTOELECTRIC SENSORS**

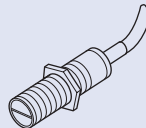

- 30mm, threaded 303 stainless steel housing
- 6P+ construction guaranteed not to fail from moisture ingress for 5 years
- Glass lens standard
- Brightest output indicator available, flashes under short circuit protect mode
- SJO cable standard with industry standard quick connectors available
- Food Processing Options: 316 stainless steel housing; smooth body plastic lens

**THRU BEAM  
20 – 132V AC**

Vendor Code: **CHC**

Catalog Number	Description	Price Each
<b>E5830TS250GA</b>	800' Emitter Dark Sense	311.85
<b>E5830TD250GD</b>	800' Receiver Dark Sense	338.82

**REFLECTORS  
SENSOR ACCESSORIES**

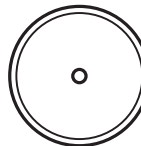

Vendor Code: **CHC**

Catalog Number	Description	Price Each
<b>6200A6501</b>	3" Diameter with Mounting Hole, Two per Package	24.67





## MINI-BEAM SENSORS

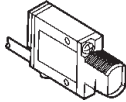

Vendor Code: **BAN**

Catalog Number	Range	Supply Voltage	Cbl. Len.	Price Each
<b>EMITTER, OPPOSED MODE</b>				
SM31E	10'	10-30V DC	6.5'	69.01
SMA31EL	100'	24-240V AC	6.5'	84.00
<b>RECEIVER, OPPOSED MODE</b>				
SM31R	10'	10-30V DC	6.5'	98.00
SM2A31R	10'	24-240V AC	6.5'	121.02
SM2A31RL	100'	24-240V AC	6.5'	121.00
<b>DIFFUSE MODE</b>				
SM312DQD	15"	10-30V DC	6.5"	139.20
SM2A312D	15"	24-240V AC	6.5"	140.00
SM2A312DQD	15"	24-240V AC	6.5"	140.00
<b>DIVERGENT DIFFUSE MODE (CLEAR MAT.)</b>				
SM312W	5"	10-30V DC	6.5"	116.02
<b>RETROREFLECTIVE MODE</b>				
SM312LV	15"	10-30V DC	6.5"	116.02
SM312LVQD	15"	10-30V DC	6.5"	139.20
SM2A312LVAG	2" - 7"	24-240V AC	6.5"	146.03
<b>CONVERGENT MODE, VISIBLE RED</b>				
SM312CVQD	0.65"	10-30V DC	6.5"	124.02

\*Includes Quick Disconnect Cable.  
\*\*Polarized

## SM30 SERIES 30MM BARREL SENSORS (OPPOSED MODE)

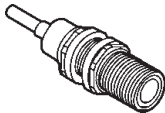

Vendor Code: **BAN**

Catalog Number	Description	Price Each
<b>PLASTIC HOUSING, A FREQUENCY*</b>		
SMA30PEL	AC/DC Emitter	157.85
SM2A30PRL	AC Receiver	204.04
SM30PRL	DC Receiver	185.05
<b>STAINLESS STEEL, A FREQUENCY*</b>		
SMA30SEL	AC/DC Emitter	228.00
SM2A30SRL	AC Receiver	262.06
SMA30SELQD	AC/DC Emitter**	228.00
SM2A30SRLQD	A/C Receiver**	262.22
SM2A30SRLNCQD	A/C Receiver** Dark Operate	262.22
SM30SRLQD	DC Receiver**	237.76
<b>STAINLESS HOUSING, B FREQUENCY</b>		
SMA30SELQDB	Emitter**	231.53
SM2A30SRLQDB	Receiver**	332.40

\*For Alternate Frequencies:  
Add **B** for **B Frequency** or **C** for **C Frequency** to the End of the Part Number. Call for Pricing.  
\*\*Includes Quick Disconnect Cable.

## MAXI-BEAM MODULAR SENSORS

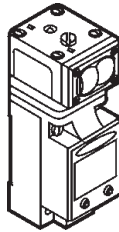

- Programming and sensing response
- Alignment indicating device
- Components bolt together quickly and easily

## SENSOR HEADS

Vendor Code: **BAN**

Catalog Number	Range	Description	Price Each
<b>OPPOSED MODE</b>			
RSBE	300'	Emitter	129.00
RSBR	300'	Receiver	164.00
<b>RETROFLECTIVE MODE</b>			
RSBLV	6" - 30'	Non-Polar.	174.00
RSBLVAG	1' - 15'	Polarized	201.54
<b>DIFFUSE MODE</b>			
RSBD	5'	Long Range	174.00
RSBDSR	30"	Short Range	174.00

NOTE: Banner Products are only available in select Elliott Electric Supply locations. To check which locations stock Banner products, visit [www.ElliottElectric.com](http://www.ElliottElectric.com)

## POWER BLOCKS

Vendor Code: **BAN**

Catalog Number	Description	Price Each
<b>BASE</b>		
RWB4	Wiring Base*	33.00
<b>DC POWER BLOCKS</b>		
RPBT	In: 10 - 30V DC Out: 250 mA	100.00
<b>AC POWER BLOCKS, 2-WIRE</b>		
RPBA	In: 105 - 130V AC Out: Max.: 250V AC / 750 mA	121.00
RPBA1	For RSBE Emitter	96.00

\*Wiring Base Required for All Maxi-Beam Assemblies.

## ACCESSORIES

Vendor Code: **BAN**

Catalog Number	Description	Price Each
<b>RETROREFLECTIVE TARGETS</b>		
BRT3	3.3" Round	7.00
BRTTHG2100	2" x 100" Tape	54.88
<b>QUICK DISCONNECT CABLES</b>		
MBCC312	12' 3-Pin	51.19
SM30CC312	12' 3-Pin*	49.92
MBCC512	12' 5-Pin	47.00
MBCC530	30' 5-Pin	74.00
<b>MINI-BEAM BRACKETS</b>		
SMB18A	SS Rt. Angle	6.00
<b>SM30 BRACKET</b>		
SMB30A	SS Rt. Angle	8.00

\*Use with 2-Wire SM30.

Motor Control

H



**POWER SUPPLIES  
PSG SERIES**



PSG60E (Single Phase)

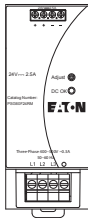

PSG60F24RMA1 (Three Phase)

- General-purpose 12 Vdc and 24 Vdc output for 1.25A to 40A loads
- Single-phase and three-phase inputs up to 500 Vac
- 150% power surge output
- Redundancy modules
- Buffer module
- DIN rail mount
- Rugged metal and plastic housing options
- Heavy-duty screw and finger-safe terminals
- Hazardous Location Class I, Division 2 rated models
- NEC® Class II rated model
- Protection from overvoltage, overcurrent and overtemperature conditions

Vendor Code: **CHC**

Catalog Number	Output Current	Dimensions			Price Each
		L	W	H	
<b>85-264VAC 1 PHASE INPUT / 24VDC OUTPUT</b>					
PSG60E	2.5A	4.76"	1.25"	4.75"	94.73
PSG120E	5A	4.76"	1.26"	4.72"	215.23
PSG240E	10A	4.76"	3.35"	4.67"	303.56
PSG480E	20A	4.76"	6.3"	4.53"	393.84
<b>320-575VAC 3 PHASE INPUT / 24VDC OUTPUT</b>					
PSG60F24RM	2.5A	4.76"	1.97"	4.62"	124.26
PSG120F24RM	5A	4.76"	1.97"	4.62"	339.51
PSG240F24RM	10A	4.76"	2.76"	4.62"	347.20
PSG480F24RM	20A	4.76"	5.51"	4.62"	395.60



**TIMING RELAYS**

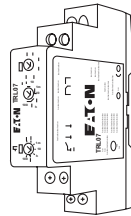

DIN Rail Mount

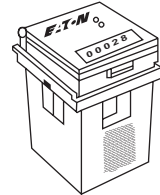

Socket Mount

Function	Description
1	Asymmetrical flasher, pause first
2	Asymmetrical flasher, pulse first
3	ON delay and OFF delay with control contact
4	ON delay and single shot leading edge voltage controlled
5	ON delay and single shot leading edge control contact
6	Single shot leading and single shot trailing edge with control contact
7	Pulse sequence monitoring
8	ON delay, power triggered
9	Single shot leading edge voltage controlled
10	OFF delay/signal OFF delay
11	Single shot leading edge with control input
12	Single shot trailing edge with control input
13	ON delay control signal start, trailing edge OFF
14	Flasher, pause first
15	Retriggerable single shot
16	Flasher, ON first
17	ON delay control signal start, leading edge OFF
18	Flasher—control signal start, pause first
19	Flasher—control signal start, ON first
20	Signal ON/OFF delay
21	ON/OFF delay
22	Single pulse generator
23	Memory latch
24	True OFF Delay

Vendor Code: **CHC**

Catalog Number	Functions	Price Each
<b>8A AC OUTPUT, 24-240V AC/DC</b>		
TRL04*	8, 9, 10, 14	43.73
TRL07*	8, 9, 10, 11, 12, 13, 14	48.49
<b>8A AC OUTPUT, 12/240V AC/DC</b>		
TRL27**	8, 9, 10, 11, 12, 13, 14	62.55
<b>12A AC 8-PIN OCTAL BASE, 12-240V AC/DC</b>		
TMRP5102**	8, 9, 10, 11, 14, 15, 16, 21, 22, 23	254.25
<b>12A AC 11-PIN BASE, 12-240V AC/DC</b>		
TMRP5100**	8, 9, 10, 11, 14, 15, 16, 21, 22, 23	253.71
<b>ACCESSORIES</b>		
D3PA2	8-PIN Round, Screw Terminal Socket	13.82
D3PA3	11-PIN Round, Screw Terminal Socket	17.62

\*Single Pole, Double Throw  
\*\*Double Pole, Double Throw



## 3-Phase Voltage Monitors · Relays (Alternating · Operate Delay)

### 3 PHASE VOLTAGE MONITORS SOCKET MOUNT

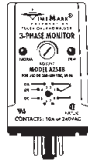

Monitors 3-phase power lines for abnormal conditions. When properly adjusted, the unit will detect phase loss on a loaded motor even when regenerated voltage is present. Both the 257 & 258 models do not require a neutral connection and can be used in either Wye or Delta configurations.

- 10A SPDT output contacts
- Monitors and detects phase loss, low voltage and phase reversal
- Automatic restart
- Wide range adjustment
- 5 year unconditional warranty

Vendor Code: **TIM**

Catalog Number	A/C Input Voltage	Adjustment Range	Relay Base	Price Each
<b>TOP CONTROL</b>				
<b>257B</b>	208/240V	160-240V	8-Pin Octal	83.54
<b>A257B</b>	480V	380-480V	8-Pin Octal	83.54
<b>SIDE CONTROL</b>				
<b>258B</b>	208/240V	160-240V	8-Pin Octal	83.54
<b>A258B</b>	480V	380-480V	8-Pin Octal	76.87

Other Voltages Available

### 3 PHASE VOLTAGE MONITORS PANEL MOUNT

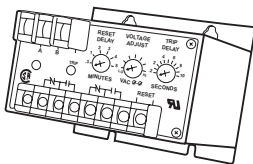

C2652

These 3 phase voltage monitors offer the same capabilities as the 257 and 258 models as well as offer additional contacts and timing functions not found in socket mount models.

**C2652** - Detects low voltage, phase loss, phase reversal. DPDT output relay. Adjustable trip relay up to 10 seconds. Adjustable restart relay up to five minutes to prevent short cycling.

**C269** - Detects high voltage, low voltage, phase loss and phase reversal. Adjustable trip relay up to 10 seconds. SPDT output relay.

Vendor Code: **TIM**

Catalog Number	A/C Input Voltage	Adjustment Range	Relay Base	Price Each
<b>C2652</b>	480V	380-500V	DPDT	222.43
<b>C269</b>	480V	380-540V	SPDT	199.87

Other Voltages Available

### ALTERNATING RELAYS



Model 261 alternating relays are designed for duplex pumping systems where equalized pump run times are desired. The relay requires continuous power source and control switch. Relay output contacts change states when control switch opens. Toggle switch is set to NORMAL position. Toggle to Load 1 or Load 2 to lock relay in position and prevent alternation.

- 10A contacts
- 90-130V operating voltage range
- Toggle switch to prevent alternation and lock relay on Load 1 or Load 2
- UL, CSA recognized

Vendor Code: **TIM**

Catalog Number	Input Voltage	Contact Configuration	Relay Base	Price Each
<b>261ST120V</b>	120VAC/DC	SPST	8-Pin Octal	93.93
<b>261DT120V</b>	120VAC/DC	DPDT	11-Pin Round	112.36

Other Voltages Available

### OPERATE DELAY RELAYS

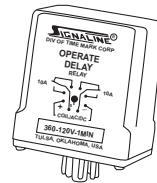

360120V1MIN

The Model 360 Operate Delay Relays are designed for a wide range of industrial applications. Examples include automatic and machine tool control circuits. HVAC circuits, and warm-up delay circuits. The Model 360 is SPDT, high accuracy digital timer. Solid state timing circuits in each model drive an internal electromechanical relay.

Vendor Code: **TIM**

Catalog Number	A/C Input Voltage	Timing Range	Relay Base	Price Each
<b>360120V1MIN</b>	120V	1-1023 Minutes	8-Pin Octal	85.09

Other Voltages Available



**TIME MARK**  
CORPORATION



General Purpose Plug-In Relays · Latching Relays · Relay Mounting Sockets

GENERAL PURPOSE PLUG-IN RELAYS



Vendor Code: **CHC**

Catalog Number	Contact Configuration	Coil Voltage	Relay Base	Price Each
<b>20A AC 5-BLADE</b>				
D1RR1B	SPDT	240V	D1PAA	11.39
<b>10A AC 8-BLADE</b>				
D2RR2T	DPDT	24V	D2PAL	7.91
D2RR2A	DPDT	120V	D2PAL	7.91
D2RR2B	DPDT	240V	D2PAL	13.78
<b>10A DC 8-BLADE</b>				
D2RR2T1	DPDT	12V	D2PAL	19.68
D2RR2R1	DPDT	24V	D2PAL	38.87
<b>10A AC 11-BLADE SQUARE BASE</b>				
D2RR4B	4PDT	120V	D2PA6	13.19

LATCHING RELAYS



Vendor Code: **CHC**

Catalog Number	Contact Configuration	Coil Voltage	Relay Base	Price Each
<b>5A DC 14-PIN</b>				
D2PR5T1	DPDT	24V	D2PA6	77.05
<b>5A AC 14-PIN</b>				
D2PR5T	DPDT	24V	D2PA6	33.78
D2PR5A	DPDT	110V	D2PA6	64.09

RELAY MOUNTING SOCKETS

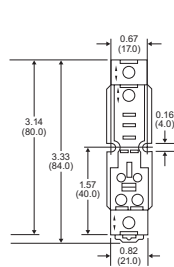

D1RAA

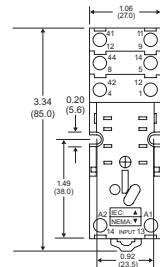

D2PAL

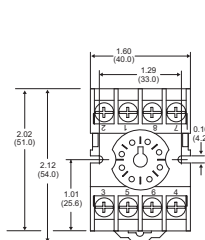

D3PA2

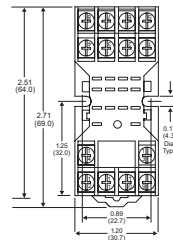

D2PA6

Vendor Code: **CHC**

Catalog Number	Description	Price Each
D1RAA	20A 5-Blade Screw Terminal Socket	5.71
D2PA6	10A 14-Blade Screw Terminal Socket	20.45
D2PAL	10A 8-Blade Screw Terminal Socket	16.44
D3PA2	16A 8-Pin Octal Screw Terminal Socket	13.82

Motor Control

H







## STANDARD OCTAL BASES

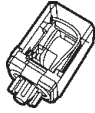

Vendor Code: **IDC**

Catalog Number	Contact Configuration	Coil Voltage	Relay Base	Price Each
<b>10A AC 8 PIN ROUND BASE</b>				
RR2PUAC24V	DPDT	24V	SR2P06	20.87
RR2PUAC120V	DPDT	120V	SR2P06	20.87
RR2PUAC240V	DPDT	240V	SR2P06	18.06
RR2PULAC24V*	DPDT	24V	SR2P06	22.87
RR2PULAC120V*	DPDT	120V	SR2P06	22.87
<b>10A DC 8-PIN ROUND BASE</b>				
RR2PUDC12V	DPDT	12V	SR2P06	19.87
RR2PUDC24V	DPDT	24V	SR2P06	19.87
<b>10A AC 11-PIN ROUND BASE</b>				
RR3PAUAC120V	3PDT	120V	SR3P06	23.97

\*Includes LED Indicator.

## MAGNETIC LATCHING RELAYS



RR2KPUAC Series

Vendor Code: **IDC**

Catalog Number	Contact Configuration	Coil Voltage	Relay Base	Price Each
<b>10A 11-PIN OCTAL BASE PERMANENT MAGNET, DUAL COIL LATCHING RELAY</b>				
RR2KPUAC24V	DPDT	24V	SR2P06	66.22
RR2KPUAC120V	DPDT	120V	SR2P06	63.62



## COMPACT BLADE BASES

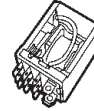

Vendor Code: **IDC**

Catalog Number	Contact Configuration	Coil Voltage	Relay Base	Price Each
<b>10A AC 5-BLADE</b>				
RH1BUAC24V	SPDT	24V	SH1B05	10.87
RH1BUAC120V	SPDT	120V	SH1B05	10.87
<b>10A DC 8-BLADE</b>				
RH2BUDC24V	DPDT	24V	SH2B05	9.87
<b>10A AC 8-BLADE</b>				
RH2BUAC24V	DPDT	24V	SH2B05	10.97
RH2BUAC110120V	DPDT	120V	SH2B05	10.97
<b>10A AC 11-BLADE</b>				
RH3BUAC120V	3PDT	120V	SH3B05	13.87
<b>10A AC 14-BLADE</b>				
RH4BUAC120V	4PDT	120V	SH4B05	16.87

## RH SERIES DIN RAIL SNAP MOUNT SOCKETS



5 Blade  
SH1B05

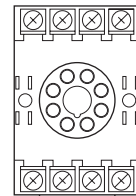

8 Pin  
SR2B06

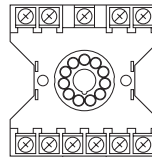

11 Pin  
SR3P06

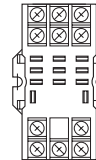

11 Blade  
SH3B05

Vendor Code: **IDC**

Catalog Number	Description	Price Each
SH1B05	5 Blade SPDT	5.87
SH2B05	8 Blade DPDT	6.99
SH3B05	11 Blade 3PDT	7.87
SH4B05	14 Blade 4PDT	9.87
SR2P06	8 Pin Round, Screw Terminal DPDT	5.99
SR3P06	11 Pin Round, Screw Terminal 3PDT	8.87

Motor Control

H

**DIN RAIL MOUNT CIRCUIT BREAKERS**

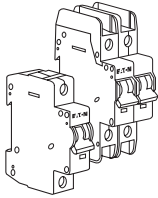

**UL 489 or UL 1077?**

While both devices may be mounted on 35mm DIN rail and may look the same, not all miniature circuit breakers carry equal ratings. Only UL 489 devices carry the necessary rating to be used as branch protection. UL 1077 devices are only rated for use as supplemental protection and may only be used in conjunction with a branch rated device. Think of it this way: a UL 489 device carries the same rating and offers the same protection as a typical thermal-magnetic circuit breaker. A UL 1077 device is what you would use to provide over-current protection to a PLC, control power transformer, or lighting circuit in a controlpanel once you run power to it from a UL 489 branch device.

**UL 489 Miniature Circuit Breakers:**

- UL489 and CSA C22.2 certified
- Suitable for branch circuit protection and motor control
- Switching duty rated - suitable for switching fluorescent loads
- Width is 17.7mm per pole
- Rated for 10kaic @ 277/480Vac

Vendor Code: **CHC**

Catalog Number	Amperage	Trip Curve*	Price Each
<b>UL 489 1 POLE**</b>			
<b>FAZC51NASP</b>	5	C	48.33
<b>FAZC101NASP</b>	10	C	48.51
<b>FAZC151NASP</b>	15	C	48.51
<b>FAZC201NASP</b>	20	C	48.51
<b>FAZC301NASP</b>	30	C	48.33

\*B & D Curve Versions are Available

\*\*Two and Three Pole Versions are Available

**UL 1077 Supplemental Circuit Protectors**

- UL 1077, CSA CS22.2 No.235, and IEC 60947-2 certified
- Offers supplemental protections for control circuits, lighting, business equipment, and appliances
- Current limiting design
- Width is 17.5mm per pole
- Rated for 10kaic @ 277/480Vac

Vendor Code: **CHC**

Catalog Number	Amperage	Trip Curve*	Price Each
<b>UL 1077 1 POLE**</b>			
<b>FAZC51SP</b>	5	C	27.28
<b>FAZC101SP</b>	10	C	27.58
<b>FAZC151SP</b>	15	C	27.58
<b>FAZC201SP</b>	20	C	27.58
<b>FAZC301SP</b>	30	C	27.58

\*B & D Curve Versions are Available

\*\*Two and Three Pole Versions are Available

**WEIDMULLER TERMINAL BLOCKS**

Electrical & Electronic Connection Systems

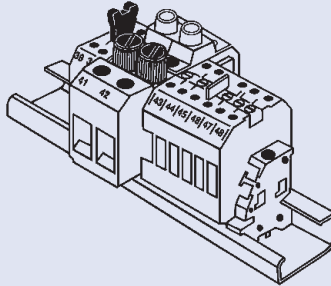

- Vibration resistant clamping action
- Efficient use of expensive space
- Fast, easy installation
- Terminal blocks for many functions
- Trouble free operation with added safety
- Corrosion resistant clamping action

**Weidmüller**

**UNIVERSAL RAIL MOUNT SAK-EN TERMINAL BLOCKS**

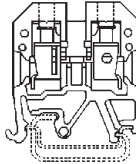

Vendor Code: **WEI**

Catalog Number	Description	Price Each
<b>20 AMP, 600V, 22-12</b>		
<b>1061200000</b>	End Bracket (TS35)	2.33
<b>0206160000</b>	End Bracket (TS32)	1.31
<b>0218660000</b>	Terminal Block	1.59
<b>30 AMP, 600V, 22-10</b>		
<b>1061200000</b>	End Bracket (TS35)	2.33
<b>0206160000</b>	End Bracket (TS32)	1.31
<b>1020180000</b>	Terminal Block	1.19

**FUSED TERMINAL BLOCKS W SERIES FEED-THROUGH (FITS TS35X7.5 RAIL ONLY)**

Vendor Code: **WEI**

Catalog Number	Description	Price Each
<b>16 AMP, 600V, 20-8</b>		
<b>1014000000</b>	Without LED Indicator*	8.70
<b>1014300000</b>	40 – 60V DC / 80 – 120V AC**	15.13

\*Uses 1/4" x 1-1/4" Fuse.

\*\*Includes Blown Fuse Indicator, Uses 1/4" x 1-1/4" Fuse.

**NOTE:** Custom labelling is available from Elliott Electric Supply Houston locations.

**DIN RAIL**

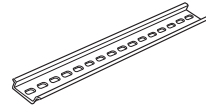

Vendor Code: **WEI**

Catalog Number	Description	Price Each
<b>TYPE TS35 X 7.5</b>		
<b>0383400000</b>	Solid Steel Rail	17.81
<b>0514500000</b>	Slotted Steel Rail	19.87
<b>TYPE TS32</b>		
<b>5144000000</b>	Slotted Steel Rail	19.29

**TERMINAL BLOCKS W SERIES (FITS TS35X7.5 RAIL ONLY)**

- Slim design - 60 Terminal Blocks per foot
- High-Temperature ratings: Can withstand operating temperatures of 250°F continuous / 350°F to 24 hours

Vendor Code: **WEI**

Catalog Number	Description	Price Each
<b>20 AMP, 600V, 22-12</b>		
<b>1020000000</b>	Terminal Block	1.27
<b>1010000000</b>	Ground Terminal	5.76
<b>1061200000</b>	End Bracket	2.33
<b>1050000000</b>	End Cover Bracket	0.92
<b>45 AMP, 600V, 20-8</b>		
<b>1020200000</b>	Terminal Block	2.02
<b>1010200000</b>	Ground Terminal	6.47
<b>1061200000</b>	End Bracket	2.33
<b>1050000000</b>	End Cover Plate	0.92

Call for a **FREE Terminal Block Engineering Guide** or a complete **Product Selection Catalog**. Weidmüller also offers layout software. Contact your Elliott Electric Supply salesperson for more information.



TERMINAL BLOCKS

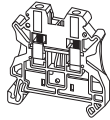

XBUT4

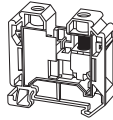

XBUT35

Vendor Code: **CHC**

Catalog Number	Amps	Voltage	Width	Wire Size	Color	Price Each
<b>FEED THROUGH SCREW CLAMPS</b>						
<b>XBUT25</b>	20	600	5.2mm	26-12AWG	Gray	0.91
<b>XBUT4</b>	30	600	6.2mm	26-10AWG	Gray	1.10
<b>XBUT6</b>	50	600	8.2mm	24-8AWG	Gray	1.39
<b>XBUT10</b>	65	600	10.2mm	20-6AWG	Gray	1.74
<b>XBUT16</b>	85	600	12mm	16-4AWG	Gray	3.28
<b>XBUT35</b>	150	600	16mm	14-1/0AWG	Gray	4.82

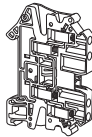

XBUT25D22



XBUTT4

Vendor Code: **CHC**

Catalog Number	Conductors	Amps	Voltage	Width	Wire Size	Price Each
<b>MULTI CONDUCTOR SCREW CLAMPS</b>						
<b>XBUT25D22</b>	4	20	150	5.2mm	26-12AWG	2.58
<b>DOUBLE LEVEL SCREW CLAMPS</b>						
<b>XBUTT4</b>	4	30	300	5.2mm	26-12AWG	2.93

\*Products above are Gray, please add the following color codes to specify other colors

**BK** – Black, **BU** – Blue, **GN** – Green, **OR** – Orange, **RD** – Red, **WH** – White, **YE** – Yellow  
 \*Not All Colors Available for All Amperages. Check with Your Elliott Salesperson for Availability on Specific Items.

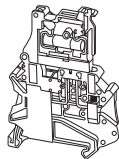

Vendor Code: **CHC**

Catalog Number	Voltage	Fuse	Width	Wire Size	Price Each
<b>FUSIBLE SCREW CLAMPS</b>					
<b>XBUT4FBE</b>	600	5 x 20mm	6.2mm	26-10AWG	5.00

Black Color  
 \*With Blown Fuse Indicator



SCREW CLAMP GROUND BLOCKS

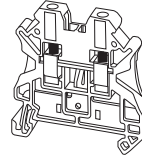

Vendor Code: **CHC**

Catalog Number	Width	Wire Size	Color	Price Each
<b>XBUT25PE</b>	5.2mm	26-12 AWG	Green/Yellow	3.54
<b>XBUT4PE</b>	6.2mm	26-10 AWG	Green/Yellow	3.95

DIN RAIL

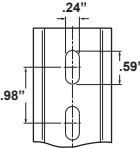
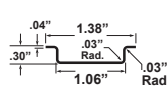

XBANS3575P

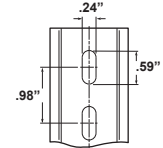
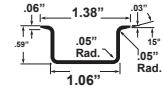

XBANS3515P

Vendor Code: **CHC**

Catalog Number	Description	Price Each
<b>XBANS3575P</b>	Slotted, 35mm x 7.5mm x 2 Meters Long	19.59
<b>XBANS3515P</b>	Slotted, 35mm x 15mm x 2 Meters Long	38.20

TERMINAL BLOCK ACCESSORIES

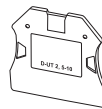

XBACUT10



XBAES35C

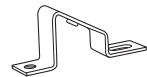

XBANBGSH

Vendor Code: **CHC**

Catalog Number	Description	Price Each
<b>XBACUT10</b>	End Cover for the XBUT25, 4, 6 & 10 Terminal Blocks	0.43
<b>XBACUT16</b>	End Cover for the XBUT16 Terminal Blocks	0.71
<b>XBACUT4D12</b>	End Cover for the XBUT25D12 & XBUT4D12	0.95
<b>XBACUT4D22</b>	End Cover for the XBUT25D22 & XBUT4D22	0.76
<b>XBAFBS25</b>	2 Pole Plug-in Bridge for XBUT25 Terminal Blocks	0.41
<b>XBAFBS55</b>	5 Pole Plug-in Bridge for XBUT25 Terminal Blocks	1.74
<b>XBAFBS105</b>	10 Pole Plug-in Bridge for XBUT25 Terminal Blocks	3.26
<b>XBAFBS26</b>	2 Pole Plug-in Bridge for XBUT4 Terminal Blocks	0.41
<b>XBAFBS56</b>	5 Pole Plug-in Bridge for XBUT4 Terminal Blocks	1.67
<b>XBAFBS106</b>	10 Pole Plug-in Bridge for XBUT4 Terminal Blocks	3.26
<b>XBAES35C</b>	35mm Universal End Stop	1.11
<b>XBANBGS</b>	35.4mm 30 Degree Angle Mounting Bracket	5.17
<b>XBANBGSH</b>	46mm 30 Degree Angle Mounting Bracket	11.95

Motor Control

H

**FIRE ALARM STATIONS**

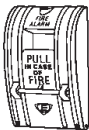

Vendor Code: **EDW**

Catalog Number	Switch Type	Pole	Voltage	Price Each
<b>270SP0</b>	Normally Open	Single	125 / 250	37.98

**TRANSFORMERS**

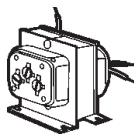

Vendor Code: **EDW**

Catalog Number	Description	Price Each
<b>596</b>	120 – 6/12/18V AC, 15 VA	20.61
<b>592</b>	120 – 8/16/24V AC, 20 VA	22.60
<b>598</b>	120 – 8/16/24V AC, 30 VA	26.06
<b>599</b>	120 – 24V AC, 40 VA	26.30

**DOOR SWITCHES**



Vendor Code: **EDW**

Catalog Number	Description	Price Each
<b>236</b>	Door Trip Switch	25.77

**PUSHBUTTONS**

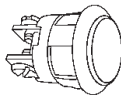

Vendor Code: **EDW**

Catalog Number	Description	Price Each
<b>620</b>	Low Voltage, 5/8" Diameter, Chrome Finish	5.69

**BEACON LIGHTS**



Vendor Code: **EDW**

Catalog Number	Color	Voltage	Price Each
<b>52AN540WH</b>	Amber	120	238.05
<b>52RN540WH</b>	Red	120	238.05

**BELLS**



720



340 Series

Vendor Code: **EDW**

Catalog Number	Description	Price Each
<b>720</b>	6", 3 – 6V DC, Dixie Bell	20.27
<b>ADAPTABLE, AC VIBRATING</b>		
<b>3404G5</b>	4", 24V AC, Bell	121.76
<b>3404N5</b>	4", 120V AC, Bell	116.28
<b>3406N5</b>	6", 120V AC, Bell	138.23

**BUZZERS**



725 or 740



340AG5 or 340AN5

Vendor Code: **EDW**

Catalog Number	Description	Price Each
<b>725</b>	6 – 8V AC, Dixie Buzzer	14.91
<b>740</b>	6 – 8V DC, Nubel	17.35
<b>340AG5</b>	24V AC, Buzzer	130.55
<b>340AN5</b>	120V AC, Buzzer	130.55

**HORNS**



Vendor Code: **EDW**

Catalog Number	Description	Price Each
<b>123AN5</b>	120V AC, Midi Horn	20.27
<b>874N5</b>	120V AC, Grille Type	104.24
<b>876N5</b>	120V AC, Weatherproof	139.32

Motor Control

H





Harsh Locations

SECTION



# Harsh Locations



## Harsh Locations

### Conduit Outlet Bodies

Conduit Outlet Bodies.....	14
GUA Junction Boxes.....	14
Capped Elbows.....	15
Control Station Device Bodies.....	15
Seal-Offs.....	15
Chico®.....	15

### Pin & Sleeve Devices

Appleton Devices.....	16
Eaton Devices.....	16
Killark Devices.....	16

### LED

High Bays.....	17
Floods.....	17
Light Poles.....	17
Low Bays.....	17

### Cast Device Boxes







Cast Device Boxes.....	18
Non-Hazardous Location Drains.....	18
Ark-Gard® Plugs and Receptacles.....	18

### Cable Glands

Armored.....	19
Non-Armored.....	19

### Enclosures

Clamped.....	110
Lighting and Heat Tracing Panelboards.....	110

Classes	Divisions	Groups
<p><b>CLASS I</b> GAS</p> 	<p><b>DIV 1</b> NORMAL</p> 	<p><b>A, B, C, D</b></p> 
<p><b>CLASS II</b> DUST</p> 	<p><b>DIV 2</b> ABNORMAL</p> 	<p><b>E, F, G</b></p> 
<p><b>CLASS III</b> FIBERS</p> 		

### DEFINITIONS

**HAZARDOUS LOCATION [Nec 500]** - An area where the possibility of explosion and fire is created by the presence of flammable gases, vapors, dusts, fibers or flyings.

**CLASS I [NEC-500.5(b)]** - Those areas in which flammable gases or vapors are or may be present in the air in quantities sufficient to produce explosive or ignitable mixtures.

**CLASS II [NEC-500.5(c)]** - Those areas made hazardous by the presence of combustible dust.

**CLASS III [NEC-500.5(d)]** - Those areas that are hazardous because of the presence of easily ignitable fibers or flyings, but in which such fibers or flyings are not likely to be in suspension in the air in quantities sufficient to produce ignitable mixtures.

**DIVISION 1 [NEC-500.5(b)(1), 500.5(c)(1), 500.5(d)(1)]** - Division One in the normal situation, the hazard would be expected to be present in everyday production operations or during frequent repair and maintenance activity.

**DIVISION 2 [NEC-500.5(b)(2), 500.5(c)(2), 500.5(d)(2)]** - Division Two in the abnormal situation, material is expected to be confined within closed containers or closed systems and will be present only through accidental rupture, breakage, or unusual faulty operation.

**GROUPS [NEC-500.6(a)(1,2,3,4) & 500.6(b) (1,2,3)]** - The gases of vapors of Class I locations are broken into four groups by the code, A, B, C, and D. These materials are grouped according to the ignition temperature of the substance, its explosion pressure and other flammable characteristics.

Class II - dust locations - groups E, F, and G. These groups are classified according to the ignition temperature and the conductivity of the hazardous substance.

**SEALS (NEC-501.15 & 502.15)** - Special fittings that are required either to prevent the passage of hot gasses in the case of an explosion in a Class I area of the passage of combustible dust, fibers, or flyings in a Class II or III area.

**ARTICLES 500 Through 504 (2005 NEC)** - Explains in detail the requirements for the installation of wiring of electrical equipment in hazardous locations. These articles along with other applicable regulations, local governing inspection authorities, insurance representatives, and qualified engineering/technical assistance should be your guides to the installation of wiring or electrical equipment in any hazardous or potentially hazardous location.

### TYPICAL CLASS I LOCATIONS:

- Petroleum refineries, and gasoline storage and dispensing areas.
- Industrial firms that use flammable liquids in dip tanks for parts cleaning or other operations.
- Petrochemical companies that manufacture chemicals from gas and oil.
- Dry cleaning plants where vapors from cleaning fluids can be present.
- Companies that have spraying areas where they coat products with paint or plastics.
- Aircraft hangars and fuel servicing areas.
- Utility gas plants, and operations involving storage and handling of liquefied petroleum gas or natural gas.

### TYPICAL CLASS II LOCATIONS:

- Grain elevators, flour and feed mills.
- Plants that manufacture, use, or store magnesium or aluminum powders.
- Plants that have chemical or metallurgical processes of plastics, medicines and fireworks, etc.
- Producers of starch or candies.
- Spice-grinding plants, sugar plants and cocoa plants.
- Coal preparation plants and other carbon-handling or processing areas.

### TYPICAL CLASS III LOCATIONS:

- Textile mills, cotton gins, cotton seed mills, and flax processing plants.
- Any plant that shapes, pulverizes, or cuts wood and creates sawdust or flyings.

Note: Fibers and flyings are not likely to be suspended in the air, but can collect around machinery or on lighting fixtures and where heat, a spark, or hot metal can ignite them.



**CONDUIT OUTLET BODIES**  
 CLASS I, GROUPS C & D  
 CLASS II, GROUPS E, F & G  
 CLASS III

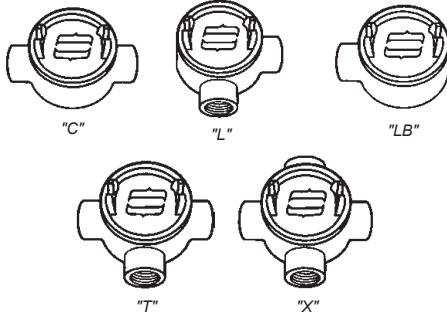

Vendor Code: **CRS**

Catalog Number	Conduit Size	Style Size	Cubic in. (in <sup>3</sup> )	Price Each
<b>3" COVER OPENING</b>				
GUAC16	1/2"	C	13.3	82.38
GUAL16	1/2"	L	13.3	82.38
GUAB16	1/2"	LB	13.3	82.38
GUAT16	1/2"	T	13.3	87.23
GUAX16	1/2"	X	13.3	91.12
GUAC26	3/4"	C	13.5	90.90
GUAL26	3/4"	L	13.5	87.23
GUAB26	3/4"	LB	13.5	87.23
GUAT26	3/4"	T	13.5	92.69
GUAX26	3/4"	X	13.5	97.53
GUAC36	1"	C	15.5	91.12
GUAL36	1"	L	15.5	91.12
GUAB36	1"	LB	15.5	91.12
GUAT36	1"	T	15.5	99.92
GUAX36	1"	X	15.5	106.83
<b>5" COVER OPENING</b>				
GUAC49	1-1/4"	C	76.0	416.66
GUAL49	1-1/4"	L	80.0	449.94
GUAT49	1-1/4"	T	76.0	439.88
GUAX49	1-1/4"	X	80.0	454.88
GUAC59	1-1/2"	C	77.8	488.58
GUAL59	1-1/2"	L	77.8	294.62
GUAB59	1-1/2"	LB	76.0	294.62
GUAT59	1-1/2"	T	77.8	323.32
GUAX59	1-1/2"	X	77.8	333.86
GUAC69	2"	C	80.0	454.88
GUAL69	2"	L	80.0	302.54
GUAB69	2"	LB	80.0	312.89
GUAT69	2"	T	80.0	333.87
GUAX69	2"	X	80.0	512.00



**GUA JUNCTION BOXES**  
 WITH UNION HUBS



Vendor Code: **CRS**

Catalog Number	Description	Cubic in. (in <sup>3</sup> )	Price Each
GUAG7775	3/4" Hubs	22.8	289.31
GUAG8885	1" Hubs	22.8	324.00
GUAH7775	3/4" Hubs	23.5	513.60

Class I Groups C & D. Class II Groups E, F, & G. Class III.

**FLEXIBLE COUPLINGS**



Vendor Code: **CRS**

Catalog Number	Size	Price Each
ECLK112	1/2" X 12"	318.43
ECLK118	1/2" X 18"	355.56
ECLK212	3/4" X 12"	372.93
ECLK218	3/4" X 18"	454.68

Class I groups A, B, C, & D. Class II groups E, F, & G. Class III. Other Sizes and Lengths Available. See Store for Details.

**UNIONS**  
 CLASS I, GROUPS C & D  
 CLASS II, GROUPS E, F, & G  
 CLASS III

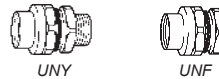

Vendor Code: **CRS**

Catalog Number	Description	Carton Quantity	Price Each
<b>FEMALE/FEMALE HUB</b>			
UNF105*	1/2" Steel	10	18.95
UNF205*	3/4" Steel	10	26.14
UNF305*	1" Steel	5	47.18
UNF405	1-1/4" Feraloy	5	71.01
UNF505	1-1/2" Feraloy	5	91.18
UNF605	2" Feraloy	2	117.23
UNF705	2-1/2" Feraloy	1	175.94
UNF805	3" Feraloy	1	241.84
UNF905**	3-1/2" Feraloy	1	535.48
UNF1005**	4" Feraloy	1	596.92
<b>MALE/FEMALE HUB</b>			
UNY105*	1/2" Steel	10	20.58
UNY205*	3/4" Steel	10	29.38
UNY305*	1" Steel	5	49.94
UNY405	1-1/4" Feraloy	5	76.47
UNY505	1-1/2" Feraloy	2	99.27
UNY605	2" Feraloy	2	127.27
UNY705	2-1/2" Feraloy	1	206.76
UNY805	3" Feraloy	1	280.73
UNY905**	3-1/2" Feraloy	1	453.91
UNY1005**	4" Feraloy	1	496.42

\*Suitable for Class I Groups A, B, C, and D  
 \*\*Suitable for Class I, Groups B, C, and D

Harsh Locations





## Capped Elbows · Control Station Device Bodies and Covers · Thread Lubricants

### CAPPED ELBOWS TYPE "LBY"



Vendor Code: **CRS**

Catalog Number	Description	Carton Quantity	Price Each
<b>LB15</b>	1/2" Feraloy	10	29.90
<b>LB25</b>	3/4" Feraloy	5	35.85
<b>LB35</b>	1" Feraloy	5	39.20

Class 1 groups C and D. Class II groups E, F, and G. Class III.

### CONTROL STATION DEVICE BODIES AND COVERS CLASS I, GROUPS C & D CLASS II, GROUPS E, F & G CLASS III

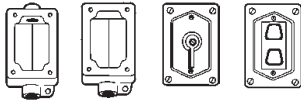

Vendor Code: **CRS**

Catalog Number	Description	Price Each
<b>CONTROL STATION DEVICE BODIES**</b>		
<b>EDS271</b>	3/4" Dead End	81.24
<b>EDSC271</b>	3/4" Feed Through	86.73
<b>EDS371</b>	1" Dead End Single Gang	84.15
<b>EDSC371</b>	1" Feed Through Single Gang	93.72
<b>EDS272</b>	3/4" Dead End Double Gang	157.22
<b>EDSC272</b>	3/4" Feed Thr. Double Gang	163.20
<b>EDS372</b>	1" Dead End Double Gang	229.06
<b>EDSC372</b>	1" Feed Thr. Double Gang	241.92
<b>COVER &amp; DEVICE SUB-ASSEMBLIES</b>		
<b>DD918</b>	Single PB 1NO / 1NC	296.10
<b>DD922</b>	Start/Stop 2NO / 2NC	342.56
<b>DD918S769EMSP</b>	1 Circuit Emrg Stop Pushbutton	596.27
<b>DD923</b>	2 Circuit 2 Position Selector Switch	291.61
<b>DD925</b>	2 Circuit 3 Position Selector Switch	295.81
<b>DD933</b>	20A 120/277V 1-Pole Toggle	174.14
<b>DD917</b>	30 Amp 3 Pole Snap Switch	537.38
<b>COMPLETE ASSEMBLIES (BODY, COVER, &amp; DEVICE)</b>		
<b>EDS21273</b>	3/4" Dead End w/ 3 Position 2 Circuit Selector Switch	378.36
<b>EDSC21273</b>	3/4" Feed Through w/ 3 Position 2 Circuit Selector Switch	389.53
<b>EDS21275</b>	3/4" Dead End w/ 3 Position 4 Circuit Selector Switch	571.65
<b>EDSC21275</b>	3/4" Feed Through w/ 3 Position 4 Circuit Selector Switch	578.50
<b>EDS2129</b>	3/4" Dead End w/ 1P 20A Snap Switch	408.67
<b>EDSC2129</b>	3/4" Feed Thr. w/ 1P 20A Snap Switch	429.59

\*Emergency Stop Legend Included  
\*\*Suitable for Group B Div 2



### THREAD LUBRICANTS

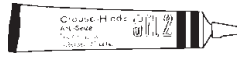

Vendor Code: **CRS**

Catalog Number	Description	Price Each
<b>STL2</b>	1.75 oz. Tube	25.85
<b>STL8</b>	8 oz. Can	54.35

### SEAL-OFF



Vertical



Horizontal / Vertical

Vendor Code: **CRS**

Catalog Number	Conduit Size	Cubic in. Vert/Horiz	Ctn. Qty.	Price Each
<b>VERTICAL POSITION ONLY</b>				
<b>EYS16</b>	1/2"	1 / 0	5	29.39
<b>EYS26</b>	3/4"	2 / 0	5	35.78
<b>EYS36</b>	1"	3.75 / 0	2	46.74
<b>VERTICAL OR HORIZONTAL POSITION</b>				
<b>EYS116</b>	1/2"	1 / 1	5	29.39
<b>EYS216</b>	3/4"	2 / 2	5	42.39
<b>EYS316</b>	1"	3 / 3.5	2	43.37
<b>EYS46*</b>	1-1/4"	6 / 8	2	56.64
<b>EYS56*</b>	1-1/2"	10.75 / 12.25	2	83.28
<b>EYS66*</b>	2"	19 / 22.75	1	108.46
<b>EYS76*</b>	2-1/2"	25.5 / 30	1	172.74
<b>EYS86*</b>	3"	56 / 64.5	1	213.31
<b>EYS96*</b>	3-1/2"	72 / 82	1	667.42
<b>EYS106*</b>	4"	95 / 110	1	828.38

Class I, Groups A, B, C and D Class II, Groups E, F and G  
All Above are Male/Female Hubs. Remove Nipple for Female/Female.

\*These Catalog Numbers Are Only Rated for Class I Groups C&D, Class II Groups F&G, and Class III.

### "UNIVERSAL" DRAIN OR BREATHER



Vendor Code: **CRS**

Catalog Number	Description	Carton Quantity	Price Each
<b>ED15</b>	1/2" Male Thread	15	65.20

Class I, Groups B, C and D, Class II, Groups E, F and G, Class III

### CHICO® SEALING COMPOUNDS



Vendor Code: **CRS**

Catalog Number	Description	Price Each
<b>SEALING COMPOUND</b>		
<b>CHIC0A3</b>	1 lb. / 23 Cubic in.	22.90
<b>CHIC0A05</b>	5 lbs. / 115 Cubic in.	73.25
<b>X FIBER</b>		
<b>CHIC0X4</b>	3 oz. Fiber	28.91
<b>CHIC0X7</b>	1 lb. Fiber	165.53

### CHICO® SPEEDSEAL™ COMPOUND



- Installs a reliable seal in five minutes - every time
- Hardens to a dense, strong mass that is suitable for Class I, Division 1, Groups C, D and Class II, Division 1, Groups E, F, G hazardous applications
- UL and cUL Listed for use with 1/2" to 2" Eaton's Crouse-Hinds series sealing fittings only
- Packaged in a 2 oz. or 6 oz. pre-measured cartridge, eliminating the need for measuring before mixing
- Packaged with a screw-on nozzle for accurate dispensing
- Expands in the sealing fitting, eliminating the need to separate the individual conductors with Chico X fiber
- Chico X fiber dams are not required in horizontal applications, reducing installation times
- Completely hardens in 20 minutes, simplifying use for OEMs
- Suitable for cold temperature environments without the costly need to build a temporary shelter around sealing fittings; all ice crystals must be removed from inside the conduit seal before dispensing Chico SpeedSeal compound; the Chico SpeedSeal compound should be kept above 10°C (50°F) and below 85°F (29°C) prior to mixing; the sealing fitting must be kept at or above 4°C (40°F) during the 4 to 10 minute expansion/gel time of the compound
- 18 month shelf life

Vendor Code: **CRS**

Catalog Number	Description	Price Each
<b>CHICO SPEEDSEAL</b>		
<b>CHIC0SS2</b>	2 oz. Compound	45.16
<b>CHIC0SS6</b>	6 oz. Compound	92.34

Harsh Locations



## Pin and Sleeve Devices (Receptacles · Plugs · Mounting Boxes)

Appleton, Killark, and Crouse-Hinds are UL1686 approved for interoperability. May not be suitable for all applications. Brand and availability may vary based on location. See your local Elliott Electric Supply for more details.

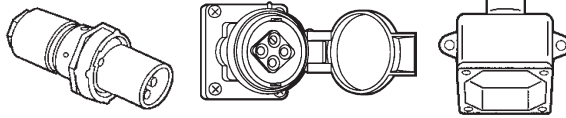

### RECEPTACLES

Vendor Code: **APP**

Catalog Number	Description	Price Each
<b>30A, 600V AC / 250V DC</b>		
ADR3023	2 Wire, 3 Pole	204.12
ADR3033	3 Wire, 3 Pole	178.66
ADR3034	3 Wire, 4 Pole	229.50
ADR3044	4 Wire, 4 Pole	204.12
<b>60A, 600V AC / 250V DC</b>		
ADR6033	3 Wire, 3 Pole	293.25
ADR6034	3 Wire, 4 Pole	382.25
ADR6044	4 Wire, 4 Pole	344.46
<b>100A, 600V AC / 250V DC</b>		
ADR1033	3 Wire, 3 Pole	369.83
ADR1034	3 Wire, 4 Pole	471.94
ADR1044	4 Wire, 4 Pole	433.62
<b>200A, 600V AC / 250V DC</b>		
AR20033	3 Wire, 3 Pole	862.65
AR20034	3 Wire, 4 Pole	912.50
AR20044	4 Wire, 4 Pole	864.21

Vendor Code: **CRS**

Catalog Number	Description	Price Each
<b>30A, 600V AC / 250V DC</b>		
AR332	2 Wire, 3 Pole	311.27
CDR3033	3 Wire, 3 Pole	202.84
CDR3034	3 Wire, 4 Pole	226.48
CDR3044	4 Wire, 4 Pole	231.88
<b>60A, 600V AC / 250V DC</b>		
CDR6033	3 Wire, 3 Pole	334.32
CDR6034	3 Wire, 4 Pole	377.46
CDR6044	4 Wire, 4 Pole	365.60
<b>100A, 600V AC / 250V DC</b>		
CDR1033	3 Wire, 3 Pole	421.36
CDR1034	3 Wire, 4 Pole	464.58
CDR1044	4 Wire, 4 Pole	494.84
<b>200A, 600V AC / 250V DC</b>		
-	3 Wire, 3 Pole	-
-	3 Wire, 4 Pole	-
AR2041	4 Wire, 4 Pole	1553.54

Vendor Code: **KIL**

Catalog Number	Description	Price Each
<b>30A, 600V AC / 250V DC</b>		
VR332	2 Wire, 3 Pole	150.38
VR331	3 Wire, 3 Pole	131.52
VR342	3 Wire, 4 Pole	190.44
VR341	4 Wire, 4 Pole	150.38
<b>60A, 600V AC / 250V DC</b>		
VR631	3 Wire, 3 Pole	216.87
VR642	3 Wire, 4 Pole	286.80
VR641	4 Wire, 4 Pole	254.38
<b>100A, 600V AC / 250V DC</b>		
VR1031	3 Wire, 3 Pole	307.76
VR1042	3 Wire, 4 Pole	390.73
VR1041	4 Wire, 4 Pole	361.45
<b>200A, 600V AC / 250V DC</b>		
VR20312	3 Wire, 3 Pole	625.13
VR20422	3 Wire, 4 Pole	719.79
VR20412	4 Wire, 4 Pole	682.20

### PLUGS

Vendor Code: **APP**

Catalog Number	Description	Price Each
<b>30A, 600V AC / 250V DC</b>		
ACP3033BC	3 Wire, 3 Pole	217.19
ACP3034BC	3 Wire, 4 Pole	267.85
ACP3044BC	4 Wire, 4 Pole	242.52
<b>60A, 600V AC / 250V DC</b>		
ACP6033BC	3 Wire, 3 Pole	306.29
ACP6034BC	3 Wire, 4 Pole	369.83
ACP6044BC	4 Wire, 4 Pole	319.61
<b>100A, 600V AC / 250V DC</b>		
ACP1033CD	3 Wire, 3 Pole	471.94
ACP1034CD	3 Wire, 4 Pole	560.86
ACP1044CD	4 Wire, 4 Pole	522.70
<b>200A, 600V AC / 250V DC</b>		
AP20034CD	3 Wire, 4 Pole	995.29
AP20044CD	4 Wire, 4 Pole	942.57

Vendor Code: **CRS**

Catalog Number	Description	Price Each
<b>30A, 600V AC / 250V DC</b>		
CCP3033BC	3 Wire, 3 Pole	227.21
CCP3034BC	3 Wire, 4 Pole	245.21
CCP3044BC	4 Wire, 4 Pole	255.31
<b>60A, 600V AC / 250V DC</b>		
CCP6033BC	3 Wire, 3 Pole	321.69
CCP6034BC	3 Wire, 4 Pole	336.30
CCP6044BC	4 Wire, 4 Pole	343.05
<b>100A, 600V AC / 250V DC</b>		
CCP1033CD	3 Wire, 3 Pole	492.66
CCP1034CD	3 Wire, 4 Pole	506.15
CCP1044CD	4 Wire, 4 Pole	545.53
<b>200A, 600V AC / 250V DC</b>		
AP20467	3 Wire, 4 Pole	1979.18
AP20457	4 Wire, 4 Pole	2066.89

Vendor Code: **KIL**

Catalog Number	Description	Price Each
<b>30A, 600V AC / 250V DC</b>		
VP3375	3 Wire, 3 Pole	160.38
VP3485	3 Wire, 4 Pole	223.01
VP3475	4 Wire, 4 Pole	201.80
<b>60A, 600V AC / 250V DC</b>		
VP6375	3 Wire, 3 Pole	225.55
VP6485	3 Wire, 4 Pole	307.64
VP6475	4 Wire, 4 Pole	265.44
<b>100A, 600V AC / 250V DC</b>		
VP10377	3 Wire, 3 Pole	390.73
VP10487	3 Wire, 4 Pole	465.58
VP10477	4 Wire, 4 Pole	433.06
<b>200A, 600V AC / 250V DC</b>		
VP204612	3 Wire, 4 Pole	719.79
VP204513	4 Wire, 4 Pole	682.20

### MOUNTING BOXES

Vendor Code: **APP**

Catalog Number	Description	Price Each
<b>30 AMP</b>		
AE23	3/4" Hub	41.58
AE33	1" Hub	44.70
<b>60 AMP</b>		
AE46	1-1/4" Hub	49.97
AE56	1-1/2" Hub	52.58
<b>60 &amp; 100 AMP</b>		
AJA610	2" Hub	212.36
<b>200 AMP</b>		
AJA620	2" Hub	389.48

Vendor Code: **CRS**

Cat. Number	Description	Price Each
<b>30 AMP</b>		
ARE23	3/4" Hub	74.04
CEE33	1-1/2" Hub	61.24
<b>60 AMP</b>		
CEE46	1-1/4" Hub	68.48
CEE56	1-1/2" Hub	71.98
<b>60 &amp; 100 AMP</b>		
AJ67	2" Hub w/Angle Adapter	333.29
<b>200 AMP</b>		
AJ68	2" Hub w/Angle Adapter	601.75

Vendor Code: **KIL**

Catalog Number	Description	Price Each
<b>30 AMP</b>		
VRE23	3/4" Hub	34.52
VRE33	1" Hub	37.17
<b>60 AMP</b>		
VRE46	1-1/4" Hub	39.43
VRE56	1-1/2" Hub	44.44
<b>60 &amp; 100 AMP</b>		
VJ67	2" Hub	154.76
<b>200 AMP</b>		
VJ68	2" Hub	275.51

Read across columns for equivalent products.



## LED Lighting for Hazardous Locations (High Bay · Flood · Low Bay)

### CHAMP® HIGH BAY LEDS

Vendor Code: **CRS**

Catalog Number	HID Equivalent	Input Wattage	Price Each
<b>NEMA 4X, IP 66</b>			
PVM3LUNV1	70W - 100W	41W	1618.83
PVM5LUNV1	100W - 150W	67W	1646.02
PVM7LUNV1	150W - 175W	94W	1880.16
PVM9LUNV1	250W - 320W	114W	2361.72
PVM11LUNV1	320W - 400W	118W	3074.33
PVM13LUNV1	400W	130W	3899.82
<b>CLASS I, DIVISION 2, GROUPS A, B, C, D</b>			
VMV3LUNV1	70W - 100W	41W	1902.27
VMV5LUNV1	100W - 150W	67W	2123.88
VMV7LUNV1	150W - 175W	94W	2401.19
VMV9LUNV1	250W - 320W	114W	3200.14
VMV11LUNV1	320W - 400W	118W	3702.89
VMV13LUNV1	400W	130W	4485.68

#### MOUNTING OPTIONS

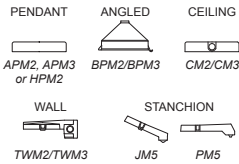
Vendor Code: **CRS**

Catalog Number	Description	Price Each
APM2	3/4" Pendant	132.75
APM3	1" Pendant	122.52
CM2	3/4" Ceiling	114.31
CM3	1" Ceiling	114.31
TWM2	3/4" Thru Wall Mount	220.64
TWM3	1" Thru Wall Mount	289.10
JM5	25 Degree Angle Stanchion	196.64
PM5	Straight Stanchion	289.10

### MLL LINEAR LED



MLL2UNV1

MLL4UNV1

Vendor Code: **CRS**

Catalog Number	Input Wattage	Length	Price Each
<b>CLASS I, DIVISION 2, GROUPS A, B, C, &amp; D</b>			
MLL2UNV1	29W	2 Feet	1360.33
MLL4UNV1	55W	4 Feet	1978.48

100/277 VAC

### CHAMP® FLOOD LEDS

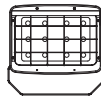
Vendor Code: **CRS**

Catalog Number	HID Equivalent	Input Wattage	Price Each
<b>NEMA 4X, IP 66</b>			
PFM5LCYUNV176	100W - 150W	45W	2430.04
PFM7LCYUNV176	150W - 175W	62W	3064.44
PFM9LCYUNV176	175W - 250W	79W	3388.44
PFM11LCYUNV176	250W - 320W	99W	3008.50
PFM13LCYUNV176	320W - 400W	112W	4416.48
<b>CLASS I, DIVISION 2, GROUPS A, B, C, D</b>			
FMV5LCYUNV176	100W - 150W	45W	2824.04
FMV7LCYUNV176	150W - 175W	62W	3496.38
FMV9LCYUNV176	175W - 250W	79W	3051.61
FMV11LCYUNV176	250W - 320W	99W	3423.99
FMV13LCYUNV176	320W - 400W	112W	4782.19

### NEW V-SPRING TELESCOPING SAFETY LIGHT POLE

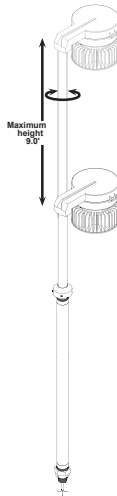

- Increases safety and decreases labor costs associated with lighting installation and routine maintenance.
- Its innovative design allows for all work to safely take place on the platform or walkway, eliminating the need for portable ladders and fall protection equipment.
- Listed for Class I Div 2, Class II Div 2 when used with Champ luminaires.

Vendor Code: **CRS**

Catalog Number	Description	Price Each
V65BAC	Base Mount Alum w/ Cover	2283.62
V65HG*	Handrail Stanchion Galv Steel	741.66
V65WG	Wall Mount Galv Steel	1771.68

\*Handrail Mounting Kits Sold Separately.



Crouse-Hinds series

### EV SERIES LED LUMINAIRES

Vendor Code: **CRS**

Catalog Number	HID Equivalent	Input Wattage	Price Each
<b>CLASS 1, DIVISION 1, GROUPS C &amp; D</b>			
EVLEDC201	100W-200W Incandescent	15W	1870.72
EVLEDC701	70W-100W HID	30W	2696.26

#### MOUNTING OPTIONS

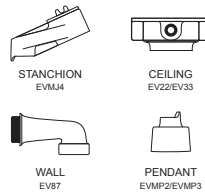
Vendor Code: **CRS**

Catalog Number	Description	Price Each
EVM2	3/4" Pendant	301.41
EVMP3	1" Pendant	393.60
EV22	3/4" Ceiling & Wall	432.92
EV33	1" Ceiling & Wall	490.93
EVJM4	25° Angle Stanchion	537.07
EV87	Wall Mount Adaptor Arm	343.66

### LED LOW BAYS

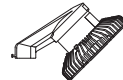

Stanchion Mount

Vendor Code: **CRS**

Catalog Number	Mounting	Price Each
<b>NEMA 4X, IP 66</b>		
P2LM2CA2UNV1	3/4" Pendant	1333.94
P2LCA3UNV1	1" Pendant	2169.00
P2LM2CHF2UNV1	3/4" Ceiling	1435.46
P2LM2CHT2UNV1	3/4" Thru Wall	1481.14
P2LM2CHJ4UNV1	Stanchion	1610.38
<b>CLASS I, DIVISION 2, GROUPS A, B, C, D</b>		
V2LM2CA2UNV1	3/4" Pendant	1566.36
V2LM2CA3UNV1	1" Pendant	1566.36
V2LM2CHF2UNV1	3/4" Ceiling	1657.92
V2LM2CHT2UNV1	3/4" Thru Wall	1727.58
V2LM2CHJ4UNV1	Stanchion	1841.78

50W HID or 150-200W Incandescent Equivalent. Input Wattage = 14

Harsh Locations



Cast Device Boxes · Wet Location Covers · Cast Device Box Covers

**CAST DEVICE BOXES  
SINGLE GANG**

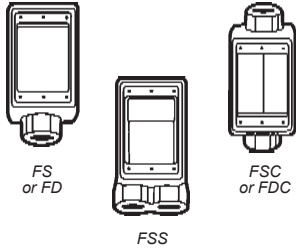

Vendor Code: **CRS**

Catalog Number	Description	Price Each
<b>1-7/8" DEEP</b>		
<b>FS1</b>	1/2" Hub	29.88
<b>FS2</b>	3/4" Hub	31.47
<b>FSC1</b>	1/2" Hub	32.96
<b>FSC2</b>	3/4" Hub	36.04
<b>FSS1</b>	1/2" Hub	43.21
<b>FSS2</b>	3/4" Hub	36.39
<b>2-11/16" DEEP</b>		
<b>FD1</b>	1/2" Hub	32.85
<b>FD2</b>	3/4" Hub	35.85
<b>FDC1</b>	1/2" Hub	37.40
<b>FDC2</b>	3/4" Hub	40.35

**CAST DEVICE BOXES  
TWO GANG**

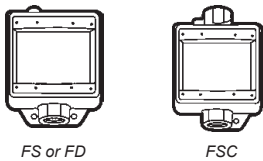

Vendor Code: **CRS**

Catalog Number	Description	Price Each
<b>1-7/8" DEEP</b>		
<b>FS12</b>	1/2" Hub	60.27
<b>FS22</b>	3/4" Hub	56.33
<b>FSC12</b>	1/2" Hub	69.74
<b>FSC222</b>	3/4" Hub	63.52
<b>2-11/16" DEEP</b>		
<b>FD12</b>	1/2" Hub	65.53
<b>FD22</b>	3/4" Hub	64.79

**EATON**  
Crouse-Hinds series

**WET LOCATION COVERS**

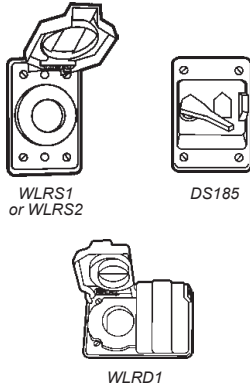

Vendor Code: **CRS**

Catalog Number	Description	Price Each
<b>SINGLE DEVICE</b>		
<b>WLRs1</b>	5-15R / 6-15R 5-20R / 6-20R L5-15R / L6-15R	72.89
<b>WLRs2</b>	L5-20R / L6-20R	72.89
<b>DUPLEX DEVICE</b>		
<b>WLRD1</b>	5-15R / 6-15R 5-20R / 6-20R L5-15R	84.47
<b>SWITCH</b>		
<b>DS185</b>	Toggle Switch Cover	67.12

**CAST DEVICE BOX COVERS**

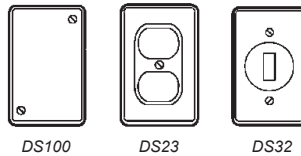

Vendor Code: **CRS**

Catalog Number	Material	Device Type	Price Each
<b>1-GANG</b>			
<b>DS100</b>	Aluminum	Blank	6.00
<b>DS100G</b>	Cast Iron	*Blank	19.43
<b>DS23</b>	Steel	Duplex	7.52
<b>DS32</b>	Steel	Toggle Switch	7.52
<b>DS21</b>	Steel	**Single Receptacle	7.52
<b>DS35</b>	Steel	***Single Receptacle	7.52
<b>2-GANG</b>			
<b>S1002</b>	Steel	Blank	8.79
<b>S232</b>	Steel	2 - Duplex	11.91
<b>S322</b>	Steel	2 - Toggle Switch	11.91

\*Includes Gasket.  
\*\*DS21 Has 1-7/16" Opening.  
\*\*\*DS35 Has 1-5/8" Opening.

**NEW**

**NON-HAZARDOUS  
LOCATION DRAINS**

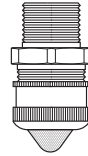

- Drain accumulated condensate.
- Provide ventilation to minimize condensation.
- Drains are installed in hubs or drilled and tapped openings.

Vendor Code: **CRS**

Catalog Number	Description	Ctn. Qty.	Price Each
<b>CD1</b>	1/2" Male Thread	10	22.11
<b>CD2</b>	3/4" Male Thread	10	22.11

**NEW**

**ARK•GARD® PLUGS  
AND RECEPTACLES**

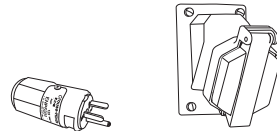

ENP5201

ENR5201

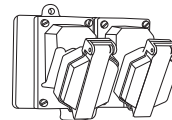

ENR22201

- Captive set screw design standard on all ENP plugs.
- Insulator and contact components now a single piece assembly.
- ENP plugs can be used in non-hazardous areas with standard U-ground NEMA/EEMAC configuration 5 and 6 receptacles.
- ENP plug can accept various cable diameters.
- Class I Groups C & D. Class II Groups F, G, Class III.

Vendor Code: **CRS**

Catalog Number	Description	Price Each
<b>ENP5201*</b>	20 Amp 125V Plug	204.82
<b>ENR5201</b>	20 Amp 125V Receptacle	559.25
<b>ENR22201</b>	20A 125V Dead End 2G Receptacle Assembly	1267.02

\*Suitable for Class I, Group B.

Harsh Locations

**NEW**

### ARMORED CABLE GLANDS

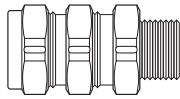
**TMC Features:**

- Stainless steel copper-plated spring provides grounding continuity of cable armor (MC cable only)
- Watertight seal on outer sheath of cable
- Cold Shrink kit is available
- Available with NPT threads
- May be used in wet locations
- Can be used in Class I Division 2 locations, if there are no arcing and sparking risks in accordance with NEC501.10B

**TMCX Features:**

- Stainless steel copper-plated spring provides grounding continuity of cable armor (MC cable only)
- Provides explosionproof compound seal on conductors and watertight seal on outer sheath of cable
- Cold Shrink kit is available for extra protection in aggressive environments
- Supplied with TSC epoxy sealing compound
- Can be used in Class I groups A, B, C, & D, Class II groups E, F, & G, and Class III

**TMCX Terminator II Features:**

- Full coverage of all popular cables and hub sizes
- Chico LiquidSeal reduces waiting times
- Complete with integral dam to facilitate liquid pour
- Integral union design
- Mating components have generous lead-ins for trouble-free assembly
- Metric Size threads allow interfacing to European machinery
- Cold Shrink kit is available for extra protection in aggressive environments
- Can be used in Class I groups A, B, C, & D, Class II groups E, F, & G, Class III

Vendor Code: **CRS**

Catalog Number	Cord Range	NPT Size	Ctn. Qty.	Price Each
<b>TMC165</b>	0.44 - 0.65	1/2"	5	35.66
<b>TMC285</b>	0.60 - 0.85	3/4"	5	49.86
<b>TMC3112</b>	0.80 - 1.12	1"	5	75.60
<b>TMC4140</b>	1.10 - 1.40	1-1/4"	2	97.44
<b>TMC5161</b>	1.33 - 1.61	1-1/2"	2	138.71
<b>TMC6206</b>	1.57 - 2.06	2"	1	168.82
<b>TMC7247</b>	1.93 - 2.47	2-1/2"	1	382.46

**HARSH LOCATIONS**

<b>TMCX165</b>	0.44 - 0.65	1/2"	5	94.11
<b>TMCX285</b>	0.60 - 0.85	3/4"	5	140.66
<b>TMCX3112</b>	0.80 - 1.12	1"	5	179.87
<b>TMCX4140</b>	1.10 - 1.40	1-1/4"	1	247.38
<b>TMCX5161</b>	1.33 - 1.61	1-1/2"	1	346.97
<b>TMCX6206</b>	1.57 - 2.06	2"	1	454.53
<b>TMCX7247</b>	1.93 - 2.47	2-1/2"	1	939.38

**TERMINATOR II SERIES\***

<b>TMCX0500</b>	0.36 - 0.66	1/2"	1	164.14
<b>TMCX0501</b>	0.40 - 0.86	1/2"	1	176.16
<b>TMCX0502</b>	0.56 - 1.14	1/2"	1	154.60
<b>TMCX0751</b>	.040 - 0.86	3/4"	1	206.72
<b>TMCX0752</b>	0.56 - 1.14	3/4"	1	253.34
<b>TMCX1001</b>	0.56 - 1.14	1"	1	183.04
<b>TMCX1002</b>	0.78 - 1.35	1"	1	343.62

\*Comes with TSC solid compound. Adding "L" to the end of the part number will get you LSC liquid compound. Adding "BULK" to the end of the part number will get you no compound.

### NON-ARMORED CABLE GLANDS

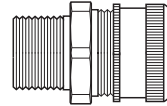
**CGB Features:**

- Rugged, durable construction protects cords and cables from damage, and compact design permits close grouping of several cords and/or cables
- Flexible offering available in steel, iron, and aluminum in 3/8" to 3" trade sizes
- Wire mesh grips available for added strain relief
- Available with NPT threads
- Standard neoprene bushing weatherproof seal on outer sheath of cable
- Suitable for use in Class I, Division 2 hazardous locations when installed in accordance with NEC501.10(B)(4)
- NEMA 3R (suitable for use in wet locations)
- Operating temperature: -25 degrees C to +40 degrees C.

**CGE Features:**

- Rugged, durable construction protects cords and cables from damage, and compact design permits close grouping of several cords and/or cables
- Wire mesh grips available for added strain relief
- Available with NPT threads
- Standard neoprene bushing weatherproof seal on outer sheath of cable
- Suitable for use in wet locations
- Standard materials: body - ferrous iron alloy, gland nut - steel.
- Operating temperature -24 degrees C to +40 degrees C.

Vendor Code: **CRS**

Catalog Number	Cord Range	NPT Size	Ctn. Qty.	Price Each
<b>CGB192</b>	.125 - .250	1/2"	25	11.33
<b>CGB193</b>	.250 - .375	1/2"	25	11.33
<b>CGB194</b>	.375 - .500	1/2"	25	11.33
<b>CGB195</b>	.500 - .625	1/2"	25	11.33
<b>CGB294</b>	.375 - .500	3/4"	25	11.33
<b>CGB295</b>	.500 - .625	3/4"	25	11.33
<b>CGB296</b>	.625 - .750	3/4"	10	20.57
<b>CGB499</b>	1.00 - 1.18	1-1/4"	5	49.21
<b>CGB4911</b>	1.18 - 1.37	1-1/4"	5	41.79
<b>CGB599</b>	1.00 - 1.18	1-1/2"	5	41.79
<b>CGB5911</b>	1.18 - 1.37	1-1/2"	5	47.75
<b>CGB6913</b>	1.37 - 1.62	2"	2	76.43
<b>CGB6915</b>	1.62 - 1.87	2"	2	76.43
<b>CGB6917</b>	1.87 - 2.18	2"	1	99.12
<b>CGB7917</b>	1.87 - 2.18	2-1/2"	1	99.13

**90 DEGREE ANGLE BODY**

<b>CGE193</b>	.250 - .375	1/2"	10	26.43
<b>CGE296</b>	.625 - .750	3/4"	10	48.11



Contact us for Harsh and Hazardous Cable

**EAT·N**  
Crouse-Hinds series

Harsh Locations

Clamped EBMX Explosionproof Enclosures · Lighting and Heat Tracing Panelboards

**NEW** CLAMPED EBMX EXPLOSIONPROOF ENCLOSURES  
 CLASS I DIV 1&2 GROUPS B\*, C, & D  
 CLASS II GROUPS E, F, & G  
 CLASS III

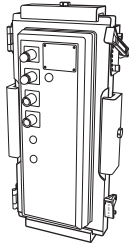

Combo Starter Enclosure

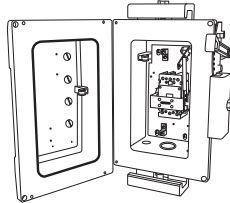

Breaker Enclosure

The EBMX advantage:

- The world's only NEMA 7 classified enclosure to utilize clamping technology
- **Faster.** A significant reduction in installation and maintenance costs due to its revolutionary clamped design makes opening and closing the EBMX significantly faster than traditional enclosures.
- **Safer.** The clamps on the EBMX enclosure automatically apply even pressure across the flame path for an error-proof installation. No need to worry about missing or improperly torqued bolts creating an explosion in your facility.
- Side operated handles for visual confirmation of proper operator alignment while cover is open.
- Rated Class I, Divisions 1 and 2, and has a NEMA 4X rating to protect against water ingress.
- Designed for use as a breaker, disconnect switch, motor starter, or combo starter.
- Handle and mechanism ships with the enclosure. Breaker, starter, or combo enclosures have appropriate handles included.
- Multiple configurations available. See store for details.

Vendor Code: **CRS**

Catalog Number	Description	Price Each
<b>ENCLOSURE ONLY (HANDLE AND MECHANISM INCLUDED)</b>		
<b>EBMX1BW</b>	Clamped 15A-100A Breaker Enclosure	6849.42
<b>EBMX2BW</b>	Clamped 125A-200A Breaker Enclosure	13069.32
<b>EBMX3BW</b>	Clamped 225-500A Breaker Enclosure	23894.40
<b>EBMX2C</b>	Clamped NEMA 0-2 Combo Starter Enclosure	8293.62
<b>EBMX3C</b>	Clamped NEMA 3 & 4 Combo Starter Enclosure	20757.80

\*High AIC and -50°C Temperature Certifications Do Not Apply for Group B.

**NEW** SYNERGEX LIGHTING AND HEAT TRACING PANELBOARDS

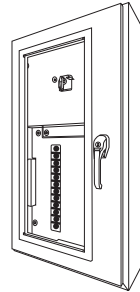

- Lightweight design and reduced footprint for easier installation with reduced labor costs.
- Easy to open and access with only 1/4 turn (vs. up to 70+ bolts in a traditional enclosure).
- High ingress protection for harsh environments
- Encapsulated branch circuit breakers
- Optional removable gland plates for easy addition of entries
- Lightweight and compact main breaker is encapsulated and internally mounted
- Breakers permanently welded closed to prevent tampering
- Touch safe and fully encapsulated bus
- Easy to install rigid connection to the bus bar for easier maintenance/ installation
- Rated for Class I, Division 2, Groups A, B, C, D areas.
- **Multiple configurations available. See store for details.**

Harsh Locations





SECTION

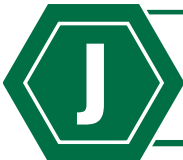

Datacom

Datacom

J



**Datacom**

**Datacom**

**Home Networks**

Enclosures .....	J3
Wall Plates & Inserts .....	J4
Video Distribution.....	J4
Straps .....	J5
Coax.....	J6

**Patch Panels & Cords**

Punch Down Tools .....	J5-J6
Patch Cords .....	J6
Patch Panels .....	J6

**Uninterruptable Power Supplies**

UPS .....	J7
Network, Server and Storage UPS .....	J7

**Data Cables**

Data Cables .....	J8
-------------------	----

**Datacom**

**J**





## Home Network Enclosures (Metal and Plastic)

### ON-Q / LEGRAND HOME NETWORK PRODUCTS

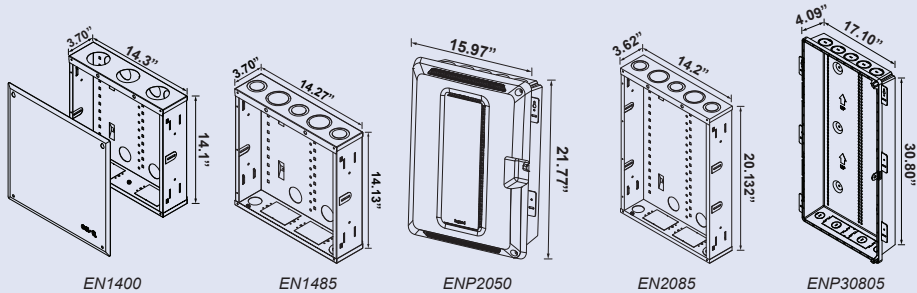

#### CONFIGURE CUSTOM NETWORKS INSTANTLY!

ON-Q Home Network Center is the fast, flexible way to create any type of home network. Just click in your choice of video, audio, computer network, phone, and power modules for a perfectly tailored solution. Upgrade easily any time.

- AC power outlet knockout for duplex
- Flush and surface installation options
- UL listed for fire and security alarm equipment
- Venting allows for superior heat dissipation
- Made in the USA



Create a video network that can receive and redistribute antenna, CATV, satellite, DVD, VCR, and camera signals to any television - anywhere in the house.



Benefit from the safety of home security by installing a camera module that lets you monitor up to four security cameras from any home TV set.



The audio distribution module provides CD-quality audio to any four rooms in the house.



Computer modules allow you to build a power computer network. Link up to eight computers and peripherals at 100 megabit speeds.



Telephone modules provide virtually unlimited flexibility to distribute incoming phone calls. Up to eight incoming lines can be routed to 36 different locations with the Home Office option.

### HOME NETWORK ENCLOSURES METAL

Vendor Code: PAS

Catalog Number	Description	Price Each
EN1022	14" 6x4 Esc. Basic Combo	101.04
EN1200	12" Enclosure with Screw-On Cover	48.02
EN1400	14" Enclosure with Screw-On Cover	45.35
EN1420	14" Screw-On Cover	30.23
EN1450	14" Enclosure with Hinged Door	86.40
EN1485	14" Enclosure with Knockouts (No Cover)	35.64
EN2000	20" Enclosure with Screw-On Cover	70.19
EN2020	20" Screw-On Cover	37.80
EN2050	20" Enclosure with Hinged Door	97.19
EN2085	20" Enclosure with Knockouts (No Cover)	42.97
EN2800	28" Enclosure with Screw-On Cover	97.19
EN2850	28" Enclosure with Hinged Door	129.59
EN4200	42" Enclosure with Screw-On Cover	140.39
EN4250	42" Enclosure with Hinged Door	194.39

Flush or Surface

### HOME NETWORK ENCLOSURES PLASTIC

Vendor Code: PAS

Catalog Number	Description	Price Each
ENP2050	20" with Hinged Cover	63.33
ENP20605	20" Hinged Cover (5PK)	141.70
ENP20805	20" No Cover (5PK)	166.70
ENP30605	30" Hinged Cover (5PK)	163.27
ENP30805	30" No Cover (5PK)	183.67
ENP4250	42" with Hinged Cover	131.69
ENP42605	42" Hinged Cover (5PK)	264.29
ENP42805	42" No Cover (5PK)	285.71





**WALL PLATES**

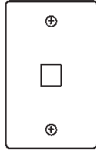

Vendor Code: **PAS**

Catalog Number	Description	Price Each
<b>WP3401WH</b>	1-Gang, 1-Port	1.36
<b>WP3402WH</b>	1-Gang, 2-Port	1.36
<b>WP3403WH</b>	1-Gang, 3-Port	1.36
<b>WP3404WH</b>	1-Gang, 4-Port	1.36
<b>WP3406WH</b>	1-Gang, 6-Port	1.36

Catalog Numbers Listed Above are White (**WH**). Replace **WH** with **BK** for Black, **BR** for Brown, **IV** for Ivory or **LA** for Light Almond.

**VIDEO DISTRIBUTION**

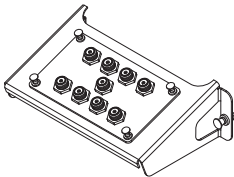

Vendor Code: **PAS**

Catalog Number	Description	Price Each
<b>VM1002</b>	1 x 8 Passive Video Splitter Module	46.44

**RCA TO F CONNECTOR**

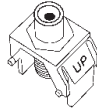

Vendor Code: **PAS**

Catalog Number	Description	Price Each
<b>WP3462WH</b>	Red RCA to F-Connector	3.18
<b>WP3461WH</b>	White RCA to F-Connector	3.18
<b>WP3463WH</b>	Green RCA to F-Connector	3.18
<b>WP3464WH</b>	Blue RCA to F-Connector	3.18
<b>WP3465WH</b>	Yellow RCA to F-Connector	3.18

Catalog Numbers Listed Above are White (**WH**). Replace **WH** with **BK** for Black, **BR** for Brown, **IV** for Ivory or **LA** for Light Almond.

**F CONNECTORS**

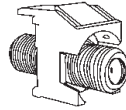

Vendor Code: **PAS**

Catalog Number	Description	Price Each
<b>WP3479WH</b>	Coax Keystone F-Connector	1.26
<b>WP3481WH</b>	Recessed Keystone F-Connector	1.78

Catalog Numbers Listed Above are White (**WH**). Replace **WH** with **BK** for Black, **BR** for Brown, **IV** for Ivory or **LA** for Light Almond.

**BLANKS**



Vendor Code: **PAS**

Catalog Number	Description	Price Each
<b>WP3455WH</b>	Blank Insert	3.16

Catalog Number Listed Above is White (**WH**). Replace **WH** with **BK** for Black, **BR** for Brown or **IV** for Ivory.

**INSERTS**

**RJ25**

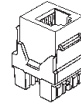

Vendor Code: **PAS**

Catalog Number	Description	Price Each
<b>WP3425WH</b>	6P6C Keystone Connector	2.63

Catalog Number Listed Above is White (**WH**). Replace **WH** with **BK** for Black, **BR** for Brown, **IV** for Ivory or **LA** for Light Almond.

**CAT 5E**

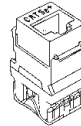

Vendor Code: **PAS**

Catalog Number	Description	Price Each
<b>WP3450WH</b>	RJ45 Keystone Connector	3.72

Catalog Number Listed Above is White (**WH**). Replace **WH** with **BE** for Blue, **BK** for Black, **BR** for Brown, **IV** for Ivory, **GY** for Grey, **LA** for Light Almond, **OR** for Orange or **RE** for Red.

**CAT 6**

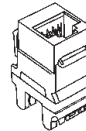

Vendor Code: **PAS**

Catalog Number	Description	Price Each
<b>WP3460WH</b>	RJ45 Keystone Connector	6.26

Catalog Number Listed Above is White (**WH**). Replace **WH** with **BE** for Blue, **BK** for Black, **BR** for Brown, **GY** for Grey, **IV** for Ivory, **LA** for Light Almond, **OR** for Orange or **RE** for Red.

**Datacom**

**J**



**Try QuickSelect Now!**  
**Standard Devices & Plates - White**





### DECORATOR OUTLET STRAPS



WP3412

Vendor Code: PAS

Catalog Number	Description	Color	Price Each
WP3410WH	Blank Outlet Strap	White	0.98
WP3411WH	1-Port Outlet Strap	White	1.29
WP3412WH	2-Port Outlet Strap	White	1.29
WP3413WH	3-Port Outlet Strap	White	1.29
WP3414WH	4-Port Outlet Strap	White	1.29

Catalog Numbers Listed Above are White (WH). Replace WH with LA for Light Almond. Pick Inserts from Page J2.

### DECORATOR WALL PLATES

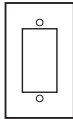

Vendor Code: PAS

Catalog Number	Description	Color	Price per 100 pcs.
TP26W	1-Gang Wall Plate	White	44.56
TP262W	2-Gang Wall Plate	White	88.62
TP263W	3-Gang Wall Plate	White	133.13
TP13W	1-Gang Blank Wall Plate	White	54.62

Catalog Numbers Listed Above are White (W). Replace W with BK for Black, BR for Brown, GR for Grey, I for Ivory, LA for Light Almond or RED for Red.

### HDMI & 2 BLANK PORT OUTLETS

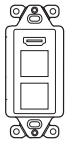

Vendor Code: PAS

Catalog Number	Description	Price Each
WP1011WH	HDMI 2-Port Strap	24.38

Catalog Number Listed Above is White (WH). Replace WH with BK for Black or LA for Light Almond. Includes Two Blank Ports For Use with Any Keystone Insert. In-Wall HDMI Connection.

### PRECONFIGURED OUTLET STRAPS

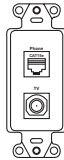

WP3211WH

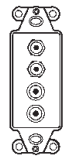

WP1010WH

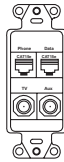

WP3422WH

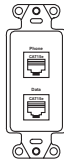

WP3220WH

Vendor Code: PAS

Catalog Number	Description	Price Each
WP3210WH	Pre Configured 1-Port, Strap 1 RJ45	6.27
WP3211WH	Pre Configured 2-Port, Strap Phone/TV	6.67
WP3220WH	Pre Configured 2-Port, Strap Phone/Data	9.19
WP3422WH	Pre Configured 4-Port, Strap Phone/TV, TV/AUX	11.97
WP1010WH	Pre Configured 4-Port, Component Video/Digital Audio Strap	28.97

Catalog Numbers Listed Above are White (WH). Replace WH with BK for Black or LA for Light Almond.

### CABLE ACCESS STRAP



Vendor Code: PAS

Catalog Number	Description	Price Each
WP1014WH	Cable Access Strap	4.52



### PUNCH DOWN TOOLS

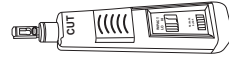

VDV427800SEN

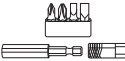

VDV427807

Vendor Code: KLE

Catalog Number	Description	Price Each
VDV427800SEN	Impact Punchdown Tool with 110/66 Blade	46.50
VDV427807	Punchdown Multi-Tool with 110/66 Blade & WorkEnds Kit	61.82

### QUICK CONNECT PUNCH & GO TOOL

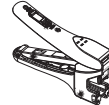

- Seat and cut all wires at once with a squeeze of the handle.
- Consistent terminations every time.

Vendor Code: PAS

Catalog Number	Description	Price Each
AC3400	Used Exclusively with WP3475, WP3476 and WP346A Quick Connect Jacks	34.68

### PRO AMPLIFIER PROBE & TONE GENERATOR KIT

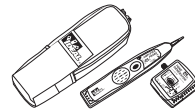

Vendor Code: IDE

Catalog Number	Description	Price Each
33864*	Tone and Probe Units in One Single Kit	127.29

\*Kit Includes Cat. No. 62164 Amplifier, Cat. No. 62160 Tone Generator, Carrying Case, Lead Set, and Cable Assembly

Data Accessories (Hybrid Splitters · Modular Patch Panels · Punch Down Tools)

COAX ACCESSORIES

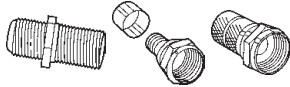

Vendor Code: **STE**

Catalog Number	Description	Price per 100 pcs.
200025	RG6 Crimp-On Connector	35.00
200035	RG6 Crimp-On Connector	32.00
200040	RG59 Twist-On Connector	25.00
200039	RG6 Twist-On Connector	27.50
200053	In Line Splice	25.71

HYBRID SPLITTERS

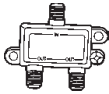

Vendor Code: **STE**

Catalog Number	Description	Price per 100 pcs.
200202	2-Way Splitter	116.97
200204	4-Way Splitter	156.70

WIRE PLUGS



Vendor Code: **CBL**

Catalog Number	Description	Price Each
CNRJ11ST	RJ11 4-Wire Mod Plug Solid	12.99

CAT 5 & 6 PATCH CORDS

Vendor Code: **CBL**

Catalog Number	Color	Length	Price Each
<b>CATEGORY 5E</b>			
N101113BLC	Blue	3'	1.99
N101113BKC	Black	3'	1.79
N101115WHTC	White	5'	1.99
N101115BLC	Blue	5'	1.99
N101117BLC	Blue	7'	2.29
<b>CATEGORY 6E</b>			
N111111MWHTC	White	1'	1.85
N111111MBLC	Blue	1'	1.79
N111113MWHTC	White	3'	2.46
N111113MBLC	Blue	3'	2.39
N111115MBKC	Black	5'	2.99
N11117MBLC	Blue	7'	3.60

M=Molded Boot  
Available in Other Lengths and Colors, Please ask Your Elliott Electric Supply Sales Person.

RJ45 JACKS



Vendor Code: **CBL**

Catalog Number	Description	Price Each
CNC6CWHT	RJ45 Cat. 6 Jack	3.19
CNC5ECWHT	RJ45 Cat. 5E Jack	2.09
CNC5EHDWHT	RJ45 Cat. 5E HD Jack	2.29
CNC6CHDWHT	RJ45 Cat. 6 HD Jack	3.61

Catalog Numbers Listed are White (WHT). Replace WHT with BK for Black, BL for Blue, IV for Ivory, LA for Light Almond or OR for Orange.

MODULAR PATCH PANELS LOADED



Wall Mount



Rack Mount

Vendor Code: **CBL**

Catalog Number	Ports	Mount	Price Each
<b>CATEGORY 5E</b>			
PPC5E12MC	12	Wall	39.99
PPC5E24C	24	Rack	72.99
PPC5E48C	48	Rack	144.99
<b>CATEGORY 6E</b>			
PPC612MC	12	Wall	49.94
PPC624C	24	Rack	115.00
PPC648C	48	Rack	224.99

UNLOADED



Vendor Code: **CBL**

Catalog Number	Ports	Mount	Price Each
PPK12MFM	12	Wall	23.99
PPK24FMC	24	Rack	39.99
PPK48FMC	48	Rack	49.99

Unloaded Panels Require Keystone Jacks Purchased Separately

WALL PLATES

Vendor Code: **CBL**

Catalog Number	Description	Price Each
FP1WHT	1-Gang, 1-Port Wall Plate	0.99
FP2WHT	1-Gang, 2-Port Wall Plate	0.99
FP3WHT	1-Gang, 3-Port Wall Plate	0.99
FP4WHT	1-Gang, 4-Port Wall Plate	0.99
FP6WHT	1-Gang, 6-Port Wall Plate	0.99

Catalog Numbers Listed Above are White (WHT). Replace WHT with BK for Black, IV for Ivory, or LA for Light Almond.

SHIELDED 90° PERFORMANCE JACKS AND PUNCH DOWN TOOL



Vendor Code: **CBL**

Catalog Number	Description	Price Each
CNC6WHTC	White Cat 6 Keystone RJ45	4.31
CNC5EWHTC	Cat 5E Keystone Performance Jack	2.52
TOCRIMP90RPTC	Performance Rapid Punch Tool	55.52

HIGH DENSITY JACKS AND RAPID PUNCH TOOL



Vendor Code: **CBL**

Catalog Number	Description	Price Each
CNC6CHDWHT	Category 6	3.61
CNC5EHDWHT	Category 5E	2.29
TOCRIMPRPT	High Density Rapid Punch Tool	59.99

90° STANDARD JACKS AND RAPID PUNCH TOOL

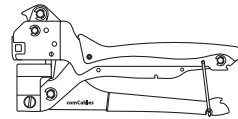

Vendor Code: **CBL**

Catalog Number	Description	Price Each
CNC6CWHT	Category 6	3.19
CNC5ECWHT	Category 5E	2.09
TOCRIMP90RPT	90° Rapid Punch Down Tool	51.54





# ELLIOTT ELECTRIC SUPPLY

## Uninterruptable Power Supplies (UPS)

**NEW** WORKSTATION AND HOME USE UPS  
EATON 3S UPS

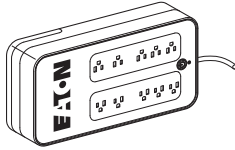

The Eaton 3S UPS provides up to 30 minutes of high efficiency and energy-saving battery backup and surge protection for your home and office equipment. The plug-and-play functionality of the 3S standby UPS allows you to start backing up your equipment the moment it's taken out of the box, with automatic integration with Windows, Mac and Linux through a simple connection to a USB port on most models.

Vendor Code: **EPQ**

Catalog Number	Power Rating (VA/Watts)	Input Plug	Out Recep. Backup + Surge	Out Recep. Surge Only	Price Each
<b>3S NORTH AMERICAN MODELS: 120V, 50/60 HZ</b>					
<b>3S350</b>	350 / 200	5-15P	(4) 5-15R	(4) 5-15R	79.25
<b>3S550</b>	550 / 330	5-15P	(4) 5-15R	(4) 5-15R	94.90
<b>3S750</b>	750 / 450	5-15P	(5) 5-15R	(5) 5-15R	136.53

**NEW** EATON 5S UPS

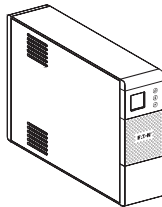

The small, compact Eaton 5S UPS delivers backup power for desktop PCs and workstations. The Eco-Control capability of this small UPS enables you save up to 30 percent in energy consumption. You can also enhance your power protection and safeguard your data when you pair it with the Eaton UPS Companion software. The 5S displays critical UPS information on battery time and outage tracking through a user-friendly LCD interface.

Vendor Code: **EPQ**

Catalog Number	Power Rating (VA/Watts)	Input Plug	Out Recep. Backup + Surge	Out Recep. Surge Only	Price Each
<b>5S TOWER, 120V, 50/60 HZ MODELS</b>					
<b>5S550</b>	550 / 330	5-15P	(4) 5-15R	(4) 5-15R	107.00
<b>5S700</b>	700 / 420	5-15P	(4) 5-15R	(4) 5-15R	190.04
<b>5S700LCD</b>	700 / 420	5-15P	(4) 5-15R	(4) 5-15R	165.87
<b>5S1000LCD</b>	1,000 / 600	5-15P	(5) 5-15R	(5) 5-15R	201.71
<b>5S1500LCD</b>	1,500 / 900	5-15P	(5) 5-15R	(5) 5-15R	273.11

**NEW** NETWORK, SERVER AND STORAGE UPS  
EATON 5P UPS

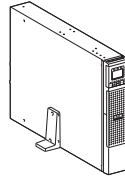

5P Tower

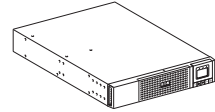

5P Rackmount

The Eaton 5P UPS delivers reliable enterprise class backup power with an efficiency rating of up to 99%. With ENERGY STAR® qualified models, the 5P's graphical LCD display allows you to view UPS status in a single glance and provides more available power than comparable UPSs. When paired with Intelligent Power Software Suite, the 5P allows you to seamlessly manage your connected equipment, even in virtualized environments.

Vendor Code: **EPQ**

Catalog Number	Power Rating (VA/Watts)	Input Plug	Out Recep. Backup + Surge	Price Each
<b>5P TOWER, 120V, 50/60 HZ MODELS</b>				
<b>5P750</b>	750 / 600	5-15P	(8) 5-15R	440.92
<b>5P1000</b>	1,000 / 770	5-15P	(8) 5-15R	586.98
<b>5P1500</b>	1,440 / 1,100	5-15P	(8) 5-15R	747.52
<b>5P3000</b>	3,000 / 2,700	L5-30P	(6) 5-20R (1) L5-30R	1550.31
<b>5P RACKMOUNT 1U, 120V, 50/60 HZ MODELS</b>				
<b>5P550R</b>	550 / 420	5-15P	(5) 5-15R	496.77
<b>5P750R</b>	750 / 600	5-15P	(5) 5-15R	744.32
<b>5P1000R</b>	1,000 / 770	5-15P	(5) 5-15R	947.69
<b>5P1500R</b>	1,440 / 1,100	5-15P	(5) 5-15R	1145.23
<b>5P RACKMOUNT 2U, 120V, 50/60 HZ MODELS</b>				
<b>5P1500RT</b>	1,440 / 1,440	5-15P	(8) 5-15R	1074.38
<b>5P2200RT</b>	1,950 / 1,920	5-20P	(8) 5-20R	1538.64
<b>5P3000RT</b>	3,000 / 2,700	L5-30P	(6) 5-20R, (1) L5-30R	1843.70
<b>5P EXTENDED RUN TIME RACKMOUNT 2U, 120V, 50/60 HZ MODELS</b>				
<b>5PX1000RT</b>	1,000 / 1,000	5-15P	(8) 5-15R	808.33
<b>5PX1500RT</b>	1,440 / 1,440	5-15P	(8) 5-15R	1041.53
<b>5PX2200RT</b>	1,950 / 1,920	5-20P	(8) 5-20R	1599.99
<b>5PX3000RT2U</b>	3,000 / 2,700	L5-30P	(6) 5-20R (1) L5-30R	1899.99
<b>5PX3000RT3U</b>	3,000 / 2,700	L5-30P	(6) 5-20R (1) L5-30R	1999.99

For Product Information about Eaton's Line of Surge Products, Please See Page A7 in this Catalog.





**SECURITY, FIRE ALARM & SOUND CABLE (SHIELDED)**



Vendor Code: **COR**

Catalog Number	Size	Reel	Belden Number	Price per 1,000 ft.
952140609	18/2	500'	8760	126.94
952180509	18/3	500'	8770	189.99
952150509	16/2	500'	8780	195.67

**TELEPHONE CABLE CATEGORY 3 (UL LISTED)**

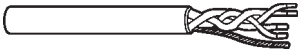

Vendor Code: **COR**

Catalog Number	Description	Belden Number	Price per 1,000 ft.
<b>TWISTED PAIR</b>			
962024609	24/2 Pair	1227A	109.99
962034609	24/3 Pair	1228A	129.99
962044609	24/4 Pair	-	133.56

**SPEAKER CABLE**

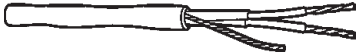

Vendor Code: **COR**

Catalog Number	Size	Color	Price per 1,000 ft.
<b>SOUNDATIONAL SUPER FLEX CABLE WITH ROUND JACKET</b>			
947644502	16/4	Yellow	429.99
947624506	16/2	Blue	249.99
947424502	14/2	Yellow	404.57
<b>CLEAR SIGNAL EXTRA FLEX SPEAKER CABLE</b>			
946624501	16/2	White	159.08

**CABLE TV COAXIAL CABLE**



Vendor Code: **COR**

Catalog Number	Wire Size	RG Type	Belden Number	Price per 1000 ft.
C0AXRG59U	22AWG	RG59U	9275	88.28
C0AXRG6U	18AWG	RG6U	9114	102.39
RG6QUAD	18AWG	RG6	1189A	126.48
RG6DUAL	2-18AWG	RG6U	N/A	194.94



NOTICE: Prices based on Comex at \$3.15 per pound, prices change weekly!

**SECURITY, FIRE ALARM & SOUND CABLE (SHIELDED)**



Vendor Code: **CBL**

Catalog Number	Size	Reel Length	Price per 1,000 ft.
BC182SLDFPLPRD1R	18/2	1,000'	89.99
BC162SLDFPLPFT16	16/2	1,000'	99.99
BC182SLDFPLPBX1R	18 AWG	1,000'	172.54
BC142SLDFPLPRD5R	14 AWG	500'	299.99

**VOICE / DATA CABLE**

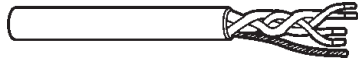

Vendor Code: **CBL**

Catalog Number	Description	Price per 1,000 ft.
<b>TWISTED PAIR - PULL OUT BOX 1,000'</b>		
BCC5EPVCWHT	White 10CAT 5E Enhanced 4 Pair 24 AWG 350 MHZ	91.99
BCC5EPVCBL	Blue 100CAT 5E Enhanced 4 Pair 24 AWG 350 MHZ	91.99
BCC5EPVCYL	Yellow 10CAT 5E Enhanced 4 Pair 24 AWG 350 MHZ	91.99
BCC6EPVCWHT	White CAT 6E Enhanced 4 Pair 23 AWG 550 MHZ	141.99
BCC6EPVCBL	Blue CAT 6E Enhanced 4 Pair 23 AWG 550 MHZ	141.99
BCC6EPVCYL	Yellow CAT 6E Enhanced 4 Pair 23 AWG 550 MHZ	141.99
<b>PLENUM</b>		
BCC5EPLWHT	CAT 5E-White 4 Pair 24 AWG 350 MHZ PLENUM	219.40
BCC5EPLBL	CAT 5E-Blue 4 Pair 24 AWG 350 MHZ PLENUM	219.40
BCC6EPLWHT01	White CAT 6-4 Pair 23 AWG 250 MHZ PLENUM	319.99
BCC6EPLBL01	Blue CAT 6-4 Pair 23 AWG 250 MHZ PLENUM	319.99
BCC6EPLWHT	CAT 6E-White 4 Pair 23 AWG 550 MHZ PLENUM	339.99
BCC6EPLBL	CAT 6E-Blue 4 Pair 23 AWG 550 MHZ PLENUM	339.99
<b>DIRECT BURIAL</b>		
BCC5DB	CAT 5E UTP 100MHZ 1,000'/REEL	144.32
BCC6DB01	CAT 6E CBL 1,000' REEL	319.58

**SPEAKER CABLE**

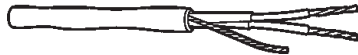

Vendor Code: **CBL**

Catalog Number	Description	Price per 1,000 ft.
BC182STSCMRGY1BX	18AWG 2C STR SHLD CMR GRY 1,000' BOX	180.47
BC183STSCMRGY1BX	18AWG 3C STR SHLD CMR GRY 1,000' BOX	323.74
BC182STRCMPWH1BX	2C 18 ST WHT	144.32





SECTION



**Tools, Terminals & Fasteners**

Tools, Terminals & Fasteners





## Tools, Terminals &amp; Fasteners

## Power Tools

Combo Kits.....	K3-K4
Hammer Drill / Driver .....	K3
Saws .....	K3, K7
Cable Cutters .....	K4
Knockouts .....	K4, K8
Batteries .....	K4
Bits.....	K5-K6
Crimpers.....	K35
Pipe Threader.....	K35
Rotary Hammer.....	K35

## Meters and Testers

Infrared Thermometer .....	K9
Electrical Testers .....	K9
Clamp Meters .....	K9, K11
Multimeters .....	K10-K11
Voltage Testers .....	K10-K11

## Hand Tools

Pliers .....	K12-K13
Cable Cutters .....	K12-K13
Crimpers .....	K13, K28-K29
Strippers .....	K13
Knives .....	K13-K14
Jab Saws .....	K14
Screwdrivers/Nut Drivers.....	K14-K15
Wrenches.....	K14
Hex Keys .....	K15
Hacksaws .....	K16
Tape Measures, Levels.....	K16
Hammers .....	K16
Pulling.....	K17
Bending .....	K18
Tool Bags, Phone Holders .....	K19
Gloves.....	K20
Flashlights, Batteries .....	K20
Ladders.....	K21
Shovels .....	K21
Safety .....	K22
Caulk.....	K23
Fire Protection .....	K23
Wire Marking.....	K30
Label Printers.....	K34
Tool Boxes.....	K36

## Fasteners

Tape.....	K24-K25
Underground Splice .....	K24
Heat Shrink.....	K25
Wire Connectors .....	K25, K27
Lockout / Tagout.....	K25
Lugs .....	K26, K28
Multi-tap Connectors.....	K27
Splices .....	K28-K29
Cable Ties.....	K30
Screws, Bolts, Nuts, Anchors.....	K31-K33
Jack Chain.....	K31





## M18™ Cordless Tools (1/2" Hammer Drill/Driver · Reciprocating Saws)

### M18™ CORDLESS LITHIUM-ION 4-TOOL COMBO KIT

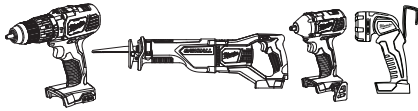

The 269624 M18™ Cordless 4-Tool Combo Kit includes the M18™ 1/2" Hammer Drill/Driver (260220), M18™ Sawzall® Reciprocating Saw (262020), M18™ 1/4" Hex Impact Driver (265020), and M18™ Work Light (49240171). The M18™ Cordless LITHIUM-ION System's patented technologies and electronics, innovative motor design, and superior ergonomics provide the most efficient blend of power, weight and performance in the industry. Powered by RED LITHIUM™ the M18™ cordless system delivers more torque, more power, and longer run-time than the competition.

Vendor Code: **MIL**

Catalog Number	Description	Price Each
<b>262020</b>	M18™ Sawzall® Recip Saw (Tool Only)	129.99
<b>265020</b>	M18™ 1/4" Hex Impact Driver (Tool Only)	109.99
<b>269624</b>	M18™ Cordless Lithium-Ion Four Tool Combo Kit	548.96

Kit Includes: M18™ 1/2" Hammer Drill Driver, SAWZALL® M18™ Reciprocating Saw, M18™ 1/4" Hex Impact Driver, M18™ Work Light, Two M18™ XC High Capacity RED LITHIUM™ Batteries, 1-Hour Charger, General Purpose SAWZALL® Blade and a Contractor Bag



### M18 FUEL™ 1/2" HAMMER DRILL/DRIVER

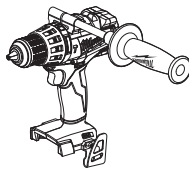

- POWERSTATE™ Brushless Motor: Purposely built for the M18 FUEL™ 1/2" Hammer Drill to provide Up To 60% More Power than the competitive set
- REDLITHIUM™ XC5.0 Battery Pack: Delivers more work per charge and more work over the life of the pack than competitors
- Only 6.9" in length for access into tight spaces and reduced fatigue
- Compatible with all M18™ batteries
- Up To 60% More Power: 1,200 in-lbs of torque
- LED on foot of tool for better lighting in dark spaces

Vendor Code: **MIL**

Catalog Number	Description	Price Each
<b>280420</b>	M18 FUEL™ 1/2" Hammer Drill/Driver (Tool Only)	174.29
<b>280422</b>	M18 FUEL™ 1/2" Hammer Drill Kit	352.00

Kit Includes: One M18 FUEL™ 1/2" Hammer Drill/Driver (280420), Two M18 REDLITHIUM XC 5.0 Battery Packs (48111850), One M18/M12 Multi-Voltage Rapid Charger (48591812), a Side Handle, Belt Clip, Belt Holder, and a Durable Carrying Case.

### M12™ CORDLESS SUB COMPACT BAND SAW

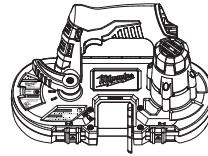

The M12™ Sub-Compact Band Saw is the most compact and lightest weight cordless band saw on the market. At less than half the weight and size compared to a traditional deep cut band saw, the M12™ Band Saw provides one-handed power and portability to electricians, maintenance professionals, and other users cutting small diameter materials. The M12™ Band Saw weighs only 6.75 lbs and 12" in length, making it ideal for overhead or one-handed cutting applications.

Vendor Code: **MIL**

Catalog Number	Description	Price Each
<b>242920</b>	Sub-Compact Band Saw (Tool Only)	169.59
<b>242921XC</b>	Sub-Compact Band Saw Kit	261.46

Kit Includes: 18 TPI Sub-Compact Band Saw Blade, M12™ Sub-Compact Band Saw, M12™ XC High Capacity REDLITHIUM™ Battery, M12™ Lithium-Ion Battery Charger, and a Carrying Case

### M18 FUEL™ SAWZALL® RECIPROCATING SAWS

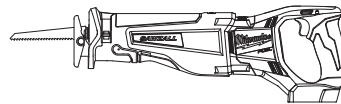

The M18 FUEL™ SAWZALL® Reciprocating Saw cuts faster than its corded counterparts and offers up to 2X more runtime and 5X longer tool life than competitive saws. The POWERSTATE™ brushless motor provides cutting power that has only been associated with corded tools. The M18™ REDLITHIUM™ XC5.0 Extended Capacity Battery Pack (not included) delivers up to 2.5X runtime and provides more work per charge and more work over the life of the pack than competitive batteries. The saw's REDLINK PLUS™ Intelligence ensures optimized performance and protection from overloading, overheating and over-discharging.

Vendor Code: **MIL**

Catalog Number	Description	Price Each
<b>272020</b>	Reciprocating Saw (Tool Only)	223.94
<b>272022</b>	Reciprocating Saw Kit	481.08

Kit Includes: M18 FUEL™ SAWZALL® Reciprocating Saw, M18™ and M12™ Multi-Voltage Charger, Two M18™ REDLITHIUM™ XC5.0 Extended Capacity Battery Packs, Blade, and a Carrying Case

Tools, Terminals & Fasteners





M12™ 600 MCM CABLE CUTTERS



Vendor Code: MIL

Catalog Number	Description	Price Each
247220	M12™ 600 MCM Cable Cutter (Tool Only)	390.12
247221XC	M12™ 600 MCM Cable Cutter Kit	531.93

Kit Includes: Cable Cutter, M12™ XC High Capacity REDLITHIUM™ Battery, M18™ and M12™ Multi-Voltage Charger and a Carrying Case



M18 FUEL™ 2-TOOL COMBO KIT

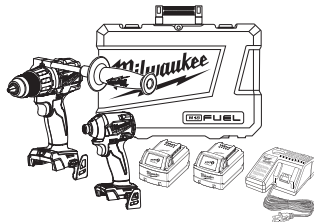

280420

The M18 FUEL™ ½" Hammer Drill is the Industry's Most Powerful Drill by delivering Up to 60% More Power, Up To 1.5' Shorter length and Up To 2X Faster Speed Under Heavy Load.

285320

The M18 FUEL™ ¼" Hex Impact Driver's POWERSTATE™ Brushless motor delivers up to 2,000in-lbs of torque and up to 30% Faster Driving speed, increasing user's productivity for the most demanding fasteners on the job.

Vendor Code: MIL

Catalog Number	Description	Price Each
299722	M18 FUEL™ 2-Tool Combo Kit: Hammer Drill/Impact	468.33

Kit Includes: One M18 FUEL™ ½" Hammer Drill/Driver (280420), One M18 FUEL™ ¼" Hex Impact Driver (285320), Two M18™ REDLITHIUM™ XC5.0 Extended Capacity Battery Packs (48111850), One M18™ and M12™ Multi-Voltage Charger (48591812), One Carrying Case, One Side Handle, Two Belt Clips, Two Bit Holders

M18 FUEL™ HOLE HAWG®  
RIGHT ANGLE DRILL KIT W/QUIK-LOK™

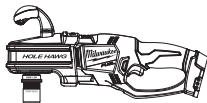

Vendor Code: MIL

Catalog Number	Description	Price Each
270820	Right Angle Drill Kit (Tool Only)	265.33
270822	Right Angle Drill Kit	523.29

Kit Includes M18 FUEL™ HOLE HAWG® Right Angle Drill w/QUIK-LOK™, Two M18™ REDLITHIUM™ XC5.0 Extended Capacity Battery Packs, M18™ & M12™ Multi-Voltage Charger, and a Contractor's Bag

M18™ FORCE LOGIC™ KNOCKOUT TOOL

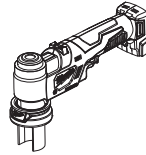

- Force Logic™ punches up to 4"
- Compatible with all major brands of Punches and Dies
- Powerful hydraulic system
- Light compact design
- M12™ and M18™ multi voltage charger
- M18™ REDLITHIUM™ extended capacity battery pack

Vendor Code: MIL

Catalog Number	Description	Price Each
267720*	6 Ton Knockout (Tool Only)	963.93
267721	6 Ton Knockout Tool 1/2" - 2" Kit	1108.22
267723	6 Ton Knockout Tool 1/2" - 4" Kit	1552.14
267620*	10 Ton Knockout (Tool Only)	1436.99
267622	10 Ton Knockout Tool 1/2" to 2" Kit	1696.53
267623	10 Ton Knockout Tool 1/2" to 4" Kit	2141.43

Kits Include: Punches and Dies, Charger, and Case  
\*Tools Include: Battery, Charger, and Case

18V BATTERY AND CHARGER



48111850



48591807



48591812

48111850

- Offers long-lasting performance and durability
- Powers more than 60 Milwaukee® M18™ cordless power tools

48591807

- Charges Three Batteries Simultaneously
- Charges Each Battery up to 40% Faster
- Accepts up to Three M18™ and Three M12™ Battery Packs

48591812

- Accepts all M18™ and all M12™ Battery Packs, minimizing the need for extra chargers on the jobsite.
- The Combo Charger charges batteries sequentially, utilizing a first in, first charged sequence.

Vendor Code: MIL

Catalog Number	Description	Price Each
48111850	M18™ REDLITHIUM™ XC5.0 Extended Capacity Battery Pack	148.61
48591807	M18™ and M12™ Rapid Charge Station	233.40
48591812	M18™ and M12™ Multi-Voltage Charger	69.99





**NEW**

## SCREWDRIVER BIT SETS SHOCKWAVE IMPACT DUTY™

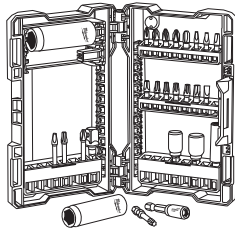

48324408

26 Piece Shockwave Drive and Fasten Bit Set Includes:

Phillips Bit 1" P1, Phillips Bit 1" P2, Three Phillips Bits 1" P3, Square Bit 1" SQ1, Two Square Bits 1" SQ2, Square Bit 1" SQ3, Two TORX® Bits 1" T20, Two TORX® Bits 1" T25, TORX® Bit 1" T30, 1/4" Hex - 3/8" Square Adapter, 1/4" Magnetic Nut Driver, Phillips Bit 2" P2, Square Bit 2" SQ2, TORX® Bit 2" T20, TORX® Bit 2" T25, Slotted Bit 1" SL 3/16", 3/8" Drive: 1/2" Socket, 3/8" Drive: 9/16" Socket, 3/8" Magnetic Nut Driver, 5/16" Magnetic Nut Driver, Shockwave™ Compact Magnetic Bit Holder, and a Hard Case

40 Piece Shockwave™ Drill & Drive Set Includes:

1" #1 Phillips Bit, Four 1" #2 Phillips Bits, Two 2" #2 Phillips Bits, 1" #2R Phillips Bit, 1" #3 Phillips Bit, 2" #3 Phillips Bit, 1" #1 Square Bit, Two 1" #2 Square Bits, 2" #2 Square Bit, 1" #3 Square Bit, 2" #3 Square Bit, 1" T15 Torx Bit, 1" T20 Torx Bits, 2" T20 Torx Bits, Two 1" T25 Torx Bits, 2" T25 Torx Bits, 1" #8 Slotted Bit, 1" #10 Slotted Bit, 2" #10 Slotted Bit, 1" 1/8" Hex Bit, 1" 5/32" Hex Bit, 1" 3/16" Hex Bit, 1" 1/4" Hex Bit, 1/8" Hex Drill Bit, 3/16" Hex Drill Bit, 1/4" Hex Drill Bit, 1/4" x 1-7/8" Nut Driver, 5/16" x 1-7/8" Nut Driver, 3/8" x 1-7/8" Nut Driver, 1/4" - 3/8" Square Adapter, 1/4" - 1/2" Square Adapter, Compact Bit Holder and a Case

Vendor Code: **MIL**

Catalog Number	Description	Price Each
48324408	26 Piece Shockwave™ Drive and Fasten Set	24.98
48324006	40 Piece Shockwave™ Drill & Drive Set	27.97

## MAGNETIC NUT DRIVERS SHOCKWAVE IMPACT DUTY™

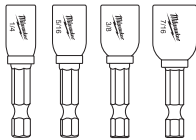

49664562

- Chamfered Edge for better fit and reduced rounding
- Color Coded Band for easy identification

Vendor Code: **MIL**

Catalog Number	Hex Size	Length	Price Each
49664502	1/4"	1-7/8"	2.66
49664503	5/16"	1-7/8"	2.98
49664532	1/4"	2-9/16"	3.19
49664533	5/16"	2-9/16"	3.64
49664535	3/8"	2-9/16"	3.98
<b>4 PIECE NUT DRIVERS SET</b>			
49664562	1/4", 5/16", 3/8", 7/16"	1-7/8"	14.47

Color Identification Band	Hex Size
Red	1/4"
Amber	5/16"
Blue	3/8"
Brown	7/16"

## SCREWDRIVER BITS



Vendor Code: **MIL**

Catalog Number	Description	Price Each
48324602	(5) #2 Phillips Shockwave™ 2" Power Bits	7.78

## SOCKET ADAPTOR

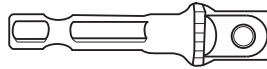

- Proprietary steel and heat treat process for maximum strength and durability
- Heavy duty construction for fastening capabilities in all impacts

Vendor Code: **MIL**

Catalog Number	Description	Price Each
48325031	1/4" Hex Shank to 3/8" Socket Adaptor	3.71

## MAGNETIC DRIVE GUIDE

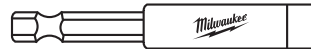

- Expandable sleeve for fast, straight driving
- 2-piece construction withstands abuse in impact applications
- Proprietary steel and heat treat process for maximum strength and durability
- Strong magnetic tip for secure grip

Vendor Code: **MIL**

Catalog Number	Description	Price Each
48324508	Shockwave™ 3" Magnetic Drive Guide	6.16

Tools, Terminals & Fasteners





**NEW**

**DRILL BIT SETS  
BLACK OXIDE COATING**



48892802

These Drill Bit Sets offer convenience and heavy-duty performance on the jobsite. Milwaukee Black Oxide drill bits are designed for extreme durability and long life. The web features a thicker core than a standard drill bit to provide ultimate strength and protect against side-load breakage. A specially designed parabolic flute form clears chips and debris fast to keep the bit cool. A precision start, 135 Split Point tip starts on contact to keep the bit from walking for fast accurate holes. Excellent for drilling on curved surfaces, requires less effort to drill and is highly recommended for use with portable drills. The 3-Flat Secure-Grip shank won't slip in the drill chuck. Reduced shank diameter for use in 3/8" chucks.

**48892803**

The set comes in a resilient case and includes bit sizes 1/16", 5/64", 3/32", 7/64", 1/8", 9/64", 5/32", 11/64", 3/16", 13/64", 7/32", 1/4", 9/32", 5/16", and 3/8".

**48892801**

The set comes in a resilient case and includes bit sizes (2) 1/16", (2)5/64", 3/32", 7/64", (2) 1/8", 9/64", 5/32", 11/64", (2) 3/16", 13/64", 7/32", 15/64", (2) 1/4", 5/16", 3/8", and 1/2".

**48892802**

The set comes in a resilient case and includes the following bit sizes: 1/16", 5/64", 3/32", 7/64", 1/8", 9/64", 5/32", 11/64", 3/16", 13/64", 7/32", 15/64", 1/4", 17/64", 9/32", 19/64", 5/16", 21/64", 11/32", 23/64", 3/8", 25/64", 13/32", 27/64", 7/16", 29/64", 15/32", 31/64", and 1/2".

Vendor Code: MIL

Catalog Number	Description	Price Each
48892803	15 Piece Black Oxide Drill Bit Set	25.99
48892801	THUNDERBOLT® 21 Piece Black Oxide Drill Bit Set	29.99
48892802	29 Piece Black Oxide Drill Bit Set	67.99

**STEP DRILL BITS**



48899201

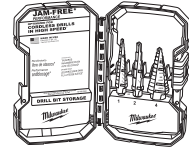

48899221

Vendor Code: MIL

Catalog Number	Uni-Bit	No. of Sizes	Hole Sizes	Price Each
48899201	#1	13	1/8" - 1/2"	25.96
48899203	#3	9	1/4" - 3/4"	45.58
48899204	#4	12	3/16" - 7/8"	50.38
48899205	#5	10	1/4" - 1-3/8"	98.29
48899208	#8	9	1/2" - 1"	52.74
48899209	#9	2	7/8" & 1-1/8"	65.57
48899212	#12	5	7/8" - 1-3/8"	78.63

**3 PIECE STEP DRILL BIT SET**

Catalog Number	Description	Price Each
48899221	3 Piece Kit Includes: #1 Step Drill Bit (1/8" - 1/2" by 1/32"), #2 Step Drill Bit (3/16" - 1/2" by 1/16"), #4 Step Drill Bit (3/16" - 7/8" by 1/16"), and a Carrying Case	98.28

**SHIP AUGER BITS**



Vendor Code: MIL

Catalog Number	Hole Diameter	Price Each
<b>18" LENGTH</b>		
48135750	3/4"	34.91
48135870	7/8"	38.77
48135930	15/16"	44.58
48136000	1"	41.37
48136120	1-1/8"	59.48
48136250	1-1/4"	67.87

**HAMMER DRILL BITS**



Vendor Code: MIL

Catalog Number	Diameter	Bit Length	Flute Length	Price Each
48208805*	3/16"	4"	2"	6.18
48208810	1/4"	4"	2"	3.10
48208811	1/4"	6"	4"	3.62
48208821	3/8"	6"	4"	5.67
48208830	1/2"	6"	4"	8.26

\*Two Pack

Tools, Terminals & Fasteners

K





## BI-METAL HOLE SAWS



Vendor Code: MIL

Catalog Number	Diameter	Pipe Entrance	Price Each
<b>SUITABLE FOR WOOD, METAL, OR PLASTIC</b>			
49560023	3/4"	3/8"	8.54
49560032	7/8"	1/2"	8.67
49560052	1-1/8"	3/4"	9.09
49560072	1-3/8"	1"	9.31
49560102	1-3/4"	1-1/4"	10.13
49560117	2"	1-1/2"	10.47
49560147	2-1/2"	2"	12.41
49560173	3"	2-1/2"	12.85
49560197	3-5/8"	3"	13.92
49560217	4-1/8"	3-1/2"	20.34
49560233	4-1/2"	4"	35.32
49560027	13/16" Hole Saw		8.54
49560043	1" Hole Saw		9.09
49560305	6-3/8" for Recessed Light		39.31
<b>HOLE SAW KIT</b>			
49224095	10 Piece Kit: 7/8" - 2 1/2"		82.79

## HOLE SAW ARBORS AND PILOT BITS

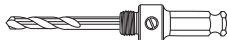

Vendor Code: MIL

Catalog Number	Shank Size	Shank Type	Drill Chuck Size	Price Each
<b>HOLE SAW ARBORS - FOR HOLE SAWS UP TO 1-3/16" IN DIAMETER</b>				
49567010	3/8"	Hex	3/8"	10.19
49567000	7/16"	Hex	1/2"	10.98
<b>HOLE SAW ARBORS - FOR HOLE SAWS 1-1/4" AND LARGER</b>				
49567250	3/8"	Hex		21.97
<b>PILOT BITS</b>				
49568010	1/4" x 3-1/2"			4.38
49568000	1/4" x 4"			4.66



## IMPACT HOLE SAWS SHOCKWAVE™

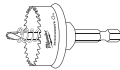

Vendor Code: MIL

Catalog Number	Description	Price Each
49224800*	3 Piece Kit Thin Wall Hole Saw	36.18
49569805	3/4" Thin Wall Hole Saw	12.69
49569810	7/8" Thin Wall Hole Saw	13.07
49569815	1" Thin Wall Hole Saw	13.19
49569820	1-1/8" Thin Wall Hole Saw	14.47
49569825	1-1/4" Thin Wall Hole Saw	15.32
49569830	1-3/8" Thin Wall Hole Saw	15.40
49569835	1-1/2" Thin Wall Hole Saw	15.53

\*Includes Sizes: 7/8", 1-1/8", and 1-3/8"

## BI-METAL RECIPROCATING SAW BLADES



Standard Bi-Metal Reciprocating Saw Blades - Thin Kerf



Sawzall® Saw Blades - The Wrecker

Vendor Code: MIL

Catalog Number	Description	Price Each
<b>METAL</b>		
48005201	The TORCH™ with CARBIDE TEETH 7T 6L 1PK	12.99
48005202	The TORCH™ with CARBIDE TEETH 7T 9L 1PK	16.99
48005788	SAWZALL® BL 18T 9LG TORCH 5PK	23.78
48005786	SAWZALL® BL 24T 6LG TORCH 5PK	13.30
48005184	SAWZALL® BL 18T 6LG METAL THIN KERF 5PK	15.50
<b>WOOD</b>		
48005221	THE AX™ with CARBIDE TEETH 5T 6L 1PK	9.99
48005226	THE AX™ with CARBIDE TEETH 5T 9L 1PK	12.99
48005021	SAWZALL® BL 5T 6LG AX 5PK	17.94
48005026	SAWZALL® BL 5T 9LG AX 5PK	24.82
48005037	SAWZALL® BL 5T 12LG WOOD THIN KERF 5PK	26.89
<b>MULTI-MATERIAL</b>		
48005701	SAWZALL® BL 7/11T 6LG WRECKER 5PK	15.99
48005706	SAWZALL® BL 7/11T 9LG WRECKER 5PK	20.99
48005711	SAWZALL® BL 7/11T 12LG WRECKER 5PK	20.10
48005193	SAWZALL® BL 10/14T 8LG MM THIN KERF 5PK	18.32
48005194	SAWZALL® BL 10/14T 12LG MM THIN KERF 5PK	21.43

## PORTABLE BAND SAW BLADES



Vendor Code: MIL

Catalog Number	Size	Teeth per Inch	Price Each
<b>STANDARD BI-METAL RECIPS .035 THICK</b>			
48390510	6	10	9.31
48390520	6	14	9.31
48390530	6	18	9.31

## PORTABLE HACK SAW BLADES

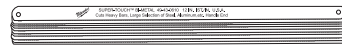

Vendor Code: MIL

Catalog Number	Size	Teeth per Inch	Price Each
<b>HACKSAW BLADES</b>			
48430610	12 x 1/2"	18	18.69
48430620	12 x 1/2"	24	18.69
48430630	12 x 1/2"	32	18.69

All Hacksaw Blades Sold in Ten Packs.



Tools, Terminals & Fasteners



**EXACT™ KNOCK-OUT PUNCHES AND DIES**

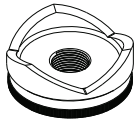

Punch



Die

EXACT™ punches and dies have innovative features which bring value for the contractor. Heavy duty, they can punch holes in both mild and stainless steel material. Engraved crosshairs on the dies deliver clearest alignment with pre-drawn crosshairs. Both the tooth geometry of the punches, and slug removal ports on the dies, provide optimal slug removal. Large size ID markings on both the punches and dies permit easy punch and die selection. EXACT™ punches and dies do not require spacers.

Vendor Code: MIL

Catalog Number	Description	Price Each
<b>PUNCHES</b>		
49162661	1/2" Mild Steel Punch	29.17
49162661S	1/2" Stainless Steel Punch	29.17
49162663	3/4" Punch	35.83
49162665	1" Punch	45.00
49162667	1-1/4" Punch	57.08
49162669	1-1/2" Punch	72.50
49162671	2" Punch	88.85
49162673	2-1/2" Punch	105.00
49162675	3" Punch	156.43
49162677	3-1/2" Punch	203.57
49162679	4" Punch	242.86
<b>DIES</b>		
49162660*	1/2" Mild Steel Die	18.33
49162660S	1/2" Stainless Steel Die	18.33
49162662	3/4" Die	22.08
49162664	1" Die	28.33
49162666	1-1/4" Die	35.83
49162668	1-1/2" Die	45.00
49162670	2" Die	63.33
49162672	2-1/2" Die	78.85
49162674	3" Die	109.23
49162676	3-1/2" Die	164.29
49162678	4" Die	203.57



**INKZALL® MARKER**



INKZALL Jobsite Markers feature clog resistant tips and the ability to write through dusty, wet or oily surfaces. The durable marker tips are designed for writing on rough surfaces such as OSB, cinder block and concrete and the ink dries quickly to reduce smearing markings, without drying out quickly when the cap is left off. For added user convenience, the INKZALL markers have a built-in hard hat clip for easy storage and access.

Vendor Code: MIL

Catalog Number	Description	Price Each
48223100	INKZALL Black Fine Point Marker	1.39
48223104	INKZALL Black Fine Point Marker (Four Pack)	5.43

**DRAW STUDS EXACT™**

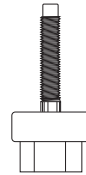

- Draw stud's flat end designed to guide punch on for faster thread engagement.

Vendor Code: MIL

Catalog Number	Description	Price Each
49162621	3/8" Ball Bearing Draw Stud	35.00
49162622	3/4" Ball Bearing Draw Stud	35.00
49162680	7/16" Draw Stud	35.00
49162681	3/4" Draw Stud	35.00
49162682	1-1/8" Draw Stud	35.00



**PUNCH AND DIE SETS EXACT™**



Vendor Code: MIL

Catalog Number	Description	Price Each
49162692*	1/2" to 1-1/4" Knockout Set	229.87
49162695**	2-1/2" to 4" Knockout Set	849.97

\*Set includes: 3/8" Ball Bearing Draw Stud, 3/4" Ball Bearing Draw Stud, 1/2" Mild Steel Die, 1/2" Mild Steel Punch, 3/4" Die, 3/4" Punch, 1" Die, Punch, 1-1/4" Die, 1-1/4" Punch, and a Carrying Case

\*\*Set includes: 2-1/2" Die, 2-1/2" Punch, 3" Die, 3" Punch, 3-1/2" Die, 3-1/2" Punch, 4" Die, 4" Punch, 1-1/8" Draw Stud, and a Carrying Case

**ADAPTORS**

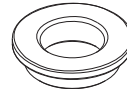

Vendor Code: MIL

Catalog Number	Description	Price Each
49162684	Adaptor for EXACT™ 2-1/2" to 4" Punches and Dies	17.98
49162685	Adaptor for Other Major Brands of Punches and Dies	17.98



Tools, Terminals & Fasteners

K



## Fluke Offers Designs for Everyday Use

Fluke meters and testers are designed to help you do your job faster, more efficiently and with greater accuracy, there is a model for every budget and application.

### Infrared Thermometers

Infrared Thermometers are non-contact meters that allow you to find hotspots, locate grounds in circuits, spot energy loss sources, measure temperature from a safe distance or locate wire damage. Their applications are endless and they are an essential tool in today's electrical testing world.

### Digital Multimeters

Fluke digital multimeters are built to troubleshoot and repair electrical, electronic and HVAC systems. Professional technicians rely on these professional meters because of their high degree of accuracy and durability. Find a wide selection of these meters to fit your application.

### Clamp Meters

Fluke Clamp Meters allow plant maintenance and electrical professionals to take reliable readings in tight compact spaces. Used in commercial and residential applications, these meters can perform in the toughest environments while you diagnose and troubleshoot electrical problems.

### Insulation Testers

Keep your power systems running smoothly with Fluke insulation testers. Electrical construction and maintenance professionals can use these testers to troubleshoot and add to their preventive maintenance program.

### INFRARED THERMOMETER



Vendor Code: **FLU**

Catalog Number	Description	Price Each
<b>62MAX</b>	Measures -22°F to 932°F	116.54

### ELECTRICAL TESTERS, CONTINUITY TESTERS AND VOLTAGE DETECTORS



Vendor Code: **FLU**

Catalog Number	Volts	Amps	Ohms	Price Each
<b>ELECTRICAL TESTER WITH OPENJAW™ CURRENT</b>				
<b>T5600</b>	600	100	1,000	136.92
<b>T51000USA</b>	1,000	100	1,000	181.47
<b>T6600</b>	600	200	2,000	214.27
<b>T61000</b>	1,000	200	20,000	299.99

### TRUE-RMS CLAMP METERS 320 SERIES



Vendor Code: **FLU**

Catalog Number	Volts	Amps	Price Each
<b>323</b>	600	400	152.01
<b>324</b>	600	400	222.96

### 370 SERIES



Vendor Code: **FLU**

Catalog Number	Volts	Amps	Price Each
<b>373</b>	600	600	253.36
<b>374FC</b>	1,000	600	385.12
<b>375FC</b>	1,000	1,000	435.80
<b>376FC*</b>	1,000	1,000	486.47

\*Includes iFlex™ Flexible Current Clamp





**ELECTRICIAN'S DIGITAL MULTIMETER WITH NON-CONTACT VOLTAGE**



- True RMS
- AutoVolt automatic AC/DC voltage selection
- LoZ: helps prevent false readings due to ghost voltage
- Large display with LED backlight to work in poorly lit areas
- Min/Max/Average to record signal fluctuations
- Resistance, continuity, frequency and capacitance

Vendor Code: **FLU**

Catalog Number	Description	Price Each
117	600V, V-O-A Multimeter with Holster and Test Leads	222.96

**DIGITAL MULTIMETER 87-5**



- Unique function for accurate voltage and frequency measurements on adjustable speed motor drives and other electrically noisy equipment
- Built-in thermometer conveniently allows you to take temperature readings without having to carry a separate instrument
- Optional magnetic hanger for easy set-up and viewing while freeing your hands for other tasks
- Large digit display with bright, two-level backlight makes the 87-5 significantly easier to read than older models

Vendor Code: **FLU**

Catalog Number	Description	Price Each
875	True RMS Digital Multimeter	445.93



**NEW PROCESSMETER™**



- Very large dual display
- Enhanced backlight with 2 brightness settings
- 1200 ohm drive capability on mA source
- HART mode setting with loop power and a built-in 250 ohm resistor
- 4-20mA loop calibration
- 0% and 100% buttons to toggle between 4 and 20 mA sourcing for a quick span check
- Infrared-port to process data in FlukeView Forms (V2.1) software

Vendor Code: **FLU**

Catalog Number	Description	Price Each
789	24V Loop Power Supply	1064.18

**ADVANCED ELECTRICAL TROUBLESHOOTING KIT**

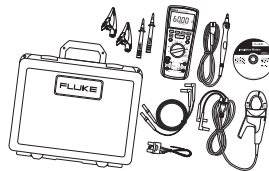

The products in this kit have been specifically selected for both troubleshooting and preventative maintenance applications. The kit includes a Fluke 1587 FC 2-in-1 Insulation DMM, Fluke 1400 Current Clamp, and a Fluke 62 Max+ Infrared Thermometer.

- With the Fluke 1587 FC, perform insulation tests, plus a wide-range of DMM tasks with confidence and ease
- Use the Fluke 1400 with your Fluke 1587 FC to accurately measure AC current without breaking the circuit
- The Fluke 62 MAX+ Infrared Thermometer measure -30°C to 650°C (-22°F to 1202°F), is extremely accurate, and has an IP54 rating for water resistance and dust proof

Vendor Code: **FLU**

Catalog Number	Description	Price Each
1587KIT62MAXFC	Maintenance Kit	1249.98

**VOLTALERT**



- Fits in a shirt pocket for convenience
- All outer surfaces are non-conductive for safety
- Detects voltage without metallic contact
- Quickly locates the hot, neutral and ground terminals in any receptacle

Vendor Code: **FLU**

Catalog Number	Description	Price Each
1ACA111	Voltage Detector	32.98

**METER CASES AND ACCESSORIES**



TP1



TL75



TL220



AC175



AC220



C25



H5



HT6

Vendor Code: **FLU**

Catalog Number	Description	Price Each
<b>TEST LEADS</b>		
TP1	Flat Blade Test Probes	22.28
TL175	Twist Cover Probe Set	35.46
TL75	Test Lead Set	28.36
TL224	Silicon Test Lead Set	33.43
TL220	Industrial Test Lead Set	86.14
AC175	Alligator Clip Set	33.43
AC220	Suregrip Alligator Clips	50.66
<b>CASES</b>		
C25	Soft Case for H Series and 80 Series	45.59
C50	Compact Soft Case for 20, 50 and 70 Series	46.61
H5	Custom Holder for T5 Series	39.51
HT6	Custom Holder for T6 Series	39.51

Tools, Terminals & Fasteners

K





## DIGITAL CLAMP METERS



CL380



CL800

The CL380 is an automatically ranging true-root mean square (TRMS) digital clamp meter that measures AC/DC current via the clamp, AC/DC voltage, DC microamps, resistance, continuity, frequency, capacitance, tests diodes via test-leads, and temperature via a thermocouple probe.

The CL800 is a digital clamp meter with automatically ranging true mean squared (TRMS) technology for increased accuracy. The CL800 includes carrying pouch, test leads, thermocouple with adapter and batteries.

Vendor Code: **KLE**

Catalog Number	Description	Price Each
CL380	Auto-Ranging, 600V	85.70
CL800	Auto-Ranging, 1,000V	152.98



## BORESCOPE WITH WIFI



- WiFi Borescope transmits and displays video and images directly to your smartphone up to 30 Feet away.
- Waterproof 9 mm camera has six on-board, adjustable LED lights and outputs high-quality 640 x 480 images.
- The Klein Borescope App is available free at the App Store® for iPhone® users and Google Play® for Android® users.

Vendor Code: **KLE**

Catalog Number	Description	Price Each
ET20	WiFi Borescope	95.27



## DIGITAL MULTIMETERS



MM600



MM700

The MM600 is an auto-ranging digital multimeter that measures AC/DC voltage, 10 Amp AC/DC current, and resistance. It also measures temperature, capacitance, frequency, duty-cycle, and tests diodes and continuity.

The MM700 is an auto-ranging True Root-Mean-Squared (TRMS) digital multimeter that measures AC/DC voltage, 10 Amp AC/DC current, and resistance. It also measures temperature, capacitance, frequency, duty-cycle, and tests diodes and continuity.

Vendor Code: **KLE**

Catalog Number	Description	Price Each
MM400	Auto-Ranging, 600V	59.99
MM600	Auto-Ranging, 1,000V	90.46
MM700	TRMS/Low Impedance	120.82

## NON-CONTACT VOLTAGE TESTERS



NCVT2



NCVT3

The dual-range NCVT-2 detects low voltage (12-48V AC) in addition to standard voltage, and is perfect for use in security, entertainment, communications, environmental control and irrigation systems.

The NCVT-3 detects 12-1000V AC and includes a bright LED flashlight that illuminates dark or dimly-lit work areas. The NCVT-3 is rated IP67: dustproof/waterproof and can withstand a 6.6 foot drop.

Vendor Code: **KLE**

Catalog Number	Description	Price Each
NCVT2*	Dual Range, Non-Contact Voltage Tester	24.99
NCVT3**	Non-Contact Voltage Tester Flashlight	29.99

\*Voltage Range: 48 - 1,000

\*\*Voltage Range: 12 - 1,000V AC

## CIRCUIT TRACERS

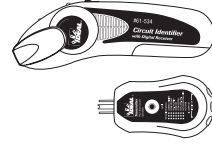

- Indicates the right breaker
- Works on 120/240V circuits
- Verifies presence of power and proper wiring

Vendor Code: **IDE** (Ideal)

Catalog Number	Description	Price Each
61534	Digital Breaker Finder with GFCI Receptacle Tester	110.82



Vendor Code: **KLE** (Klein Tools)

Catalog Number	Description	Price Each
ET310	Digital Circuit Breaker Finder with GFCI Outlet Tester	52.49

## RECEPTACLE TESTERS



RT110



RT210

- Light sequence indicates correct/incorrect wiring
- Designed to detect the most common wiring problems in standard receptacles

Vendor Code: **KLE**

Catalog Number	Description	Price Each
RT110	Receptacle Tester	6.82
RT210	GFCI Receptacle Tester	12.99

## 3 PHASE MOTOR ROTATION TESTER



Vendor Code: **IDE**

Catalog Number	Description	Price Each
61521	Phase Tester	191.81

Tools, Terminals & Fasteners





**PLIERS**  
9" SIDE-CUTTING



"D" Series



Journeyman Series

Vendor Code: **KLE**

Catalog Number	Description	Price Each
<b>"D" SERIES</b>		
D2139NE	Dipped Handles	35.47
HD20009NE	High Leverage ACSR Rated	48.39
<b>JOURNEYMAN SERIES</b>		
J2139NE	9" Pliers Side Cutting	43.94
J20009NE	9" Pliers Heavy Duty Side Cutting	48.85
J2139NECRN	Side Cutters with Wire Stripper/Crimper	56.29

**PLIERS**  
LONG-NOSE SIDE-CUTTING



Vendor Code: **KLE**

Catalog Number	Description	Price Each
<b>OVERALL LENGTH 8-1/2"</b>		
D2038N	Dipped Handle	34.78
J2038N	Journeyman, Cut & Strip	41.71
<b>OVERALL LENGTH 8-5/8"</b>		
J2078CR	All-Purpose Pliers with Crimper	49.95

**CABLE CUTTERS**



Vendor Code: **KLE**

Catalog Number	Description	Price Each
<b>HIGH-LEVERAGE DESIGN</b>		
J63050	Journeyman, 9-9/16" Length	40.76
63050	9-1/2" Length	34.71



**PLIERS**  
DIAGONAL CUTTING



Journeyman Series

- High-leverage design
- Rivet is closer to the cutting edge for 36% greater cutting and gripping power than other plier designs
- Short jaws and bevelled cutting edges permit close cutting of wire
- Induction-hardened cutting knives for long life

Vendor Code: **KLE**

Catalog Number	Description	Price Each
<b>OVERALL LENGTH 8"</b>		
D2288	Dipped Handles	30.56
J2288*	Cushion Grip	36.65
J200028*	ACSR** Rated	43.94
<b>OVERALL LENGTH 8" WITH ANGLED HEAD</b>		
D2488	Dipped Handles	31.19
J2488*	Cushion Grip	37.81
J200048*	ACSR** Rated	44.79

\*Journeyman Series  
\*\*Aluminum Conductor Steel Reinforced

**CABLE CUTTER**  
RATCHETING

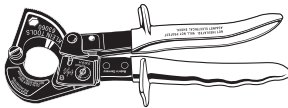

- Cleanly cuts copper up to 400 MCM, as well as aluminum and multi-conductor cables up to 600 MCM.
- Compact, lightweight tool can be locked in closed position for pouch carrying.

Vendor Code: **KLE**

Catalog Number	Description	Price Each
63060*	Ratcheting Cable Cutter	249.99

\*Not Designed for Cutting Steel or Aluminum Conductor Steel Reinforced Cable (ACSR).

**"KLEIN-KOAT"**  
TENITE HANDLES FOR PLIERS



Vendor Code: **KLE**

Catalog Number	Description	Price Each
70	For 7" Pliers	9.99
89	For 8" or 9" Pliers	10.99

**CABLE CUTTERS**  
STANDARD



- Shear-type cutting blades, drop-forged steel jaws with black oxide finish are replaceable if damaged or worn out
- Strong fiberglass handles with heavy vinyl grips for comfort and slip resistance

Vendor Code: **KLE**

Catalog Number	Description	Price Each
63041	500 MCM Cu / 750 MCM AL	158.04

**HI-VISIBILITY TOOLS**



D20009NEGLW

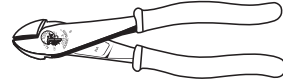

D20028GLW

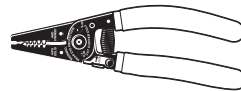

11054GLW

- Grips glow in the dark to help find your tools
- Grips charge in natural and artificial lighting
- Glow lasts up to 30 minutes

Vendor Code: **KLE**

Catalog Number	Description	Price Each
<b>GLOW IN THE DARK</b>		
11054GLW	7-1/8" Wire Stripper/Cutter	26.54
D200028GLW	8" Diagonal Cutting Pliers	39.97
D20009NEGLW	9" Side-Cutting Pliers	49.98

Tools, Terminals & Fasteners

K



### CRIMPING TOOLS FOR INSULATED AND NON-INSULATED CONNECTORS



Journeyman Series

Vendor Code: **KLE**

Catalog Number	Description	Price Each
<b>OVERALL LENGTH 9-3/4"</b>		
<b>1005</b>	Dipped Handles-Ins/Non Ins	32.63
<b>J1005</b>	Cushion Grip-Ins/Non Ins	42.29

### WIRE STRIPPER/CUTTER



11045

Vendor Code: **KLE**

Catalog Number	Description	Price Each
<b>11045</b>	Strips #8-14	16.18
<b>1011</b>	Strips #10-20	15.76

### KLEIN-KURVE™ WIRE STRIPPER/CUTTER



11055

Vendor Code: **KLE**

Catalog Number	Description	Price Each
<b>11055</b>	10 - 18 AWG Solid and 12 - 20 AWG Stranded Wire	24.56
<b>11053</b>	6 - 12 AWG Stranded Wire	24.56
<b>11054</b>	8 - 16 AWG Solid and 10 - 18 AWG Stranded Copper Wire	24.37

### KLEIN-KURVE™ DUAL NM CABLE STRIPPER/CUTTER

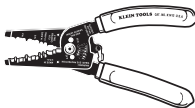

Vendor Code: **KLE**

Catalog Number	Description	Price Each
<b>OVERALL LENGTH 9-3/8"</b>		
<b>K1412</b>	Stripper/Cutter	26.99

### HEAVY-DUTY WIRE STRIPPERS



K12055

- Twist up to three wires at a time
- 6-32 and 8-32 screw shearing
- Knurled jaw for twisting, grabbing and looping wire

Vendor Code: **KLE**

Catalog Number	Description	Price Each
<b>OVERALL LENGTH 8"</b>		
<b>K12054</b>	Strips and Cuts 8-16 AWG Solid and 10-18 AWG Stranded	39.82
<b>K12055</b>	Strips and Cuts 10 - 18 AWG Solid and 12 - 20 AWG Stranded	40.79

### HYBRID PLIERS WITH CRIMPER



- Crimps non-insulated connectors, lugs and terminals
- 6-32 and 8-32 screw shearing
- Induction-hardened cutting knives for hard wire
- Dual-material Journeyman™ handles provide better grip and added comfort

Vendor Code: **KLE**

Catalog Number	Description	Price Each
<b>J2158CR</b>	Strips and Cuts 10-14 AWG Solid and 12-16 AWG Stranded Wire	44.96

### ELECTRICIAN'S SCISSORS



Vendor Code: **KLE**

Catalog Number	Description	Price Each
<b>21007</b>	Electrician's Scissors	19.64



### CABLE SPLICER'S KIT



Vendor Code: **KLE**

Catalog Number	Description	Price Each
<b>46037</b>	Splicer Kit with Knife, Scissors and Case	54.03

### CABLE-SPLICER'S KNIFE



44218

Vendor Code: **KLE**

Catalog Number	Description	Price Each
<b>44218</b>	Cable Skinning Utility Knife	22.65
<b>44219</b>	Replacement Blades (3-Pack of Blades for Cat. No. 44218)	13.76

### LOCKBACK KNIVES

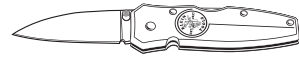

Drop Point Blade



Sheep Foot Blade



Compact Pocket Knife

Vendor Code: **KLE**

Catalog Number	Description	Price Each
<b>DROP POINT BLADE</b>		
<b>44001*</b>	2-1/2" Blade Length	51.04
<b>44001BLK*</b>	Black, 2-1/2" Blade Length	51.04
<b>SHEEP FOOT BLADE</b>		
<b>44005</b>	2-5/8" Blade Length	43.94
<b>COMPACT POCKET KNIFE</b>		
<b>44142</b>	2-7/8" Blade Length	23.33

\*Includes a Pocket/Belt Clip.

Tools, Terminals & Fasteners



FOLDING UTILITY KNIVES

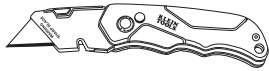

44131



44135

Vendor Code: **KLE**

Catalog Number	Description	Price Each
<b>6.25" OVERALL LENGTH</b>		
44131	Folding Lock Back	16.89
44135	Camouflage Assisted-Open	25.13

JAB SAW



Vendor Code: **KLE**

Catalog Number	Description	Price Each
31737	Folding Jab Saw	23.44

SCREWDRIVERS  
DEMOLITION DRIVERS



Vendor Code: **KLE**

Catalog Number	Description	Price Each
6024DD	4" Demolition Driver - 1/4" Keystone	17.97
6027DD	7" Demolition Driver - 5/16" Keystone	23.97

SCREWDRIVERS  
ROTARY



Vendor Code: **KLE**

Catalog Number	Description	Price Each
6706	3/16" Cabinet-Tip Rapi-Drive®	11.73
6826	#2 Phillips Rapi-Drive®	12.85

SCREWDRIVERS  
CUSHION-GRIP



6008



6124

Vendor Code: **KLE**

Catalog Number	Blade	Price Each
<b>HEAVY DUTY-SQUARE SHANK</b>		
6001	1-1/2" x 1/4"	8.99
6004	4" x 1/4"	11.99
6006	6" x 5/16"	13.49
6008	8" x 3/8"	19.37
<b>HEAVY DUTY-ROUND SHANK</b>		
6024	4" x 1/4"	11.21
6026	6" x 5/16"	13.57
<b>ELECTRICIAN ROUND SHANK</b>		
6013	3" x 3/16"	9.17
6014	4" x 3/16"	9.49
6016	6" x 3/16"	9.99
6018	8" x 3/16"	11.20
<b>ROUND TIP-PHILLIPS</b>		
6033	3" x #1	9.36
6034	4" x #2	9.99
6037	7" x #2	11.95
6031	10" x #2	9.17
6036	6" x #3	13.25
<b>CABINET POINT</b>		
6054	4" x 1/4"	9.57
6056	6" x 1/4"	10.36
6058	8" x 1/4"	12.23
<b>MINIATURE SCREWDRIVERS</b>		
6043	3" x #0	8.49
6062	2" x 1/16" Keystone	8.19
6073	3" x 3/32" Cabinet	8.49
6084	4" x 1/8" Cabinet	8.63
<b>TERMINAL BLOCK SCREWDRIVERS</b>		
6124	4" x 1/8"	8.65

SCREWDRIVER SET  
CUSHION-GRIP

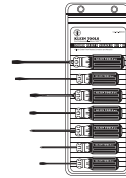

Vendor Code: **KLE**

Catalog Number	Description	Price Each
85076	7 Piece Cushion Grip Set (6004, 6026, 6013, 6016, 6054, 6033, 6034)	60.07

TAPPING TOOLS

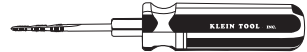

62720

Vendor Code: **KLE**

Catalog Number	Description	Price Each
62532	Replacement Tap for 626	18.35
62632	Replacement Tap for 62532	11.31
626	Cushion Grip Tool w/ 6/32, 8/32, 10/32, 10/24, 12/24, 1/4-20	30.54
62720*	Tool w/ 6/32, 8/32, 10/32	29.58

\*Two High-Carbon Steel Taps are Secured in Reversible Holder.

SCREWDRIVER  
SQUARE TIP



Vendor Code: **KLE**

Catalog Number	Description	Price Each
662	#2 Square Screwdriver, 4" Round Shank	9.97

WRENCHES  
DIPPED HANDLES



D50710

Vendor Code: **KLE**

Catalog Number	Description	Price Each
5078	8" Adjustable Wrench	30.62
50710	10" Adjustable Wrench	40.83
50712	12" Adjustable Wrench	59.64

**NEW** 7-IN-1 NUT DRIVER



Vendor Code: **KLE**

Catalog Number	Nut Driver Sizes	Price Each
32807MAG	1/4", 5/16", 11/32", 3/8", 1/2", 7/16", 9/16"	34.97



Tools, Terminals & Fasteners

K



## MULTI-BIT SCREWDRIVER/NUTDRIVER

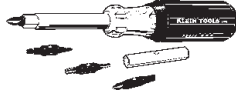

Vendor Code: **KLE**

Catalog Number	Description	Price Each
<b>32477</b>	10 - in - 1 Screwdriver/Nut Driver with 4" Shank Length	19.36
<b>32500</b>	11 - in - 1 Screwdriver/Nut Driver with 4" Shank Length	19.99
<b>32557</b>	Heavy Duty Multi-Bit Screwdriver/Nut Driver with 2-61/64" Shank Length	17.59
<b>32558</b>	Ratcheting Multi-Bit Screwdriver/Nut Driver with 2-61/64" Shank Length	26.37
<b>32561</b>	Stubby Multi-Bit Screwdriver/Nut Driver with 1-17/64" Shank Length	12.99

All sets have 3/16" & 1/4" Slotted, #1 & #2 Phillips, and 1/4" & 5/16" Nut Driver.

**32477** also includes T10 & T15 TORX® Bits and #1 & #2 Square Bits.

**32500** also includes T10 & T15 TORX® Bits, 3/8" Nutdriver, and #1 & #2 Square Bits.

**32557** also includes #1 & #2 Square Bits and 3/8" Hex Bit.

**32558** also includes 3/8" Nutdriver and 3/8" Hex Bit.

## COMBINATION CONDUIT REAMER AND SCREWDRIVER

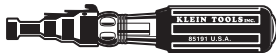

85191

Vendor Code: **KLE**

Catalog Number	Description	Price Each
<b>85191</b>	Reamer Head & Screwdriver	35.79
<b>19353</b>	Conduit Reamer Replacement Blade Kit	8.49

## PUMP PLIERS

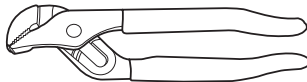

Vendor Code: **KLE**

Catalog Number	Overall Length	Max. Jaw Capacity	Price Each
<b>D5026</b>	6-1/2"	7/8"	20.59
<b>D50210</b>	10"	1-3/4"	27.67
<b>D50212</b>	12"	2-3/8"	33.71
<b>D50216</b>	16"	4-1/4"	64.38

Pliers have Plastic Dipped Handles

## NUT DRIVERS HOLLOW SHAFT, CUSHION GRIP

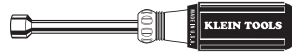

Vendor Code: **KLE**

Catalog Number	Shaft Length	Hex Size(s)	Price Each
<b>MAGNETIC</b>			
<b>631</b>	4"	Set of 7 (3/16", 1/4", 5/16", 11/32", 3/8", 7/16", 1/2")	58.97
<b>647M</b>	6"	Set of 7 (3/16", 1/4", 5/16", 11/32", 3/8", 7/16", 1/2")	84.64
<b>63014</b>	3"	1/4"	8.99
<b>630516</b>	3"	5/16"	9.17
<b>63038</b>	3"	3/8"	9.79
<b>630716</b>	3"	7/16"	10.05
<b>63012</b>	3"	1/2"	10.71
<b>630916</b>	4"	9/16"	13.24
<b>64614</b>	6"	1/4"	8.99
<b>646516</b>	6"	5/16"	9.17

## FOLDING HEX KEY SETS

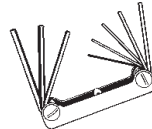

Vendor Code: **KLE**

Catalog Number	Keys	Sizes	Price Each
<b>70581</b>	8	1/20", 1/16", 5/64", 3/32", 7/64", 1/8", 9/64", 5/32"	6.99
<b>70591</b>	9	5/64", 3/32", 7/64", 1/8", 9/64", 5/32", 3/16", 7/32", 1/4"	9.99
<b>70579</b>	5	3/16", 7/32", 1/4", 5/16", 3/8"	11.99

## SAE JOURNEYMAN™ HEX KEY SET

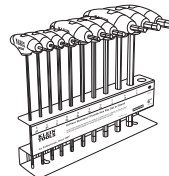

Vendor Code: **KLE**

Catalog Number	Description	Price Each
<b>JTH610E</b>	10 Piece T-Handle Set with Stand	54.99

Set Includes: 3/32", 7/64", 1/8", 9/64", 5/32", 3/16", 7/32", 1/4", 5/16", 3/8" and Metal Stand



**HIGH-TENSION HACKSAW**



- Adjustable blade tension up to 30,000 PSI for fast, precise cuts.
- Soft touch grips.
- Alternative 45° mounting for flush cutting.
- Front mount for reciprocating saw blades.
- Convenient blade storage in handle.
- Includes 12" x 24 TPI bi-metal hack saw blade and 6" x 24 TIP bi-metal reciprocating saw blade.

Vendor Code: **KLE**

Catalog Number	Blade Length	Overall Length	Weight	Price Each
70212	12"	16-1/4"	1.5 lbs.	30.94



**LASER LEVEL**



- Self-leveling, easy-to-read horizontal and vertical laser lines with plumb spot lasers to pinpoint overhead locations
- Projects horizontal and vertical lines independently or together for various alignments
- Water and dust resistant (IP54), hard plastic carrying case included

Vendor Code: **KLE**

Catalog Number	Description	Price Each
93LCLS	Self-Leveling Cross-Line Laser Level with Plumb Spot	166.39

**KNOCKOUT PUNCH SET WITH WRENCH**



- Cutting capacity 10 gauge mild steel; also cuts aluminum, fiberglass and plastic
- Splits slugs for easy removal
- Punches holes cleanly and accurately

Vendor Code: **KLE**

Catalog Number	Description	Price Each
53732SEN	1/2" to 2" Knockout Set with Wrench	300.57

Set Includes: 1" Ratcheting Wrench, Knockout Punches, Dies and Draw Studs for 1/2", 3/4", 1", 1-1/4", 1-1/2", and 2" Conduit Sizes.

**TAPE MEASURES**

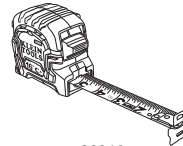

86216

Vendor Code: **KLE**

Catalog Number	Description	Price Each
86216	16" Double Hook Magnetic	21.23
86225	25" Double Hook Magnetic	26.55
86230	30" Double Hook Magnetic	36.25
86125	25" Non Magnetic	21.40

**LEVELS**

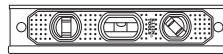

935R

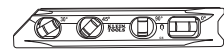

935RB

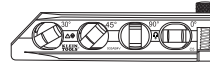

935AB4V

Vendor Code: **KLE**

Catalog Number	Description	Price Each
935R	9" Aluminum Torpedo Level Rare Earth Magnet	30.58
935RB	8" Torpedo Billet Level, Rare Earth Magnet	32.99
935AB4V	6-1/4" Accu-Bend™ 4 Vial Level Ultra Powerful Rare-Earth Magnet	28.28

**STRAIGHT-CLAW HAMMERS**

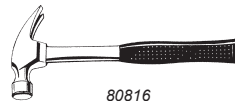

80816

- Durable plastic-alloy jacketing helps to protect neck from fraying and splintering if incorrectly struck or overstruck
- High-strength fiberglass shaft absorbs shock and keeps head tight
- Comfortable, perforated neoprene grip bonded to handle

Vendor Code: **KLE**

Catalog Number	Description	Price Each
80718	15" Length Electrician's Straight-Claw Hammer	44.91
80816	13" Length Heavy Duty Straight-Claw Hammer	36.74



Tools, Terminals & Fasteners

K



## GLOW ROD SETS



Vendor Code: **KLE**

Catalog Number	Description	Price Each
<b>56409</b>	9' Mid-Flex Glow Rod Set	44.99
<b>56415</b>	15' Mid-Flex Glow Rod Set	53.99
<b>56418</b>	18' Hi-Flex Glow Rod Set	62.99

## TUFF-GRIP PRO FISH TAPE WITH REEL



Vendor Code: **IDE**

Catalog Number	Description	Price Each
<b>STEEL</b>		
<b>31056</b>	120' x 1/8" x 0.060"	59.29
<b>31057</b>	240' x 1/8" x 0.060"	85.41
<b>STAINLESS STEEL</b>		
<b>31067</b>	240' x 1/8" x 0.060"	130.64
<b>FIBERGLASS</b>		
<b>31063</b>	100'	227.93

## WIRE PULLING COMPOUND



Vendor Code: **IDE**

Catalog Number	Description	Price Each
<b>YELLOW 77, WAX BASE</b>		
<b>31358</b>	1-Quart Squeeze Bottle	16.04
<b>31351</b>	1 Gallon Bucket	36.22
<b>31355</b>	5 Gallon Bucket	100.25
<b>AQUA GEL II WATER BASE, POLY GEL</b>		
<b>31378</b>	1 Quart Squeeze Bottle	12.41
<b>31371</b>	1 Gallon Bucket	28.98
<b>31375</b>	5 Gallon Bucket	94.34
<b>CLEARGLIDE, CLEAR POLY GEL</b>		
<b>31388</b>	1 Quart Squeeze Bottle	14.48
<b>31381</b>	1 Gallon Bucket	32.45
<b>31385</b>	5 Gallon Bucket	101.44

## POWR-FISH® PULL-LINE



- Continuous-fiber polyline great for blowing directly into conduit
- Will not rot or mildew
- Can be left in conduit for future use

Vendor Code: **IDE**

Catalog Number	Length	Tensile Strength (lbs.)	Tracer Color	Price Each*
<b>31348**</b>	500'	210	Blue	12.05
<b>31344*</b>	2,200'	500	Red	90.44
<b>31340*</b>	6,500'	210	Blue	47.20

\*Bucket

\*\*Canister

## FOAM CARRIERS



Vendor Code: **IDE**

Catalog Number	Size	Price Each
<b>31316</b>	1/2"	6.14
<b>31317</b>	3/4"	8.20
<b>31318</b>	1"	13.32
<b>31319</b>	1-1/4"	13.83
<b>31320</b>	1-1/2"	14.35
<b>31321</b>	2"	16.39
<b>31322</b>	2-1/2"	19.47
<b>31323</b>	3"	20.47
<b>31325</b>	4"	27.67

## POLY PULL TAPE

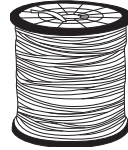

- Pre-lubed and low friction, providing a softer feel for easier handling
- Marked at 1" intervals for easy measuring

Vendor Code: **DOT**

Catalog Number	Width x Length	Tensile Strength (lbs.)	Price Each
<b>DWP500</b>	1/2" x 500'	1250	98.96
<b>DWP502</b>	3/4" x 500'	2500	104.98
<b>DWP1500</b>	1/2" x 1500'	1250	332.10
<b>DWP1502</b>	3/4" x 1500'	2500	576.52
<b>DWP3000</b>	1/2" x 3000'	1250	358.58
<b>DWP3002</b>	3/4" x 3000'	2500	470.08

## CONDUIT MEASURING TAPE



- Easy-to-read markings in sequential 1 ft. increments
- Pulls rope through raceways without stretching
- Will not rot or mildew

Vendor Code: **IDE**

Catalog Number	Length	Tensile Strength (lbs.)	Price Each
<b>31347</b>	3,000'	160	98.13



Conduit Benders · Marksman Conduit Layout Tool · Cleaners and Cutting Oil

IRON CONDUIT BENDER

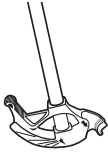

- Exclusive design reduces ripping and ovaling of conduit.
- Bold cast-in symbols, degree scales, multiplier scales and center of bend marks help save time on the job.
- High strength steel handle features a swaged end for inserting conduit to correct overbends (catalog numbers 56203 and 56204 only).
- Bright orange color handle is easy to spot on the jobsite.

Vendor Code: **KLE**

Catalog Number	EMT	Rigid / IMC	Price Each
<b>BENDER WITH HANDLE</b>			
56203	1/2"	-	74.99
56204	3/4"	1/2"	89.99
56205	1"	3/4"	114.99

MARKSMAN CONDUIT LAYOUT TOOL

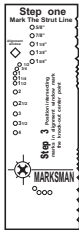

A conduit layout tool that will pinpoint a center knockout in seconds. The Marksman spacer also features a panel schedule showing the branch circuit number to its corresponding phase.

- 60 times faster than a tape measure
- Constructed from tough, durable, anodized aluminum
- Markings are laser etched for lasting durability
- For KO sizes 1/2" to 4"

Vendor Code: **MXT**

Catalog Number	Description	Price Each
MM01	Conduit Layout Tool	20.86



DARK CUTTING OIL

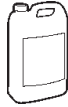

Dark Cutting Oil reduces friction and acts as an effective coolant and anti-weld agent during hand thread cutting operations and when using low rpm machines.

Vendor Code: **REC**

Catalog Number	Description	Price Each
94272	1 Gallon - Dark	29.49
94392	1 Quart - Dark	12.86

PVC CEMENT & PRIMER



Vendor Code: **REC**

Catalog Number	Color	Size	Carton Quantity	Price Each
<b>CEMENT</b>				
55983	Clear	Pint	12	11.30
55985	Clear	Quart	12	15.43
55986	Clear	Gallon	4	60.75
<b>PRIMER</b>				
55914	Purple	Pint	12	11.32
55918	Purple	Quart	12	15.93
55932	Clear	Pint	12	10.29
55934	Clear	Quart	12	15.43

NOTICE: Due to fluctuations in the market, PVC prices are subject to change weekly.



CRC CLEANERS, SILICONE & CUTTING OIL



Vendor Code: **CRC**

Catalog Number	Description	Price Each
02005	11 oz. 2-26 Precision Lube	9.99
02016	14 oz. Contact Cleaner	52.99
02018	20 oz. Smart Meter Lube	15.99
02130	11 oz. QD Contact Cleaner	17.99
02140	13 oz. Contact Cleaner 2000	29.99
03040	10 oz. Food Grade Silicone	9.99
14010	14 oz. Wasp & Hornet Spray Killer Plus Insecticide w/Trigger	11.99
14050	16 oz. Cutting Oil Thread Cutting Lubricant	12.99
14055	6.5 oz. Clear Silicone Sealant	27.99
14073	10.1 oz. Cartridge RTV Silicone Sealant - Clear	11.99
14077	12 oz. Expansion Foam Sealant	14.99
18412	13 oz. Zinc-It Instant Cold Galvanize	12.99
02083	10 oz. Di-Electric Grease	19.99
02180	19 oz. Electrical Parts Cleaner	11.99
02085	3.3 oz. Pressurized Tube Dielectric Grease Non-Curing	21.99
03020	13 oz. Knock'er Loose® Penetrating Solvent	10.99

SPRAY PAINT



Vendor Code: **CRC**

Catalog Number	Description	Price Each
18200	15 oz. Safety Red Marking Paint	11.97
18201	15 oz. Caution Yellow Marking Paint	11.97
18204	20 oz. Alert Orange Marking Paint	11.97
18210	20 oz. Red/Orange Floor Marking Paint	11.97
18411	13 oz. Clear Seal Coat	17.45



Tools, Terminals & Fasteners

K





### TRADESMAN PRO™ ORGANIZERS

#### BACKPACKS



55421BP14



55456BPL



55421BP14CAMO

#### 55421BP14

This backpack features 39 pockets for plenty of tool storage, including a hard, molded front pocket for safety glasses and a front zipper pocket to store loose parts. The bright orange interior will help you find your tools faster.

#### 55456BPL

Carry both your laptop and tools in the same bag. It has a separate compartment that keeps a laptop protected from other tools, plus 25 more pockets to designed to store adapters, cables, phones, and tools.

#### 55421BP14CAMO

This Camo Backpack features the Realtree® AP-Xtra Camouflage Design, which blends perfectly year-round in a variety of habitats, and looks great on the jobsite too. The backpack has shoulder straps with extra padding for comfort and handles for easy carrying. The fully molded bottom protects your cargo from the elements.

Vendor Code: **KLE**

Catalog Number	Description	Price Each
<b>55421BP14</b>	Tradesman Pro Backpack	109.99
<b>55456BPL</b>	Tradesman Pro Tech Backpack	140.22
<b>55421BP14CAMO</b>	Tradesman Pro Camo Backpack	124.99



#### WIDE OPEN TOOL BAG



Klein's Tradesman Pro™ Wide-Open Tool Bag is made to stay open and allow easy access to all your tools. This smart design is wider at the opening and bright orange on the inside so you can find your tools quickly. The tool bag also gives you a large interior space, inside zipper pocket and a multitude of various sized pockets for all your gear.

Vendor Code: **KLE**

Catalog Number	Description	Price Each
<b>55469</b>	Wide Open Tool Bag with 42 Pockets and Stay Open Top	106.48

#### SHOULDER POUCH



Vendor Code: **KLE**

Catalog Number	Description	Price Each
<b>55419SP14</b>	Tradesman Pro Shoulder Pouch with 14 Pockets	69.99

#### TOTE BAGS



55415814



554161014

#### 55415814

This 8" Tote has 20 pockets to store a wide variety of tools, including a large zipper pocket for small parts. A durable molded bottom protects from the elements.

#### 554161014

This 10" Tote has 40 pockets, including a large zipper pocket for small parts. A durable molded bottom protects from the elements.

Vendor Code: **KLE**

Catalog Number	Description	Price Each
<b>55415814</b>	Tradesman Pro 8" Tote	80.71
<b>554161014</b>	Tradesman Pro 10" Tote	100.59

### ZIPPER BAGS



5139C

#### 5139

Stay organized with the Canvas Zipper Bag. This natural colored canvas bag is perfect for storing most tools. The heavy-duty zipper keeps it securely closed.

#### 5139C

This bag is constructed of Cordura® fabric, a high-performance material resistant to abrasions, tears, and scuffs. Features the jungle stalker digitized camouflage pattern for maximum concealment. Heavy-duty nylon stitching and zipper ensure durability and long life. Convenient storage for tools and spare parts.

#### 5140

The popular canvas zipper bags are in a convenient 4-pack for even more organization. Each bag is a different color making it easy to store and identify your tools or spare parts. A heavy-duty brass zipper keeps these bags securely closed.

Vendor Code: **KLE**

Catalog Number	Description	Price Each
<b>5139</b>	Canvas Zipper Bag	11.49
<b>5139C</b>	Camouflage Zipper Bag	11.99
<b>5140*</b>	4 Multi-Color Canvas Bags	44.99

\*Includes Four Assorted Colors: Olive, Orange, Royal Blue, and Yellow.

### PHONE HOLDERS



55461



55468



55474

#### 55461

This model is designed to hold a Samsung Galaxy S 3 or 4, iPhone® 6 or any similar sized phones. It has a durable metal clip that attaches to belts up to 2" wide.

#### 55468

Fits iPhone 6 Plus, 7 Plus, Samsung Galaxy Note® Edge, Note® 7, and similar sized phones.

#### 55474

Fits iPhone 6 Plus, 7 Plus, 8 Plus, Samsung Galaxy® S7, S8, S8 Plus, S9, S9 Plus, Note® 7, Note® 8, Note® Edge, and similar sized phones.

Vendor Code: **KLE**

Catalog Number	Description	Price Each
<b>55461</b>	Tradesman Pro™ Phone Holder, Large	26.58
<b>55468</b>	Tradesman Pro™ Phone Holder, X-Large	27.80
<b>55474</b>	Tradesman Pro™ Phone Holder, XX-Large	25.93

Tools, Terminals & Fasteners





JOURNEYMAN™ GLOVES

Klein Tools' iconic JOURNEYMAN Gloves are designed for today's jobsite demands. They are constructed of the latest high-quality high-tech materials available. The new Journeyman Gloves provide ample comfort and functionality on and off the jobsite.

<p><b>Utility Gloves</b> Klein Tools Journeyman Utility gloves are a hi-tech update to one of the best-selling gloves. The anatomically designed palm eliminates material bunching for an exceptional fit. Your hands will stay cool, dry and comfortable with TrekDry material covering your wrist, thumb and fingers.</p>	
<p><b>Camouflage Gloves</b> Klein Tools Journeyman Camouflage gloves utilize synthetic leather in the palm and fingertips, extending the life of the glove while providing optimum dexterity. Form-fitting TrekDry material with Mossy Oak® Break-Up® Infinity camouflage helps keep your hands cool, dry and comfortable.</p>	
<p><b>Grip Gloves</b> Klein Tools Journeyman Grip gloves offer protection and ample gripping capability in wet and dry conditions. PORON® padding material in the palm absorbs impact. Great for wire pulling. Neoprene cuff and soft molded rubber closure with hook and loop secures fit.</p>	
<p><b>Cut 5 Resistant Gloves</b> Klein Tools Journeyman Cut Level 5 gloves provide protection, dexterity and extreme functionality on and off the jobsite. These gloves have been dipped for extra protection and are CE category II for immediate risk. The neoprene wrist closure provides extreme comfort.</p>	
<p><b>Leather Utility Gloves</b> Klein Tools Journeyman Leather Utility gloves are durable and comfortable and have an open cuff for an easy quick on and off. These gloves have a dura hide palm and leather first fingers for durability. The stretch back adds extra comfort and flexibility.</p>	

Vendor Code: **KLE**

Catalog Number	Size	Color(s)	Price Each
<b>JOURNEYMAN UTILITY GLOVES</b>			
40206	Large	Black/Gray	19.99
40207	X Large	Black/Gray	19.99
<b>JOURNEYMAN CAMOUFLAGE GLOVES</b>			
40209	Large	Camouflage*	26.99
40210	X Large	Camouflage*	26.99
<b>JOURNEYMAN GRIP GLOVES</b>			
40215	Large	Black	37.99
40216	X Large	Black	37.99
<b>JOURNEYMAN CUT 5 RESISTANT GLOVES</b>			
40224	Large	Black	31.99
40225	X Large	Black	31.99
<b>JOURNEYMAN LEATHER UTILITY GLOVES</b>			
40227	Large	Brown	25.99
40228	X Large	Brown	25.99

\*Mossy Oak® Break-Up Infinity Pattern



BATTERIES

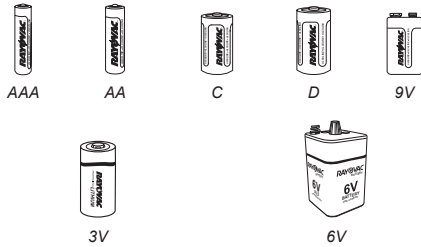

Vendor Code: **ROV**

Catalog Number	Description	Ctn. Qty.	Price per 100 pcs.
<b>INDUSTRIAL ALKALINE BATTERIES</b>			
ALAA8J	AAA Size	8	53.99
ALAA8J	AA Size	8	47.99
ALC6J	C Size	6	82.99
ALD12	D Size	12	105.99
AL9V8	9 Volt	8	164.99

Catalog Number	Description	Ctn. Qty.	Price Each
<b>LITHIUM PHOTO BATTERY</b>			
RL123ABULKA	3 Volt	100	2.99

Catalog Number	Description	Ctn. Qty.	Price Each
<b>LANTERN BATTERY</b>			
944A	6 Volt Heavy Duty Spring Terminal	1	3.99

FLASHLIGHTS

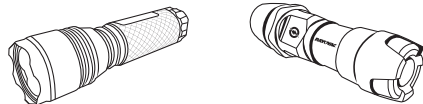

RNT3AAAAB

DIY3AAAAC

**RoughNeck 3AAA LED Tactical Flashlight**

A smart flashlight to keep around. This tactical Roughneck flashlight features a Cree™ LED that gives off 220 lumens, and includes three lighting modes (high, low, strobe). The aircraft-grade aluminum body holds up through anything and the AAA batteries are easy to replace when the time comes.

**Workhorse Pro™ 3AAA LED Virtually Indestructible Flashlight**

Reliable light in a durable package. The Virtually Indestructible Flashlight shines with powerful LEDs and an aluminum-titanium casing that can survive a 30-foot drop. Plus, Energy Saver mode gives you extended use for the long haul.

Vendor Code: **ROV**

Catalog Number	Lumens	Battery Size	Price Each
<b>ROUGHNECK 3AAA LED TACTICAL</b>			
RNT3AAAAB	260	(3) AAA	25.99
<b>WORKHORSE PRO™ 3AAA LED VIRTUALLY INDESTRUCTIBLE</b>			
DIY3AAAAC	250	(3) AAA	19.99





## LADDERS



Step Ladder

Extension Ladder

Cross-Step Ladder

### Step Ladder

- Multi-functional Raptor Top with multiple tool slots and magnet
- Non-marring tread delivers slip-resistant footing and durability

### Extension Ladder

- Direct rung to rail connection for a stronger connection
- Heavy duty metal slide guides

### Cross Step Ladder

- ProTop™ keeps your tools right where you need them
- Heavy-duty interior support braces protect the ladder during transport to extend its lifespan.

Vendor Code: **LOU**

Catalog Number	Size	Weight (lbs.)	Price Each
<b>300 LB. STEP LADDERS</b>			
FS1504	4'	14	89.17
FS1506	6'	20	117.73
FS1508	8'	26	156.70
FS1510	10'	29	233.34
FS1512	12'	46	286.05
<b>375 LB. REINFORCED STEP LADDERS</b>			
FS1406HD	6'	21	165.00
FS1408HD	8'	26	217.99
FS1410HD	10'	42	289.67
FS1412HD	12'	53	354.70
<b>300 LB. EXTENSION LADDERS</b>			
FE3224	24'	51	289.78
<b>300 LB. CROSS STEP LADDERS</b>			
FXS1504	4'	15	106.60
FXS1506	6'	21	138.69
FXS1508	8'	27	186.29
FXS1510	10'	39	273.23
FXS1512	12'	48	335.32



## SHOVELS

NEW

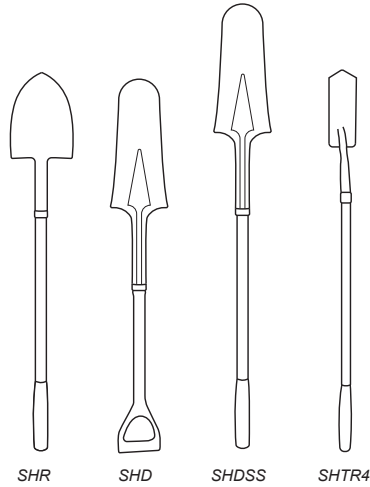

SHR

SHD

SHDSS

SHTR4

Dottie's Professional Grade Shovels are a unique compound construction fabricated out of fiberglass strands cured under tension in a thermosetting resin and wrapped in polypropylene. The hollow fiberglass core adds strength and rigidity maximizing performance and minimizing weight. The compression bar fills the throat of the blade reinforcing the highest point of stress.

- Ergonomically Designed Cushion Grip
- Resists Industrial Chemicals
- Industrial Breaking Strength
- Does Not Absorb Moisture
- Standard 48" or 27" D-Handle

Vendor Code: **DOT**

Catalog Number	Description	Handle Length	Price Each
SHR	#2 Round Point	48"	59.88
SHD	14" Drain Spade	48"	62.12
SHDSS	14" Sharpshooter	27" (D Handle)	66.62
SHTR4	4" Trenching	48" Handle	60.52

## EXTENSION CORDS

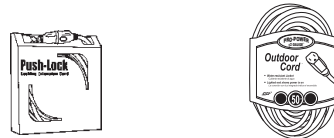

Vendor Code: **COR**

Catalog Number	Description	Price Each
<b>PUSH-LOCK LOCKING CORDS</b>		
025188826	45' 12/3 SJTW	39.99
<b>ALL PURPOSE WITH INDICATOR LIGHT</b>		
025880206	50' 12/3 SJTW	42.99
025890206	100' 12/3 SJTW	74.99

Tools, Terminals & Fasteners





**SAFETY VESTS**

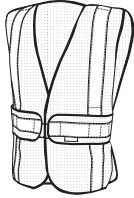

- Scotchlite reflective material for increased visibility
- Easy to put on and take off with hook and loop fasteners
- Lightweight, breathable mesh for air circulation & faster drying

Vendor Code: **SCO**

Catalog Number	Description	Price Each
9462580030T	High-Visibility Fluorescent Orange Reflective Class 2 Construction Safety Vest	18.33
9461780030T	High-Visibility Yellow Polyester Reflective Class 2 Construction Reflective Safety Vest	18.41

**GLOVES**



Comfort Grip  
General Use



Comfort Grip  
Cut Resistant



Gripping  
Material

**Comfort Grip General Use Gloves**

Nitrile palm coating makes this glove a light, flexible, abrasion-resistant and long lasting alternative to many cotton and latex palm-coated gloves.

**Comfort Grip Cut Resistant Gloves (ANSI 3)**

These medium-duty gloves have the same features as the General Use Glove with even greater cut, puncture and tear resistance. They're excellent for jobs requiring dexterity when handling sharp parts.

**Gripping Material Work Gloves**

Comprised of thousands of micro fingers, these work gloves provide excellent grip, even in dirty, wet or oily conditions.

Vendor Code: **SCO**

Catalog Number	Size	Color	Price Each
<b>COMFORT GRIP GLOVES - GENERAL USE</b>			
CGMGU	Medium	Gray	6.49
CGLGU	Large	Gray	6.65
CGXLGU	Extra Large	Gray	6.66
<b>COMFORT GRIP GLOVES - CUT RESISTANT (ANSI 3)</b>			
CGMCR	Medium	Gray	21.06
CGLCR	Large	Gray	21.21
CGXLCR	Extra Large	Gray	21.38
<b>GRIPPING MATERIAL WORK GLOVES</b>			
WGM12	Medium	Black/Gray	32.96
WGL1	Large	Black/Gray	46.45
WGX12	Extra Large	Black/Gray	34.49



**PROTECTIVE EYEWEAR**



Industrial safety eye wear is designed to protect you. Available in a variety of styles, finishes, and color tints, they are designed down to the smallest detail to provide optimal performance with state of the art comfort, style, and protection.

Vendor Code: **SCO**

Catalog Number	Frame	Lens Color	Price Each
<b>STYLE: SPORT</b>			
113431000020	Nickel	Clear	11.07
113441000020	Nickel	Gray	11.41
113451000020	Nickel	Mirror	11.91
113461000020	Nickel	Amber	9.99
115401000020	Nickel	Blue	11.67

**HARD HATS**

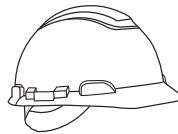

H-700 Series

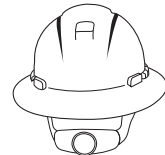

Full Brim H-800 Series

**H-700 Series**

Protective hard hat with comfortable 4-point pinlock suspension and standard brow pad. Available in several colors. Meets requirements of ANSI/ISEA Z89.1-2014 Type 1, Class G and E.

- Suspension sits lower on head to reduce pressure and increase security
- Comfortable, easy adjusting pinlock suspension
- Optimized comfort with three levels of adjustment

**Full Brim H-800 Series**

Protective full brim hard hat with comfortable 4-point ratchet suspension and standard brow pad and Uvicutor™ Sensor. Available in several colors. Meets requirements of ANSI/ISEA Z89.1-2014 Type 1, Class G and E.

- Impact resistant, ANSI Type I hard hat wears lightweight and comfortable on the head
- Comfortable suspension sits lower on head to reduce pressure points
- Smooth, easy turning ratchet suspension is easy to adjust
- 4-point ratchet suspension with three position height adjustment allows for customized fit
- Uvicutor™ sensor shows when it's time to replace hard hat due to UV exposure

Vendor Code: **SCO**

Catalog Number	Color	Style	Price Each
<b>H-700 SERIES</b>			
H701P	White	Cap	10.58
<b>FULL BRIM H-800 SERIES</b>			
H801RUEVA*	White	Full Brim	22.58

\*Includes UV Indicator That Lets Wearer Know When to Replace Hat Due to UV Exposure.

Tools, Terminals & Fasteners

K



## Rags · Caulk and Sealants · Multi-Purpose Towels · Fire Protection Products

**NEW**

### WIPING RAGS



- Rags are all new material bleached knit. They are medium weight, random size, soft, absorbent and are a low linting premium all purpose wipe.

Vendor Code: **DOT**

Catalog Number	Description	Price Each
<b>RGZ2</b>	Two Pound Bag of New White Knit Rags	14.12

### CAULK & SEALANTS GUN AND AEROSOL CAN

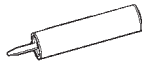

RTV10



HF340

Vendor Code: **DOT**

Catalog Number	Color	Description	Price Each
<b>RTV3</b>	Clear	3 Ounce Tube	5.99
<b>RTV10</b>	Clear	10.1 Ounce Cartridges	12.72
<b>HF340</b>	Foam	12 Ounce Pres. Can	14.19
<b>CAULKING GUN</b>			
<b>CG10</b>		Caulking Gun	7.28

### MULTI-PURPOSE TOWELS IDEAL WIPES™



Vendor Code: **IDE**

Catalog Number	Description	Price Each
<b>38500</b>	12" x 9" (82 Towels in a Can)	20.36



### FIRE BARRIER SEALANT



FD150+RED



FD150+RED(200Z)

3M™ Fire Barrier Sealant FD 150+ is an economical alternative to firestopping applications. It is used to firestop metal pipes or cables through concrete or gypsum, and for use in dynamic head-of-wall systems. A single-part, sag-resistant, water-based acrylic latex sealant, 3M Fire Barrier Sealant FD 150+ has excellent adhesion characteristics to most common construction materials. And, since it dries to the touch within one hour, it can be painted for a more professional-looking job.

Vendor Code: **SCO**

Catalog Number	Description	Price Each
<b>LATEX CAULK, RED COLOR</b>		
<b>FD150+RED</b>	10.1 fl. oz. Cartridge	5.00
<b>FD150+RED(200Z)</b>	20 fl. oz. in a Sausage Pack	15.58

### FIRECAULK



High-performance latex-based intumescent firestop sealant. When properly installed, this product provides up to 4-hour fire protection in tested and listed systems. Firestops items penetrating through fire-rated construction assemblies. Dries to red color, no mixing required.

Vendor Code: **SCO**

Catalog Number	Description	Price Each
<b>CP25WB+</b>	Firecaulk (10.1 oz.)	15.52



### FIRE PROTECTION PRODUCTS



66366

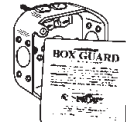

66367

#### 66335

Metacaulk® Putty Pads are used to maintain the hourly rating of fire-rated walls containing electrical outlet boxes and to reduce sound transmission. Only one pad thickness (1/8 inch) is required for a 1 or 2 hour fire rating. No additional putty material needed to plug the end of each electrical metallic tube or conduit at its connection to the box. Hand moldable with no curing time required. STC rating 60, Tested in a UL 411 wall assembly/section to ASTM E90.

#### 66366 and 66367

Metacaulk® Box Guard™ is a highly intumescent, fire-rated pad for use in electrical boxes. For steel electrical box membrane penetration applications, it is inserted on the inside back wall of an electrical box. When exposed to fire, Box Guard™ will expand forming a char that will seal off the opening and prevent the spread of flames and limit the temperature rise on the unexposed surfaces. A labor saving, economical alternative to putty pads. Great for retrofit jobs. STC 53 Rating, Tested in a UL 411 wall assembly/section to ASTM E90

Vendor Code: **REC**

Catalog Number	Description	Price Each
<b>66335</b>	Metacaulk Puddy Pad 7" x 7" x 1/8"	7.26
<b>66366</b>	Metacaulk Single Gang Box Guard 1-13/16" x 2-13/16" x 1/4"	5.65
<b>66367</b>	Metacaulk Double Gang Box Guard 3-11/16" x 3-3/4" x 1/4"	6.17



Tools, Terminals & Fasteners





VINYL ELECTRICAL TAPE



Vendor Code: **SCO**

Catalog Number	Description	Price Each
1700	3/4" x 60' x .007" General Use	2.10
33	3/4" x 66' x .007" Premium	6.40
88	3/4" x 66' x .0085" Super Premium	11.22
88SUPER	1-1/2" x 44' x .0085" Super Premium	12.22

VINYL ELECTRICAL TAPE COLOR CODING



Vendor Code: **SCO**

Catalog Number	Description	Price Each
1700CWH	3/4" x 60' General Use	2.61
35WH	3/4" x 66' Premium	5.68
35WH12	1/2" x 20' Premium	1.71

Catalog Numbers Listed Above are White. Replace WH with BL for Blue, BR for Brown, GR for Green, GY for Gray, OR for Orange, PR for Purple, RD for Red, or YE for Yellow.

RUBBER SPLICING TAPE



Vendor Code: **SCO**

Catalog Number	Description	Price Each
<b>LINERLESS</b>		
130C34X30	3/4" x 30', 600V	17.45
130C112X30	1-1/2" x 30', 600V	33.94
130C2X30FT	2" x 30', 600V	40.75
<b>WITH LINER</b>		
2155	3/4" x 22' x .76", 600V	4.82
23	3/4" x 30', 600V - 6.9KV	17.99
70	1" x 30', 15KV+	51.99

DUCT TAPE



Vendor Code: **SCO**

Catalog Number	Description	Color	Price Each
3939	2" x 60 Yards	Grey	13.47

MASTIC PADS RATED FOR DIRECT BURIAL

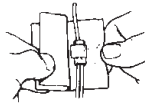

Vendor Code: **SCO**

Catalog Number	Size	Ctn. Qty.	Price Each
2200	3.25" x 4.25" Mastic Pad	10*	4.68
2200L	6.5" x 4.5" Mastic Pad	10*	6.80
2210	3.75" x 10' Vinyl Mastic Roll	10*	64.10

\*Bulk Packed, No Inner Carton.

SCOTCHFIL INSULATION PUTTY IN TAPE FORM



Vendor Code: **SCO**

Catalog Number	Description	Price Each
SCOTCHFIL	1.5" x 60' x .125", 600V	14.24

GLASS CLOTH TAPE



Vendor Code: **SCO**

Catalog Number	Description	Price Each
27	3/4" x 66' x .007", 600V / 130°C	24.96

VARNISHED CAMBRIC ELECTRICAL INSULATING TAPE

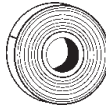

Vendor Code: **SCO**

Catalog Number	Description	Price Each
2510	3/4" x 60' x .007"	28.19
2520	3/4" x 60' x .008"	35.56



SCOTCHWRAP CORROSION PROTECTION TAPE



Vendor Code: **SCO**

Catalog Number	Size	Carton Quantity	Price Each
50	2" x 100' x .010"	1	25.47

ELECTRICAL COATING



3M™ Scotchkote™ Electrical Coating FD is intended for use as a moisture and corrosion resistant outer seal on vinyl tape applications which are subjected to excessive amounts of oil. It is designed to improve the weather resistance of the taped splice. It meets state and local Volatile Organic Compound (VOC) limits.

- Rubber Coating to seal vinyl tape in a variety of environments
- Fast drying

Vendor Code: **SCO**

Catalog Number	Description	Price Each
SCOTCHKOTE	15 oz. Brush-top Can	31.59

UNDERGROUND SPLICE KITS

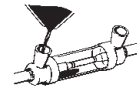

Vendor Code: **SCO**

Catalog Number	Connection Size	Cable O.D.	Price Each
<b>RESIN IN LINE</b>			
82A	10 - 2 AWG	.750"	42.59
82A1	2 AWG	.625"	37.01
82A2	2 - 3/0 AWG	1"	59.41
82A3	3/0 AWG - 400 MCM	1.56"	95.88

1kV Multiple Conductors. 5kV Single Conductors.

DUCT SEAL



Vendor Code: **DOT**

Catalog Number	Description	Price Each
LHD1	1 lb. Plug	4.46
LHD5	5 lb. Plug	17.97

Tools, Terminals & Fasteners

K



## HEAT SHRINK TUBING



Vendor Code: **SCO**

Catalog Number	Description	Price Each
<b>THIN WALL - SHRINK RATIO UP TO 2:1</b>		
FP3011848BLACK	1/8" x 48"	1.78
FP30131648BLACK	3/16" x 48"	2.40
FP3011448BLACK	1/4" x 48"	2.74
FP3013848BLACK	3/8" x 48"	3.33
FP3011248BLACK	1/2" x 48"	6.10
FP3013448BLACK	3/4" x 48"	4.39
<b>THICK WALL - SHRINK RATIO UP TO 4:1</b>		
ITCSN040048	#12-6 x 48"	34.06
ITCSN080048	#8-1/0 x 48"	35.84
ITCSN110048	#2-4/0 x 48"	44.53
ITCSN150048	#3/0-400 x 48"	54.91
ITCSN200048	250-750 x 48"	71.70
ITCSN08006	#8-1/0 x 6"	6.78
ITCSN08009	#8-4/0 x 9"	8.19
ITCSN11009	#2-4/0 x 9"	11.14
ITCSN15009	#3/0-400 x 9"	14.75

Other Colors of Thin Wall Heat Shrink Tubing Available

## NEW INSURE® PUSH-IN WIRE CONNECTORS



Vendor Code: **IDE**

Catalog Number	Description	Quantity per Jar	Price per 100 pcs.
301032J	12 AWG, 2-Port	300	12.37
301033J	12 AWG, 3-Port	250	12.72
301034J	12 AWG, 4-Port	200	13.05

## TAPE

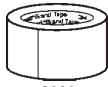

3939



302



406



364

Vendor Code: **MIL**

Catalog Number	Description	Color	Price Each
<b>DUCT TAPE</b>			
3939	2" x 60 Yards	Grey	13.47
<b>NON-DETECTABLE UNDERGROUND TAPE</b>			
22126	3" x 1,000'	Red	18.73
<b>DETECTABLE UNDERGROUND TAPE</b>			
31107	3" x 1,000'	Red	39.87
<b>BARRICADE (CAUTION) TAPE</b>			
22202	3" x 1,000'	Yellow	17.72

## SUPER PERFORMANCE PLUS SPRING CONNECTORS



T/R+ 2 #18 - 5 #12    T/Y+ 2 #22 - 3 #12

Vendor Code: **SCO**

Catalog Number	Wire Size Range	Carton Quantity	Price per 100 pcs.
TY+BOX	2 #22 - 3 #12	100	14.90
TR+BOX	2 #18 - 5 #12	100	22.02
RY+BOX	2 #18 - 2 #8	100	19.96
BG+BOX	4 #14 - 2 #6	50	56.07
<b>BULK PACKED</b>			Price per 1000 pcs.
TY+JUG	2 #22 - 3 #12	750	92.62
TR+JUG	2 #18 - 5 #12	750	81.89
RY+BULK	4 #18 - 2 #8	750	108.36

## SELF-STRIPPING CONNECTORS

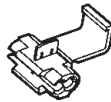

Vendor Code: **SCO**

Catalog Number	Wire Size Range	Carton Quantity	Price per 100 pcs.
557	22 - 16 AWG	100	28.50
560	18 - 14 AWG	100	21.81
567	16 - 12 AWG	100	42.19
562	12 - 10 AWG	100	35.27

## BREAKER LOCKOUTS



44809

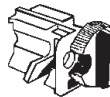

44783

Vendor Code: **IDE**

Catalog Number	Description	Price Each
44809*	Single Pole Breaker Lockout	50.26
44783	Multi-Pole Breaker Lockout	17.15

\*Three Devices per Package.

## HEAVY DUTY LOCKOUT TAGS



Vendor Code: **IDE**

Catalog Number	Description	Carton Quantity	Price Each
44833	Red Striped Background	5	29.26

## FIXTURE DISCONNECTS



Vendor Code: **IDE**

Catalog Number	Wire Size Range	Ctn. Qty.	Price per 100 pcs.
30372	Solid 18 - 12 AWG Stranded 14 - 12 AWG	25	153.19
30382J	Solid 18 - 12 AWG Stranded 14 - 12 AWG	75	128.21

## WIRE NUTS

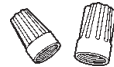

Vendor Code: **IDE**

Catalog Number	Color	Wire Size Range	Ctn. Qty.	Price per 100 pcs.
WT11	Gray	22 - 14 AWG 3 #22 - 2 #16	100	7.86
WT21	Blue	22 - 14 AWG 3 #20 - 3 #16	100	7.89
WT31	Orange	22 - 14 AWG 2 #18 - 2 #14	100	8.32
WT41	Yellow	22 - 10 AWG 3 #20 - 2 #12	100	9.59
WT61	Red	20 - 8 AWG 2 #14 - 4 #12	100	13.74

## B-CAP CONNECTORS



Vendor Code: **IDE**

Catalog Number	Color	Wire Size Range	Ctn. Qty.	Price per 100 pcs.
<b>BOXED</b>				
B11	Yellow	3 #20 - 3 #12	100	18.79
B21	Red	2 #18 - 5 #12	100	25.47
B41	Blue/Gray	2 #12 - 2 #6	25	60.75
<b>BULK PACKED</b>				Price per 1000 pcs.
B1B	Yellow	3 #20 - 3 #12	500	75.83
B2B	Red	2 #18 - 5 #12	500	100.57

## LOW VOLTAGE COMMUNICATIONS CONNECTORS



VDV826604

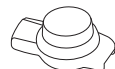

VDV826605

Vendor Code: **KLE**

Catalog Number	Wire Size Range	Carton Quantity	Price Each
VDV826604	22 - 26 AWG	25	6.12
VDV826605	19 - 26 AWG	25	6.12

Tools, Terminals & Fasteners





Split-Bolt Connectors · Bolted Butt Splices · Bolted Lugs · Oxide Inhibitors

SPLIT-BOLT CONNECTORS



COPPER TO COPPER

Vendor Code: **TAB**

Catalog Number	Wire Size Range	Carton Quantity	Price per 100 pcs.
9H	12 Solid – 10 Stranded	100	364.34
8H	10 Solid – 8 Stranded	100	334.50
6H	8 Solid – 6 Solid	100	334.50
4H	8 Solid – 4 Solid	100	339.31
3H	8 Solid – 3 Solid	100	399.89
2H	6 Solid – 2 Solid	100	642.30
2H3*	6 Solid – 2 Solid	100	735.63
1H3*	6 Solid – 2 Str.	100	674.24
1H	6 Solid – 2 Stranded	100	660.09
10H	4 Solid – 1/0 Stranded	50	1058.58
20H	2 Solid – 2/0 Stranded	25	1467.34
30H	2 Solid – 4/0 Stranded	25	1842.05
40H	1 Str. – 250 MCM	25	2048.05
350M	250 – 350 MCM	1	4508.23
500M	400 – 500 MCM	1	5775.64

\*Accommodates 3 Wires of Maximum Size.

ALUMINUM TO COPPER

Vendor Code: **TAB**

Catalog Number	Wire Size Range	Carton Quantity	Price per 100 pcs.
6HPS	12 Solid – 6 Solid	100	419.21
4HPS	12 Solid – 4 Solid	100	505.33
2HPS	8 Solid – 2 Solid	100	656.83
10HPS	6 Solid – 1/0 Stranded	50	1589.16
20HPS	6 Solid – 2/0 Stranded	25	1589.16
40HPS	4 Solid – 4/0 Stranded	25	2712.23

SINGLE TERMINAL LUGS FOR COPPER CONDUCTORS



Vendor Code: **TAB**

Catalog Number	Wire Size Range	Carton Quantity	Price per 100 pcs.
L35	14 – 8 AWG	100	137.55
L70	14 – 4 AWG	100	242.40
L125BB	8 – 1/0 AWG	100	332.65
L250	6 AWG – 250 MCM	50	1157.36

BOLTED BUTT SPLICES FOR ALUMINUM OR COPPER

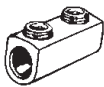

Vendor Code: **TAB**

Catalog Number	Wire Size Range	Carton Quantity	Price per 100 pcs.
ASR0214	14 – 2 AWG	12	690.06
ASR1114	14 – 1/0 AWG	12	771.99
ASR2506	6 AWG – 250 MCM	12	1725.18
ASR3506	6 AWG – 350 MCM	12	3959.59

BOLTED LUGS FOR ALUMINUM OR COPPER



ADR6



ADR1121

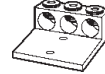

ADR0232

Vendor Code: **TAB**

Catalog Number	Wire Size Range	Carton Quantity	Price per 100 pcs.
<b>SINGLE CONDUCTOR ONE-HOLE</b>			
ADR6	14 – 6 AWG	50	67.27
ADR2	14 – 2 AWG	50	93.27
ADR11	14 – 1/0 AWG	25	126.02
ADR21	14 – 2/0 AWG	25	139.34
ADR25	6 AWG – 250 MCM	25	427.74
ADR30	6 AWG – 300 MCM	25	543.73
ADR35	6 AWG – 350 MCM	12	581.68
ADR50	4 AWG – 500 MCM	6	908.91
ADR60	2 AWG – 600 MCM	6	931.91
<b>SINGLE CONDUCTOR TWO-HOLE</b>			
ADR6012D	2 AWG – 600 MCM	3	1519.68
<b>TWO CONDUCTOR</b>			
ADR1121	14 – 1/0 AWG	12	307.91
ADR2121	14 – 2/0 AWG	12	312.65
ADR2521	6 AWG – 250 MCM	12	870.12
ADR3521	6 AWG – 350 MCM	6	1208.19
ADR6021	2 AWG – 600 MCM	4	1951.16
<b>THREE CONDUCTOR</b>			
ADR0232	14 – 2 AWG	6	1211.88
ADR1132	14 – 1/0 AWG	6	1954.94
ADR2532	6 AWG – 250 MCM	6	2629.80
ADR3532	6 AWG – 350 MCM	3	2150.61

INSULATION PIERCING TAP CONNECTORS



Vendor Code: **TAB**

Catalog Number	Wire Size Range	Price per 100 pcs.
IPC1102	8 – 1/0 AWG	1672.68
IPC4111	1/0 – 4/0 AWG	1866.82

OXIDE INHIBITORS



Vendor Code: **TAB**

Catalog Number	Description	Price per 100 pcs.
CTB8	8 oz. Contax Oxide Inhibiting Compound	1329.75







### GANGABLE BLOCKS

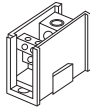

Vendor Code: **NSI**

Catalog Number	Line (Lugs)	Load (No Lugs)	Price Each
<b>SINGLE LINE / SINGLE LOAD</b>			
ASI111	14 - 2 AWG	14 - 2 AWG	13.37
ASK1K1	14 - 2/0 AWG	14 - 2/0 AWG	16.67
AMN1N1	6 AWG - 250 MCM	6 AWG - 250 MCM	30.38
AMP1P1	6 AWG - 350 MCM	6 AWG - 350 MCM	29.90
AMR1R1	4 AWG - 500 MCM	4 AWG - 500 MCM	44.47
<b>SINGLE LINE / MULTI LOAD</b>			
ASK1H4	14 - 2/0 AWG	(4) 14 - 4 AWG	16.89
ASK1H6	14 - 2/0 AWG	(6) 14 - 4 AWG	33.02
ALP1K6	6 AWG - 350 MCM	(6) 14 - 2/0 AWG	45.93
ALR1M4	4 AWG - 500 MCM	(4) 6 - 4/0 AWG	58.66
<b>DUAL LINE / MULTI LOAD</b>			
AMK2H6	14 - 2/0 AWG	(6) 14 - 4 AWG	28.57
AMN2I6	14 - 2/0 AWG	(6) 14 - 2 AWG	35.08
ALP2K6	6 AWG - 350 MCM	(6) 14 - 2/0 AWG	51.96
ALR2R2	4 AWG - 500 MCM	(2) 4 AWG - 500	52.61

Rated at 90°C

### INSULATED MULTI-TAP CONNECTORS ALUMINUM OR COPPER

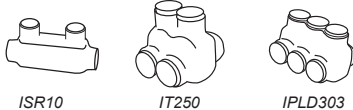

Vendor Code: **NSI**

Catalog Number	Wire Size Range*	Price Each
<b>SINGLE POLE</b>		
ISR10	14 - 1/0 AWG	24.78
ISR250	6 AWG - 250 MCM	40.58
ISR350	6 AWG - 350 MCM	41.15
ISR500	4 AWG - 500 MCM	61.20
<b>TWO POLE</b>		
IT4	14 - 4 AWG Same Side	15.61
IT04	14 - 4 AWG Opposite Sides	16.71
IT10	14 - 1/0 AWG Same Side	21.57
IT010	14 - 1/0 AWG Opposite Sides	23.47
IT30	6 - 3/0 AWG Same Side	26.68
IT030	6 - 3/0 AWG Opposite Sides	29.63
IT250	6 AWG - 250 MCM Both Sides	38.71
IT350	6 AWG - 350 MCM Both Sides	49.36
IT500	4 AWG - 500 MCM Both Sides	72.87
<b>THREE POLE</b>		
IPLD303	6 - 3/0 AWG Both Sides	40.27
IPLD2503	6 AWG - 250 MCM Both Sides	44.68
IPLD3503	6 AWG - 350 MCM Both Sides	50.77
IPLD5003	4 AWG - 500 MCM Both Sides	74.40

\*Other Wire Sizes and Openings Available for Multi-Tap Connectors.



### MULTI-TAP CONNECTORS

#### POLARIS™ EDGE, GREY, AND VISION TAP

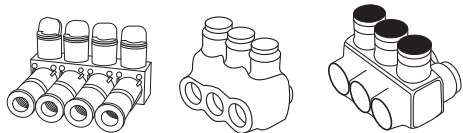

Polaris Edge

Polaris Grey

Polaris Vision Tap

Vendor Code: **NSI**

Catalog Number	Wire Size Range	Price Each
<b>POLARIS EDGE™</b>		
ISPBS20	2/0 AWG - 14 AWG 2 Port	37.07
ISPB020	2/0 AWG - 14 AWG 3 Port	42.53
ISPB202	2/0 AWG - 14 AWG 2 Port	32.43
ISPB203	2/0 AWG - 14 AWG 3 Port	42.53
ISPBS350	350 MCM - 12 AWG 2 Port	42.86
ISPB3503	350 MCM - 12 AWG 3 Port	42.16
ISPB3504	350 MCM - 12 AWG 4 Port	57.02
ISPB3506	350 MCM - 12 AWG 6 Port	71.91
<b>POLARIS GREY™</b>		
ITG1	10-1 AWG (B, C, D) 10-2 AWG (K, M, I) 2 Port	27.65
IPLG13	10-1 AWG (B, C, D) 10-2 AWG (K, M, I) 3 Port	37.36
ITG6	14-6 AWG (B, C, D, K, M, I) 2 Port	16.52
IPLG63	14-6 AWG (B, C, D, K, M, I) 3 Port	19.03
ITG30	4-3/0 AWG (B, C, D) 2-2/0 AWG (K, M, I) 2 Port	30.05
IPLG303	4-3/0 AWG (B, C, D) 2-2/0 AWG (K, M, I) 3 Port	38.79
<b>POLARIS VISION TAP™</b>		
IPL43C	14 AWG - 4 AWG 3 Port	25.15
ISR10C	14 AWG - 1/0 AWG 2 Port	24.76
IPL103C	14 AWG - 1/0 AWG 3 Port	31.68
IPLD303C	6 AWG - 3/0 AWG 3 Port	40.47
ISR250C	6 AWG - 250 MCM 2 Port	40.58
IPLD2503C	6 AWG - 250 MCM 3 Port	44.69

### EASY-TWIST™ WIRE CONNECTORS

#### WINGED



Square wire spring provides secure gripping of conductors. Flame retardant thermoplastic shell provides excellent electrical insulation. The compact design ensures proper installation, especially in tight spaces.

Vendor Code: **NSI**

Catalog Number	Wire Size Range	Carton Quantity	Price per 1000 pcs
WWCTB	Tan 22-8 AWG	500	58.45
WWCYB	Yellow 18-10 AWG	500	56.98
WWCRB	Red 18-8 AWG	500	52.86
WWCGB	Grey 18-8 AWG	250	115.24
WWCBB	Blue 14-6 AWG	100	159.18
WWCGRB	Green Grounding	500	63.45

Tools, Terminals & Fasteners





Compression Lugs · Standard and Long Butt Splices · Compression Crimping Tools

ONE HOLE COMPRESSION LUGS  
STANDARD BARREL

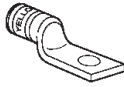

Vendor Code: TAB

Catalog Number	Wire Size	Bolt Size	Color Key	Ctn. Qty.	Price per 100 pcs.
<b>FOR COPPER CABLE</b>					
54104	8 AWG	#10	Red	50	158.71
54130	8 AWG	1/4"	Red	50	158.71
54105	6 AWG	1/4"	Blue	50	170.15
54136	6 AWG	3/8"	Blue	169	156.56
54106	4 AWG	1/4"	Gray	50	229.70
54139	4 AWG	5/16"	Gray	50	229.70
54140	4 AWG	3/8"	Gray	50	229.70
54107	2 AWG	1/4"	Brown	50	309.06
54108	1 AWG	1/4"	Green	50	449.35
54147	1 AWG	5/16"	Green	50	449.35
54109	1/0 AWG	3/8"	Pink	50	475.56
54110	2/0 AWG	3/8"	Black	50	555.49
54111	3/0 AWG	3/8"	Orange	50	573.25
54112	4/0 AWG	3/8"	Purple	50	629.76
54113	250 MCM	1/2"	Yellow	50	721.80
54174	250 MCM	3/8"	Yellow	50	757.62
54115	350 MCM	1/2"	Red	50	914.86
54116	400 MCM	1/2"	Blue	50	1061.59
54118	500 MCM	1/2"	Brown	50	1251.46
<b>FOR ALUMINUM / COPPER</b>					
60109TB	6 AWG	3/8"	Gray	50	792.58
60114TB	4 AWG	3/8"	Green	50	750.13
60120	2 AWG	1/2"	Pink	50	1103.64
60123	1 AWG	5/16"	Gold	50	1155.30
60130	1/0 AWG	3/8"	Tan	50	1225.78
60134	2/0 AWG	1/2"	Olive	50	1507.18
60142	3/0 AWG	3/8"	Ruby	50	1715.01
60148	4/0 AWG	3/8"	White	50	2217.40
60156	250 MCM	1/2"	Red	50	2310.48
60166	350 MCM	5/8"	Brown	50	3409.18
60172	500 MCM	5/8"	Pink	50	5042.20

LONG BARREL

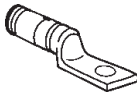

Vendor Code: TAB

Catalog Number	Wire Size	Bolt Size	Color Key	Ctn. Qty.	Price per 100 pcs.
<b>FOR COPPER</b>					
54930BE	8 AWG	1/4"	Red	50	206.61
54905BE	6 AWG	1/4"	Blue	50	262.53
54906BE	4 AWG	1/4"	Gray	50	249.99
54942BE	2 AWG	5/16"	Brown	25	469.97
54947BE	1 AWG	5/16"	Green	20	468.01
54909BE	1/0 AWG	3/8"	Pink	10	684.38
54910BE	2/0 AWG	3/8"	Black	10	698.97
54951BE	2/0 AWG	1/2"	Black	5	719.42
54965BE	3/0 AWG	1/2"	Orange	10	757.28
54970BE	4/0 AWG	1/2"	Purple	10	870.88
54913BE	250 MCM	1/2"	Yellow	10	1250.96
54915BE	350 MCM	1/2"	Red	10	1413.26
54918BE	500 MCM	1/2"	Brown	6	2041.31
54920BE	600 MCM	5/8"	Green	6	3178.38

TWO HOLE COMPRESSION LUGS  
STANDARD BARREL



Vendor Code: TAB

Catalog Number	Wire Size	Bolt Size	Color Key	Ctn. Qty.	Price per 100 pcs.
<b>FOR COPPER</b>					
54206	4 AWG	1/4"	Gray	50	663.44
54207	2 AWG	1/4"	Brown	25	762.23
54209	1/0 AWG	3/8"	Pink	10	1200.76
54210	2/0 AWG	3/8"	Black	10	1235.27
54212	4/0 AWG	3/8"	Purple	10	1276.33

LONG BARREL

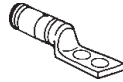

Vendor Code: TAB

Catalog Number	Wire Size	Bolt Size	Color Key	Ctn. Qty.	Price per 100 pcs.
<b>FOR COPPER</b>					
54852BE	6 AWG	1/4"	Blue	50	856.12
54854BE	4 AWG	1/4"	Gray	50	878.97
54855BE	2 & 3 AWG	1/4"	Brown	10	924.61
54857BE	1 AWG	1/2"	Green	10	993.11
54860BE	1/0 AWG	1/2"	Pink	10	1100.28
54862BE	2/0 AWG	1/2"	Black	10	1121.43
54864BE	3/0 AWG	1/2"	Orange	10	1184.93
54866BE	4/0 AWG	1/2"	Purple	10	1216.66
54868BE	250 MCM	1/2"	Yellow	10	1368.11
54872BE	350 MCM	1/2"	Red	10	1650.40
54876BE	500 MCM	1/2"	Brown	6	2215.04
54878BE	600 MCM	1/2"	Green	6	3294.98

STANDARD BUTT SPLICES



Vendor Code: TAB

Catalog Number	Wire Size	Color Key	Ctn. Qty.	Price per 100 pcs.
<b>FOR COPPER</b>				
54504	8 AWG	Red	50	199.21
54505	6 AWG	Blue	50	278.13
54506	4 AWG	Gray	50	354.78
54507	2 AWG	Brown	25	449.90
54508	1 AWG	Green	20	477.33
54509	1/0 AWG	Pink	10	388.10
54510	2/0 AWG	Black	10	431.53
54511	3/0 AWG	Orange	10	487.78
54512	4/0 AWG	Purple	10	536.78
54513	250 MCM	Yellow	10	873.11
54515	350 MCM	Red	10	998.94
54518	500 MCM	Brown	6	1494.38
<b>FOR ALUMINUM / COPPER</b>				
60501TB	8 AWG	Blue	20	234.85
60507TB	6 AWG	Gray	10	467.51
60512	4 AWG	Green	10	501.37
60516	2 AWG	Pink	10	675.95
60522TB	1 AWG	Gold	10	1138.22
60530TB	1/0 AWG	Tan	10	1379.90
60536	2/0 AWG	Olive	5	1455.76
60542	3/0 AWG	Ruby	5	1728.29
60548	4/0 AWG	White	5	1787.76

LONG BUTT SPLICES



Vendor Code: TAB

Catalog Number	Wire Size	Color Key	Ctn. Qty.	Price per 100 pcs.
<b>FOR COPPER</b>				
54804	8 AWG	Red	50	168.16
54805	6 AWG	Blue	50	217.15
54806	4 AWG	Gray	50	289.56
54807	2 AWG	Brown	25	367.50
54808	1 AWG	Green	20	428.75
54809	1/0 AWG	Pink	10	824.12
54810	2/0 AWG	Black	10	898.25
54811	3/0 AWG	Orange	10	932.23
54812	4/0 AWG	Purple	10	1032.16
54813	250 MCM	Yellow	10	1257.04
54815	350 MCM	Red	10	1457.76
54818	500 MCM	Brown	6	2195.47

COMPRESSION CRIMPING TOOLS

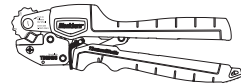

TBM45S



TBM5S

TBM45S FEATURES

- Installs Compression Connectors, C-Taps and Splices
- A Rotary Color-Coded Die Wheel Is Rotated into Position and Each Die Has Die Code Embossing
- Requires Two Crimps per Connector
- 5-15 lbs. Force Across Handles

TBM5S FEATURES

- Wide range of #8 AWG to 250 kcmil for copper and #10 to 4/0 AWG for aluminum lugs and splices
- Also installs C-taps from 54705 to 54750
- Shure Stake<sup>®</sup> mechanism ensures a properly completed crimp each time
- Includes color-coded, die code-embossed installation dies

Vendor Code: TAB

Catalog Number	Description	Price Each
TBM45S	Hand Compression Connector Tool	214.16
TBM5	Crimps #8-250MCM Cu, #10-4/0 Al Connectors, 54705-54750 C-Taps	447.99

Tools, Terminals & Fasteners





## VINYL INSULATED LOCKING FORK STA-KON TERMINALS

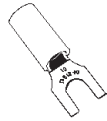

### INDUSTRIAL GRADE

Vendor Code: **TAB**

Catalog Number	Wire Size Range	Bolt Size	Ctn. Qty.	Price per 100 pcs.
<b>18RA6FLE</b>	22 - 18 AWG	#6	100	33.60
<b>14RB6FLE</b>	18 - 14 AWG	#6	100	36.19
<b>14RB8FLE</b>	18 - 14 AWG	#8	100	33.48
<b>14RB10FLE</b>	18 - 14 AWG	#10	100	33.48
<b>10RC6FLE</b>	12 - 10 AWG	#6	50	43.87
<b>10RC8FLE</b>	12 - 10 AWG	#8	50	43.87
<b>10RC10FLE</b>	12 - 10 AWG	#10	50	43.79

### COMMERCIAL GRADE

Vendor Code: **TAB**

Catalog Number	Wire Size Range	Bolt Size	Ctn. Qty.	Price per 100 pcs.
<b>TV188FXV</b>	22 - 18 AWG	#8	15	31.14
<b>TV148FXV</b>	16 - 14 AWG	#8	15	35.10
<b>TV1410FXV</b>	16 - 14 AWG	#10	15	35.10
<b>TV108FXV</b>	12 - 10 AWG	#8	15	38.97
<b>TV1010FXV</b>	12 - 10 AWG	#10	15	38.97

## VINYL INSULATED RING TYPE STA-KON TERMINALS



### INDUSTRIAL GRADE

Vendor Code: **TAB**

Catalog Number	Wire Size Range	Bolt Size	Ctn. Qty.	Price per 100 pcs.
<b>14RB8E</b>	18 - 14 AWG	#8	100	42.27
<b>14RB10E</b>	18 - 14 AWG	#10	100	42.27
<b>10RC8E</b>	12 - 10 AWG	#8	50	56.76
<b>10RC10E</b>	12 - 10 AWG	#10	50	54.68
<b>10RC14E</b>	12 - 10 AWG	1/4"	50	58.25

### COMMERCIAL GRADE

Vendor Code: **TAB**

Catalog Number	Wire Size Range	Bolt Size	Ctn. Qty.	Price per 100 pcs.
<b>TV148RXV</b>	16 - 14 AWG	#8	15	43.67
<b>TV1410RXV</b>	16 - 14 AWG	#10	15	43.67
<b>TV108RXV</b>	12 - 10 AWG	#8	15	48.12
<b>TV1010RXV</b>	12 - 10 AWG	#10	15	48.12
<b>TV1014RXV</b>	12 - 10 AWG	1/4"	15	48.12

## VINYL INSULATED BUTT TYPE SPLICES



### INDUSTRIAL GRADE

Vendor Code: **TAB**

Catalog Number	Wire Size Range	Carton Quantity	Price per 100 pcs.
<b>2RA18XE</b>	22 - 18 AWG	100	45.12
<b>2RB14XE</b>	16 - 14 AWG	100	45.12
<b>2RC10XE</b>	12 - 10 AWG	50	59.94

### COMMERCIAL GRADE

Vendor Code: **TAB**

Catalog Number	Wire Size Range	Carton Quantity	Price per 100 pcs.
<b>TV18BSXV</b>	22 - 18 AWG	15	34.60
<b>TV14BSXV</b>	16 - 14 AWG	15	39.00
<b>TV10BSXV</b>	12 - 10 AWG	15	43.29

## QUICK DISCONNECT STA-KON TERMINALS

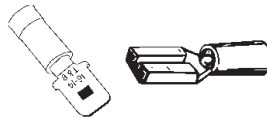

MALE

FEMALE

### INDUSTRIAL GRADE

Vendor Code: **TAB**

Catalog Number	Wire Type	Wire Size Range (AWG)	Ctn. Qty.	Price per 100 pcs.
<b>TAB SIZE .250 X .032</b>				
<b>18RA250FE</b>	Female	22 - 18	100	33.06
<b>14RB250FE</b>	Female	16 - 14	100	34.08
<b>10RC250FE</b>	Female	12 - 10	50	44.10
<b>14RB250TE</b>	Male	16 - 14	100	36.12

### COMMERCIAL GRADE

Vendor Code: **TAB**

Catalog Number	Wire Type	Wire Size Range (AWG)	Ctn. Qty.	Price per 100 pcs.
<b>TAB SIZE .250 X .032</b>				
<b>TV18250FDXV</b>	Female	22 - 18	100	32.43
<b>TV14250FDXV</b>	Female	16 - 14	100	36.56
<b>TV10250FDXV</b>	Female	12 - 10	50	40.59

## CRIMPING TOOL

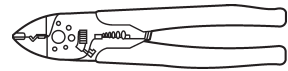

WT2000

Vendor Code: **TAB**

Catalog Number	For Use With	Price Each
<b>WT2000</b>	Insulated Terminals	60.16

## COMPRESSION H-TAP CONNECTORS

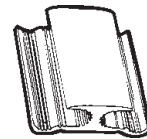

Vendor Code: **TAB**

Catalog Number	Stranded Wire		Price per 100 pcs.
	Main Max.	Tap Min.	
<b>WR159</b>	1 AWG	6 AWG	115.13
<b>WR189</b>	2/0 AWG	6 AWG	115.13
<b>WR289</b>	3/0 AWG	6 AWG	198.00
<b>WR419</b>	4/0 AWG	3/0 AWG	219.87
<b>WR399</b>	4/0 AWG	1/0 AWG	205.94
<b>WR1010</b>	2/0 AWG	4 AWG	114.00
<b>WR259</b>	2/0 AWG	1/0 AWG	314.31
<b>WR9</b>	2 AWG	14 AWG	115.13
<b>WR139*</b>	2/0 AWG	10 & 14 AWG	167.96

Contains Two Taps

## CRIMPING TOOL FOR INSULATED & NON-INSULATED CONNECTORS



Journeyman Series

Vendor Code: **KLE**

Catalog Number	Description	Price Each
<b>OVERALL LENGTH 9-3/4"</b>		
<b>1005</b>	Dipped Handles-Ins/Non Ins	32.63
<b>J1005</b>	Cushion Grip-Ins/Non Ins	42.29



Tools, Terminals & Fasteners





TY-RAP® CABLE TIES

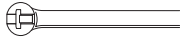

TY525ME



TY534M

INDUSTRIAL GRADE

- Ty-rap® 316 stainless steel locking device in the nylon head assures that the tie exceeds the minimum pullout strength requirements specified in MIL-S-23190

Vendor Code: **TAB**

Catalog Number	Length	Carton Quantity	Price per 100 pcs.
<b>WHITE, INDOOR USE ONLY</b>			
TY523ME	3.62"	100	11.25
TY524ME	5.5"	100	12.71
TY525ME	7.31"	100	16.12
TY526ME	11.41"	100	23.30
TY527ME	13.38"	100	53.91
TY528ME	14.19"	100	37.21
TY529M	30"	50	191.36
<b>WHITE, WITH MOUNTING HEAD</b>			
TY534M	6"	100	44.28
TY535M	7.8"	100	44.48
<b>BLACK, OUTDOOR RATED</b>			
TY523MXE	3.62"	100	14.55
TY524MXE	5.5"	100	15.75
TY525MXE	7.31"	100	17.22
TY526MXE	11.41"	100	30.28
TY527MXE	13.4"	100	59.21
TY528MXE	14.19"	100	39.04

COMMERCIAL GRADE

- Commercial Grade have nylon locking devices for cost effective applications

Vendor Code: **TAB**

Catalog Number	Length	Carton Quantity	Price per 100 pcs.
<b>WHITE, INDOOR USE ONLY</b>			
L4189C	4"	100	11.37
L5309C	5.6"	100	8.24
L8409C	8.5"	100	9.73
L11409C	11.5"	100	20.12
L14409C	14.5"	50	26.95
<b>BLACK, OUTDOOR RATED</b>			
L4180C	3.62"	100	8.78
L5300C	5.5"	100	10.46
L8400C	7.31"	100	11.26
L11400C	11.41"	100	25.13
L14400C	13.38"	100	31.46
L241200L	24.2"	50	73.95

TY-RAP® ADHESIVE MOUNTING BASE

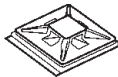

Vendor Code: **TAB**

Catalog Number	Description	Carton Quantity	Price per 100 pcs.
<b>INDUSTRIAL GRADE</b>			
TC5342AE	2-Way Base	100	75.57
TC5344AE	4-Way Base	100	71.48
<b>COMMERCIAL GRADE</b>			
MPNY1000A9C	2-Way Base	100	66.49
MPNY750A9C	4-Way Base	100	58.45

WIRE MARKERS



- Pocket pack wire marker books are easy to carry and easy to use
- Exclusive tab design allows you to take off marker without touching adhesive
- All purpose vinyl coated cloth tape exclusively designed to resist abrasion, oil, water and dirt

Vendor Code: **TAB**

Catalog Number	Contents of Each	Carton Quantity	Price Each
WM09	• Quantity 40: 0 - 9 • Quantity 10: T1, T2, T3 • Quantity 10: L1, L2, L3	10	22.97
WM045	• Quantity 10: 0 - 45	10	22.97
WM4690	• Quantity 10: 46 - 90	10	22.97
WMAZ	• Quantity 10: A - Z, +, - • Quantity 10: 0 - 15	10	22.97
WMA33	• Quantity 10: 1 - 33 • Quantity 10: A, B, C, +, - • Quantity 10: T1, T2, T3 • Quantity 10: L1, L2, L3	10	22.97

WIRE MARKING

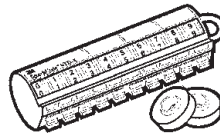

Vendor Code: **SCO**

Catalog Number	Description	Price Each
SDR0	Wire Marker Tape #0	3.73
SDR1	Wire Marker Tape #1	3.73
SDR2	Wire Marker Tape #2	3.73
SDR3	Wire Marker Tape #3	3.73
SDR4	Wire Marker Tape #4	3.73
SDR5	Wire Marker Tape #5	3.73
SDR6	Wire Marker Tape #6	3.73
SDR7	Wire Marker Tape #7	3.73
SDR8	Wire Marker Tape #8	3.73
SDR9	Wire Marker Tape #9	3.73
STD09	0 - 9 Tape Dispenser	28.66
SWD	Write-on Tape Dispenser	36.02





## ROUND HEAD MACHINE SCREWS COMBINATION SLOT/PHILLIPS ZINC FINISH



Vendor Code: **DOT**

Catalog Number	Size	Length	Carton Qty.	Price per 100 pcs.
RMC6322	6/32"	2"	100	8.60
RMC83212	8/32"	1/2"	100	3.92
RMC83234	8/32"	3/4"	100	4.60
RMC8321	8/32"	1"	100	4.64
RMC832114	8/32"	1-1/4"	100	6.64
RMC832112	8/32"	1-1/2"	100	7.13
RMC8322	8/32"	2"	100	10.11
RMC8323	8/32"	3"	100	18.95
RMC10241	10/24"	1"	100	5.68
RMC10322	10/32"	2"	100	11.03
RMC1438	1/4"	3/8"	100	7.45
RMC1412	1/4"	1/2"	100	8.43
RMC1434	1/4"	3/4"	100	8.71
RMC141	1/4"	1"	100	10.83
RMC14114	1/4"	1-1/4"	100	11.18
RMC14112	1/4"	1-1/2"	50	12.10
RMC142	1/4"	2"	50	13.49

## FLAT HEAD SLOTTED MACHINE SCREWS



Vendor Code: **DOT**

Catalog Number	Size	Length	Carton Quantity	Price per 100 pcs.
FM63212	6/32"	1/2"	100	3.98
FM63234	6/32"	3/4"	100	3.83
FM6321	6/32"	1"	100	4.05
FM632114	6/32"	1-1/4"	100	4.80
FM632112	6/32"	1-1/2"	100	6.55
FM6322	6/32"	2"	100	9.05
FM6323	6/32"	3"	100	16.88

## MACHINE SCREW KITS

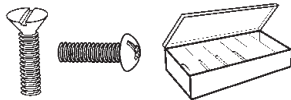

Vendor Code: **DOT**

Catalog Number	Description	Ctn. Qty.	Price Each
632	370 Assorted 6/32" Slotted Flat Head 3/4-3" Lengths	1	23.97
632PS	370 Assorted 6/32" Phillips/Slotted Round Head 1/2"-2" Lengths	1	23.97
832PS	370 Assorted 8/32" Phillips/Slotted Round Head 1/2"-2" Lengths	1	25.97

# Dottie

## HEX HEAD CAP SCREWS



Vendor Code: **DOT**

Catalog Number	Description	Carton Quantity	Price per 100 pcs.
<b>HEX HEAD CAP SCREWS</b>			
MB1434	1/4-20 x 3/4"	100	11.45
MB141	1/4-20 x 1"	100	12.70
MB14114	1/4-20 x 1-1/4"	100	15.78
MB14112	1/4-20 x 1-1/2"	100	16.48
MB142	1/4-20 x 2"	100	19.83
MB3834	3/8-16 x 3/4"	100	24.08
MB381	3/8-16 x 1"	100	29.80
MB38114	3/8-16 x 1-1/4"	100	33.55
MB38112	3/8-16 x 1-1/2"	100	37.08
MB382	3/8-16 x 2"	100	44.20
MB12112	1/2-13 x 1-1/2"	50	63.53
<b>HEX NUTS</b>			
HN632	6-32	100	3.40
HN832	8-32	100	3.83
HN1024	10-24	100	4.05
HN1032	10-32	100	4.05
HN14	1/4-20	100	5.17
HN38	3/8-16	50	14.94
HN12	1/2-13	25	25.58

## WASHERS



Vendor Code: **DOT**

Catalog Number	Description	Carton Quantity	Price per 100 pcs.
<b>FENDER WASHERS</b>			
FENW316114	3/16 x 1-1/4"	100	11.28
FENW141	1/4 x 1"	50	8.10
FENW14114	1/4 x 1-1/4"	100	11.05
FENW14112	1/4 x 1-1/2"	50	14.78
FENW38114	3/8 x 1-1/4"	100	14.78
FENW38112	3/8 x 1-1/2"	100	14.78
FENW12112	1/2 x 1-1/2"	50	14.78
<b>LOCK WASHERS</b>			
LW14	1/4"	100	3.18
LW38	3/8"	100	5.10
LW12	1/2"	100	8.75
<b>FLAT STANDARD WASHERS</b>			
FW8	#8	100	3.35
FW10	#10	100	3.83
FW14	1/4"	100	4.85
FW516	5/16"	100	6.53
FW38	3/8"	100	8.95
FW12	1/2"	50	19.95

## LAG BOLTS



Vendor Code: **DOT**

Catalog Number	Size	Length	Ctn. Qty.	Price per 100 pcs.
LAG14112	1/4 x 1-1/2"	7/16"	100	26.20
LAG142	1/4 x 2"	7/16"	100	27.83
LAG143	1/4 x 3"	7/16"	100	34.78
LAG383	3/8 x 3"	7/16"	100	66.88
LAG384	3/8 x 4"	7/16"	100	88.33

## EYE BOLTS WITH NUTS



Vendor Code: **DOT**

Catalog Number	Size	Carton Quantity	Price per 100 pcs.
EB10	3/8 x 4"	50	280.18
EB11	3/8 x 5"	50	322.31

## SPRING TGGLE BOLTS



Vendor Code: **DOT**

Catalog Number	Size	Carton Quantity	Price per 100 pcs.
<b>COMBO - MUSHROOM HEAD</b>			
TBC83	1/8 x 3"	50	39.05
TBC363	3/16 x 3"	50	47.67
TBC364	3/16 x 4"	50	51.07
TBC43	1/4 x 3"	50	56.80
TBC44	1/4 x 4"	50	59.37
<b>SLOTTED - MUSHROOM HEAD</b>			
TB384	3/8 x 4"	50	185.87

## JACK CHAIN



Vendor Code: **DOT**

Catalog Number	Description	Load Limit	Ctn. Qty.	Price per 100 pcs.
CH1212	#12 Jack Chain	28	100	65.26
S1	S Hook	40	100	14.15

## STEEL TIE WIRE

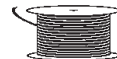

Vendor Code: **DOT**

Catalog Number	Gauge	Roll Quantity	Carton Quantity	Price Each
<b>BLACK ANNEALED</b>				
TY164	16-1/2	400'	1	11.97
<b>GALVANIZED</b>				
VTYG	16-1/2	400'	1	16.47

Tools, Terminals & Fasteners

K



HEX HEAD SHEET METAL SCREWS



Vendor Code: DOT

Catalog Number	Size	Hex Size	Carton Quantity	Price per 100 pcs.
HWSMS834	8 x 3/4"	1/4"	100	7.74
HWSMS81	8 x 1"	1/4"	100	9.09
HWSMS1012	10 x 1/2"	5/16"	100	8.97
HWSMS1034	10 x 3/4"	5/16"	100	11.04
HWSMS101	10 x 1"	5/16"	100	12.30
HWSMS10114	10 x 1-1/4"	5/16"	100	13.62
HWSMS10112	10 x 1-1/2"	5/16"	100	15.09
HWSMS102	10 x 2"	5/16"	50	23.34
HWSMS10212	10 x 2-1/2"	5/16"	100	25.35
HWSMS103	10 x 3"	5/16"	100	29.88
HWSMS121	12 x 1"	5/16"	100	11.25

SLOT/PHILLIPS SHEET METAL SCREWS



Vendor Code: DOT

Catalog Number	Size	Carton Quantity	Price per 100 pcs.
2WS812	8 x 1/2"	100	5.82
2WS834	8 x 3/4"	100	6.93
2WS81	8 x 1"	100	7.86
2WS8114	8 x 1-1/4"	100	9.21
2WS1012	10 x 1/2"	100	7.71
2WS1034	10 x 3/4"	100	8.55
2WS101	10 x 1"	100	10.08
2WS10114	10 x 1-1/4"	100	11.73
2WS10112	10 x 1-1/2"	100	13.17
2WS121	12 x 2"	100	14.07

FRAMER SCREWS



Vendor Code: DOT

Catalog Number	Size	Head Type	Carton Quantity	Price per 100 pcs.
F6716	6 x 7/16"	Phillips Pan Head	100	4.28

DRYWALL SCREWS

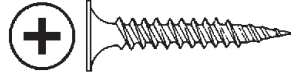

Vendor Code: DOT

Catalog Number	Description	Carton Quantity	Price per 100 pcs.
<b>FINE THREAD</b>			
DWSBX61	6 x 1"	100	4.45
DWSBX6118	6 x 1-1/8"	100	4.83
DWSBX6114	6 x 1-1/4"	100	4.93
DWSBX6158	6 x 1-5/8"	100	5.90
DWSBX62	6 x 2"	100	7.80
<b>COURSE THREAD</b>			
WR62	6 x 2"	100	7.82

METAL PIERCING K-LATH SCREWS

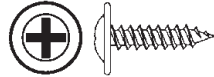

Vendor Code: DOT

Catalog Number	Size	Head Type	Carton Quantity	Price per 100 pcs.
KW812	8 x 1/2"	Phillips Wafer	100	4.64
KW834	8 x 3/4"	Phillips Wafer	100	5.48
<b>TUFF PACK</b>				
KWT812	8 x 1/2"	Phillips Wafer	1000	4.64
KWT834	8 x 3/4"	Phillips Wafer	50	5.51

SELF DRILLING TEK SCREWS



Vendor Code: DOT

Catalog Number	Size	Head Type	Carton Quantity	Price per 100 pcs.
<b>PHILLIP WAFER HEAD</b>				
TEKW812	8 x 1/2"	Phillips	100	9.15
TEKW834	8 x 3/4"	Phillips	100	13.88
<b>PHILLIP WAFER HEAD - TUFF PACK</b>				
TEKWT812	8 x 1/2"	Phillips	100	9.15
TEKWT834	8 x 3/4"	Phillips	100	13.88
<b>HEX WASHER HEAD</b>				
TEKHW812	8 x 1/2"	Hex	100	10.13
TEKHW834	8 x 3/4"	Hex	100	11.25
TEKHW81	8 x 1"	Hex	100	12.33
TEKHW1012	10 x 1/2"	Hex	100	13.48
TEKHW1034	10 x 3/4"	Hex	100	14.58
TEKHW101	10 x 1"	Hex	100	16.76
TEKHW10114	10 x 1-1/4"	Hex	100	17.87
TEKHW10112	10 x 1-1/2"	Hex	100	19.63
TEKHW102	10 x 2"	Hex	50	21.60
TEKHW1234	12 x 3/4"	Hex	100	20.23
<b>HEX WASHER HEAD - TUFF PACK</b>				
TEKHT1034	10 x 3/4"	Hex	500	14.55
TEKHT101	10 x 1"	Hex	500	8.91

Tools, Terminals & Fasteners

K

Dottie



## WEDGE ANCHORS STUDS FOR CONCRETE

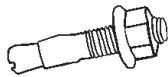

Vendor Code: **DOT**

Catalog Number	Description	Ctn. Qty.	Price per 100 pcs.
W14134	1/4" x 1-3/4" Stainless	100	112.64
W14214	1/4" x 2-1/4"	100	136.02
W38214	3/8" x 2-1/4"	100	176.17
W38234	3/8" x 2-3/4"	100	179.83
W38300	3/8" x 3"	100	180.38
W38334	3/8" x 3-3/4"	50	241.52
W12334	1/2" x 3-3/4"	50	313.05
W12512	1/2" x 5-1/2"	50	473.33

## PLASTIC ANCHORS DRYWALL, CONCRETE, BRICK

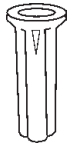

Vendor Code: **DOT**

Catalog Number	Description	Carton Quantity	Price per 100 pcs.
22	3/16" x 3/4"	100	4.79

## MACHINE SCREW ANCHORS



### ANCHORS

Vendor Code: **DOT**

Catalog Number	Description	Drill Size	Carton Quantity	Price per 100 pcs.
MA5	1/4"	1/2"	100	61.65
MA7	3/8"	3/4"	50	145.62

## SETTING TOOL FOR MA ANCHORS

Vendor Code: **DOT**

Catalog Number	Description	Carton Quantity	Price Each
ST5	1/4" for MA5	1	10.95
ST7	3/8" for MA7	1	12.91

# Dottie

## DROP-IN ZINC-PLATED ANCHORS



### ANCHORS

Vendor Code: **DOT**

Catalog Number	Description	Drill Size	Carton Quantity	Price per 100 pcs.
DA25	1/4"	3/8"	100	128.75
DA38	3/8"	1/2"	50	189.83

## SETTING TOOL FOR DA ANCHORS

Vendor Code: **DOT**

Catalog Number	Description	Carton Quantity	Price Each
AT25	1/4" for DA25	1	14.75
AT38	3/8" for DA38	1	18.66

## DRYWALL ANCHORS AND KITS

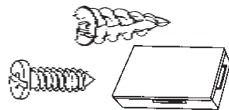

### ANCHORS

Vendor Code: **DOT**

Catalog Number	Description	Ctn. Qty.	Price per 100 pcs.
WD8N	Nylon #8 Anchor	100	41.26
WD8	Zinc #8 Anchor	100	41.26

### KITS

Vendor Code: **DOT**

Catalog Number	Description	Ctn. Qty.	Price Each
WDK8	8 x 1-1/4" Zinc, Display*	1	29.37
WDK8N	8 x 1-1/4" Nylon, Display*	1	31.12
WDK8T	8 x 1-1/4" Nylon, Tuff Pack**	1	31.12

Kits Include: Bit, 50 Phillips Sheet Metal Screws, 50 Anchors, Display\* or Tuff Pack\*\*

## HEX HEAD SLOTTED CONCRETE ANCHORS

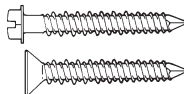

Vendor Code: **DOT**

Catalog Number	Description	Drill Size	Ctn. Qty.	Price per 100 pcs.
14H114	1/4" x 1-1/4"	3/16" x 3-1/2"	100	53.36
14H134	1/4" x 1-3/4"	3/16" x 3-1/2"	100	61.97
14H214	1/4" x 2-1/4"	3/16" x 4-1/2"	100	65.89
14H234	1/4" x 2-3/4"	3/16" x 4-1/2"	100	73.86

## HEX HEAD SLEEVE ANCHORS

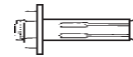

Vendor Code: **DOT**

Catalog Number	Description	Carton Quantity	Price per 100 pcs.
SA14138	1/4" x 1-3/8"	100	44.85
SA14214	1/4" x 2-1/4"	100	83.27
SA38300	3/8" x 3"	50	124.23

Uses Same Drill Size as Anchor Diameter.

## ZAMAC ANCHORS



Vendor Code: **DOT**

Catalog Number	Description	Carton Quantity	Price per 100 pcs.
ZA100	1/4" x 1"	100	57.12
ZA125	1/4" x 1-1/4"	100	64.58
ZA150	1/4" x 1-1/2"	100	68.12
ZA200	1/4" x 2"	100	94.96

Uses Same Drill Size as Anchor Diameter.

## NEW FLIPTOGGLE® KIT

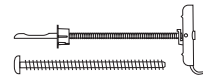

Vendor Code: **DOT**

Catalog Number	Description	Price Each
FTG316	10 3/16" - 24 x 2-1/2" Screws 10 3/16" FlipToggle	11.74
FTG14	10 1/4" - 20 x 2-1/2" Screws 10 1/4" FlipToggle	13.26

## ANCHOR KITS

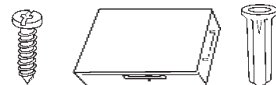

Vendor Code: **DOT**

Catalog Number	Description	Ctn. Qty.	Price Each
<b>PLASTIC</b>			
K6C0	Conical Anchor Kit with #10 Screws/Anchors*	1	16.28
K6HXT	Conical Anchor Kit with Hex, Phillip, and Slot Screws/Anchors**	1	14.77
2AK	Anchor Kit with #10 SM Screws (Phillip/Slotted) Masonry Drill Bit*	1	14.97
2AKHX	Anchor Kit with #10 SM Screws (Hex/Phillip/Slotted) Masonry Drill Bit*	1	14.77

Kits Include 100 Sheet Metal Screws, 100 Anchors, Carbide Masonry Drill, and Display\* or Tuff Pack\*\*

Tools, Terminals & Fasteners





PORTABLE LABEL PRINTERS

BMP@21-PLUS



The **BMP21PLUS** is an affordable label and wire printer designed for the tool box and can print die-cut or continuous labels up to .75" wide and up to 100 labels per day.

Vendor Code: **BRA**

Catalog Number	Description	Price Each
<b>BMP21PLUS</b>	BMP21-PLUS Label Printer (9.5" H x 4.5" W x 2.5" D)	132.03
<b>HEAT SHRINK SLEEVES</b>		
<b>M21187C342</b>	White, .187" Dia. x 7" L	73.72
<b>M21250C342</b>	White, .25" Dia. x 7" L	87.10

BMP@41 AND BMP@51



BMP41



BMP51

The **BMP41** Portable Label Printer is a mid-range handheld labeling solution that can print die-cut or continuous labels up to 1" wide and up to 250 labels per day.

The **BMP51** Portable Label Printer Offers three power options: AC Power (included), rechargeable Lithium Ion Battery (included), or 8 AA's (not included) and can print die-cut or continuous labels up to 1.5" wide and up to 500 labels per day.

Vendor Code: **BRA**

Catalog Number	Description	Price Each
<b>BMP41</b>	BMP41 Printer with Hardcase	349.00
<b>BMP51</b>	BMP51 Printer with Li-Ion Battery Pack and AC Adapter	638.40
<b>HEAT SHRINK SLEEVES</b>		
<b>M187075342</b>	.187" D x .75" W	58.00
	M Series B342 White .335" x 7, 1 Roll	74.86
<b>M1871342*</b>	.187" D x 1" W	82.64
<b>M250075342</b>	.25" D x .75", White	80.28
	M Series B342 White .439" x 7, 1 Roll	91.12
<b>M2501342*</b>	Sleeve, .25" D x 1" W	81.48

\*Only Compatible with BMP51

BMP@61



The **BMP61** handheld label printer is designed for efficient identification of wires, cables and components. It can easily import and export label files, lists and graphics to the printer through USB 2.0 port, USB flash drive or via Wi-Fi and can print die-cut or continuous labels up to 2" wide and up to 750 labels per day.

Vendor Code: **BRA**

Catalog Number	Description	Price Each
<b>BMP61</b>	BMP61 Label Printer (12.93" H x 4.22" W x 4.19" D)	828.57
<b>BMP61W</b>	BMP61 Label Printer with WiFi (12.93" H x 4.22" W x 4.19" D)	1033.54
<b>HEAT SHRINK SLEEVES</b>		
<b>PSPT1871WT</b>	.187" D x 1" W	79.20
<b>PSPT18715WT</b>	.187" D x 1.75" W	127.42
<b>PSPT1872WTR</b>	.187" D x 2" W	61.91
<b>PSPT2501WT</b>	.25" D x 1" W	115.04
<b>PSPT25015WT</b>	.25" D x 1.75" W	127.93
<b>PSPT2502WTR</b>	.25" D x 2" W	78.16

BMP@71

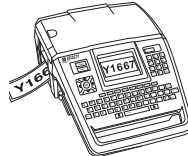

The portable **BMP71** label printer is designed to help create labels fast and efficiently with features such as built-in label design wizards, storage space for over 100,000 label files, and a large, full color graphic screen with print preview capabilities. It can print continuous and die-cut labels labels up to 2" wide and up to 1,000 labels per day.

Vendor Code: **BRA**

Catalog Number	Description	Price Each
<b>BMP71</b>	BMP71 Label Printer	1022.86
<b>HEAT SHRINK WIRE MARKING SLEEVES</b>		
<b>BM711871342</b>	.187" D x 1" W	624.36
<b>M711871342</b>	.187" D x 1" W	67.88
<b>BM712501342</b>	.25" D x 1" W	540.30
<b>M712501342</b>	.25" D x 1" W	95.50



INDUSTRIAL LABEL PRINTER

BRADYPRINTER I3300

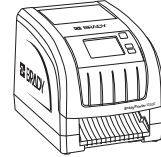

- No waste printing – with print smart technology, you get auto setup and calibration without throwing out blank labels
- Fast material changeovers – foolproof drop-in label rolls and ribbons snap into place for 20-second material changeovers
- Full-facility identification – complete all of your identification tasks, from wires, panels and products to safety and facility labels, with one convenient and efficient tool

Vendor Code: **BRA**

Catalog Number	Description	Price Each
<b>150640</b>	BradyPrinter i3300 with Brady Workstation Product and Wire ID Software Suite, (9.5" H x 9" W x 12" D)	2065.33
<b>HEAT SHRINKABLE WIRE MARKING SLEEVES</b>		
<b>B331872342</b>	B33, B342, White, .313 X 2" Fit	669.71
<b>B3318723422</b>	B33, B342, White, 0.313 X 2" Fit	669.72
<b>B332502342</b>	B33, B342, White, .415 X 2" Fit	597.70
<b>B3325023422</b>	B33, B342, White, .415" x 2" Fit	512.21



Tools, Terminals & Fasteners

K





**NEW**

## CRIMPER KIT

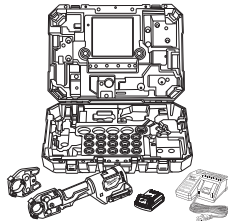

- LED light provides instant pressure verification
- Provides fasted crimp time in the industry
- PFM (Predictive Force Monitoring): ensures optimal pressure every time
- Receive instant pressure verification: green light delivers peace of mind
- In-line design and 350 degree head rotation: easy access in the tightest panels
- Hydraulic system is optimized for consistent performance from 0°F - 122°F
- Proprietary jaw alignment system: holds connector for instant alignment
- Tool records and stores every crimp made, One-Key enabled for professional report building
- Weather protected electronics keep dirt, dust and moisture out

Vendor Code: MIL

Catalog Number	Description	Price Each
2679750C	M18™ FORCE LOGIC™ 600 MCM Cu Crimper Kit with 750 MCM Expanded Jaw	4284.29

Includes: (1) 750 MCM Cu/Al Crimping Jaw for M18™ FORCE LOGIC™ 600 MCM Crimper, (1) 750 MCM Copper 6T U Style Die, (1) 600 MCM Copper U Style Die, (1) 500 MCM Copper U Style Die, (1) 400 MCM Copper U Style Die, (1) 350 MCM Copper U Style Die, (1) 250 MCM Copper U Style Die, (1) 4/0 Copper U Style Die, (1) 3/0 Copper U Style Die, (1) 2/0 Copper U Style Die, (1) 1/0 Copper U Style Die, (1) #1 Copper U Style Die, (1) #2 Copper U Style Die, (1) #4 Copper U Style Die, (1) #6 Copper U Style Die, (1) #8 Copper U Style Die, (2) M18™ REDLITHIUM™ CP2.0 Battery, (1) M18™ & M12™ Multi-Voltage Charger, and (1) Carrying Case

**NEW**

## CRIMPER



- Auto Distance Control Continuously Measures Distance & Pressure for Uniform Crimp Appearance Across All Sizes
- Lightest, In-Line Design & 180° Rotating Head for Easiest Alignment
- Easy Access Latch & One Handed Close, Frees-Up Second Hand to Hold Material
- Pre-Crimp Battery Check Automatically Ensures Enough Charge to Complete Each Crimp
- Fastest Dieless Crimper

Vendor Code: MIL

Catalog Number	Description	Price Each
287722	M18 FORCE LOGIC 750 MCM Dieless Crimper	4927.55

Includes: (1) M18™ FORCE LOGIC™ 750 MCM Dieless Crimper, (2) M18™ REDLITHIUM™ CP2.0 Battery, (1) M18™ & M12™ Multi-Voltage Charger, and (1) Carrying Case

**NEW**

## PIPE THREADER

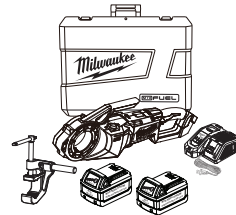

- AUTOSTOP™ kickback control prevents severe kickback
- Threads Faster than Corded
- Dedicated Support Arm enables threading without pipe stand
- One-Key™ technology allows for tracking, tool security, and inventory management
- Side grip and die head retention lock for no engagement with spinning die head

Vendor Code: MIL

Catalog Number	Description	Price Each
287422HD	M18 FUEL™ Pipe Threader w/ ONE-KEY™ Kit	2550.00

Includes: (1) M18 FUEL™ Pipe Threader w/ One-Key™, (2) M18 REDLITHIUM™ HIGH OUTPUT™ HD12.0 Battery Pack, (1) M18™ & M12™ Rapid Charger, (1) Threading Support Arm, and (1) Carrying Case

**NEW**

## ROTARY HAMMER KITS



271522

- FUEL™ Technology: Delivers faster than corded speed, corded durability, and all day work on one charge
- REDLITHIUM™ XC5.0 Battery Packs: Provide all day work on one charge, 20% more power and 2X more recharges than standard Lithium-Ion batteries
- AVS Anti-Vibration System: Minimizes vibration for maximum comfort
- POWERSTATE™ Brushless Motor: Provides 1.7 ft-lbs of impact energy, 0-1,400 RPM and 0-4,900 BPM
- REDLINK PLUS™ Intelligence: Integrates full-circle communication between tool, battery and charger to protect from overloading, overheating, and over-discharging

Vendor Code: MIL

Catalog Number	Description	Price Each
271222	M18 FUEL™ 1" SDS Plus Rotary Hammer Kit	608.45
271522	M18 FUEL™ 1-1/8" SDS Plus Rotary Hammer Kit	665.88

Includes: (2) Batteries, (1) Charger, (1) Side Handle, (1) Depth Rod, and (1) Carrying Case



Tools, Terminals & Fasteners





Tool Boxes · Organizers

**NEW**

**PACKOUT™ TOOL BOXES**

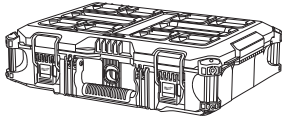

48228424

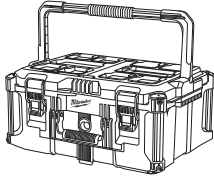

48228425

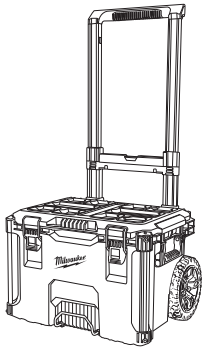

48228426

- IP65 Rated Weather Seal
- Metal Reinforced Corners
- Metal Reinforced Locking Point
- Interior Organizer Tray(s)
- Mounting Location for the ONE-KEY™ TICK™
- Heavy Duty Latches
- Reinforced Hinge
- Metal Reinforced Top Handle (48228425 only)
- Industrial Grade Extension Handle (48228426 only)
- 9" All-Terrain Wheels (48228426 only)

Vendor Code: MIL

Catalog Number	Description	H	W	L	Price Each
48228424	PACKOUT Tool Box	6.6"	16.1"	22.1"	72.86
48228425	PACKOUT Large Tool Box	11.3"	16.1"	22.1"	77.33
48228426	PACKOUT Rolling Tool Box	25.6"	22.1"	18.6"	125.33

**NEW**

**PACKOUT™ ORGANIZERS**

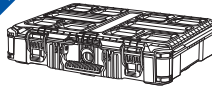

48228430

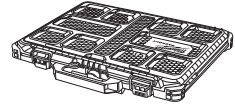

48228431

- IP65 Rated Weather Seal
- No-Travel Bins Seal Prevent Small Part Migration Between Bins
- Clear Top For Easy Identification Of Contents
- Integrated Center Slot For Long Bits and Blades
- Integrated screw slots on the back of the bins allow them to be mounted to the wall (48228430 only)
- Heavy Duty Latches
- Reinforced Hinge Includes 8 small and 2 large bins
- Slim Design for Organization of Small Items (48228431 only)

Vendor Code: MIL

Catalog Number	Description	H	W	L	Price Each
48228430	PACKOUT Organizer	4.61"	15"	19.76"	47.86
48228431	PACKOUT Low-Profile Organizer	2.52"	16.38"	19.76"	42.86

Tools, Terminals & Fasteners

K



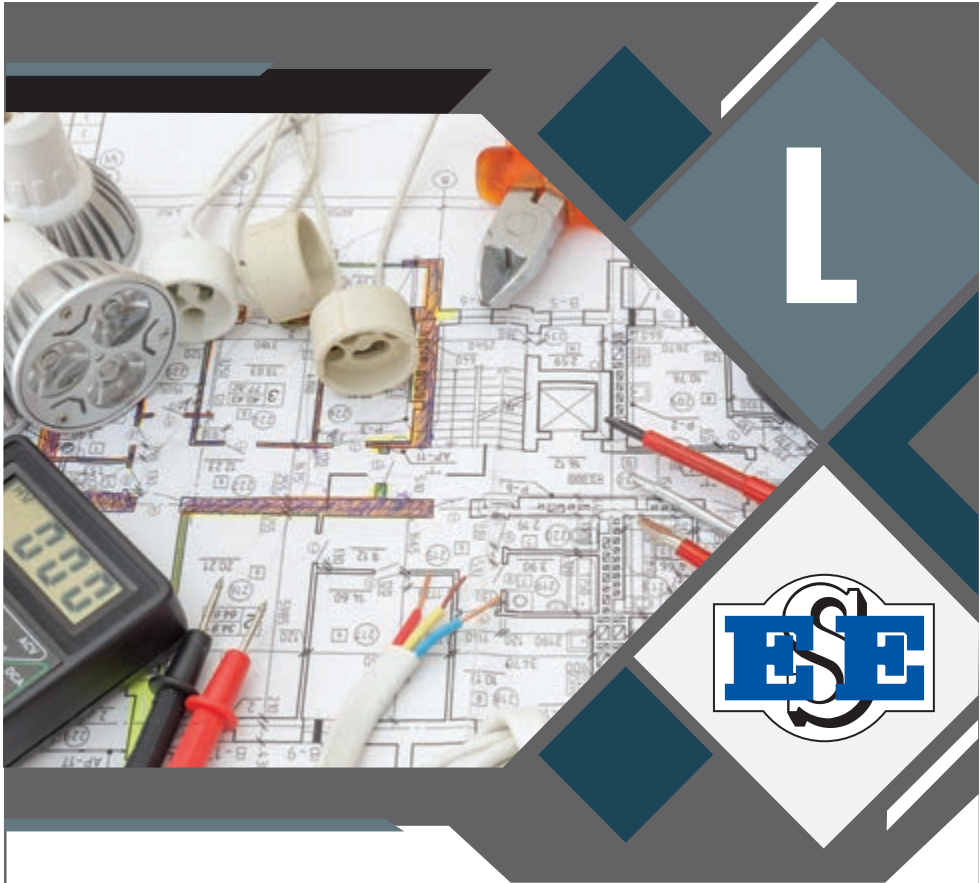

SECTION

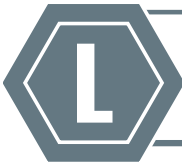

References

References





## References

## Useful Tables

Generators .....	L3-L5
Transformers.....	L6-L7
Conductors .....	L8-L10
Formulas & Conversions .....	L11
Motors.....	L11-L12
Relays .....	L13
Fuses .....	L13-L15
NEMA Blade Configurations.....	L16-L17
Data Cable Tips.....	L18
Bending Tips.....	L19
Lighting Guide .....	L20
NEMA Enclosure Types.....	L21
Pilot Device Configurations.....	L22
Lighting Control Code Requirements.....	L23
How to Identify a Counterfeit Breaker .....	L24
Power Defense Molded Case Circuit Breaker Replacement Guide .....	L25

## Elliott Electric Supply Store Information

Arizona .....	L26
Arkansas .....	L26-L27
Georgia .....	L27
Kansas .....	L27-L28
Louisiana.....	L28-L29
New Mexico .....	L29
Oklahoma .....	L29
Tennessee .....	L30
Texas.....	L30-L36

## Indexes

Product Index.....	L37-L45
Manufacturers Index .....	L46



## Appliances Powered by Generator

### HOW MUCH POWER DO YOU NEED FROM YOUR GENERATOR SYSTEM?

Eaton Electrical offers a complete line of emergency automatic standby generators for home or business that can be installed during new construction or retrofitted into existing structures. Residential emergency home standby generators are permanently installed outside (similar to an air-conditioning unit), supply electrical power to all pre-selected lights and appliances, and are powered by either natural gas or LPG. Models range from 7,000 to 40,000 watts. They work with a matched automatic transfer switch that responds within seconds when utility power shuts down, even when no one is home!

In addition, Eaton has introduced a feature packed Commercial Product Line that will revolutionize the generator industry. Ranging from 20 kW to 150 kW, these gensets provide value without sacrificing quality and cover the needs of most any larger residence, business or light commercial application. Single phase and three phase models available. Residential Home Standby emergency power generator can utilize the following special features.

#### UL-LISTED AUTOMATIC TRANSFER SWITCH

- Automatically signals the generator to produce emergency electrical power when utility fails and disconnects when utility power returns.
- Within seconds your generator is producing electrical power without you having to even flip a switch. You don't have to be home for your system to work!

#### AUTOMATIC EXERCISER

- Seven (7) day interval testing of the power generating system.
- You set the system to exercise at a prescribed time and day of the week. This allows you to verify that your system is in peak operating condition between utility failures.

#### CONVENIENT FUEL SUPPLY

- Operates on home/business natural gas or LP gas service.
- Provides you with potentially unlimited run time during extended utility power failures.
- On Board LED System Fault Indicators - low oil pressure, high engine temperature shutdown, overspeed / overcrank shutdown and system ready light (air-cooled models only).
- Aids in performance of servicing in the event of a system difficulty. Leads technician to a more specific area for troubleshooting purposes. Reduces service time.

#### OHVI® SINGLE OR TWIN-CYLINDER ENGINE

- Full-pressure lubrication system with automotive spin-on oil filter (air-cooled only).
- Finest lubrication technology available and provides instantaneous disbursement of lubricant to all engine parts. Easy change filter.

#### AUTOMATIC VOLTAGE REGULATOR

- Maintains constant voltage with varying loads.
- Eliminates voltage spikes and allows operation of sensitive electronic equipment.

#### MAINTENANCE FRIENDLY

- Air-cooled models include a hinged top and removable front panel. Liquid-cooled models feature large removable enclosure doors.
- Provides easy and quick access to all maintenance and service parts. Reduces preventative maintenance or repair time.

Appliances That Can Be Powered*	Generator Kilowatts			
	8 kW	14 kW	17 kW	20 kW
Furnace Fan	✓	✓	✓	✓
Refrigerator	✓	✓	✓	✓
Four 100W Lamps	✓	✓	✓	✓
Water Pump	✓	✓	✓	✓
Sump Pump	✓	✓	✓	✓
Stereo	✓	✓	✓	✓
Color Television	✓	✓	✓	✓
Coffee Maker	✓	✓	✓	✓
Hair Dryer	✓	✓	✓	✓
Clock Radio	✓	✓	✓	✓
Computer	✓	✓	✓	✓
Deep Freezer	✓	✓	✓	✓
Microwave		✓	✓	✓
Electric Range (1 element)		✓	✓	✓
Electric Blanket		✓	✓	✓
Attic Fan		✓	✓	✓
Garage Door Opener (1/4 HP)		✓	✓	✓
Security System		✓	✓	✓
Washing Machine		✓	✓	✓
Clothes Dryer		✓	✓	✓
Dishwasher		✓	✓	✓
Water Heater			✓	✓
Vacuum Cleaner			✓	✓
Toaster			✓	✓
Humidifier			✓	✓
Whirlpool Bath			✓	✓
Air Conditioner			✓	✓
Office Lighting				✓
Coper and Fax Machines				✓
Telephone System				✓
Computer Network System				✓
Central Air Conditioner				✓



References

This chart is for estimating purposes only. Calculations are based on estimates of average wattage in each appliance type. Some appliances may be substituted for others. Appliances may not be able to run simultaneously.



## Generator Fuel Pipe Sizing Guide

## NATURAL GAS MAXIMUM PIPE RUN (IN FEET)

Kilowatts (kW)	Pipe Size (Diameter)						
	3/4"	1"	1-1/4"	1-1/2"	2"	2-1/2"	3"
7 – 8	55	200	820				
10	20	85	370	800			
13 – 14	10	50	245	545			
16 – 17		40	190	425			
20		20	130	305	945		
22		15	115	260	799		
25		10	95	220	739		
27			85	203	552		
30			60	147	565		
35 – 36			35	95	370	915	
40			25	75	315	790	
45			15	60	260	650	
48				50	230	585	
50				50	220	560	
60				25	145	390	1185
70				5	75	225	710
80					65	195	630
100					40	140	460
130						50	215
150						30	150

## LP

- LPG: 8.55 ft<sup>3</sup>/lb., 4.24 lbs./gal., 2500 btu/ft<sup>3</sup>
- LPG: 36.3 ft<sup>3</sup> = 1 gal.

## NATURAL GAS

- 1 cubic foot = 1,000 BTU.
- 1 therm = 100,000 BTU.
- Gas consumption = 13,000 – 16,000 BTU per kW/hr.

## PRESSURE

- 1 inch mercury = 13.61 inches water column.
- 1 inch Water Column = 0.036 psi.
- 5-14 inches water column = 0.18 psi to 0.50 psi.

## NOTE

- Pipe sizing is based on 0.5" H<sub>2</sub>O pressure drop
- Sizing includes a nominal number of elbows and tees.
- Please verify adequate service and meter sizing.

## LP VAPOR MAXIMUM PIPE RUN (IN FEET)

Kilowatts (kW)	Pipe Size (Diameter)						
	3/4"	1"	1-1/4"	1-1/2"	2"	2-1/2"	3"
7 – 8	165	570					
10	70	255	1000				
13 – 14	45	170	690				
16 – 17	25	130	540				
20	15	115	480				
22		85	365				
25		60	275	605			
27		55	260	575			
30		40	195	435			
35 – 36		20	125	290	1030		
40		15	107	250	890		
45			82	195	725		
48			70	165	620		
50			70	160	610		
60			45	115	445	1095	
70			20	60	260	660	
80			15	50	230	590	
100				30	165	430	1305
130					70	205	660
150					45	150	490



## Generator LP Vapor Tank Sizing Guide

### VAPOR WITHDRAWAL

Tank Capacity Total (gallons)	Tank Capacity Usable (gallons)	Minimum Temperature (°F)	Tank Capacity (BTU/hour)	Dimensions (inches)		
				Length	Diameter	Overall Height
120	72	40	246,240	57	24	33
		20	164,140			
		0	82,080			
150	90	40	293,760	68	24	33
		20	195,840			
		0	97,920			
250	150	40	507,600	94	30	39
		20	338,400			
		0	169,200			
325	195	40	642,600	119	30	39
		20	428,400			
		0	214,200			
500	300	40	792,540	119	37	46
		20	528,360			
		0	264,180			
850	510	40	1,217,700	165	41	50
		20	811,800			
		0	405,900			
1000	600	40	1,416,960	192	41	50
		20	944,640			
		0	472,320			

### ESTIMATED FUEL USAGE

Load (kW)	BTU/Hour	LP (Gal/hr)	NG (ft <sup>3</sup> /hr)	NG (Therms/hr)
5	110,000	1.2	110	1.1
10	176,400	2.0	156	1.6
15	231,800	2.5	220	2.2
20	267,100	2.8	262	2.6
25	352,800	3.8	316	3.2
30	418,300	4.5	417	4.2
35	467,400	5.1	485	4.8
40	550,000	6.1	550	5.5
50	675,000	7.5	675	6.7
60	836,600	9.0	862	8.6
70	1,035,700	11.0	1,020	10.2
80	1,170,000	12.7	1,154	11.5
90	1,200,000	13.0	1,200	12.0
100	1,280,000	13.8	1,260	12.6
110	1,550,000	17.1	1,550	15.5
120	1,675,000	18.5	1,675	16.7
130	1,800,000	19.5	1,786	17.8
140	1,925,000	21.3	1,925	19.2
150	2,050,000	22.7	2,050	20.5
200	2,800,000	30.9	2,800	28.0
300	4,100,000	45.3	4,100	49.0

Operating Cost Per Hour = NG Therms/hour x Cost of NG Therm



### GAS REQUIRED FOR COMMON APPLIANCES

Appliance	Approximate Input (BTU/hr)
<b>WARM AIR FURNACE</b>	
Single Family	100,000
Multi-family, Per Unit	60,000
<b>HYDRONIC BOILER, SPACE HEATING</b>	
Single Family	100,000
Multi-family, Per Unit	60,000
<b>HYDRONIC BOILER, SPACE AND WATER HEATING</b>	
Single Family	120,000
Multi-family, Per Unit	75,000
<b>RANGES</b>	
Free Standing, Domestic	65,000
Built-in Oven or Broiler Unit, Domestic	25,000
Built-in Top Unit, Domestic	40,000
<b>WATER HEATER, AUTOMATIC STORAGE</b>	
30 - 40 Gallon Tank	35,000
50 Gallon Tank	50,000
<b>WATER HEATER, INSTANTANEOUS</b>	
2 Gallons Per Minute	142,800
4 Gallons Per Minute	285,000
6 Gallons Per Minute	428,000
<b>OTHER APPLIANCES</b>	
Water Heater, Circulating or Side-arm, Domestic	35,000
Refrigerator	3,000
Clothes Dryer, Type 1 (Domestic)	35,000
Gas Fireplace, Direct Vent	40,000
Gas Log	80,000
Barbecue	40,000
Gas Light	2,500
Incinerator, Domestic	35,000

References



## Control Transformer Selection

### SELECTION PROCEDURE:

The following steps will assure that the secondary voltage delivered by your transformer will be either 85%, 90% or 95% of the nameplate secondary voltage under maximum inrush conditions, at rated input voltage.

#### STEP 1

Calculate the total SEALED (steady state) VA load of your control circuit. This is done by adding the continuous VA requirements of the maximum number of components that will be energized at any given time, including non-inductive as well as inductive components. For Sealed VA data see chart below.

#### STEP 2

Calculate the PEAK INRUSH VA of your control circuit. First, analyze the sequence of operation of all components. Then add together the inrush VA ratings of the components that will be energized simultaneously. Next, determine the peak—or maximum simultaneous—inrush VA load that the transformer will “see.” The VA requirements for indicating lights, timers and other non-inductive components which do not have an inrush VA also should be included since they will present a load to the transformer at the time of maximum inrush.

#### STEP 3

Calculate the TRANSFORMER SELECTION INRUSH VA. Use the following formula:

$$\text{Selection Inrush VA} = \sqrt{(\text{VA Sealed})^2 + (\text{VA Inrush})^2}$$

NOTE: Transformer Selection inrush VA also can be determined by adding the inrush VA and sealed VA arithmetically, but this usually results in an oversized transformer.

#### STEP 4

Determine the correct transformer NAMEPLATE VA Rating. Refer to the Inrush/Regulation Data table: if the line supply to the transformer is fairly stable (does not vary more than 5%), use the 90% secondary voltage column—the 90% column is most commonly used. If the line supply voltage varies up to 10%, use the 95% voltage regulation column. To determine the correct VA transformer rating, go down the column until you arrive at the inrush VA rating closest to, but not less than, the Transformer Selection Inrush VA calculated in Step 3. The left hand column of the table will give the corresponding transformer NAMEPLATE VA RATING.

NOTE: When evaluating supply-line stability, remember that supply-line voltage drop frequently is associated with motor-starting inrush current. When motors and motor controls are connected to a common feeder, the controls will experience a momentary voltage dip when the motor starts. This reduces the control transformer voltage supplied to the motor starting contactor and may cause the contactor to chatter or drop out.

### INRUSH / REGULATION DATA

Transformer VA Rating at 55°C	Inrush VA — 40% Power Factor		
	At 95% Secondary Voltage	At 90% Secondary Voltage	At 85% Secondary Voltage
60	137	185	227
95	242	329	409
105	294	407	512
180	592	842	1071
225	929	1312	1663
275	1271	1801	2288
320	1581	2224	2816
380	2124	3048	3895
550	3196	4604	5896
850	5500	7914	10141
1100	8382	12067	15477
1500	11100	16066	21032
2000	21820	24356	41100
3000	29123	32770	59997
5000	74595	111000	145000
7500	104000	162000	219000
10000	111000	166000	237000

### COMPONENT VA TABLES

Device	Inrush			Sealed		
	VAR	Watts	VA	VAR	Watts	VA
<b>FREEDOM SERIES STARTERS AND CONTACTORS: AE16, AN16, AE56, AN56, CE15, CN35, CE55, CN55, MCE15</b>						
IEC Sizes A – C	64	49	80	7.1	2.4	7.5
IEC Sizes D – F	78	65	100	9.2	3.1	10.0
IEC Sizes G – K	210	95	230	27.0	7.8	28.0
IEC Sizes L – N	374	112	390	48.0	13.0	49.8
IEC Sizes P – S	1132	240	1158	96.0	27.2	100.0
NEMA Size 00	64	49	80	7.1	2.4	7.5
NEMA Size 0	78	65	100	9.2	3.1	10.0
NEMA Sizes 1 – 2	210	95	230	27.0	7.8	28.0
NEMA Size 3	374	112	390	48.0	13.0	49.8
NEMA Sizes 4 – 5	1132	240	1158	96.0	27.2	100.0
NEMA Size 6	868	1345	1600	11.0	21.0	25.0
<b>CITATION CONTACTORS AND STARTERS: A10, A50, B10, B50, C10, C50</b>						
Size 00: Series C1	64	49	80	7.1	2.4	7.5
Sizes 0 – 1	81.5	63	103	18.7	7.0	20.0
Size 2	115	80	140	22.0	9.3	24.0
Size 3	374	112	390	48.0	13.0	49.8
Sizes 4 – 5	1132	240	1158	96.0	27.2	100.0
Size 6: Series C1	868	1345	1600	11.0	21.0	25.0
Size 7: Series B1						
Interposing Relay	29	68	74	5.1	6.8	8.5
Main Contactor	6275	2989	6950	170.0	60.0	180.0
Size 8: Series B1						
Main Coil	1262	2100	2450	56.0	50.0	75.0

Device	Inrush			Sealed		
	VAR	Watts	VA	VAR	Watts	VA
<b>RELAYS</b>						
Type AA (1–2 Pole)	18.0	8.5	20.0	8.0	6.6	11.0
Type D15	64.0	49.0	80.0	7.1	2.4	7.5
Type M (2–12 Pole)	122.0	95.0	155.0	20.0	9.0	22.0
Type M Latch Coil	36.5	18.5	41.0	13.0	11.0	17.0
Type MRD	–	168.0	–	–	13.2	13.2
Type MRD Ltc. Coil	–	21.6	–	–	21.6	–
Type R	–	6.0	6.0	–	6.0	6.0
Type RM – Set	–	–	–	–	3.5	3.5
Type RM – Release	–	–	–	–	3.1	3.1
Type TF	3.0	3.0	4.0	3.0	3.0	4.0
Type TH	4.0	4.0	5.0	4.0	4.0	5.0
<b>TIMERS</b>						
Type D80	60.0	67.0	90.0	18.0	6.0	19.0
Type D80 with Installed Contacts	89.0	95.0	130.0	20.0	7.0	21.0







## Buck / Boost Transformers · Transformer Full Load Current

Buck-Boost Transformers are small single phase isolation transformers that will reduce (Buck) or raise (Boost) line voltage when connected as an Autotransformer. The most common application is Boosting 208 to 230V. Two or three may be banked for three phase application where the neutral is available from the input. Much smaller transformers may be used in Buck-Boost applications, since the size of the transformer is roughly proportional to the change in voltage.  
 i.e.: A 10 kVA load at 240V can be increased to 264V, a 10% change can be achieved with a 1 kVA transformer.

### VOLTAGE CHANGE TABLE

Rating	Reference Diagrams Below for Characteristics							
	A1	A2	B1	B2	C1	C2	D1	D2
120/240 x 12/24	1.10	0.90	1.20	0.80	1.05	0.95	1.10	0.90
120/240 x 16/32	1.13	0.87	1.27	0.77	1.07	0.93	1.13	0.87
240/480 x 24/48	1.10	0.90	1.20	0.80	1.05	0.95	1.10	0.90

Multiply Input Voltage by multiplier in Voltage Change Table for output voltage.

### TRANSFORMER MULTIPLIER TABLE

Rating	Reference Diagrams Below for Characteristics							
	A1	A2	B1	B2	C1	C2	D1	D2
120/240 x 12/24	0.10	0.11	0.20	0.24	0.05	0.05	0.10	0.11
120/240 x 16/32	0.13	0.15	0.27	0.34	0.07	0.07	0.13	0.15
240/480 x 24/48	0.10	0.11	0.20	0.24	0.05	0.05	0.10	0.11

Multiply Load by multiplier in Transformer Multiplier Table for approximate transformer size.

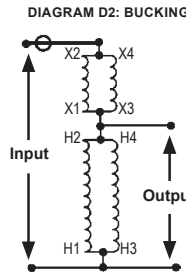
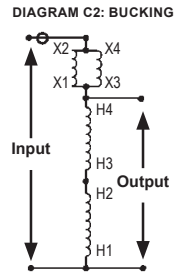
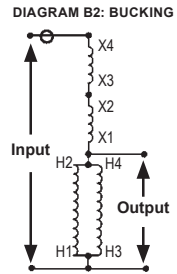
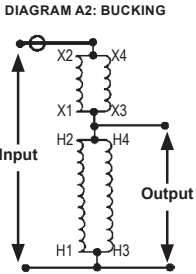
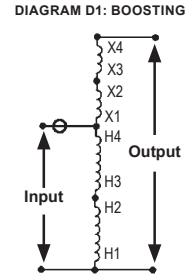
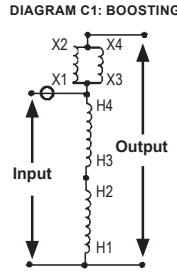
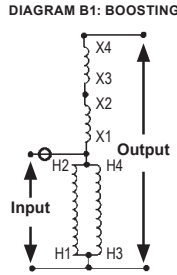
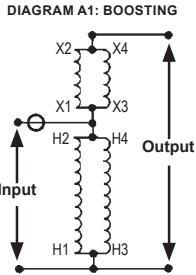

### TRANSFORMER FULL LOAD CURRENT TABLES

#### SINGLE PHASE

kVA Rating	120V	208V	240V	277V	480V	600V
0.050	0.42	0.24	0.21	0.18	0.10	0.08
0.100	0.83	0.48	0.42	0.36	0.21	0.17
0.150	1.25	0.72	0.63	0.54	0.31	0.25
0.250	2.08	1.20	1.04	0.90	0.52	0.42
0.500	4.17	2.40	2.18	1.81	1.04	0.83
0.750	6.25	3.61	3.13	2.71	1.56	1.25
1.00	8.33	4.81	4.17	3.61	2.08	1.67
1.50	12.50	7.21	6.25	5.42	3.13	2.50
2.00	16.67	9.62	8.33	7.22	4.17	3.33
3.00	25.00	14.42	12.50	10.3	6.25	5.00
5.00	41.67	24.04	20.83	18.05	10.42	8.33
7.50	62.50	36.06	31.25	27.08	15.63	12.50
10.0	83.33	48.08	41.67	36.10	20.83	16.67
15.0	125.00	72.12	62.50	54.15	31.25	25.00
25.0	208.33	120.19	104.17	90.25	52.08	41.67

#### THREE PHASE

kVA Rating	208V	240V	480V	600V
3.0	8.34	7.23	3.61	2.89
9.0	25.01	21.68	10.84	8.67
15.0	41.69	36.13	18.06	14.45
30.0	83.37	72.25	36.13	28.90
45.0	125.06	108.38	54.19	43.35
75.0	208.43	180.64	90.32	72.25
112.5	312.64	271.95	135.48	108.38

$$\text{Three Phase kVA} = \frac{\text{Volts} \times \text{Amps} \times 1.73}{1000}$$

$$\text{Single Phase kVA} = \frac{\text{Volts} \times \text{Amps}}{1000}$$



**AMPACITIES OF INSULATED CONDUCTORS WITH NOT MORE THAN THREE CURRENT-CARRYING CONDUCTORS IN RACEWAY, CABLE OR EARTH (DIRECTLY BURIED)**

TABLE 310-16, 2020 N.E.C.

Wire Size	Copper			Aluminum		
	60°C	75°C	90°C	60°C	75°C	90°C
	TW, UF	THW, THWN, THHW, USE	THHN, TFFN	TW, UF	THW, THWN, THHW, USE	THHN, TFFN
18 AWG*	—	—	14	—	—	—
16 AWG*	—	—	18	—	—	—
14 AWG*	15	20	25	—	—	—
12 AWG*	20	25	30	15	20	25
10 AWG*	30	35	40	25	30	35
8 AWG	40	50	55	35	40	45
6 AWG	55	65	75	40	50	55
4 AWG	70	85	95	55	65	75
3 AWG	85	100	115	65	75	85
2 AWG	95	115	130	75	90	100
1 AWG	110	130	145	85	100	115
1/0 AWG	125	150	170	100	120	135
2/0 AWG	145	175	195	115	135	150
3/0 AWG	165	200	225	130	155	175
4/0 AWG	195	230	260	150	180	205
250 MCM	215	255	290	170	205	230
300 MCM	240	285	320	195	230	260
350 MCM	260	310	350	210	250	280
400 MCM	280	335	380	225	270	305
500 MCM	320	380	430	260	310	350
600 MCM	350	420	475	285	340	385
700 MCM	385	460	520	315	375	425
750 MCM	400	475	535	320	385	435

Section 310.15(B) shall be referenced for ampacity correction factors when the ambient temperature is other than 30°C (86°F).

Section 310.15(C)(1) shall be referenced for more than three current-carrying conductors. (see below)

Section 310.16 shall be referenced for conditions of use.

\*Section 240.4(D) shall be referenced for conductor overcurrent protection limitations, except as modified elsewhere in the Code.

**ADJUSTMENT FACTORS FOR MORE THAN THREE CURRENT-CARRYING CONDUCTORS**

TABLE 310-15(C)(1), 2020 N.E.C.

Number of Conductors in a Raceway	Percent of Total Value
4 – 6	80
7 – 9	70
10 – 20	50
21 – 30	45
31 – 40	40
41 or Above	35

**AMBIENT TEMPERATURE CORRECTION FACTORS BASED ON 30°C (86°F)**

TABLE 310-15(B)(1), 2020 N.E.C.

Ambient Temperature	Temperature Rating of Conductor		
	60°C	75°C	90°C
10 or less	1.29	1.20	1.15
11 – 15	1.22	1.15	1.12
16 – 20	1.15	1.11	1.08
21 – 25	1.08	1.05	1.04
26 – 30	1.00	1.00	1.00
31 – 35	0.91	0.94	0.96
36 – 40	0.82	0.88	0.91
41 – 45	0.71	0.82	0.87
46 – 50	0.58	0.75	0.82
51 – 55	0.41	0.67	0.76
56 – 60	—	0.58	0.71
61 – 65	—	0.47	0.65
66 – 70	—	0.33	0.58
71 – 75	—	—	0.50
76 – 80	—	—	0.41
81 – 85	—	—	0.29

**VOLTAGE DROP TABLE**

Voltage Drop = $\frac{\text{Factor} \times \text{Amps} \times \text{Feet}}{100}$		
Copper Conductor: 80% Power Factor		
Wire Size	Single Phase	Three Phase
14 AWG	0.4762	0.4167
12 AWG	0.3125	0.2632
10 AWG	0.1961	0.1677
8 AWG	0.1250	0.1087
6 AWG	0.0833	0.0714
4 AWG	0.0538	0.0463
3 AWG	0.0431	0.0379
2 AWG	0.0370	0.0323
1 AWG	0.0323	0.0278
1/0 AWG	0.0269	0.0231
2/0 AWG	0.0222	0.0196
3/0 AWG	0.0190	0.0163
4/0 AWG	0.0161	0.0139
250 MCM	0.0147	0.0128
300 MCM	0.0131	0.0114
350 MCM	0.0121	0.0106
400 MCM	0.0115	0.0091
500 MCM	0.0101	0.0088

**SINGLE-PHASE DWELLING SERVICES AND FEEDERS**

TABLE 310-12, 2020 N.E.C.

Copper (AWG)	Aluminum (AWG)	Service Amps
4	2	100
3	1	110
2	1/0	125
1	2/0	150
1/0	3/0	175
2/0	4/0	200



## Conduit Fill Table

### MAXIMUM NUMBER OF REGULAR CONDUCTORS IN EMT, IMC OR RMC

DATA EXTRACTED FROM TABLE C.1, TABLE C.4 AND TABLE C.9 IN 2020 N.E.C.

Conduit Trade Size in Inches	Wire Size (THWN, THHN)																				
	AWG										MCM										
	14	12	10	8	6	4	3	2	1	1/0	2/0	3/0	4/0	250	300	350	400	500	600	700	750
1/2	EMT	12	9	5	3	2	1	1	1	1	1	-	-	-	-	-	-	-	-	-	-
	IMC	14	10	6	3	2	1	1	1	1	1	1	-	-	-	-	-	-	-	-	-
	GALV	13	9	6	3	2	1	1	1	1	1	1	-	-	-	-	-	-	-	-	-
3/4	EMT	22	16	10	6	4	2	1	1	1	1	1	1	1	-	-	-	-	-	-	-
	IMC	24	17	11	6	4	3	2	1	1	1	1	1	1	-	-	-	-	-	-	-
	GALV	22	16	10	6	4	2	1	1	1	1	1	1	1	-	-	-	-	-	-	-
1	EMT	35	26	16	9	7	4	3	3	1	1	1	1	1	1	1	1	-	-	-	-
	IMC	39	29	18	10	7	4	4	3	2	1	1	1	1	1	1	1	1	-	-	-
	GALV	36	26	17	9	7	4	3	3	1	1	1	1	1	1	1	1	1	-	-	-
1 1/4	EMT	61	45	28	16	12	7	6	5	4	3	2	1	1	1	1	1	1	1	1	-
	IMC	68	49	31	18	13	8	6	5	4	3	3	2	1	1	1	1	1	1	1	1
	GALV	63	46	29	16	12	7	6	5	4	3	2	1	1	1	1	1	1	1	1	-
1 1/2	EMT	84	61	38	22	16	10	8	7	5	4	3	3	2	1	1	1	1	1	1	1
	IMC	91	67	42	24	17	11	9	7	5	4	4	3	2	1	1	1	1	1	1	1
	GALV	85	62	39	22	16	10	8	7	5	4	3	3	2	1	1	1	1	1	1	1
2	EMT	138	101	63	36	26	16	13	11	8	7	6	5	4	3	3	2	1	1	1	1
	IMC	149	109	69	39	28	17	15	12	9	8	6	5	4	3	3	2	2	1	1	1
	GALV	140	102	64	37	27	16	14	11	8	7	6	5	4	3	3	2	2	1	1	1
2 1/2	EMT	241	176	111	64	46	28	24	20	15	12	10	8	7	6	5	4	4	3	2	2
	IMC	211	154	97	56	40	25	21	17	13	11	9	7	6	5	4	4	3	3	2	1
	GALV	200	146	92	53	38	23	20	17	12	10	8	7	6	5	4	3	3	2	1	1
3	EMT	364	266	167	96	69	43	36	30	22	19	16	13	11	9	7	6	6	5	4	3
	IMC	326	238	150	86	62	38	32	27	20	17	14	12	9	8	7	6	5	4	3	3
	GALV	309	225	142	82	59	36	31	26	19	16	13	11	9	7	6	5	5	4	3	3
3 1/2	EMT	476	347	219	126	91	56	47	40	29	25	20	17	14	11	10	9	8	6	5	4
	IMC	436	318	200	115	83	51	43	36	27	23	19	16	13	10	9	8	7	6	5	4
	GALV	412	301	189	109	79	48	41	34	25	21	18	15	12	10	8	7	7	5	4	4
4	EMT	608	443	279	161	116	71	60	51	37	32	26	22	18	15	13	11	10	8	7	6
	IMC	562	410	258	149	107	66	56	47	35	29	24	20	17	13	12	10	9	7	6	5
	GALV	531	387	244	140	101	62	53	44	33	27	23	19	16	13	11	10	8	7	6	5

Please refer to the 2020 N.E.C. for more information of the following conduit fill tables. Table C.2 for EMT, Table C.3 for FMC, Table C.5 for LFNC-A, Table C.6 for LFNC-B, Table C.7 for LFNC-C, Table C.8 for LFMC, Table C.10 for Rigid PVC Schedule 80, Table C.11 for Rigid PVC Schedule 40, Table C.12 for Type A PVC, and Table C.13 for Type EB PVC.





Conduit Fill Table for Compact Conductors

**Compact Stranding**

A stranding configuration with concentric strands in which each layer is passed through a compacting die to reduce the conductor diameter by approximately 10%

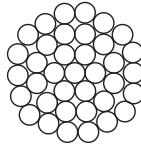

Regular Conductor

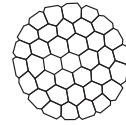

Compacted Conductor

Compact Stranding is typical of Aluminum Conductors which allows more conductors in the same size conduit.

**MAXIMUM NUMBER OF COMPACTED CONDUCTORS IN EMT, IMC OR RMC**

DATA EXTRACTED FROM TABLE C.1(A), TABLE C.4(A) AND TABLE C.9(A) IN 2020 N.E.C.

Conduit Trade Size in Inches		Wire Size (Aluminum XHHW, THHN)															
		AWG								MCM							
		8	6	4	2	1	1/0	2/0	3/0	4/0	250	300	350	400	500	600	700
1/2	EMT	-	2	1	1	1	1	1	-	-	-	-	-	-	-	-	-
	IMC	-	3	1	1	1	1	1	-	-	-	-	-	-	-	-	-
	GALV	-	2	1	1	1	1	1	-	-	-	-	-	-	-	-	-
3/4	EMT	-	4	3	1	1	1	1	1	1	1	-	-	-	-	-	-
	IMC	-	5	3	1	1	1	1	1	1	1	-	-	-	-	-	-
	GALV	-	5	3	1	1	1	1	1	1	1	-	-	-	-	-	-
1	EMT	-	7	4	3	2	1	1	1	1	1	1	1	1	-	-	-
	IMC	-	8	5	3	3	2	1	1	1	1	1	1	1	1	-	-
	GALV	-	8	5	3	2	1	1	1	1	1	1	1	1	1	-	-
1 1/4	EMT	-	13	8	6	4	3	3	2	1	1	1	1	1	1	1	1
	IMC	-	14	9	6	5	4	3	3	2	1	1	1	1	1	1	1
	GALV	-	13	8	6	4	4	3	2	1	1	1	1	1	1	1	1
1 1/2	EMT	-	18	11	8	6	5	4	3	3	1	1	1	1	1	1	1
	IMC	-	19	12	8	6	5	4	4	3	2	1	1	1	1	1	1
	GALV	-	18	11	8	6	5	4	3	3	2	1	1	1	1	1	1
2	EMT	-	29	18	13	10	8	7	6	5	4	3	3	2	1	1	1
	IMC	-	32	20	14	10	9	7	6	5	4	3	3	2	2	1	1
	GALV	-	30	18	13	10	8	7	6	5	4	3	3	2	1	1	1
2 1/2	EMT	-	52	32	23	17	14	12	10	8	6	5	5	4	4	3	2
	IMC	-	45	28	20	15	13	10	9	7	6	5	4	4	3	2	2
	GALV	-	43	26	19	14	12	10	8	7	5	4	4	3	3	2	1
3	EMT	-	78	48	34	26	22	18	15	12	10	8	7	6	5	4	4
	IMC	-	70	43	31	23	20	16	14	11	9	7	7	6	5	4	3
	GALV	-	66	41	29	22	19	15	13	10	8	7	6	5	5	4	3
3 1/2	EMT	-	102	63	45	34	29	24	20	16	13	11	10	9	7	6	5
	IMC	-	93	58	41	31	26	22	18	15	12	10	9	8	7	5	5
	GALV	-	88	55	39	29	25	21	17	14	11	10	8	7	6	5	4
4	EMT	-	130	81	58	43	37	30	25	21	16	14	12	11	9	7	7
	IMC	-	120	74	53	40	34	28	24	19	15	13	11	10	9	7	6
	GALV	-	114	70	50	38	32	26	22	18	14	12	11	10	8	6	6

Please refer to the 2020 N.E.C. for more information of the following compacted conductor conduit fill tables. Table C.2(A) for ENT, Table C.3(A) for FMC, Table C.5(A) for LFNC-A, Table C.6(A) for LFNC-B, Table C.7(A) for LFNC-C, Table C.8(A) for LFMC, Table C.10(A) for Rigid PVC Schedule 80, Table C.11(A) for Rigid PVC Schedule 40, Table C.12(A) for Type A PVC, and Table C.13(A) for Type EB PVC.



### TEMPERATURE CONVERSION TABLE

°C	°F	°C	°F	°C	°F	°C	°F
0	32.0	$^{\circ}\text{F} = (9/5 \times ^{\circ}\text{C}) + 32$		$^{\circ}\text{C} = 5/9 \times (^{\circ}\text{F} - 32)$		$^{\circ}\text{K} = ^{\circ}\text{C} + 273.15$	
1	33.8	26	78.8	51	123.8	76	168.8
2	35.6	27	80.6	52	125.6	77	170.6
3	37.4	28	82.4	53	127.4	78	172.4
4	39.2	29	84.2	54	129.2	79	174.2
5	41.0	30	86.0	55	131.0	80	176.0
6	42.8	31	87.8	56	132.8	81	177.8
7	44.6	32	89.6	57	134.6	82	179.6
8	46.4	33	91.4	58	136.4	83	181.4
9	48.2	34	93.2	59	138.2	84	183.2
10	50.0	35	95.0	60	140.0	85	185.0
11	51.8	36	96.8	61	141.8	86	186.8
12	53.6	37	98.6	62	143.6	87	188.6
13	55.4	38	100.4	63	145.4	88	190.4
14	57.2	39	102.2	64	147.2	89	192.2
15	59.0	40	104.0	65	149.0	90	194.0
16	60.8	41	105.8	66	150.8	91	195.8
17	62.6	42	107.6	67	152.6	92	197.6
18	64.4	43	109.4	68	154.4	93	199.4
19	66.2	44	111.2	69	156.2	94	201.2
20	68.0	45	113.0	70	158.0	95	203.0
21	69.8	46	114.8	71	159.8	96	204.8
22	71.6	47	116.6	72	161.6	97	206.6
23	73.4	48	118.4	73	163.4	98	208.4
24	75.2	49	120.2	74	165.2	99	210.2
25	77.0	50	122.0	75	167.0	100	212.0

### FULL LOAD CURRENT IN AMPERES SINGLE-PHASE, ALTERNATING-CURRENT MOTORS

TABLE 430.248, 2020 N.E.C.

Horsepower (HP)	115V	200V	208V	230V
<b>1/6</b>	4.4	2.5	2.4	2.2
<b>1/4</b>	5.8	3.3	3.2	2.9
<b>1/3</b>	7.2	4.1	4.0	3.6
<b>1/2</b>	9.8	5.6	5.4	4.9
<b>3/4</b>	13.8	7.9	7.6	6.9
<b>1</b>	16.0	9.2	8.8	8.0
<b>1-1/2</b>	20.0	11.5	11.0	10.0
<b>2</b>	24.0	13.8	13.2	12.0
<b>3</b>	34.0	19.6	18.7	17.0
<b>5</b>	56.0	32.2	30.8	28.0
<b>7-1/2</b>	80.0	46.0	44.0	40.0
<b>10</b>	100.0	57.5	55.0	50.0

The voltages listed are rated motor voltages. The listed currents are for system voltage ranges of 110 to 120 and 220 to 240.

### FULL LOAD CURRENT IN AMPERES, DIRECT-CURRENT MOTORS

TABLE 430.247, 2020 N.E.C.

HP	90V	120V	180V	240V	500V	550V
<b>1/4</b>	4.0	3.1	2.0	1.6	--	--
<b>1/3</b>	5.2	4.1	2.6	2.0	--	--
<b>1/2</b>	6.8	5.4	3.4	2.7	--	--
<b>3/4</b>	9.6	7.6	4.8	3.8	--	--
<b>1</b>	12.2	9.5	6.1	4.7	--	--
<b>1-1/2</b>	--	13.2	8.3	6.6	--	--
<b>2</b>	--	17.0	10.8	8.5	--	--
<b>3</b>	--	25.0	16.0	12.2	--	--
<b>5</b>	--	40.0	27.0	20.0	--	--
<b>7-1/2</b>	--	58.0	--	29.0	13.6	12.2
<b>10</b>	--	76.0	--	38.0	18.0	16.0
<b>15</b>	--	--	--	55.0	27.0	24.0
<b>20</b>	--	--	--	72.0	34.0	31.0
<b>25</b>	--	--	--	89.0	43.0	38.0
<b>30</b>	--	--	--	106.0	51.0	46.0
<b>40</b>	--	--	--	140.0	67.0	61.0
<b>50</b>	--	--	--	173.0	83.0	75.0
<b>60</b>	--	--	--	206.0	99.0	90.0
<b>75</b>	--	--	--	255.0	123.0	111.0
<b>100</b>	--	--	--	341.0	164.0	148.0
<b>125</b>	--	--	--	425.0	205.0	185.0
<b>150</b>	--	--	--	506.0	246.0	222.0
<b>200</b>	--	--	--	675.0	330.0	294.0

### ELECTRICAL FORMULAS FOR CALCULATING AMPERES, HORSEPOWER, KILOWATTS AND KVA

Use to find:	Direct Current	Alternating Current	
		Single Phase	Three Phase
Amperes when HP is known	$\frac{\text{HP} \times 746}{\text{E} \times \% \text{EFF}}$	$\frac{\text{HP} \times 746}{\text{E} \times \% \text{EFF} \times \text{PF}}$	$\frac{\text{HP} \times 746}{\text{E} \times \% \text{EFF} \times \text{PF} \times \sqrt{3}}$
Amperes when kW is known	$\frac{\text{kW} \times 1000}{\text{E}}$	$\frac{\text{kW} \times 1000}{\text{E} \times \text{PF}}$	$\frac{\text{kW} \times 1000}{\text{E} \times \text{PF} \times \sqrt{3}}$
Amperes when kVA is known		$\frac{\text{kVA} \times 1000}{\text{E}}$	$\frac{\text{kVA} \times 1000}{\text{E} \times \sqrt{3}}$
Horsepower (HP)	$\frac{\text{E} \times \text{I} \times \% \text{EFF}}{746}$	$\frac{\text{E} \times \text{I} \times \% \text{EFF} \times \text{PF}}{746}$	$\frac{\text{E} \times \text{I} \times \% \text{EFF} \times \text{PF} \times \sqrt{3}}{746}$
Kilowatts (kW)	$\text{E} \times \text{I}$	$\text{E} \times \text{I} \times \text{PF}$	$\text{E} \times \text{I} \times \text{PF} \times \sqrt{3}$
Kilovolt-Amperes (kVA)		$\text{E} \times \text{I}$	$\text{E} \times \text{I} \times \sqrt{3}$

E = Voltage; %EFF = Percent Efficiency; PF = Power Factor of Motor; I = Amps

### OHM'S LAW

#### A. When Volts and OHMS are known:

Amperes = Volts / OHMS, or  $I = E / R$

*Example: Find the current of a 120 volt circuit with a resistance of 60 OHMS.*

$$I = E / R = 120 / 60 = 2 \text{ Amperes}$$

#### B. When Watts and Volts are known:

Amperes = Watts / Volts, or  $I = P / E$

*Example: A 120 Volt Circuit has a 1440 Watt Load. Determine the current.*

$$I = P / E = 1440 / 120 = 12 \text{ Amperes}$$

#### C. When OHMS and Watts are known:

Amperes =  $\sqrt{\text{Watts} / \text{OHMS}}$ , or  $I = \sqrt{P / R}$

*Example: A circuit consumes 625 watts through a 12.75 OHM resistor. Determine the current.*

$$I = \sqrt{P / R} = \sqrt{625 / 12.75} = \sqrt{49} = 7 \text{ Amperes}$$

#### Notes:

A. One electrical horsepower (HP) = 746 watts. Electric motors are rated in horsepower in the US (kW is used by many other countries).

B. One kilowatt (kW) = 1000 watts. Generators are rated in kilowatts.



FLA Three Phase Motors · FLA Transformers · Enclosure Heat Dissipation

APPROXIMATE FULL LOAD CURRENT IN AMPERES, THREE-PHASE MOTORS

Horsepower (HP)	Volts	Motor R.P.M.			
		@3800	@1800	@1200	@900
1/2	230	-	1.72	2.15	2.38
	460	-	0.86	1.08	1.19
3/4	230	-	2.46	2.93	3.26
	460	-	1.23	1.46	1.63
1	230	2.80	3.56	3.76	4.30
	460	1.40	1.78	1.88	2.15
1-1/2	230	4.36	4.86	5.28	5.60
	460	2.18	2.43	2.64	2.80
2	230	5.60	6.40	6.84	7.90
	460	2.80	3.20	3.42	3.95
3	230	8.34	9.40	10.20	11.40
	460	4.17	4.70	5.12	5.70
5	230	13.50	14.40	15.80	15.90
	460	6.76	7.21	7.91	7.92
7-1/2	230	19.50	21.50	21.80	23.00
	460	9.79	10.70	10.90	11.50
10	230	25.40	26.80	28.00	30.50
	460	12.70	13.40	24.00	15.20
15	230	36.40	39.20	41.40	44.50
	460	18.20	19.60	20.70	22.20
20	230	50.40	51.20	52.80	54.90
	460	25.20	25.60	26.40	27.40
25	230	60.80	64.80	65.60	67.30
	460	30.40	32.40	32.80	33.70
30	230	73.70	75.60	78.80	81.80
	460	36.80	37.80	39.40	40.90
40	230	96.40	101.00	102.00	105.00
	460	48.20	50.50	50.60	52.50
50	230	120.00	124.00	126.00	130.00
	460	60.00	62.00	63.00	65.00
60	230	143.00	149.00	150.00	154.00
	460	71.50	74.50	75.00	77.00
75	230	179.00	183.00	184.00	193.00
	460	89.60	91.50	92.00	96.50
100	230	231.00	236.00	239.00	252.00
	460	115.00	118.00	120.00	126.00
125	230	292.00	293.00	298.00	305.00
	460	146.00	147.00	149.00	153.00
150	230	343.00	348.00	350.00	365.00
	460	171.00	174.00	175.00	183.00
200	230	458.00	452.00	460.00	482.00
	460	229.00	226.00	230.00	241.00

FULL LOAD CURRENT AND OTHER DATA, THREE-PHASE, ALTERNATING-CURRENT MOTORS

Motor HP	Volts	Motor Amps	Size Breaker	NEMA Size Starter	Heater Amps	Size Wire AWG	Size Conduit
1	230	4.2	15	00	4.830	12	3/4"
	460	2.1	15	00	2.415	12	3/4"
1-1/2	230	6.0	15	00	6.900	12	3/4"
	460	3.0	15	00	3.450	12	3/4"
2	230	6.8	15	0	7.820	12	3/4"
	460	3.4	15	00	3.910	12	3/4"
3	230	9.6	15	0	11.040	12	3/4"
	460	4.8	15	0	5.520	12	3/4"
5	230	15.2	15	1	17.480	12	3/4"
	460	7.6	15	0	8.740	12	3/4"
7-1/2	230	22.0	40	1	25.300	10	3/4"
	460	11.0	30	1	12.650	12	3/4"
10	230	28.0	50	2	32.200	10	3/4"
	460	14.0	30	1	16.100	12	3/4"
15	230	42.0	70	2	48.300	6	1"
	460	21.0	40	2	24.150	10	3/4"
20	230	54.0	100	3	62.100	6	1"
	460	27.0	50	2	31.050	10	3/4"
25	230	68.0	100	3	78.200	4	1-1/2"
	460	34.0	50	2	39.100	8	1"

- Overcurrent device may have to be increased due to starting current and load conditions. See NEC Table 430-52. Wire based on 75°C terminations and insulation.
- Overload heater must be based on motor nameplate and sized per NEC 430-32.
- Conduit size based on rigid metal conduit with some spare capacity. For minimum size & other conduit types, see NEC Appendix C.

FULL LOAD CURRENT IN AMPERES, SINGLE-PHASE, TRANSFORMER

$$F.L.A. = \frac{kVA \times 1000}{Volts}$$

FULL LOAD CURRENT IN AMPERES, THREE-PHASE, TRANSFORMER

kVA	208V	240V	480V	kVA	208V	240V	480V
3	8.3	7.2	3.6	45	124	108	54
4	12.5	10.8	5.4	75	208	180	90
6	16.6	14.4	7.2	112	312	270	135
9	25.0	21.6	10.8	150	416	360	180
15	41.0	36.0	18.0	225	624	541	270
22	62.0	54.0	27.0	300	832	721	360
30	83.0	72.0	36.0	500	1389	1202	601

References

HEAT DISSIPATION IN ELECTRICAL ENCLOSURES

Selection Procedure:

- Determine input power in watts per square feet by dividing the heat dissipated in the enclosure (in watts) by the enclosure surface area (in square feet).
- Locate on the graph the appropriate input power on the horizontal axis and draw a line vertically until it intersects the temperature rise curve.
- Read horizontally to determine the enclosure temperature rise.

Example: What is the temperature rise that can be expected from a 48" x 36" x 16" enclosure with 300 watts of heat dissipated within it?

Solution: Surface Area = 2[(48x36) + (48x16) + (36x16)] divided by 144 sq.ft.

Input Power = 300 / 42 = 7.1 Watts/SqFt.

From Curve: Temp. Rise = 30°F (16.7°C)

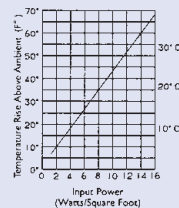



## Relay Cross Reference Guide · Ambient Temperature Derating Curve for Fuses

### RELAY CROSS REFERENCE GUIDE

Eaton	Rockwell Automation (Allen-Bradley)	Cyberdyn	Magnecraft (Struthers Dunn)	Omron	Tyco (Potter & Brumfield)	Square D	Tyco (Schrack)	Idec
D3PR2, D5PR2, D5PR3	700-HA32, 700-HAB2, 700-HAX2	N/A	750XBX, A314XBX, W250ACPX	MK2P	KRP(A)-11	8501KP12	MT2	RR2P
D3PR3	700-HA33, 700-HAB3, 700-HAX3	N/A	750XCX, A314XCX, W250CPX	MK3P	KRP(A)-14	8501KP13	MT3	RR3PA
D2PR4	700-HC14, 700-HC24	HJQ-22F	782XDX1, 782XDX2, W78(A)CSX	N/A	KHAU-17	8501RS(D)14, 8501RS(D)4	PT4	RU4S
D7PR2	700-HF32	N/A	782XBX, W78(A)R	N/A	K10	8501RS(D)42	N/A	RH2B
D7PR3	700-HF33	N/A	783XCX, 78XCX	N/A	N/A	8501RS(D)43	N/A	RH3B
D7PR4	700-HF34	N/A	784XDX, 78XDX	N/A	N/A	8501RS(D)44	N/A	RH4B
D2PR2	N/A	N/A	782XBX1, 782XBX2	N/A	KHUA-11	N/A	PT2	RU2S
D2PR5	N/A	N/A	N/A	N/A	N/A	N/A	N/A	RY2LS
D3PR5	N/A	N/A	N/A	MRL	N/A	N/A	N/A	RR2KP

### AMBIENT TEMPERATURE DERATING CURVE FOR FUSES

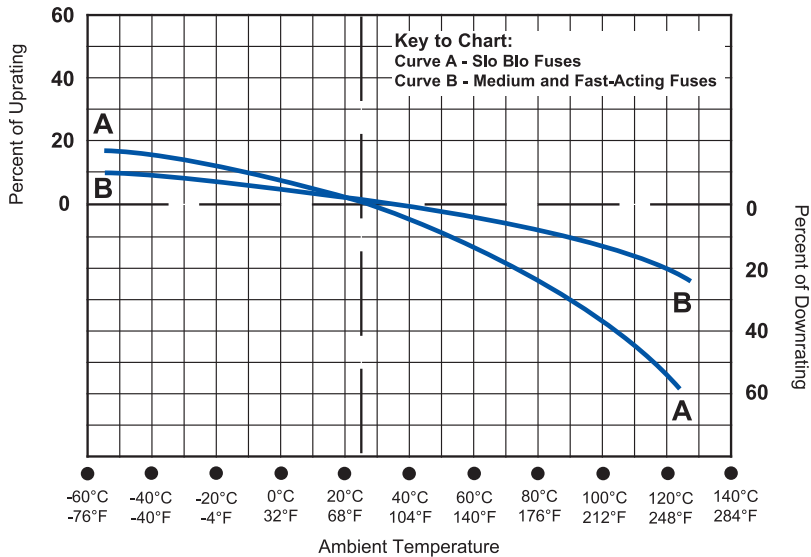

The current capacity of fuses is 110% of rating when installed in a standard UL test circuit and tested in open air at 25°C ambient. This allows for derating to 100% of rating in an enclosure at 40°C ambient. At higher ambient temperatures, continuous current-carrying capacity will be decreased as shown in the chart above. This closely follows the derating tables for all electrical equipment, and reduces equipment burnout due to high ambient conditions.



Motor Protection Tables – Fuse Selection based on Motor FLA

Using AC Motor Protection Tables to Select Fuse Ratings

Fuse ratings selected in accordance with the following recommendations also meet NEC requirements for Motor Branch Circuit and Short Circuit Protection.

Selecting Fuses for Motor Running Protection Based on Motor Actual Full Load Currents

Better protection is achieved when fuse ratings are based on motor actual FLA as obtained from motor nameplates. Locate motor nameplate FLA in the column appropriate for the type motor and type of protection required. Read to the left and obtain the recommended fuse ampere rating.

DUAL ELEMENT FUSES (FUSETRON)

Fuse Ampere Rating	Motor Full Load Amps (FLA)			
	Without Overload Relays		With Overload Relays	
	S.F. ≥ 1.15 or with Rise ≤ 40°C	S.F. < 1.15 or with Rise > 40°C	S.F. ≥ 1.15 or with Rise ≤ 40°C	S.F. < 1.15 or with Rise > 40°C
1/10	0.08 – 0.09	0.09 – 0.10	0.00 – 0.08	0.00 – 0.09
1/8	0.10 – 0.11	0.11 – 0.125	0.09 – 0.10	0.10 – 0.11
15/100	0.12 – 0.15	0.14 – 0.15	0.11 – 0.12	0.12 – 0.13
2/10	0.16 – 0.19	0.18 – 0.20	0.13 – 0.16	0.14 – 0.17
1/4	0.20 – 0.23	0.22 – 0.25	0.17 – 0.20	0.18 – 0.22
3/10	0.24 – 0.30	0.27 – 0.30	0.21 – 0.24	0.23 – 0.26
4/10	0.32 – 0.39	0.35 – 0.40	0.25 – 0.32	0.27 – 0.35
1/2	0.40 – 0.47	0.44 – 0.50	0.33 – 0.40	0.36 – 0.43
6/10	0.48 – 0.60	0.53 – 0.60	0.41 – 0.48	0.44 – 0.52
8/10	0.64 – 0.79	0.70 – 0.80	0.49 – 0.64	0.53 – 0.70
1	0.80 – 0.89	0.87 – 0.97	0.65 – 0.80	0.71 – 0.87
1-1/8	0.90 – 0.99	0.98 – 1.08	0.81 – 0.90	0.88 – 0.98
1-1/4	1.00 – 1.11	1.09 – 1.21	0.91 – 1.00	0.99 – 1.09
1-4/10	1.12 – 1.19	1.22 – 1.30	1.01 – 1.12	1.10 – 1.22
1-1/2	1.20 – 1.27	1.31 – 1.39	1.13 – 1.20	1.23 – 1.30
1-6/10	1.28 – 1.43	1.40 – 1.56	1.21 – 1.28	1.31 – 1.39
1-8/10	1.44 – 1.59	1.57 – 1.73	1.29 – 1.44	1.40 – 1.57
2	1.60 – 1.79	1.74 – 1.95	1.45 – 1.60	1.58 – 1.74
2-1/4	1.80 – 1.99	1.96 – 2.17	1.61 – 1.80	1.75 – 1.96
2-1/2	2.00 – 2.23	2.18 – 2.43	1.81 – 2.00	1.97 – 2.17
2-8/10	2.24 – 2.39	2.44 – 2.60	2.01 – 2.24	2.18 – 2.43
3	2.40 – 2.55	2.61 – 2.78	2.25 – 2.40	2.44 – 2.60
3-2/10	2.56 – 2.79	2.79 – 3.04	2.41 – 2.56	2.61 – 2.78
3-1/2	2.80 – 3.19	3.05 – 3.47	2.57 – 2.80	2.79 – 3.04
4	3.20 – 3.59	3.48 – 3.91	2.81 – 3.20	3.05 – 3.48
4-1/2	3.60 – 3.99	3.92 – 4.34	3.21 – 3.60	3.49 – 3.91
5	4.00 – 4.47	4.35 – 4.86	3.61 – 4.00	3.92 – 4.35
5-6/10	4.48 – 4.79	4.87 – 5.21	4.01 – 4.48	4.36 – 4.87
6	4.80 – 4.99	5.22 – 5.43	4.49 – 4.80	4.88 – 5.22
6-1/4	5.00 – 5.59	5.44 – 6.08	4.81 – 5.00	5.23 – 5.43
7	5.60 – 5.99	6.09 – 6.52	5.01 – 5.60	5.44 – 6.09
7-1/2	6.00 – 6.39	6.53 – 6.95	5.61 – 6.00	6.10 – 6.52
8	6.40 – 7.19	6.96 – 7.82	6.01 – 6.40	6.53 – 6.96
9	7.20 – 7.99	7.83 – 8.69	6.41 – 7.20	6.97 – 7.83
10	8.00 – 9.59	8.70 – 10.00	7.21 – 8.00	7.84 – 8.70

Fuse Ampere Rating	Motor Full Load Amps (FLA)			
	Without Overload Relays		With Overload Relays	
	S.F. ≥ 1.15 or with Rise ≤ 40°C	S.F. < 1.15 or with Rise > 40°C	S.F. ≥ 1.15 or with Rise ≤ 40°C	S.F. < 1.15 or with Rise > 40°C
12	9.60 – 11.99	10.44 – 12.00	8.01 – 9.60	8.71 – 10.43
15	12.00 – 13.99	13.05 – 15.00	9.61 – 12.00	10.44 – 13.04
17-1/2	14.00 – 15.99	15.22 – 17.39	12.01 – 14.00	13.05 – 15.21
20	16.00 – 19.99	17.40 – 20.00	14.01 – 16.00	15.22 – 17.39
25	20.00 – 23.99	21.74 – 25.00	16.01 – 20.00	17.40 – 21.74
30	24.00 – 27.99	26.09 – 30.00	20.01 – 24.00	21.75 – 26.09
35	28.00 – 31.99	30.44 – 34.78	24.01 – 28.00	26.10 – 30.43
40	32.00 – 35.99	34.79 – 39.12	28.01 – 32.00	30.44 – 37.78
45	36.00 – 39.99	39.13 – 43.47	32.01 – 36.00	37.79 – 39.13
50	40.00 – 47.99	43.48 – 50.00	36.01 – 40.00	39.14 – 43.48
60	48.00 – 55.99	52.17 – 60.00	40.01 – 48.00	43.49 – 52.17
70	56.00 – 59.99	60.87 – 65.21	48.01 – 56.00	52.18 – 60.87
75	60.00 – 63.99	65.22 – 69.56	56.01 – 60.00	60.88 – 65.22
80	64.00 – 71.99	69.57 – 78.25	60.01 – 64.00	65.23 – 69.57
90	72.00 – 79.99	78.26 – 86.95	64.01 – 72.00	69.58 – 78.26
100	80.00 – 87.99	86.96 – 95.64	72.01 – 80.00	78.27 – 86.96
110	88.00 – 99.99	95.65 – 108.69	80.01 – 88.00	86.97 – 95.65
125	100.00 – 119.99	108.70 – 125.00	88.01 – 100.00	95.66 – 108.70
150	120.00 – 139.99	131.30 – 150.00	100.01 – 120.00	108.71 – 130.43
175	140.00 – 159.99	152.17 – 173.90	120.01 – 140.00	130.44 – 152.17
200	160.00 – 179.99	173.91 – 195.64	140.01 – 160.00	152.18 – 173.91
225	180.00 – 199.99	195.65 – 217.38	160.01 – 180.00	173.92 – 195.62
250	200.00 – 239.99	217.39 – 250.00	180.01 – 200.00	195.63 – 217.39
300	240.00 – 279.99	260.87 – 300.00	200.01 – 240.00	217.40 – 260.87
350	280.00 – 319.99	304.35 – 347.82	240.01 – 280.00	260.88 – 304.35
400	320.00 – 359.99	347.83 – 391.29	280.01 – 320.00	304.36 – 347.83
450	360.00 – 399.99	391.30 – 434.77	320.01 – 360.00	347.84 – 391.30
500	400.00 – 479.99	434.78 – 500.00	360.01 – 400.00	391.31 – 434.78
600	480.00 – 600.00	521.74 – 600.00	400.01 – 480.00	434.79 – 521.74

References





## Motor Protection Tables – Fuse Selection based on Motor HP

Motor HP	Full Load Amps	Horsepower (HP)				Switch or Fuse Clip Rating
		Without Overload Relays		With Overload Relays		
		S.F. ≥ 1.15 or with Rise ≤ 40°C	S.F. < 1.15 or with Rise > 40°C	S.F. ≥ 1.15 or with Rise ≤ 40°C	S.F. < 1.15 or with Rise > 40°C	
<b>120 VOLT, 1-PHASE MOTORS – 120V CIRCUIT</b>						
1/6	4.4	5	5	5-6/10	5-6/10	30
1/4	5.8	7	6-1/4	7-1/2	7	30
1/3	7.2	9	8	9	9	30
1/2	9.8	12	10	15	12	30
3/4	13.8	15	15	17-1/2	17-1/2	30
1	16.0	20	17-1/2	20	20	30
1-1/2	20.0	25	20	25	25	30
2	24.0	30	25	30	30	30
<b>230 VOLT, 1-PHASE MOTORS – 240V CIRCUIT</b>						
1/6	2.2	2-1/2	2-1/2	2-8/10	2-8/10	30
1/4	2.9	3-1/2	3-2/10	4	3-1/2	30
1/3	3.6	4-1/2	4	4-1/2	4-1/2	30
1/2	4.9	5-6/10	5-6/10	6-1/4	6	30
3/4	6.9	8	7-1/2	9	8	30
1	8.0	10	9	10	10	30
1-1/2	10.0	12	10	15	12	30
2	12.0	15	12	15	15	30
3	17.0	20	17-1/2	25	20	30
5	28.0	35	30*	35	35	60
7-1/2	40.0	50	45	50	50	60
10	50.0	60	50	70	60	60
<b>200 VOLT, 3-PHASE MOTORS – 208V CIRCUIT</b>						
1/2	2.5	2-6/10	2-1/2	3	2-8/10	30
3/4	3.7	4	3-1/2	4-1/2	4	30
1	4.8	5	4-1/2	5-6/10	5	30
1-1/2	6.9	7	6-1/4	7-1/2	7	30
2	7.8	9	8	10	9	30
3	11.0	12	12	15	15	30
5	17.5	20*	20	25	25	30
7-1/2	25.3	30*	25*	35	30*	60
10	32.2	40	35	45	40	60
15	48.3	60	50	70*	60	60
20	62.1	75	70	80	75	100
25	78.2	90	80	100	90	100
30	92.0	110	100*	125	110	200
40	120.0	150	125	150	150	200
50	150.0	175*	150	200	175	200
60	177.0	200*	200*	225	225	400
75	221.0	250	250	300	300	400
100	285.0	350*	300	400	350	400
125	359.0	400*	400*	450	450	600
150	415.0	500	450	600	500	600
<b>230 VOLT, 3-PHASE MOTORS – 240V CIRCUIT</b>						
1/2	2.2	2-1/2	2-1/4	2-1/2	2-1/2	30
3/4	3.2	3-1/2	3-2/10	3-1/2	3-1/2	30
1	4.2	4-1/2	4	4-1/2	4-1/2	30
1-1/2	6.0	6-1/4	5-6/10	7	6	30
2	6.8	8	7-1/2	9	8	30
3	9.6	12	10	12	12	30
5	15.2	17-1/2	17-1/2	20	17-1/2	30
7-1/2	22.0	25	25	30	30	30
10	28.0	35	30*	35	35	60
15	42.0	50*	45	60	50	60
20	54.0	60*	60*	70	70	100
25	68.0	80	75	90	80	100
30	80.0	100	90	100	100	100
40	104.0	125	110	150	125	200
50	130.0	150	150	175	150	200
60	154.0	175	175	200	200	200
75	192.0	225	200*	250	225	400
100	248.0	300	250	350	300	400
125	312.0	350	350	400	400	400
150	360.0	450	400*	450	450	600
200	480.0	600	500	600	600	600

Motor HP	Full Load Amps	Horsepower (HP)				Switch or Fuse Clip Rating
		Without Overload Relays		With Overload Relays		
		S.F. ≥ 1.15 or with Rise ≤ 40°C	S.F. < 1.15 or with Rise > 40°C	S.F. ≥ 1.15 or with Rise ≤ 40°C	S.F. < 1.15 or with Rise > 40°C	
<b>480 VOLT, 3-PHASE MOTORS – 480V CIRCUIT</b>						
1/2	1.1	1-1/4	1-1/8	1-1/4	1-1/4	30
3/4	1.6	1-6/10	1-6/10	1-8/10	1-8/10	30
1	2.1	2-1/4	2	2-1/4	2-1/4	30
1-1/2	3.0	3-2/10	2-6/10	3-1/2	3	30
2	3.4	4	3-1/2	4-1/2	4	30
3	4.8	5-6/10	5	6	5-6/10	30
5	7.6	9	8	10	9	30
7-1/2	11.0	12	12	15	15	30
10	14.0	17-1/2	15	17-1/2	17-1/2	30
15	21.0	25	20	30	25	30
20	27.0	30*	30*	35	35	60
25	34.0	40	35	45	40	60
30	40.0	50	45	50	50	60
40	52.0	60*	60*	70	60*	100
50	65.0	80	70	90	75	100
60	77.0	90	80	100	90	100
75	96.0	110	110	125	125	200
100	124.0	150	125	175	150	200
125	156.0	175	175	200	200	200
150	180.0	225	200*	225	225	400
200	240.0	300	250	300	300	400
<b>575 VOLT, 3-PHASE MOTORS – 600V CIRCUIT</b>						
1/2	0.9	1	8/10	1	1	30
3/4	1.3	1-1/4	1-1/4	1-4/10	1-4/10	30
1	1.7	1-8/10	1-6/10	1-8/10	1-8/10	30
1-1/2	2.4	2-1/2	2-1/4	2-8/10	2-1/2	30
2	2.7	3-2/10	2-8/10	3-1/2	3-2/10	30
3	3.9	4-1/2	4	5	4-1/2	30
5	6.1	7-1/2	7	8	7-1/2	30
7-1/2	9.0	10	10	12	12	30
10	11.0	12	12	15	15	30
15	17.0	20	17-1/2	25	20	30
20	22.0	25	25	30	30	30
25	27.0	30*	30*	35	35	60
30	32.0	40	35	40	40	60
40	41.0	50	45	60	50	60
50	52.0	60	60	70**	60	60
60	62.0	75	70	80	75	100
75	77.0	90	80	100	90	100
100	99.0	110	110	125	125	200
125	125.0	150	125	175	150	200
150	144.0	175	150	200	175	200
200	192.0	225	200*	250	225	400

\*Fuse reducers required  
 \*\*100 Amp switch required  
 S.F. = Motor Service Factor

### SELECTING FUSES FOR MOTOR RUNNING PROTECTION BASED ON MOTOR HORSEPOWER









































Motor horsepower and motor full load amperes (FLA) shown are taken from NEC Tables 430.248 and 430.250 covering standard speed AC motors with normal torque characteristics. Fuse ratings for motors with special characteristics may need to vary from given values.

If motor running protection will be provided by the fuses, select fuse ratings for corresponding motor type from the table's columns headed "Without Overload Relays."

If overload relays will provide principle motor running protection, select fuse ratings for corresponding motor type from the table's columns headed "With Overload Relays." Fuse ratings selected from these columns coordinate with most UL Class 10 and 20 overload relays which cover over 90% of motor applications.



NEMA Straight Blade Configurations

Voltage	Type	15 Amperes		20 Amperes		30 Amperes		50 Amperes		60 Amperes	
		Receptacle	Plug	Receptacle	Plug	Receptacle	Plug	Receptacle	Plug	Receptacle	Plug
<b>2 POLE, 3 WIRE, GROUNDED</b>											
125V	5	 5-15R	 5-15P	 5-20R	 5-20P	 5-30R	 5-30P				
	TT					 TT-30R	 TT-30P				
250V	6	 6-15R	 6-15P	 6-20R	 6-20P	 6-30R	 6-30P	 6-50R	 6-50P		
277V AC	7			 7-20R	 7-20P						
<b>3 POLE, 3 WIRE, UNGROUNDED</b>											
125 / 250V	10			 10-20R	 10-20P	 10-30R	 10-30P	 10-50R	 10-50P		
<b>3 POLE, 4 WIRE, GROUNDED</b>											
125 / 250V	14			 14-20R	 14-20P	 14-30R	 14-30P	 14-50R	 14-50P		
3Ø 250V	15					 15-30R	 15-30P	 15-50R	 15-50P	 15-60R	 15-60P
<b>4 POLE, 4 WIRE, UNGROUNDED</b>											
3ØY 120 / 208V	18			 18-20R	 18-20P					 18-60R	 18-60P



## NEMA Turnlok® Device Configurations

Voltage	Type	15 Amperes		20 Amperes		30 Amperes			
		Receptacle	Plug	Receptacle	Plug	Receptacle	Plug		
<b>2 POLE, 3 WIRE, GROUNDED</b>									
125V	L5	L5-15R L515-R L515-C L515-FO 	L5-15P L515-P L515-FI 	L5-20R L520-R L520-C L520-FO 	L5-20P L520-P L520-FI 	L5-30R L530-R L530-C L530-FO 	L5-30P L530-P L530-FI 		
250V	L6	L6-15R L615-R L615-C L615-FO 	L6-15P L615-P L615-FI 	L6-20R L620-R L620-C L620-FO 	L6-20P L620-P L620-FI 	L6-30R L630-R L630-C L630-FO 	L6-30P L630-P L630-FI 		
277V AC	L7	L7-15R L715-R L715-C L715-FO 	L7-15P L715-P L715-FI 	L7-20R L720-R L720-C L720-FO 	L7-20P L720-P L720-FI 	L7-30R L730-R L730-C L730-FO 	L7-30P L730-P L730-FI 		
480V AC	L8	<b>Receptacle Legend</b> R = Receptacle C = Corded Female FO = Flanged Outlet		<b>Plug Legend</b> P = Plug FI = Flanged Inlet		L8-20R L820-R L820-C L820-FO 	L8-20P L820-P L820-FI 	L8-30R L830-R L830-C L830-FO 	L8-30P L830-P L830-FI 
600V AC	L9			L9-20R L920-R L920-C L920-FO 	L9-20P L920-P L920-FI 	L9-30R L930-R L930-C L930-FO 	L9-30P L930-P L930-FI 		
<b>3 POLE, 3 WIRE, UNGROUNDED</b>									
125 / 250V	L10			L10-20R L1020-R L1020-C L1020-FO 	L10-20P L1020-P L1020-FI 	L10-30R L1030-R L1030-C L1030-FO 	L10-30P L1030-P L1030-FI 		
3Ø 250V	L11			L11-20R L1120-R L1120-C L1120-FO 	L11-20P L1120-P L1120-FI 	L11-30R L1130-R L1130-C L1130-FO 	L11-30P L1130-P L1130-FI 		
3Ø 480V	L12			L12-20R L1220-R L1220-C L1220-FO 	L12-20P L1220-P L1220-FI 	L12-30R L1230-R L1230-C L1230-FO 	L12-30P L1230-P L1230-FI 		
3Ø 600V	L13					L13-30R L1330-R L1330-C L1330-FO 	L13-30P L1330-P L1330-FI 		
<b>3 POLE, 4 WIRE, GROUNDED</b>									
125 / 250V	L14			L14-20R L1420-R L1420-C L1420-FO 	L14-20P L1420-P L1420-FI 	L14-30R L1430-R L1430-C L1430-FO 	L14-30P L1430-P L1430-FI 		
3Ø 250V	L15			L15-20R L1520-R L1520-C L1520-FO 	L15-20P L1520-P L1520-FI 	L15-30R L1530-R L1530-C L1530-FO 	L15-30P L1530-P L1530-FI 		
3Ø 480V	L16			L16-20R L1620-R L1620-C L1620-FO 	L16-20P L1620-P L1620-FI 	L16-30R L1630-R L1630-C L1630-FO 	L16-30P L1630-P L1630-FI 		
<b>4 POLE, 4 WIRE, UNGROUNDED</b>									
3ØY 120 / 208V	L18			L18-20R L1820-R L1820-C L1820-FO 	L18-20P L1820-P L1820-FI 	L18-30R L1830-R L1830-C L1830-FO 	L18-30P L1830-P L1830-FI 		
3ØY 277 / 480V	L19			L19-20R L1920-R L1920-C L1920-FO 	L19-20P L1920-P L1920-FI 	L19-30R L1930-R L1930-C L1930-FO 	L19-30P L1930-P L1930-FI 		
3ØY 347 / 600V	L20			L20-20R L2020-R L2020-C L2020-FO 	L20-20P L2020-P L2020-FI 	L20-30R L2030-R L2030-C L2030-FO 	L20-30P L2030-P L2030-FI 		
<b>4 POLE, 5 WIRE, GROUNDED</b>									
3ØY 120 / 208V	L21			L21-20R L2120-R L2120-C L2120-FO 	L21-20P L2120-P L2120-FI 	L21-30R L2130-R L2130-C L2130-FO 	L21-30P L2130-P L2130-FI 		
3ØY 277 / 480V	L22			L22-20R L2220-R L2220-C L2220-FO 	L22-20P L2220-P L2220-FI 	L22-30R L2230-R L2230-C L2230-FO 	L22-30P L2230-P L2230-FI 		
3ØY 347 / 600V	L23			L23-20R L2320-R L2320-C L2320-FO 	L23-20P L2320-P L2320-FI 	L23-30R L2330-R L2330-C L2330-FO 	L23-30P L2330-P L2330-FI 		

References

## BENDING CATEGORY CABLES

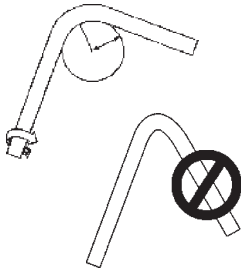

Maintain a maximum bend radius of 4 times the cable diameter (4-pair cables). Never exceed a 90 degree bend! Exceeding a 90 degree bend causes disruption in conductor and cable integrity.

## CABLE TIES

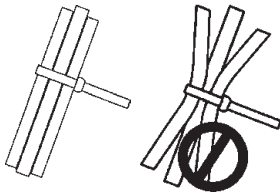

Apply cable ties loosely and at random intervals. Don't overtighten cable ties, as pinching or crushing will result in attenuation or impedance.

## TWISTING CABLES

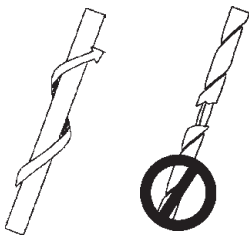

Try to minimize the amount of jacket twisting. If the cable is over-twisted, it can lead to torn jackets.

## STAPLE GUNS

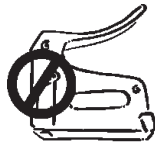

DO NOT use staple guns to position cables.

## CABLE TERMINATION

Make sure twisted pair cable maintains its pair twisting to within 1/2" or less of the point of termination on the connecting hardware.

Any untwisting of pairs greater than this will adversely affect the performance of the cable and reduce its ability to transmit at effective speed.

## CABLE RUNS

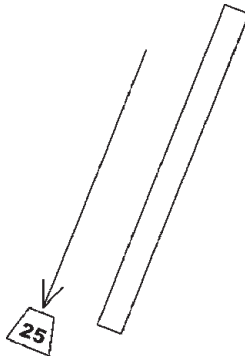

Try to plan out your installation so that you do not run cable further than 90 meters (295').

Never run data cables in the same conduit as electrical wiring.

Home run cable wherever possible to maximize data transmission.

Category 5 Patch cables... ANSI/TIA/EIA 568A allows for a maximum patch cable length of 6m (20') in the wiring closet and 3m (10') at the workstation outlet. If either of these lengths is exceeded, your horizontal cable run must be reduced by the excess amount.

When pulling cable, avoid kinking and tugging. Constant tension should be used when pulling cable into place. EIA/TIA-568A specifies a 25 pound maximum pulling tension for category cable installations.

## INSTALLATION TIPS

Many networks that run on UTP cable use only two of the four pair of wires. To prevent crosstalk, do not use the second unused pair for voice or other data applications.

When routing cables through walls and ceilings, always keep data cable as far as possible from sources of EMI (electromagnetic interference) and RFI (radio frequency interference), such as fluorescent lights, electric panels, light dimmers and electrical motors.

Avoid heat and moisture. High temperature and moist locations may cause attenuation problems.

Select only the highest grade category cables as overall performance is a key ingredient for system success.

Patch cables are intended to be flexed and moved. Stranded conductor patch cords are recommended due to their greater flexibility over solid conductors.

## BASIC TOPOLOGIES

**Star Topology** utilizes a central point of control. Each station or device in the telecommunications system communicates via point to point wiring to the central link. In most situations, address recognition and routing is performed at the central control point.

A star topology is considered the easiest to design and install since each station's cabling is run directly out from the central location to the appropriate work area. It is also adaptable to other topologies.

**Ring Topology** is structured with stations cabled together in a logical circle. Information travels in one direction passing through each station and only stopping at the addressed station. Only one station can transmit on the ring at any one time. Stations take turns gaining access to the ring via polling or by passing an access token from one to another.

**Bus Topology** has all the devices attached to a linear transmission media. When a station transmits, the signal travels in both directions. Signals travelling along the bus are made available to all stations. Each station checks the intended address of the signal and ignores all information not addressed to its location.

## Conduit Bending Instructions – EMT Bender

### ACCURATE STUBS

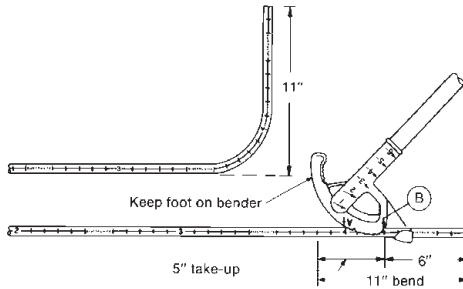

Subtract take-up from desired stub height. This gives distance at which to place B on bender from the end of the tube. To make an 11", 90° bend with 1/2" tube, allow 5" for take-up as shown on diagram. With 3/4" tube, allow 6". With 1" tube, allow 8".

### TRUE OFFSETS

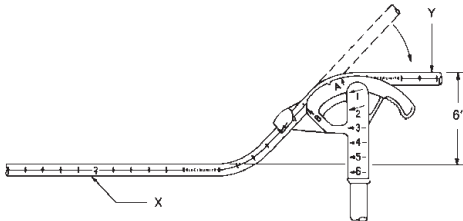

Line up arrow on either side of hook with guide-line and make 45° bend in tube. Reverse tube in bender and adjust so that X is lined up with inch-mark on bender corresponding to depth of offset desired. Line up guide-line with opposite arrow and make second 45° bend. A true offset, in the same plane, will result between X and Y.

### BACK-TO-BACK BENDS

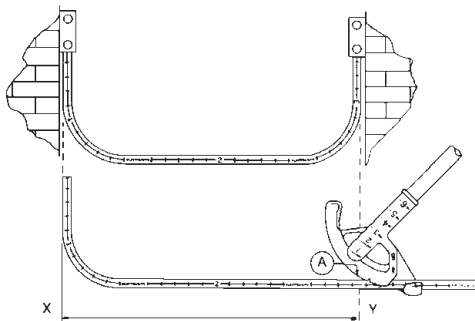

Make stub bend at X with guide-line centered on either arrow located on side of hook. Measure distances from X to Y on tube. Reverse bender and put A on bender at Y on tube. Line up guide-line with opposite arrow used when making first stub and make second bend.

### SADDLE BENDS

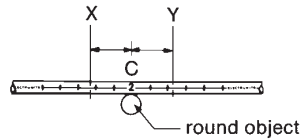

C = Center of finished Saddle Bend  
 X = Double of the diameter of round object from C  
 Y = Double of the diameter of round object from C

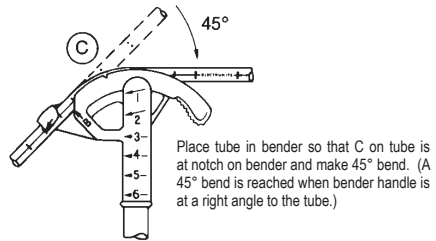

Place tube in bender so that C on tube is at notch on bender and make 45° bend. (A 45° bend is reached when bender handle is at a right angle to the tube.)

Reverse tube in bender and place B on bender at X on tube. Make return bend of 22½°.

Duplicate procedure placing B on bender at Y on tube and complete saddle by making another 22½° bend.

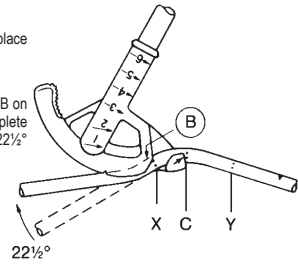

Finished bend neatly saddles round object.

Proper alignment of the guide line with arrows on bender hook will result in the saddle being in a straight line.

### TO STRAIGHTEN

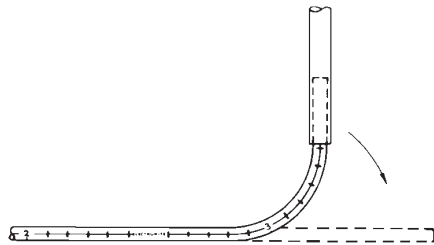

Place handle of bender over stub or piece of pipe that will fit inside and push down to the floor in one full sweep.



Lighting Guide

FLOOD LIGHTING CALCULATIONS

- Step 1:** Determine foot-candle level from outdoor foot-candle table below.
  - Step 2:** Determine square footage of area to be lighted (length x width).
  - Step 3:** Determine type of fixture to be used and proper mounting height.
  - Step 4:** Identify initial lumens of fixture type.
  - Step 5:** Determine dirt depreciation factor of fixture from Light Depreciation Chart.
  - Step 6:** Use formula with above data to calculate number of fixtures. Round fractions to nearest whole number.
- Formula:** Number of Fixtures = 3 x (Number of Foot-Candles Needed) x (Square Footage of Area) / (Initial Lumens of Fixture Lamp Type) x (Dirt Depreciation)
- Example:** Using 400 watt High Pressure Sodium (HPS) on 30 foot pole.  
 $3 \times 2 \times 40,000 / 50,000 \times 1.01 = 4.85$ . All fractions should be rounded off. Required number of fixtures = 5.
- Note:** This is not a precise lighting guide.

FOOT-CANDLE TABLE

Lighting Area	Recommended Foot-Candles
Storage Yards – Inactive	1
Railroad Yard Switch Points	2
Shipyards	5
General Building Construction	10
Corridors / Stairways / Restrooms	10 – 20
Storage Rooms	10 – 50
Storage Yards – Active	20
Loading Platforms	20
Conference Rooms	20 – 50
Gymnasiums	30 – 50
Merchandising	30 – 150
Cafeterias	50
Classrooms	50 – 75
General Offices	50 – 100
Manufacturing Assembly	50 – 500
Areas with Video Display Terminals (VDTs)	75
Drafting / Accounting	100 – 200
<b>AIRPORTS</b>	
Terminal Apron / Parking	0.5
Hangar Aprons	1
<b>BULLETIN BOARDS</b>	
Light Surfaces	20 – 50
Dark Surfaces	50 – 100
<b>PARKING AREAS / VEHICULAR TRAFFIC</b>	
Low Activity	1
Medium Activity	2
High Activity	2
<b>SPORTS</b>	
Playground	5
Basketball Court – Recreational	10
Baseball – Recreational	10 – 15
Tennis Court – Club	20
Basketball Court – High School	30

LIGHT DEPRECIATION CHART

Clean Environment	Medium Environment	Dirty Environment
0.96	1.01	1.06

MOUNTING HEIGHT GUIDE

Watts	High Pressure Sodium (HPS)	Metal Halide (MH)	Mercury Vapor	Tungsten / Halogen
70	10 – 15'	–	–	–
100	15 – 20'	–	–	–
150	20 – 25'	–	–	–
175	–	–	18 – 23'	–
200	20 – 25'	–	–	–
250	22 – 27'	20 – 25'	20 – 25'	–
400	30 – 35'	25 – 30'	20 – 25'	–
500	–	–	–	15 – 20'
1000	40 – 50'	40 – 45'	35 – 40'	20 – 25'
1500	–	–	–	25 – 30'

INDOOR LIGHTING CALCULATIONS  
ZONAL CAVITY METHOD

- Step 1. Determine cavity ratios** = (2.5 X height of cavity X cavity perimeter) / area of cavity base
  - Step 2. Determine effective cavity reflectances:** use chart below
  - Step 3. Select coefficient of utilization:** use manufacturer's tables with effective cavity reflectances from step 2 for specific fixture type
  - Step 4. Compute average illuminance level :** use formula below to determine appropriate number of fixtures
- Number of Fixtures** = (room area in square feet X desired foot candles) / (lumens per fixture X coefficient of utilization)
- Note:** This method is used for estimating purposes only and other factors may contribute to resulting illuminance level. Refer to the IESNA Lighting Handbook for further details.

% Ceiling or Floor Reflectance	90				50				10			
	90	70	50	30	70	50	30	10	50	30	10	
<b>% Wall Reflectance</b>	90	70	50	30	70	50	30	10	50	30	10	
<b>Cavity Ratio</b>												
0.2	89	88	86	85	49	48	47	30	10	10	09	
0.4	88	86	84	81	48	47	45	30	11	10	09	
0.6	87	84	80	77	47	45	43	30	11	10	08	
0.8	87	82	77	73	47	44	40	30	11	10	08	
1.0	86	80	75	69	46	43	38	30	12	10	08	
1.2	85	78	72	66	45	41	36	30	12	10	07	
1.4	85	77	69	62	45	40	35	30	12	10	07	
1.6	84	75	67	59	44	39	33	29	12	09	07	
1.8	83	73	64	56	43	38	31	29	13	09	06	
2.0	83	72	62	53	43	37	30	29	13	09	06	
2.2	82	70	59	50	42	36	29	29	13	09	06	
2.4	82	69	58	48	42	35	27	29	13	09	06	
2.6	81	67	56	46	41	34	26	29	13	09	06	
2.8	81	66	54	44	41	33	25	29	13	09	05	
3.0	80	64	52	42	40	32	24	29	13	09	05	
3.2	79	63	50	40	39	31	23	29	13	09	05	
3.4	79	62	48	38	39	30	22	29	13	09	05	
3.6	78	61	47	36	39	29	21	29	13	09	04	
3.8	78	60	45	35	38	29	21	28	14	09	04	
4.0	77	58	44	33	38	28	20	28	14	09	04	
4.2	77	57	43	32	37	28	20	28	14	09	04	
4.4	76	56	42	31	37	27	19	28	14	08	04	
4.6	76	55	40	30	36	26	18	28	14	08	04	
4.8	75	54	39	28	36	26	18	28	14	08	04	
5.0	75	53	38	28	35	25	17	28	14	08	04	

References



## NEMA Enclosure Type Classifications

NEMA Type	Description
<b>1</b>	Enclosures constructed for indoor use to provide a degree of protection to personnel against incidental contact with the enclosed equipment and to provide a degree of protection against falling dirt.
<b>2</b>	Same as NEMA Type 1 including protection against dripping and light splashing of liquids.
<b>3</b>	Enclosures constructed for either indoor or outdoor use to provide a degree of protection to personnel against incidental contact with the enclosed equipment; to provide a degree of protection against falling dirt, rain, sleet, snow, and windblown dust; and that will be undamaged by the external formation of ice on the enclosure.
<b>3R</b>	Same as NEMA Type 3 excluding protection against windblown dust.
<b>3S</b>	Enclosures constructed for either indoor or outdoor use to provide a degree of protection to personnel against incidental contact with the enclosed equipment; to provide a degree of protection against falling dirt, rain, sleet, snow, and windblown dust; and in which the external mechanism(s) remain operable when ice laden.
<b>4</b>	Enclosures constructed for either indoor or outdoor use to provide a degree of protection to personnel against incidental contact with the enclosed equipment; to provide a degree of protection against falling dirt, rain, sleet, snow, windblown dust, splashing water, and hose-directed water; and that will be undamaged by the external formation of ice on the enclosure.
<b>4X</b>	Same as NEMA Type 4 including protection against corrosion.
<b>5</b>	Enclosures constructed for indoor use to provide a degree of protection to personnel against incidental contact with the enclosed equipment; to provide a degree of protection against falling dirt; against settling airborne dust, lint, fibers, and flyings; and to provide a degree of protection against dripping and light splashing of liquids.
<b>6</b>	Enclosures constructed for either indoor or outdoor use to provide a degree of protection to personnel against incidental contact with the enclosed equipment; to provide a degree of protection against falling dirt; against hose-directed water and the entry of water during occasional temporary submersion at a limited depth; and that will be undamaged by the external formation of ice on the enclosure.
<b>6P</b>	Same as NEMA Type 6 including protection against the entry of water during prolonged submersion at a limited depth.
<b>7</b>	Enclosures are for indoor use in locations classified as Class I, Groups A, B, C, or D and shall be capable of withstanding the pressures resulting from an internal explosion of specified gases, and contain such an explosion sufficiently that an explosive gas-air mixture existing in the atmosphere surrounding the enclosure will not be ignited. Enclosed heat generating devices shall not cause external surfaces to reach temperatures capable of igniting explosive gas-air mixtures in the surrounding atmosphere. Enclosures shall meet explosion, hydro-static, and temperature design tests.
<b>9</b>	Enclosures are intended for indoor use in locations classified as Class II, Groups E, F, or G, and shall be capable of preventing the entrance of dust. Enclosed heat generating devices shall not cause external surfaces to reach temperatures capable of igniting or discoloring dust on the enclosure or igniting dust-air mixtures in the surrounding atmosphere. Enclosures shall meet dust penetration and temperature design tests, and aging of gaskets (if used).
<b>12</b>	Enclosures constructed (without knockouts) for indoor use to provide a degree of protection to personnel against incidental contact with the enclosed equipment; to provide a degree of protection against falling dirt; against circulating dust, lint, fibers, and flyings; and against dripping and light splashing of liquids.
<b>12K</b>	Same as NEMA Type 12 including enclosures constructed with knockouts.
<b>13</b>	Enclosures constructed for indoor use to provide a degree of protection to personnel against incidental contact with the enclosed equipment; to provide a degree of protection against falling dirt; against circulating dust, lint, fibers, and flyings; and against the spraying, splashing, and seepage of water, oil, and non-corrosive coolants.



Common Pilot Device Diagrams

START / STOP FOR NON-REVERSING STARTER

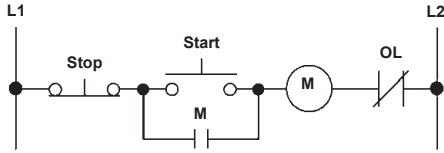

Device Type	Operator	Contact Block	Legend Plate
Start Button	10250T103	10250T53C	10250TM33
Stop Button	10250T102	10250T51C	10250TM34

START / STOP WITH MOTOR RUN LIGHT

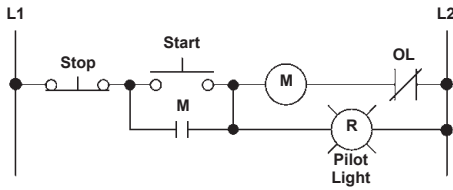

Device Type	Operator	Contact Block	Legend Plate
Start Button	10250T103	10250T53C	10250TM33
Stop Button	10250T102	10250T51C	10250TM34
Run Light	10250T181N	10250TC1N	10250TM31

HAND / OFF / AUTO CIRCUIT

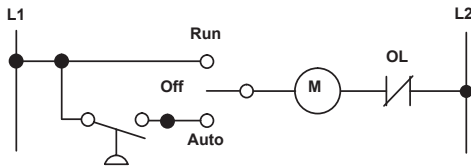

Device Type	Operator	Contact Block	Legend Plate
Selector Switch	10250T1323	10250T2C	10250TM51

FORWARD / STOP / REVERSE FOR REVERSING STARTER

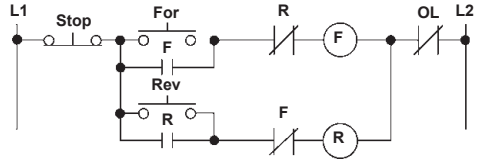

Device Type	Operator	Contact Block	Legend Plate
Forward Button	10250T103	10250T53C	10250TM15
Stop Button	10250T102	10250T51C	10250TM34
Reverse Button	10250T101	10250T53C	10250TM30

START / STOP WITH MOTOR OFF LIGHT

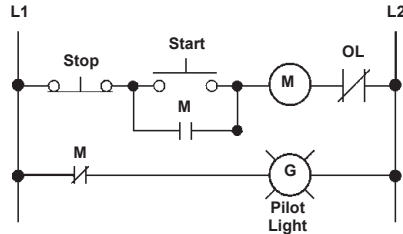

Device Type	Operator	Contact Block	Legend Plate
Start Button	10250T103	10250T53C	10250TM33
Stop Button	10250T102	10250T51C	10250TM34
Off Light	10250T181N	10250TC2N	10250TM24

START / STOP WITH JOG / RUN SELECTOR SWITCH

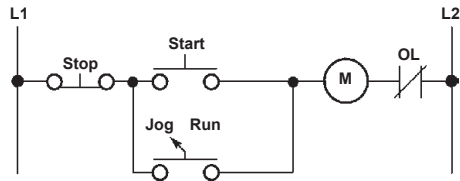

Device Type	Operator	Contact Block	Legend Plate
Start Button	10250T103	10250T53C	10250TM33
Stop Button	10250T102	10250T51C	10250TM34
Selector Switch	10250T1311	10250T53C	10250TM44

References







### Summary of Code Requirements for Lighting Control

Vive wireless solutions ensure you can meet new construction and retrofit (lighting alterations code requirements for ASHRAE 2010, ASHRAE 2013, IECC 2012, IECC 2015, and Title 24-2016).

For specific commercial building code lighting requirements in your state, please visit [www.lutron.com/energycodes](http://www.lutron.com/energycodes).

Control Method(s)	Code Requirements					Solution(s)	
	ASHRAE 90.1-2010	ASHRAE 90.1-2013	IECC 2012	IECC 2015	Title 24-2016	Vive	Vive with Wireless Hub
Local Switch	•	•	•	•	•	√	√
Occupancy Sensing	•	•	•	•	•	√	√
Bi-Level Control	•	•	•	•	•	√	√
Multi-Level Dimming					•	√	√
Automatic Daylighting	•	•		•	•	√	√
Demand Response					•		√
Energy Monitoring		•			•		√

Key: • New Construction • Lighting Alteration

Disclaimer: This table is a summary only; other exceptions or details may apply. Jurisdictions may have requirements that differ from these standards. For specific code requirements please visit: [www.lutron.com/energycodes](http://www.lutron.com/energycodes)



Warning! · Counterfeit Circuit Breakers · Warning!

## WARNING! WARNING! WARNING! COUNTERFEIT CIRCUIT BREAKERS

### WHY BUY NEW?

You should never compromise when selecting the electrical device whose fundamental purpose is protection. When you buy an Eaton circuit breaker from Elliott Electric Supply, you get a circuit breaker you can depend on, plus a whole lot more.

### RELIABILITY

Eaton assures the quality and reliability of each new circuit breaker before it leaves the manufacturing facility. Each unit is tested with state-of-the-art test equipment especially designed for each type of breaker. Eaton circuit breakers carry UL 489 and IEC 60947-2 ratings and meet or exceed many other international testing standards.

### SAFETY

Accidents happen each day. The risk of equipment damage or injured personnel may be reduced by using the correct circuit protective devices. In order to assure your safety, you need to know the differences between new, used and surplus and third-party repaired circuit breakers. When it comes to protecting your equipment and people, it is truly what you don't know that can hurt you.

### PEACE OF MIND

Why risk buying used, surplus or third-party repaired breakers? The cost of even one circuit failing to operate can be staggering and the results catastrophic, maybe even tragic. There is also the whole issue of liability. As the individual who decides whether to buy used or buy new, you bear great responsibility. Why risk your reputation, your livelihood, or your safety?

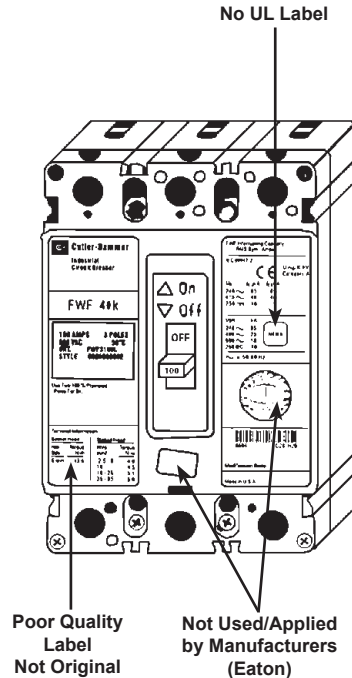

## HOW TO SPOT A COUNTERFEIT BREAKER

### Missing Date Code

- Removed to hide the age of the circuit breaker.

### Old Date Code

- Any product over two years old no longer has any factory warranty.

### Factory Seals Broken or Removed

- Product has been tampered with and has no warranty or guarantee that it meets performance specifications.

### Mislabeled Products to Change Size/Type

- Product has been tampered with, causing a possible misapplication and a safety hazard.

### Non-English Text

- Product that appears with labels in languages other than English.

### Missing UL Sticker

- Product is likely imported illegally and is NOT certified to meet U.S. electrical codes.

### Low-Quality Labeling and/or Misspelled Words

- Product is likely a counterfeit and made with substandard materials and workmanship.

### Old Westinghouse or Challenger Label



















- These products have not been produced since 1999 and 1997 respectively.

### Not in a Carton or in Older White Carton

- Product is used and/or outdated



# Power Defense Molded Case Circuit Breaker Replacement Guide

125 A	225 A	250 A	400 A	600 A	800 A	1200 A	2500 A
<b>POWER DEFENSE™—GLOBAL—UL®/CSA®/CE/CCC</b> Dimensions in inches (per three-pole breaker)							
<b>PDG1</b>	<b>PDG2</b>	<b>PDG3</b>		<b>PDG4</b>	<b>PDG5</b>	<b>PDG6</b>	
125 A Frame (15–125 A)	225 A Frame (15–225 A)	400 A & 600 A Frame (45–600 A)		800 A Frame (300–800 A)	800 A & 1200 A Frame (320–1200 A)	1600 A, 2000 A & 2500 A Frame (700–2500 A)	
 W: 3.00 H: 5.50 D: 3.00	 W: 4.13 H: 6.00 D: 3.50	 W: 5.50 H: 10.10 D: 4.30		 W: 8.25 H: 16.00 D: 4.38	 W: 8.30 H: 16.00 D: 5.50	 W: 15.50 H: 16.00 D: 9.80	
<b>SERIES G—GLOBAL—UL/CSA/CE/CCC</b> Dimensions in inches (per three-pole breaker)							
<b>EG</b>	<b>JG</b>		<b>LG</b>	<b>NG</b>		<b>RG</b>	
125 A Frame (15–125 A)	250 A Frame (20–250 A)		600 A Frame (100–600 A)	800 A & 1200 A Frame (320–1200 A)		1600 A, 2000 A & 2500 A Frame (800–2500 A)	
 W: 3.00 H: 5.50 D: 3.00	 W: 4.13 H: 7.00 D: 3.57		 W: 5.50 H: 10.10 D: 4.10	 W: 8.30 H: 16.00 D: 5.50		 W: 15.50 H: 16.00 D: 9.80	
<b>SERIES C—DOMESTIC—UL/CSA</b> Dimensions in inches (per three-pole breaker)							
<b>GD</b>	<b>FD</b>	<b>JD</b>	<b>KD</b>	<b>LD</b>	<b>MDL</b>	<b>ND (Aftermarket)</b>	<b>RD (Aftermarket)</b>
100 A Frame (15–100 A)	225 A Frame (15–225 A)	250 A Frame (70–250 A)	400 A Frame (55–400 A)	600 A Frame (70–600 A)	800 A Frame (300–800 A)	800 A & 1200 A Frame	1600 A, 2000 A & 2500 A Frame
 W: 3.00 H: 4.88 D: 2.63	 W: 4.13 H: 6.00 D: 3.38	 W: 4.13 H: 10.00 D: 4.06	 W: 5.50 H: 10.10 D: 4.10	 W: 8.25 H: 10.80 D: 4.06	 W: 8.25 H: 16.00 D: 4.06	 W: 8.30 H: 16.00 D: 5.50	 W: 15.50 H: 16.00 D: 9.80

Note: Available Continuous Current Ranges are Shown in Parentheses. These Options are Dependent on the Frame and Trip Unit Used with Each Breaker. Please Consult Eaton's Volume 4 Circuit Protection Catalog for More Information.



**Product selector and technical data**

Scan the QR code for additional assistance in selecting a breaker or to obtain data sheets and 2D or 3D drawings. You can also visit our website at [Eaton.com/PowerDefense](http://Eaton.com/PowerDefense).



**Store Information: Arizona, Arkansas**

**Arizona**

<b>NEW STORE!</b>	<b>DEER VALLEY</b> #153 PHONE: 480-681-0668 FAX: 480-681-0669	<b>24/7 CONTACTS</b>
	Steven Dawson ..... StevenDawson@elliottelectric.com ..... Branch Manager Host Store: <b>Phoenix, AZ #148</b>	M-F: 5am-4pm Sat: 8am-Noon 21415 North 15th Lane, #116 Phoenix, AZ 85027
<b>NEW STORE!</b>	<b>MESA</b> #152 PHONE: 623-900-2983 FAX: 623-900-2984	<b>24/7 CONTACTS</b>
	Nick Shattuck ..... NickShattuck@elliottelectric.com ..... Branch Manager Host Store: <b>Phoenix, AZ #148</b>	M-F: 5am-4pm Sat: 8am-Noon 2250 West Broadway Road, #102 Mesa, AZ 85202
<b>NEW STORE!</b>	<b>PHOENIX</b> #148 PHONE: 480-372-4901 FAX: 480-372-4902	<b>24/7 CONTACTS</b>
	Quentin Bell ..... QuentinBell@elliottelectric.com ..... Area Manager Michael Daake ..... MichaelDaake@elliottelectric.com ..... Area Operations Manager	M-F: 5am-4pm Sat: 8am-Noon 121 South 39th Avenue, #100 Phoenix, AZ 85009
<b>NEW STORE!</b>	<b>TUCSON</b> #159 PHONE: 520-526-1947 FAX: 520-526-1948	<b>24/7 CONTACTS</b>
	Conrad Marks ..... ConradMarks@elliottelectric.com ..... Operations Manager Host Store: <b>Phoenix, AZ #148</b>	M-F: 6am-4pm Sat: 8am-Noon 3130 S. Dodge Boulevard Tucson, AZ 85713

**Arkansas**

<b>NEW STORE!</b>	<b>BENTON</b> #131 PHONE: 501-303-4983 FAX: 501-508-4978	<b>24/7 CONTACTS</b>
	Matthew Thompson ..... MatthewThompson@elliottelectric.com ..... Branch Manager Host Store: <b>Little Rock, AR #091</b>	M-F: 7am-5:30pm Sat: 8am-Noon 2114 Military Road Benton, AR 72015
<b>NEW STORE!</b>	<b>BENTONVILLE</b> #112 PHONE: 479-250-1930 FAX: 479-250-1931	<b>24/7 CONTACTS</b>
	Tom Dawson ..... TomDawson@elliottelectric.com ..... Branch Manager Host Store: <b>Springdale, AR #106</b>	M-F: 7am-5pm Sat: 8am-Noon 908 Southeast 21st Street Bentonville, AR 72712
<b>NEW STORE!</b>	<b>CABOT</b> #094 PHONE: 501-605-1780 FAX: 501-605-1785	<b>24/7 CONTACTS</b>
	Lawrence Gabbard ..... LawrenceGabbard@elliottelectric.com ..... Branch Manager Host Store: <b>Little Rock, AR #091</b>	M-F: 7am-5pm Sat: Closed 132 Professional Drive Cabot, AR 72023
<b>NEW STORE!</b>	<b>CONWAY</b> #099 PHONE: 501-336-8444 FAX: 501-329-5636	<b>24/7 CONTACTS</b>
	Ian Buchanan ..... IanBuchanan@elliottelectric.com ..... Operations Manager Lawrence Gabbard ..... LawrenceGabbard@elliottelectric.com ..... Branch Manager Host Store: <b>Little Rock, AR #091</b>	M-F: 6:30am-5pm Sat: Closed 520 Equity Avenue Conway, AR 72032
<b>NEW STORE!</b>	<b>EL DORADO</b> #138 PHONE: 870-639-6289 FAX: 870-864-8850	<b>24/7 CONTACTS</b>
	Wayne Jackson ..... WayneJackson@elliottelectric.com ..... Branch Manager Host Store: <b>West Monroe, LA #055</b>	M-F: 7am-5:30pm Sat: 8am-Noon 805 South Timberlane Drive El Dorado, AR 71730
<b>NEW STORE!</b>	<b>FAYETTEVILLE</b> #125 PHONE: 479-443-4948 FAX: 479-443-6465	<b>24/7 CONTACTS</b>
	Tom Dawson ..... TomDawson@elliottelectric.com ..... Branch Manager Host Store: <b>Springdale, AR #106</b>	M-F: 7am-5:30pm Sat: 8am-Noon 2642 South School Street Fayetteville, AR 72701
<b>NEW STORE!</b>	<b>FORT SMITH</b> #105 PHONE: 479-648-1902 FAX: 479-648-1960	<b>24/7 CONTACTS</b>
	Eric Lind ..... EricLind@elliottelectric.com ..... Branch Manager Host Store: <b>Springdale, AR #106</b>	M-F: 7am-5:30pm Sat: 8am-Noon 5500 Wheeler Avenue Fort Smith, AR 72901
<b>NEW STORE!</b>	<b>HOPE</b> #037 PHONE: 870-777-4225 FAX: 870-777-4343	<b>24/7 CONTACTS</b>
	Blain Halliday ..... BlainHalliday@elliottelectric.com ..... Branch Manager Host Store: <b>Texarkana, TX #030</b>	M-F: 7am-5:30pm Sat: 8am-Noon 1615 North Hazel Street Hope, AR 71801
<b>NEW STORE!</b>	<b>HOT SPRINGS</b> #114 PHONE: 501-762-8210 FAX: 501-762-8211	<b>24/7 CONTACTS</b>
	Matthew Thompson ..... MatthewThompson@elliottelectric.com ..... Branch Manager Host Store: <b>Little Rock, AR #091</b>	M-F: 7am-5:30pm Sat: 8am-Noon 411 Autumn Street Hot Springs, AR 71901
<b>NEW STORE!</b>	<b>LITTLE ROCK</b> #091 PHONE: 501-565-1785 FAX: 501-565-0827	<b>24/7 CONTACTS</b>
	James Felton ..... JamesFelton@elliottelectric.com ..... Operations Manager Donald White ..... DonaldWhite@elliottelectric.com ..... Area Manager	M-F: 7am-5:30pm Sat: 8am-Noon 5505 West 65th Street Little Rock, AR 72209
<b>NEW STORE!</b>	<b>MAGNOLIA</b> #139 PHONE: 870-626-4277 FAX: 870-234-7640	<b>24/7 CONTACTS</b>
	Michael Kordsmeier ..... MichaelKordsmeier@elliottelectric.com ..... Branch Manager Host Store: <b>Texarkana, TX #030</b>	M-F: 7am-5:30pm Sat: 8am-Noon 102 Harvey Couch Boulevard Magnolia, AR 71753

References



# ELLIOTT ELECTRIC SUPPLY

L27

## Store Information: Arkansas, Georgia, Kansas

### Arkansas (cont.)

<b>NORTH LITTLE ROCK</b> #086 PHONE: 501-945-9398 FAX: 501-508-2426	<b>24/7 CONTACTS</b>
Rick Debord ..... RickDebord@elliotelectric.com ..... Branch Manager Host Store: <b>Little Rock, AR #091</b>	M-F: 7am-5:30pm Sat: 8am-Noon 1501 North Cypress Street North Little Rock, AR 72114
Rick .....501-831-3852	
<b>PINE BLUFF</b> #149 PHONE: 870-671-4805 FAX: 870-671-4806	<b>24/7 CONTACTS</b>
Patrick Fisher ..... PatrickFisher@elliotelectric.com ..... Branch Manager Host Store: <b>Little Rock, AR #091</b>	M-F: 7am-5:30pm Sat: 8am-Noon 6520 West Barraque Street White Hall, AR 71602
Patrick .....501-231-5373	
<b>ROGERS</b> #124 PHONE: 479-636-4190 FAX: 479-636-5604	<b>24/7 CONTACTS</b>
Tom Dawson ..... TomDawson@elliotelectric.com ..... Branch Manager Host Store: <b>Springdale, AR #106</b>	M-F: 7am-5pm Sat: Closed 2214 South 8th Street Rogers, AR 72756
Tom .....479-616-6041	
<b>RUSSELLVILLE</b> #104 PHONE: 479-967-2303 FAX: 479-967-2306	<b>24/7 CONTACTS</b>
Terry Hansell ..... TerryHansell@elliotelectric.com ..... Quotations Manager Host Store: <b>Little Rock, AR #091</b>	M-F: 7am-5:30pm Sat: 8am-Noon 1715 South Knoxville Avenue Russellville, AR 72802
Terry .....479-747-2271	
<b>SEARCY</b> #089 PHONE: 501-368-0309 FAX: 501-368-0619	<b>24/7 CONTACTS</b>
Rick Debord ..... RickDebord@elliotelectric.com ..... Branch Manager Host Store: <b>Little Rock, AR #091</b>	M-F: 7am-5:30pm Sat: 8am-Noon 1612 East Booth Road Searcy, AR 72143
Rick .....501-831-3852	
<b>SILOAM SPRINGS</b> #126 PHONE: 479-238-1561 FAX: 479-238-1461	<b>24/7 CONTACTS</b>
Wesley Holt ..... WesleyHolt@elliotelectric.com ..... Branch Manager Host Store: <b>Springdale, AR #106</b>	M-F: 7am-5:30pm Sat: 8am-Noon 1201 East Lake Francis Drive Siloam Springs, AR 72761
Wesley .....479-644-0049	
<b>SPRINGDALE</b> #106 PHONE: 479-361-2266 FAX: 479-361-9188	<b>24/7 CONTACTS</b>
Jim Mitchell ..... JimMitchell@elliotelectric.com ..... Area Operations Manager Tina Priddy ..... TinaPriddy@elliotelectric.com ..... Branch Manager David Christenberry ..... DavidChristenberry@elliotelectric.com ..... Area Manager	M-F: 7am-5:30pm Sat: 8am-Noon 537 North 40th Street Springdale, AR 72762
Jim .....479-466-2884 Tina .....479-530-5276 David .....479-225-6948	
<b>STUTTGART</b> #107 PHONE: 870-672-7082 FAX: 870-672-7086	<b>24/7 CONTACTS</b>
Allen Bone ..... DavidBone@elliotelectric.com ..... Branch Manager Host Store: <b>Little Rock, AR #091</b>	M-F: 7am-5:30pm Sat: 8am-Noon 310 West 22nd Street Stuttgart, AR 72160
Allen .....501-804-2561	

### Georgia

<b>ATLANTA</b> #046 PHONE: 470-237-5352 FAX: 470-237-5353	<b>24/7 CONTACTS</b>
Kevin Dodson ..... KevinDodson@elliotelectric.com ..... Area Manager Eric Cook ..... EricCook@elliotelectric.com ..... Area Operations Manager	M-F: 7am-5:30pm Sat: 8am-Noon 4075 Bolder Ridge Drive Atlanta, GA 30336
Kevin .....713-298-5632 Eric .....214-738-5775	
<b>MARIETTA</b> #TBD PHONE: 678-398-4904 FAX: 678-398-4905	<b>24/7 CONTACTS</b>
Tim Adams ..... TimAdams@elliotelectric.com ..... Branch Manager Host Store: <b>Atlanta, GA #046</b>	M-F: 7am-5:30pm Sat: 8am-Noon 2255 Northwest Parkway SE Marietta, GA 30067
Tim .....404-904-9090	
<b>NEWMAN</b> #154 PHONE: 678-621-2507 FAX: 678-621-2508	<b>24/7 CONTACTS</b>
Jessica Durand ..... JessicaDurand@elliotelectric.com ..... Branch Manager Host Store: <b>Atlanta, GA #046</b>	M-F: 7am-5:30pm Sat: 8am-Noon 2 Solar Circle Newman, GA 30265
Jessica .....770-328-0836	
<b>ROME</b> #150 PHONE: 706-622-4953 FAX: 706-622-4954	<b>24/7 CONTACTS</b>
Jamen Costner ..... JamenCostner@elliotelectric.com ..... Branch Manager Host Store: <b>Atlanta, GA #046</b>	M-F: 7am-5:30pm Sat: 8am-Noon 1461 Technology Parkway Rome, GA 30165
Jamen .....706-204-4703	

### Kansas

<b>DODGE CITY</b> #TBD PHONE: 620-682-8503 FAX: 620-682-8504	<b>24/7 CONTACTS</b>
Bryan Mercer ..... BryanMercer@elliotelectric.com ..... Area Manager Isaiah Ortiz ..... IsaiahOrtiz@elliotelectric.com ..... Branch Manager Host Store: <b>Wichita (West), KS #146</b>	M-F: 7am-5:30pm Sat: 8am-Noon 122 Pearl Street Dodge City, KS 67801
Bryan .....806-336-0761 Isaiah .....806-717-8434	
<b>HUTCHINSON</b> #155 PHONE: 620-860-8405 FAX: 620-860-8406	<b>24/7 CONTACTS</b>
Alex Felix-Delgado ..... AlexFelix-Delgado@elliotelectric.com ..... Branch Manager Host Store: <b>Wichita (West), KS #146</b>	M-F: 7am-5:30pm Sat: 8am-Noon 2501 East 14th Avenue Hutchinson, KS 67501
Alex .....316-371-3329	
<b>WICHITA (CENTRAL)</b> #135 PHONE: 316-262-1446 FAX: 316-262-2242	<b>24/7 CONTACTS</b>
Robert Ahlgrim ..... RobertAhlgrim@elliotelectric.com ..... Branch Manager Bryan Mercer ..... BryanMercer@elliotelectric.com ..... Area Manager Host Store: <b>Wichita (West), KS #146</b>	M-F: 7am-5:30pm Sat: Closed 409 South Lulu Street Wichita, KS 67211
Robert .....316-409-6730 Bryan .....806-336-0761	



## Store Information: Kansas, Louisiana

## Kansas (cont.)

<b>WICHITA (WEST)</b>	<b>#146</b>	<b>PHONE: 316-854-0028</b>	<b>FAX: 316-854-0029</b>	<b>24/7 CONTACTS</b>
Bryan Mercer.....BryanMercer@elliottelectric.com.....Area Manager		M-F: 7am-5:30pm	4100 West Walker Street	Bryan.....806-336-0761
Hunter Rowland.....HunterRowland@elliottelectric.com.....Operations Manager		Sat: 8am-Noon	Wichita, KS 67209	Hunter.....316-737-8968

## Louisiana

<b>ALEXANDRIA</b>	<b>#054</b>	<b>PHONE: 318-445-1336</b>	<b>FAX: 318-445-8356</b>	<b>24/7 CONTACTS</b>
Johnny Winfree.....JohnnyWinfree@elliottelectric.com.....Area Manager		M-F: 7am-5:30pm	3705 Lee Street	Chris.....318-447-0378
Chris Rogers.....ChristopherRogers@elliottelectric.com.....Area Operations Manager		Sat: 8am-Noon	Alexandria, LA 71302	

<b>BATON ROUGE</b>	<b>#102</b>	<b>PHONE: 225-292-7746</b>	<b>FAX: 225-292-7840</b>	<b>24/7 CONTACTS</b>
Bob Jones.....BobJones@elliottelectric.com.....Host Manager		M-F: 6am-5:30pm	10440 Airline Highway	Bob.....225-620-8707
Karen Bennett.....KarenBennett@elliottelectric.com.....Operations Manager		Sat: 8am-Noon	Baton Rouge, LA 70816	

<b>BOSSIER CITY</b>	<b>#003</b>	<b>PHONE: 318-746-5712</b>	<b>FAX: 318-746-8036</b>	<b>24/7 CONTACTS</b>
Sharon Elliott.....SharonElliott@elliottelectric.com.....Area Manager		M-F: 7am-5:30pm	2414 Montgomery Lane	Sharon.....318-458-7157
Kyle Baker.....KyleBaker@elliottelectric.com.....Operations Manager		Sat: 8am-Noon	Bossier City, LA 71111	Kyle.....318-272-3251

<b>COVINGTON</b>	<b>#137</b>	<b>PHONE: 985-302-3016</b>	<b>FAX: 985-249-6076</b>	<b>24/7 CONTACTS</b>
JT Thompson.....JulianThompson@elliottelectric.com.....Branch Manager		M-F: 6am-5pm	1026 North Collins Boulevard	JT.....985-687-1110
Host Store: <b>Baton Rouge, LA #102</b>		Sat: 8am-Noon	Covington, LA 70433	

<b>LAFAYETTE</b>	<b>#059</b>	<b>PHONE: 337-235-7681</b>	<b>FAX: 337-235-7725</b>	<b>24/7 CONTACTS</b>
Dwight Dufour.....DwightDufour@elliottelectric.com.....Branch Manager		M-F: 7am-5:30pm	1811 N. University Ave., Ste. 100	Dwight.....337-534-7910
Host Store: <b>Alexandria, LA #054</b>		Sat: 8am-Noon	Lafayette, LA 70507	

<b>LEESVILLE</b>	<b>#057</b>	<b>PHONE: 337-238-1624</b>	<b>FAX: 337-239-2527</b>	<b>24/7 CONTACTS</b>
Heather Littleton.....HeatherLittleton@elliottelectric.com.....Branch Manager		M-F: 7am-5:30pm	206 Stanton Street	Heather.....337-353-6211
Host Store: <b>Alexandria, LA #054</b>		Sat: 8am-Noon	Leesville, LA 71446	

<b>MONROE</b>	<b>#079</b>	<b>PHONE: 318-387-1621</b>	<b>FAX: 318-387-1763</b>	<b>24/7 CONTACTS</b>
Van Phillips.....VanPhillips@elliottelectric.com.....Host Manager		M-F: 7am-5:30pm	801 Sterlington Road	Van.....318-557-5591
Host Store: <b>West Monroe, LA #055</b>		Sat: 8am-Noon	Monroe, LA 71203	

<b>NATCHITOCHE</b>	<b>#020</b>	<b>PHONE: 318-352-7414</b>	<b>FAX: 318-352-4100</b>	<b>24/7 CONTACTS</b>
Bobby Garlington.....BobbyGarlington@elliottelectric.com.....Branch Manager		M-F: 7am-5:30pm	500 Rapides Drive	Bobby.....318-332-0015
Host Store: <b>Alexandria, LA #054</b>		Sat: 8am-Noon	Natchitoches, LA 71457	

<b>NEW ORLEANS</b>	<b>#111</b>	<b>PHONE: 504-264-9995</b>	<b>FAX: 504-264-5996</b>	<b>24/7 CONTACTS</b>
Brett Windmann.....BrettWindmann@elliottelectric.com.....Branch Manager		M-F: 6am-5pm	221 Hord Street	Brett.....504-296-8837
Host Store: <b>Baton Rouge, LA #102</b>		Sat: 8am-Noon	Harahan, LA 70123	

<b>PINEVILLE</b>	<b>#035</b>	<b>PHONE: 318-767-0900</b>	<b>FAX: 318-767-0010</b>	<b>24/7 CONTACTS</b>
Lane Belgard.....LaneBelgard@elliottelectric.com.....Branch Manager		M-F: 7am-5:30pm	4406 Highway 28 East	Lane.....318-419-3815
Host Store: <b>Alexandria, LA #054</b>		Sat: 8am-Noon	Pineville, LA 71360	

<b>RUSTON</b>	<b>#067</b>	<b>PHONE: 318-251-9393</b>	<b>FAX: 318-255-1402</b>	<b>24/7 CONTACTS</b>
Corey Bordelon.....CoreyBordelon@elliottelectric.com.....Operations Manager		M-F: 7am-5:30pm	2020 Farmerville Highway	Corey.....318-230-4968
Host Store: <b>West Monroe, LA #055</b>		Sat: 8am-Noon	Ruston, LA 71270	

<b>SHREVEPORT</b>	<b>#014</b>	<b>PHONE: 318-688-9822</b>	<b>FAX: 318-688-0702</b>	<b>24/7 CONTACTS</b>
Terry Godfrey.....TerryGodfrey@elliottelectric.com.....Operations Manager		M-F: 7am-5:30pm	9139 Linwood Avenue	Terry.....318-464-2540
Host Store: <b>Bossier City, LA #003</b>		Sat: 8am-Noon	Shreveport, LA 71106	

<b>SULPHUR</b>	<b>#080</b>	<b>PHONE: 337-533-8019</b>	<b>FAX: 337-533-8055</b>	<b>24/7 CONTACTS</b>
Neil Peveto.....NeilPeveto@elliottelectric.com.....Branch Manager		M-F: 7am-5:30pm	1336 Swisco Road	Neil.....337-540-2842
Host Store: <b>Alexandria, LA #054</b>		Sat: 8am-Noon	Sulphur, LA 70665	

<b>VIDALIA</b>	<b>#074</b>	<b>PHONE: 318-336-5113</b>	<b>FAX: 318-336-5587</b>	<b>24/7 CONTACTS</b>
Van Phillips.....VanPhillips@elliottelectric.com.....Host Manager		M-F: 7am-5:30pm	6 South Hickory Street	Edward.....601-431-1944
Host Store: <b>Alexandria, LA #054</b>		Sat: 8am-Noon	Vidalia, LA 71373	Sammy.....601-660-8989



# ELLIOTT ELECTRIC SUPPLY

L29

## Store Information: Louisiana, New Mexico, Oklahoma

### Louisiana (cont.)

<b>WEST MONROE</b>	<b>#055</b>	<b>PHONE: 318-398-9757</b>	<b>FAX: 318-398-9704</b>	<b>24/7 CONTACTS</b>
Van Phillips ..... VanPhillips@elliottelectric.com ..... Host Manager		M-F: 7am-5:30pm	106 Industrial Drive	Van .....318-557-5591
Michael Jordan ..... MichaelJordan@elliottelectric.com ..... Operations Manager		Sat: 8am-Noon	West Monroe, LA 71292	

### New Mexico

<b>CARLSBAD</b>	<b>#156</b>	<b>PHONE: 575-988-7017</b>	<b>FAX: 575-988-7018</b>	<b>24/7 CONTACTS</b>	<b>NEW STORE!</b>
Michael Gideon ..... MichaelGideon@elliottelectric.com ..... Branch Manager		M-F: 7am-5:30pm	5004 National Parks Highway	Michael .....575-390-4354	
Keagan McDermett ..... KeaganMcDermett@elliottelectric.com ..... Host Manager		Sat: 8am-Noon	Carlsbad, NM 88220	Keagan .....806-831-1755	
Host Store: <b>Lubbock, TX #110</b>					

<b>CLOVIS</b>	<b>#092</b>	<b>PHONE: 575-742-2504</b>	<b>FAX: 575-742-2508</b>	<b>24/7 CONTACTS</b>	
David Chaney ..... DavidChaney@elliottelectric.com ..... Branch Manager		M-F: 7am-5:30pm	3205 Axtell Street	David .....325-277-7599	
Keagan McDermett ..... KeaganMcDermett@elliottelectric.com ..... Host Manager		Sat: 8am-Noon	Clovis, NM 88101	Keagan .....806-831-1755	
Host Store: <b>Lubbock, TX #110</b>					

<b>HOBBS</b>	<b>#076</b>	<b>PHONE: 575-397-2122</b>	<b>FAX: 575-397-2178</b>	<b>24/7 CONTACTS</b>
Mathew Mendez ..... MathewMendez@elliottelectric.com ..... Operations Manager		M-F: 7am-5:30pm	1105 West Sanger Street	Scott .....575-602-8416
Host Store: <b>Odessa, TX #066</b>		Sat: Closed	Hobbs, NM 88240	Mathew .....210-265-7793

<b>ROSWELL</b>	<b>#141</b>	<b>PHONE: 575-208-1571</b>	<b>FAX: 575-208-1572</b>	<b>24/7 CONTACTS</b>	
Keith Taylor ..... KeithTaylor@elliottelectric.com ..... Branch Manager		M-F: 7am-5:30pm	907 East 2nd Street	Keith .....806-676-4663	
Keagan McDermett ..... KeaganMcDermett@elliottelectric.com ..... Host Manager		Sat: 8am-Noon	Roswell, NM 88201	Keagan .....806-831-1755	
Host Store: <b>Lubbock, TX #110</b>					

### Oklahoma

<b>DUNCAN</b>	<b>#118</b>	<b>PHONE: 580-252-2582</b>	<b>FAX: 580-252-2738</b>	<b>24/7 CONTACTS</b>
Kody Rackley ..... JonathanRackley@elliottelectric.com ..... Branch Manager		M-F: 7am-5:30pm	5150 North Highway 81	Kody .....405-727-0326
Host Store: <b>Oklahoma City, OK #122</b>		Sat: 8am-Noon	Duncan, OK 73533	

<b>EDMOND</b>	<b>#128</b>	<b>PHONE: 405-562-6283</b>	<b>FAX: 405-562-6284</b>	<b>24/7 CONTACTS</b>	<b>NOW OPEN!</b>
Gary Mayes ..... GaryMayes@elliottelectric.com ..... Branch Manager		M-F: 7am-5:30pm	308 Centennial Boulevard	Gary .....806-570-6750	
Host Store: <b>Oklahoma City, OK #122</b>		Sat: 8am-Noon	Edmond, OK 73013		

<b>ENID</b>	<b>#133</b>	<b>PHONE: 580-701-6818</b>	<b>FAX: 580-234-5655</b>	<b>24/7 CONTACTS</b>
Jerrid Bramwell ..... JerridBramwell@elliottelectric.com ..... Branch Manager		M-F: 7am-5:30pm	3507 North Van Buren Bypass	Jerrid .....580-542-6920
Host Store: <b>Oklahoma City, OK #122</b>		Sat: 8am-Noon	Enid, OK 73701	

<b>LAWTON</b>	<b>#109</b>	<b>PHONE: 580-581-7270</b>	<b>FAX: 580-215-4548</b>	<b>24/7 CONTACTS</b>
Tanner Taliaferro ..... TannerTaliaferro@elliottelectric.com ..... Operations Manager		M-F: 7am-5:30pm	1010 SE 1st Street	Tanner .....580-585-0611
Host Store: <b>Oklahoma City, OK #122</b>		Sat: 8am-Noon	Lawton, OK 73501	

<b>MOORE</b>	<b>#132</b>	<b>PHONE: 405-759-4139</b>	<b>FAX: 405-237-1928</b>	<b>24/7 CONTACTS</b>
Stephen Sharp ..... StephenSharp@elliottelectric.com ..... Branch Manager		M-F: 7am-5:30pm	2101 South Eastern Avenue	Stephen .....405-479-4737
Host Store: <b>Oklahoma City, OK #122</b>		Sat: 8am-Noon	Moore, OK 73160	

<b>OKLAHOMA CITY</b>	<b>#122</b>	<b>PHONE: 405-896-3723</b>	<b>FAX: 405-272-3057</b>	<b>24/7 CONTACTS</b>
Chris Woodall ..... ChrisWoodall@elliottelectric.com ..... Area Manager		M-F: 7am-5:30pm	1300 South May Avenue	Chris .....806-570-6110
David Tanner ..... DavidTanner@elliottelectric.com ..... Area Operations Manager		Sat: 8am-Noon	Oklahoma City, OK 73108	David .....817-899-7990

<b>PRYOR</b>	<b>#162</b>	<b>PHONE: 918-803-0063</b>	<b>FAX: 918-803-0064</b>	<b>24/7 CONTACTS</b>	<b>NEW STORE!</b>
Chris Rozene ..... ChrisRozene@elliottelectric.com ..... Operations Manager		M-F: 7am-5:30pm	1215 2nd Street MAIP	Chris .....918-804-3557	
Host Store: <b>Tulsa, OK #134</b>		Sat: 8am-Noon	Pryor, OK 74361		

<b>STILLWATER</b>	<b>#147</b>	<b>PHONE: 405-880-8633</b>	<b>FAX: 405-880-8634</b>	<b>24/7 CONTACTS</b>
Darrel Johnson ..... DarrelJohnson@elliottelectric.com ..... Branch Manager		M-F: 7am-5:30pm	303 East Hamed Avenue	Darrel .....405-612-1783
Host Store: <b>Tulsa, OK #134</b>		Sat: 8am-Noon	Stillwater, OK 74075	

<b>TULSA</b>	<b>#134</b>	<b>PHONE: 918-948-7825</b>	<b>FAX: 918-835-8085</b>	<b>24/7 CONTACTS</b>	<b>MOVING STORE! MAY 2020</b>
David Christenberry ..... DavidChristenberry@elliottelectric.com ..... Area Manager		M-F: 7am-5:30pm	10131 East 21st Street	David .....479-225-6948	
Chris Rozene ..... ChrisRozene@elliottelectric.com ..... Operations Manager		Sat: 8am-Noon	Tulsa, OK 74129	Chris .....918-804-3557	

References



**Tennessee**

OPENING SOON!

<b>NASHVILLE</b>	<b>#TBD</b>	<b>PHONE: 629-262-0932</b>	<b>FAX: 692-262-0933</b>	<b>24/7 CONTACTS</b>
Blake Woods.....BlakeWoods@elliottelectric.com.....Area Manager		M-F: 7am-5:30pm Sat: 8am-Noon	3723 Keystone Avenue Nashville, TN 37211	Blake.....713-305-9185

**Texas**

<b>ABILENE</b>	<b>#058</b>	<b>PHONE: 325-793-1570</b>	<b>FAX: 325-692-9649</b>	<b>24/7 CONTACTS</b>
Bryson Walker.....BrysonWalker@elliottelectric.com.....Area Operations Manager		M-F: 7am-5:30pm Sat: 8am-Noon	4281 Crawford Drive Abilene, TX 79602	Bryson .....325-260-7354 James .....325-660-1730
James Meazell.....JamesMeazell@elliottelectric.com.....Area Manager				

<b>AMARILLO</b>	<b>#081</b>	<b>PHONE: 806-220-0404</b>	<b>FAX: 806-220-0811</b>	<b>24/7 CONTACTS</b>
Michael Lopez.....MichaelLopez@elliottelectric.com.....Host Manager		M-F: 7am-5:30pm Sat: 8am-Noon	4000 Mockingbird Lane Amarillo, TX 79109	Michael .....806-433-2472 Jered.....806-683-3000
Jered Prather.....JeredPrather@elliottelectric.com.....Operations Manager				

<b>ANDREWS</b>	<b>#070</b>	<b>PHONE: 432-523-2423</b>	<b>FAX: 432-523-2428</b>	<b>24/7 CONTACTS</b>
Tyler Jenkins.....TylerJenkins@elliottelectric.com.....Operations Manager		M-F: 7am-5:30pm Sat: Closed	1201 West Broadway Andrews, TX 79714	Tyler.....806-781-6891
Host Store: <b>Odessa, TX #066</b>				

<b>ARLINGTON</b>	<b>#012</b>	<b>PHONE: 817-695-1616</b>	<b>FAX: 817-633-9062</b>	<b>24/7 CONTACTS</b>
Santiago Martinez.....SantiagoMartinez@elliottelectric.com.....Branch Manager		M-F: 7am-5:30pm Sat: 8am-Noon	2900 East Pioneer Parkway Building 100, Suite 170 Arlington, TX 76010	Santiago .....469-600-0488 Rick .....936-715-5195
Rick Franklin.....RickFranklin@elliottelectric.com.....Operations Manager				
Host Store: <b>Dallas/Fort Worth (RDC), TX #034</b>				

<b>ATHENS</b>	<b>#024</b>	<b>PHONE: 903-675-7999</b>	<b>FAX: 903-675-9414</b>	<b>24/7 CONTACTS</b>
Dusty Godwin.....PaulGodwin@elliottelectric.com.....Branch Manager		M-F: 7am-5:30pm Sat: 8am-Noon	1755 Enterprise Street Athens, TX 75751	Dusty .....903-681-1468 Dwain.....903-677-5522
Dwain Johnson.....DwainJohnson@elliottelectric.com.....Operations Manager				
Host Store: <b>Tyler, TX #002</b>				

<b>AUSTIN (NORTH)</b>	<b>#120</b>	<b>PHONE: 512-351-3290</b>	<b>FAX: 512-973-9027</b>	<b>24/7 CONTACTS</b>
Shawn Ford.....ShawnFord@elliottelectric.com.....Branch Manager		M-F: 6am-5:30pm Sat: 8am-Noon	3101 Industrial Terrace, Suite 104 Austin, TX 78758	Shawn.....512-925-3208
Host Store: <b>Austin (RDC), TX #064</b>				

NEW ADDRESS

<b>AUSTIN (RDC)</b>	<b>#064</b>	<b>PHONE: 512-339-8750</b>	<b>FAX: 512-339-6732</b>	<b>24/7 CONTACTS</b>
Mike Hogan.....MikeHogan@elliottelectric.com.....Area Operations Manager		M-F: 6am-5:30pm Sat: 8am-Noon	12555 Harris Branch Pkwy., Ste. 105 Manor, TX 78653	Mike .....512-289-7149 Chris .....512-789-2679
Chris Petty.....ChrisPetty@elliottelectric.com.....Regional Manager				

<b>AUSTIN (SOUTH)</b>	<b>#053</b>	<b>PHONE: 512-443-5600</b>	<b>FAX: 512-443-5601</b>	<b>24/7 CONTACTS</b>
Adam Parker.....AdamParker@elliottelectric.com.....Branch Manager		M-F: 7am-5:30pm Sat: 8am-Noon	2301 E Saint Elmo Road, Ste. 105 Austin, TX 78744	Adam .....512-999-8383
Host Store: <b>Austin (RDC), TX #064</b>				

<b>BASTROP</b>	<b>#145</b>	<b>PHONE: 512-772-2493</b>	<b>FAX: 512-772-2494</b>	<b>24/7 CONTACTS</b>
Blaine Williams.....BlaineWilliams@elliottelectric.com.....Branch Manager		M-F: 7am-5:30pm Sat: 8am-Noon	405 Technology Drive Bastrop, TX 78602	Blaine.....979-716-2744
Host Store: <b>Austin (RDC), TX #064</b>				

<b>BIG SPRING</b>	<b>#101</b>	<b>PHONE: 432-264-0316</b>	<b>FAX: 432-264-0483</b>	<b>24/7 CONTACTS</b>
Jamie Roberts.....JamieRoberts@elliottelectric.com.....Operations Manager		M-F: 7am-5:30pm Sat: Closed	1308 East 4th Street Big Spring, TX 79720	Jamie .....432-270-2387
Host Store: <b>Odessa, TX #066</b>				

<b>BORGER</b>	<b>#075</b>	<b>PHONE: 806-273-3085</b>	<b>FAX: 806-273-2487</b>	<b>24/7 CONTACTS</b>
Austin Boyd.....AustinBoyd@elliottelectric.com.....Branch Manager		M-F: 7am-5:30pm Sat: 8am-Noon	2108 South Huber Borger, TX 79007	Austin.....806-930-0510
Host Store: <b>Amarillo, TX #081</b>				

<b>BRIDGEPORT</b>	<b>#023</b>	<b>PHONE: 940-683-5740</b>	<b>FAX: 940-683-5299</b>	<b>24/7 CONTACTS</b>
Heath Sparks.....JamesSparks@elliottelectric.com.....Branch Manager		M-F: 7am-5:30pm Sat: 8am-Noon	204 Lake Road Bridgeport, TX 76426	Heath.....214-914-7438
Host Store: <b>Dallas/Fort Worth (RDC), TX #034</b>				

NOW OPEN!

<b>BROWNSVILLE</b>	<b>#151</b>	<b>PHONE: 956-295-3007</b>	<b>FAX: 956-295-3008</b>	<b>24/7 CONTACTS</b>
Lance Shelley.....LanceShelley@elliottelectric.com.....Branch Manager		M-F: 7am-5:30pm Sat: 8am-Noon	5575 Ruben M Torres Boulevard Brownsville, TX 78526	Lance.....512-656-0084 JD .....956-372-8030
JD Cardenas.....JesusCardenas@elliottelectric.com.....Operations Manager				
Host Store: <b>McAllen, TX #144</b>				

References





# ELLIOTT ELECTRIC SUPPLY

L31

## Store Information: Texas

### Texas (cont.)

<b>BROWNWOOD</b>		<b>#027</b>	<b>PHONE: 325-646-6566</b>	<b>FAX: 325-646-3777</b>	<b>24/7 CONTACTS</b>
Ross Neel .....	RossNeel@elliottelectric.com .....	Branch Manager	M-F: 7am-5:30pm	4300 Danhill Drive	Ross .....325-660-4658
Jacob Teague .....	JacobTeague@elliottelectric.com .....	Operations Manager	Sat: 8am-Noon	Brownwood, TX 76801	Jacob .....325-203-0474
Host Store: <b>Dallas/Fort Worth (RDC), TX #034</b>					
<b>BRYAN</b>		<b>#047</b>	<b>PHONE: 979-779-6630</b>	<b>FAX: 979-779-6620</b>	<b>24/7 CONTACTS</b>
Quentin Risner .....	QuentinRisner@elliottelectric.com .....	Branch Manager	M-F: 7am-5:30pm	2501 Cavitt Avenue	Quentin .....936-554-0313
Host Store: <b>Houston (RDC), TX #049</b>			Sat: 8am-Noon	Bryan, TX 77801	
<b>BURLESON</b>		<b>#040</b>	<b>PHONE: 817-447-0192</b>	<b>FAX: 817-426-1193</b>	<b>24/7 CONTACTS</b>
Louis Perkins .....	LouisPerkins@elliottelectric.com .....	Branch Manager	M-F: 7am-5:30pm	149 North Wilson Street	Louis .....817-253-2212
Host Store: <b>Dallas/Fort Worth (RDC), TX #034</b>			Sat: 8am-Noon	Burleson, TX 76028	
<b>CARTHAGE</b>		<b>#068</b>	<b>PHONE: 903-694-9924</b>	<b>FAX: 903-694-9928</b>	<b>24/7 CONTACTS</b>
Nathan Lenox .....	NathanLenox@elliottelectric.com .....	Branch Manager	M-F: 7am-5:30pm	3168 SW Loop 436	Nathan .....903-692-4832
Host Store: <b>Nacogdoches, TX #001</b>			Sat: Closed	Carthage, TX 75633	
<b>CEDAR PARK</b>		<b>#051</b>	<b>PHONE: 512-260-0684</b>	<b>FAX: 512-260-7269</b>	<b>24/7 CONTACTS</b>
Kody King .....	KodyKing@elliottelectric.com .....	Branch Manager	M-F: 6am-5:30pm	300 East New Hope Road	Kody .....512-567-2927
Michael Tollett .....	MichaelTollett@elliottelectric.com .....	Operations Manager	Sat: 8am-Noon	Cedar Park, TX 78613	Michael .....254-592-5511
Host Store: <b>Austin (RDC), TX #064</b>					
<b>CLEBURNE</b>		<b>#116</b>	<b>PHONE: 817-202-8933</b>	<b>FAX: 817-202-8998</b>	<b>24/7 CONTACTS</b>
Louis Perkins .....	LouisPerkins@elliottelectric.com .....	Branch Manager	M-F: 7am-5:30pm	1820 North Main Street	Louis .....817-253-2212
Host Store: <b>Dallas/Fort Worth (RDC), TX #034</b>			Sat: 8am-Noon	Cleburne, TX 76033	
<b>CONROE</b>		<b>#069</b>	<b>PHONE: 936-788-6850</b>	<b>FAX: 936-788-8283</b>	<b>24/7 CONTACTS</b>
Jason Renfrow .....	JasonRenfrow@elliottelectric.com .....	Branch Manager	M-F: 7am-5:30pm	2323 North Frazier, Suite F	Jason .....281-330-0070
Devin Ray .....	DevinRay@elliottelectric.com .....	Operations Manager	Sat: 8am-Noon	Suite 308	Devin .....936-232-8111
Host Store: <b>Houston (RDC), TX #049</b>					
<b>CORSICANA</b>		<b>#031</b>	<b>PHONE: 903-872-9696</b>	<b>FAX: 903-872-9980</b>	<b>24/7 CONTACTS</b>
Patrick McGuire .....	PatrickMcGuire@elliottelectric.com .....	Branch Manager	M-F: 7am-5:30pm	1732 South Business 287	Patrick .....903-641-2993
Host Store: <b>Dallas/Fort Worth (RDC), TX #034</b>			Sat: 8am-Noon	Corsicana, TX 75110	
<b>DALLAS (EAST)</b>		<b>#006</b>	<b>PHONE: 214-503-7227</b>	<b>FAX: 214-503-9766</b>	<b>24/7 CONTACTS</b>
Lance Knight .....	LanceKnight@elliottelectric.com .....	Branch Manager	M-F: 6am-5:30pm	3737 Grader Street, Suite #120	Lance .....972-333-8618
Michael Lipsey .....	MichaelLipsey@elliottelectric.com .....	Operations Manager	Sat: 8am-Noon	Garland, TX 75041	Michael .....713-213-4439
Host Store: <b>Dallas/Fort Worth (RDC), TX #034</b>					
<b>DALLAS/FORT WORTH (RDC)</b>		<b>#034</b>	<b>PHONE: 972-206-0016</b>	<b>FAX: 972-352-2818</b>	<b>24/7 CONTACTS</b>
Doug Blevins .....	DougBlevins@elliottelectric.com .....	Area Manager	M-F: 7am-5:30pm	13405 Stemmons Freeway	Doug .....214-497-2562
Taylor Kulovitz .....	TaylorKulovitz@elliottelectric.com .....	Area Operations Manager	Sat: 8am-Noon	Farmers Branch, TX 75234	Taylor .....469-688-6178
<b>DALLAS (WEST)</b>		<b>#018</b>	<b>PHONE: 214-351-0785</b>	<b>FAX: 972-241-1564</b>	<b>24/7 CONTACTS</b>
Lance Knight .....	LanceKnight@elliottelectric.com .....	Branch Manager	M-F: 7am-5:30pm	13405 Stemmons Freeway	Lance .....972-333-8618
Matthew Fritsche .....	MatthewFritsche@elliottelectric.com .....	Operations Manager	Sat: 8am-Noon	Farmers Branch, TX 75234	Matthew .....979-571-1121
Host Store: <b>Dallas/Fort Worth (RDC), TX #034</b>					
<b>DEER PARK</b>		<b>#130</b>	<b>PHONE: 281-220-3780</b>	<b>FAX: 713-740-6104</b>	<b>24/7 CONTACTS</b>
Casey McIver .....	CaseyMcIver@elliottelectric.com .....	Branch Manager	M-F: 7am-5:30pm	3700 Highway 225, Suite 100	Casey .....281-772-7761
Steve King .....	SteveKing@elliottelectric.com .....	Operations Manager	Sat: 8am-Noon	Pasadena, TX 77503	Steve .....832-580-0055
<b>DENTON</b>		<b>#019</b>	<b>PHONE: 940-381-9070</b>	<b>FAX: 940-380-0325</b>	<b>24/7 CONTACTS</b>
Austin Fitzgerald .....	AustinFitzgerald@elliottelectric.com .....	Branch Manager	M-F: 7am-5:30pm	4221 Mesa Drive	Austin .....281-415-8757
Host Store: <b>Dallas/Fort Worth (RDC), TX #034</b>			Sat: 8am-Noon	Denton, TX 76207	Jordan .....940-231-1523
<b>DUMAS</b>		<b>#085</b>	<b>PHONE: 806-934-4805</b>	<b>FAX: 806-717-2052</b>	<b>24/7 CONTACTS</b>
Austin Boyd .....	AustinBoyd@elliottelectric.com .....	Branch Manager	M-F: 7am-5:30pm	110 Success Boulevard	Austin .....806-930-0510
Host Store: <b>Amarillo, TX #081</b>			Sat: 8am-Noon	Dumas, TX 79029	
<b>ENNIS</b>		<b>#044</b>	<b>PHONE: 972-875-3413</b>	<b>FAX: 972-875-3174</b>	<b>24/7 CONTACTS</b>
Shannon Lott .....	ShannonLott@elliottelectric.com .....	Branch Manager	M-F: 7am-5:30pm	711 Lake Bardwell Drive	Shannon .....972-217-6006
Host Store: <b>Dallas/Fort Worth (RDC), TX #034</b>			Sat: 8am-Noon	Ennis, TX 75119	

NEW ADDRESS

References



## Store Information: Texas

## Texas (cont.)

<b>FORT STOCKTON</b>	<b>#087</b>	<b>PHONE: 432-336-8730</b>	<b>FAX: 432-336-3279</b>	<b>24/7 CONTACTS</b>
William Tucker.....WilliamTucker@elliottelectric.com.....Operations Manager Host Store: <b>Odessa, TX #066</b>		M-F: 7am-5:30pm Sat: 8am-Noon	1308 North Nelson Street Fort Stockton, TX 79735	William.....903-456-1387

<b>FORT WORTH (EAST)</b>	<b>#025</b>	<b>PHONE: 682-647-1594</b>	<b>FAX: 682-647-1528</b>	<b>24/7 CONTACTS</b>
Cody Sears.....CodySears@elliottelectric.com.....Branch Manager Todd Lantz.....ToddLantz@elliottelectric.com.....Operations Manager Host Store: <b>Dallas/Fort Worth (RDC), TX #034</b>		M-F: 7am-5:30pm Sat: 8am-Noon	6312A Airport Freeway Fort Worth, TX 76117	Cody.....817-271-9614 Todd.....817-320-4090

<b>NEW ADDRESS</b>	<b>FORT WORTH (WEST)</b>	<b>#121</b>	<b>PHONE: 817-560-0585</b>	<b>FAX: 817-560-0723</b>	<b>24/7 CONTACTS</b>
	Cody Sears.....CodySears@elliottelectric.com.....Branch Manager Scott Ewing.....ScottEwing@elliottelectric.com.....Operations Manager Host Store: <b>Dallas/Fort Worth (RDC), TX #034</b>		M-F: 7am-5:30pm Sat: 8am-Noon	9651 Camp Bowie W. Boulevard Fort Worth, TX 76116	Cody.....817-271-9614 Scott.....817-538-4131

<b>GAINESVILLE</b>	<b>#083</b>	<b>PHONE: 940-612-1388</b>	<b>FAX: 940-612-1499</b>	<b>24/7 CONTACTS</b>
John Carr.....JohnCarr@elliottelectric.com.....Branch Manager Host Store: <b>Dallas/Fort Worth (RDC), TX #034</b>		M-F: 7am-5:30pm Sat: 8am-Noon	1725 East Highway 82 Gainesville, TX 76240	John.....940-395-4124

<b>GALENA PARK</b>	<b>#017</b>	<b>PHONE: 713-675-6700</b>	<b>FAX: 713-675-6777</b>	<b>24/7 CONTACTS</b>
Casey McIver.....CaseyMcIver@elliottelectric.com.....Branch Manager Joe Lopez.....JoeLopez@elliottelectric.com.....Operations Manager Host Store: <b>Deer Park, TX #130</b>		M-F: 7am-5:30pm Sat: 8am-Noon	1915 Turning Basin Suite 500 Houston, TX 77029	Casey.....281-772-7761 Joe.....832.641.3686

<b>GALVESTON</b>	<b>#100</b>	<b>PHONE: 409-741-0072</b>	<b>FAX: 409-741-0433</b>	<b>24/7 CONTACTS</b>
Ricky Butts.....RickyButts@elliottelectric.com.....Branch Manager Host Store: <b>Deer Park, TX #130</b>		M-F: 7am-5:30pm Sat: 8am-Noon	6510 Broadway Street Galveston, TX 77554	Ricky.....832-506-2883

<b>GEORGETOWN</b>	<b>#136</b>	<b>PHONE: 737-444-2615</b>	<b>FAX: 737-444-2617</b>	<b>24/7 CONTACTS</b>
Kody King.....KodyKing@elliottelectric.com.....Branch Manager Brady Crenwelge.....BradyCrenwelge@elliottelectric.com.....Operations Manager Host Store: <b>Austin (RDC), TX #064</b>		M-F: 6am-5:30pm Sat: 8am-Noon	2450 NE Inner Loop, Building 1 Georgetown, TX 78626	Kody.....512-567-2927 Brady.....512-971-2625

<b>GRANBURY</b>	<b>#050</b>	<b>PHONE: 817-573-0675</b>	<b>FAX: 817-573-0776</b>	<b>24/7 CONTACTS</b>
Shannon Lott.....ShannonLott@elliottelectric.com.....Branch Manager Host Store: <b>Dallas/Fort Worth (RDC), TX #034</b>		M-F: 7am-5:30pm Sat: 8am-Noon	4510 East Highway 377 Granbury, TX 76049	Shannon.....972-217-6006

<b>GREENVILLE</b>	<b>#011</b>	<b>PHONE: 903-454-3354</b>	<b>FAX: 903-454-8926</b>	<b>24/7 CONTACTS</b>
Chad Oats.....ChadOats@elliottelectric.com.....Branch Manager Eric McCormack.....EricMcCormack@elliottelectric.com.....Operations Manager Host Store: <b>Tyler, TX #002</b>		M-F: 7am-5:30pm Sat: 8am-Noon	2805 Poplar Avenue Greenville, TX 75401	Chad.....214-908-7716 Eric.....903-366-6328

<b>HENDERSON</b>	<b>#005</b>	<b>PHONE: 903-657-1517</b>	<b>FAX: 903-657-0253</b>	<b>24/7 CONTACTS</b>
Nathan Lenox.....NathanLenox@elliottelectric.com.....Branch Manager Host Store: <b>Nacogdoches, TX #001</b>		M-F: 7am-5:30pm Sat: Closed	802 West Main Street Henderson, TX 75652	Nathan.....903-692-4832

<b>HEREFORD</b>	<b>#090</b>	<b>PHONE: 806-364-1529</b>	<b>FAX: 806-364-1540</b>	<b>24/7 CONTACTS</b>
Chad Perry.....ChadPerry@elliottelectric.com.....Operations Manager Host Store: <b>Amarillo, TX #081</b>		M-F: 7am-5:30pm Sat: 8am-Noon	401 E. 2nd Street Hereford, TX 79045	Chad.....806-847-7641

<b>HOUSTON (NORTHWEST)</b>	<b>#108</b>	<b>PHONE: 713-462-9901</b>	<b>FAX: 713-462-4509</b>	<b>24/7 CONTACTS</b>
Todd Pistor.....ToddPistor@elliottelectric.com.....Branch Manager Host Store: <b>Houston (RDC), TX #049</b>		M-F: 7am-5:30pm Sat: 8am-Noon	8401 Westland West Boulevard Houston, TX 77041	Todd.....281-635-8310

<b>HOUSTON (RDC)</b>	<b>#049</b>	<b>PHONE: 281-345-1143</b>	<b>FAX: 281-345-7697</b>	<b>24/7 CONTACTS</b>
Greg Fitzgerald.....GregFitzgerald@elliottelectric.com.....Regional Manager Shane Sampson.....ShaneSampson@elliottelectric.com.....Area Manager Brian Combs.....BrianCombs@elliottelectric.com.....Operations Manager		M-F: 7am-5:30pm Sat: 8am-Noon	8401 Westland West Boulevard Houston, TX 77041	Greg.....832-689-7460 Shane.....832-309-7342 Brian.....713-927-4812

<b>HUMBLE</b>	<b>#033</b>	<b>PHONE: 281-548-0169</b>	<b>FAX: 281-548-0198</b>	<b>24/7 CONTACTS</b>
Jason Renfrow.....JasonRenfrow@elliottelectric.com.....Branch Manager Eddie Martinez.....EddieMartinez@elliottelectric.com.....Operations Manager Host Store: <b>Deer Park, TX #130</b>		M-F: 7am-5:30pm Sat: 8am-Noon	1550 Wilson Road Humble, TX 77338	Jason.....281-330-0070 Eddie.....832-741-1847



# ELLIOTT ELECTRIC SUPPLY

L33

## Store Information: Texas

### Texas (cont.)

<b>HUNTSVILLE</b>		<b>#010</b>	<b>PHONE: 936-439-0658</b>	<b>FAX: 936-439-9182</b>	<b>24/7 CONTACTS</b>
Tim Watkins ..... TimWatkins@elliottelectric.com ..... Branch Manager	M-F: 7am-5:30pm	402 Hwy 190 East			Tim.....832-423-3682
Host Store: <b>Houston (RDC), TX #049</b>	Sat: On Call 8-Noon	Huntsville, TX 75740			
<b>JACKSONVILLE</b>		<b>#015</b>	<b>PHONE: 903-586-2904</b>	<b>FAX: 903-586-5271</b>	<b>24/7 CONTACTS</b>
Mark Lusk ..... MarkLusk@elliottelectric.com ..... Branch Manager	M-F: 7am-5:30pm	2202 East Rusk Street			Mark.....903-520-4359
Host Store: <b>Nacogdoches, TX #001</b>	Sat: 8am-Noon	Jacksonville, TX 75766			
<b>JASPER</b>		<b>#032</b>	<b>PHONE: 409-489-0056</b>	<b>FAX: 409-489-0059</b>	<b>24/7 CONTACTS</b>
Richard Barnhart ..... RichardBarnhart@elliottelectric.com ..... Branch Manager	M-F: 7am-5:30pm	430 South Fletcher Street			Richard .....409-594-9164
Host Store: <b>Nacogdoches, TX #001</b>	Sat: 8am-Noon	Jasper, TX 75951			
<b>KATY</b>		<b>#038</b>	<b>PHONE: 281-828-2012</b>	<b>FAX: 281-828-2512</b>	<b>24/7 CONTACTS</b>
Jason Nevill ..... JasonNevill@elliottelectric.com ..... Branch Manager	M-F: 7am-5:30pm	1722 Primewest Parkway			Jason .....281-989-9322
Phillip Bragg ..... PhillipBragg@elliottelectric.com ..... Operations Manager	Sat: 8am-Noon	Katy, TX 77449			Phillip.....832-428-1823
Host Store: <b>Houston (RDC), TX #049</b>					
<b>KENEDY</b>		<b>#119</b>	<b>PHONE: 830-299-4593</b>	<b>FAX: 830-583-9886</b>	<b>24/7 CONTACTS</b>
Ross Wendele ..... RossWendele@elliottelectric.com ..... Branch Manager	M-F: 7am-5:30pm	475 Boardwalk			Ross .....254-285-8565
Host Store: <b>San Antonio (RDC), TX #073</b>	Sat: 8am-Noon	Kenedy, TX 78119			
<b>KERRVILLE</b>		<b>#082</b>	<b>PHONE: 830-896-9240</b>	<b>FAX: 830-896-9244</b>	<b>24/7 CONTACTS</b>
Chadd Smart ..... ChaddSmart@elliottelectric.com ..... Branch Manager	M-F: 7am-5:30pm	1200 Water Street			Chadd.....830-708-9926
Host Store: <b>San Antonio (RDC), TX #073</b>	Sat: 8am-Noon	Kerrville, TX 78028			
<b>KILGORE</b>		<b>#013</b>	<b>PHONE: 903-984-8485</b>	<b>FAX: 903-984-8193</b>	<b>24/7 CONTACTS</b>
Jeffrey Lester ..... JeffreyLester@elliottelectric.com ..... Branch Manager	M-F: 7am-5:30pm	1207 Energy Drive			Jeffrey.....903-985-3478
Host Store: <b>Longview, TX #016</b>	Sat: 8am-Noon	Kilgore, TX 75662			
<b>KILLEEN</b>		<b>#048</b>	<b>PHONE: 254-554-5958</b>	<b>FAX: 254-554-8423</b>	<b>24/7 CONTACTS</b>
Kellen Ducey ..... KellenDucey@elliottelectric.com ..... Branch Manager	M-F: 7am-5:30pm	2501 South Fort Hood Street			Kellen.....254-458-2204
Host Store: <b>Austin (RDC), TX #064</b>	Sat: 8am-Noon	Killeen, TX 76542			
<b>LANCASTER</b>		<b>#158</b>	<b>PHONE: 469-913-1947</b>	<b>FAX: 469-913-1948</b>	<b>24/7 CONTACTS</b>
Santiago Martinez ..... SantiagoMartinez@elliottelectric.com ..... Branch Manager	M-F: 6:30am-5pm	1810 North Interstate 35 E			Santiago .....469-600-0488
Bruce Wilhelm ..... BruceWilhelm@elliottelectric.com ..... Operations Manager	Sat: 8am-Noon	Lancaster, TX 75134			Bruce .....940-733-7481
Host Store: <b>DFW (RDC), TX #034</b>					
<b>LEAGUE CITY</b>		<b>#056</b>	<b>PHONE: 281-833-5333</b>	<b>FAX: 281-833-5334</b>	<b>24/7 CONTACTS</b>
Ricky Butts ..... RickyButts@elliottelectric.com ..... Branch Manager	M-F: 7am-5:30pm	1135 Butler Road			Ricky.....832-506-2883
Host Store: <b>Deer Park, TX #130</b>	Sat: 8am-Noon	League City, TX 77573			
<b>LONGVIEW</b>		<b>#016</b>	<b>PHONE: 903-757-8491</b>	<b>FAX: 903-758-0441</b>	<b>24/7 CONTACTS</b>
Jerry Camp ..... JerryCamp@elliottelectric.com ..... Area Manager	M-F: 7am-5:30pm	1500 West Cotton Street			Jerry.....903-557-0963
Steve Coots ..... SteveCoots@elliottelectric.com ..... Operations Manager	Sat: 8am-Noon	Longview, TX 75604			Steve .....903-720-4327
<b>LUBOCK</b>		<b>#110</b>	<b>PHONE: 806-698-6329</b>	<b>FAX: 806-698-6805</b>	<b>24/7 CONTACTS</b>
Keetha Lucero ..... KeethaLucero@elliottelectric.com ..... Operations Manager	M-F: 7am-5:30pm	6112 42nd Street			Keetha .....806-241-5629
Keagan McDermott ..... KeaganMcDermott@elliottelectric.com ..... Host Manager	Sat: 8am-Noon	Lubbock, TX 79407			Keagan .....806-831-1755
<b>LUFKIN</b>		<b>#022</b>	<b>PHONE: 936-632-9733</b>	<b>FAX: 936-632-9736</b>	<b>24/7 CONTACTS</b>
Michael Cates ..... MichaelCates@elliottelectric.com ..... Branch Manager	M-F: 7am-5:30pm	2001 Atkinson Drive			Michael .....936-675-0880
Host Store: <b>Nacogdoches, TX #001</b>	Sat: 8am-Noon	Lufkin, TX 75901			
<b>MANSFIELD</b>		<b>#071</b>	<b>PHONE: 682-518-7272</b>	<b>FAX: 682-518-7255</b>	<b>24/7 CONTACTS</b>
Brett Church ..... BrettChurch@elliottelectric.com ..... Branch Manager	M-F: 7am-5:30pm	1501 Heritage Pkwy, Suite 101			Brett.....817-681-1690
Host Store: <b>Dallas/Fort Worth (RDC), TX #034</b>	Sat: 8am-Noon	Mansfield, TX 76063			
<b>MARBLE FALLS</b>		<b>#036</b>	<b>PHONE: 830-693-9910</b>	<b>FAX: 830-693-0544</b>	<b>24/7 CONTACTS</b>
Orion Barry ..... OrionBarry@elliottelectric.com ..... Branch Manager	M-F: 7am-5:30pm	608 Industrial Boulevard			Orion.....512-525-4380
Host Store: <b>Austin (RDC), TX #064</b>	Sat: 8am-Noon	Marble Falls, TX 78654			

NEW STORE!

References



Store Information: Texas

Texas (cont.)

<b>MARSHALL #008 PHONE: 903-935-9535 FAX: 903-935-3490</b>				<b>24/7 CONTACTS</b>
Eric Sparks .....EricSparks@elliottelectric.com.....Branch Manager		M-F: 7am-5:30pm	210 Veterans Avenue	Eric .....318-751-5923
Host Store: Longview, TX #016		Sat: 8am-Noon	Marshall, TX 75672	
<b>MCALEN #144 PHONE: 956-331-2410 FAX: 956-331-2411</b>				<b>24/7 CONTACTS</b>
Lance Shelley .....LanceShelley@elliottelectric.com.....Branch Manager		M-F: 7am-5:30pm	1701 North Jackson, Suite E	Lance .....512-656-0084
Rodrigo Alvarado .....RodrigoAlvarado@elliottelectric.com.....Operations Manager		Sat: 8am-Noon	McAllen, TX 78501	Rodrigo .....956-325-6434
<b>MCKINNEY #043 PHONE: 972-542-1196 FAX: 972-542-2279</b>				<b>24/7 CONTACTS</b>
Jenny Martin .....JenniferMartin@elliottelectric.com.....Branch Manager		M-F: 7am-5:30pm	427 Metro Park Drive	Jenny .....214-725-4983
Rich Correia .....RichCorreia@elliottelectric.com.....Operations Manager		Sat: 8am-Noon	McKinney, TX 75071	Rich .....469-323-5290
Host Store: Dallas/Fort Worth (RDC), TX #034				
<b>MIDLAND #062 PHONE: 432-685-3108 FAX: 432-685-3706</b>				<b>24/7 CONTACTS</b>
Braulio Bueno .....BraulioBueno@elliottelectric.com.....Operations Manager		M-F: 7am-5:30pm	1001 South Goode Street	Braulio .....432-847-7678
Bryson Walker .....BrysonWalker@elliottelectric.com.....Area Operations Manager		Sat: 8am-Noon	Midland, TX 79701	Bryson .....325-260-7354
Host Store: Odessa, TX #066				
<b>MINERAL WELLS #095 PHONE: 940-325-5503 FAX: 940-325-5544</b>				<b>24/7 CONTACTS</b>
Lee Robinson .....LeeRobinson@elliottelectric.com.....Branch Manager		M-F: 7am-5:30pm	201 North East 20th Avenue	Lee .....817-597-0847
Host Store: Dallas/Fort Worth (RDC), TX #034		Sat: 8am-Noon	Mineral Wells, TX 76067	
<b>MOUNT PLEASANT #021 PHONE: 903-577-7311 FAX: 903-577-7320</b>				<b>24/7 CONTACTS</b>
Robert Daniel .....RobertDaniel@elliottelectric.com.....Branch Manager		M-F: 7am-5:30pm	1121 West 16th Street	Robert .....903-440-0907
Host Store: Tyler, TX #002		Sat: 8am-Noon	Mt. Pleasant, TX 75455	Jason .....903-466-9075
NEW ADDRESS	<b>NACOGDOCHES #001 PHONE: 936-569-7941 FAX: 936-560-4685</b>			
	Jerry Camp .....JerryCamp@elliottelectric.com.....Area Manager		M-F: 7am-5:30pm	2310 North Stallings Drive
	Allen Watson .....AllenWatson@elliottelectric.com.....Operations Manager		Sat: 8am-Noon	Nacogdoches, TX 75964
	Host Store: Nacogdoches, TX #001			Allen .....936-552-1122
				Jerry .....903-557-0963
NEW STORE	<b>NAC LIGHTING SHOWROOM #161 PHONE: 936-585-8641 FAX: 936-585-8642</b>			
	Susan Hardesty .....SusanHardesty@elliottelectric.com.....Showroom Manager		M-F: 7am-5:30pm	2310 North Stallings Drive
	Host Store: Nacogdoches, TX #001		Sat: 8am-Noon	Nacogdoches, TX 75964
				Susan .....936-240-9320
<b>NEW BRAUNFELS #060 PHONE: 830-626-6880 FAX: 830-626-8075</b>				<b>24/7 CONTACTS</b>
Greg Hayes .....GregHayes@elliottelectric.com.....Branch Manager		M-F: 7am-5:30pm	212 Lucinda Drive	Greg .....830-214-5096
Host Store: San Antonio RDC, TX #073		Sat: 8am-Noon	New Braunfels, TX 78130	
<b>ODESSA #066 PHONE: 432-366-0008 FAX: 432-366-6045</b>				<b>24/7 CONTACTS</b>
Johnny Busick .....JohnnyBusick@elliottelectric.com.....Branch Manager		M-F: 7am-5:30pm	5617 Andrews Highway	Johnny .....432-967-2059
Bryson Walker .....BrysonWalker@elliottelectric.com.....Area Operations Manager		Sat: 8am-Noon	Odessa, TX 79762	Bryson .....325-260-7354
<b>PALESTINE #007 PHONE: 903-723-2141 FAX: 903-723-1451</b>				<b>24/7 CONTACTS</b>
Mark Lusk .....MarkLusk@elliottelectric.com.....Branch Manager		M-F: 7am-5:30pm	1620 Highway 155	Mark .....903-520-4359
Host Store: Nacogdoches, TX #001		Sat: 8am-Noon	Palestine, TX 75803	
NEW STORE	<b>PAMPA #140 PHONE: 806-665-0433 FAX: 806-665-1002</b>			
	Austin Boyd .....AustinBoyd@elliottelectric.com.....Branch Manager		M-F: 7am-5:30pm	1620 Alcock Street
	Host Store: Amarillo, TX #81		Sat: 8am-Noon	Pampa, TX 79065
				Austin .....806-930-0510
<b>PARIS #039 PHONE: 903-784-1916 FAX: 903-784-0107</b>				<b>24/7 CONTACTS</b>
Brian Monk .....BrianMonk@elliottelectric.com.....Branch Manager		M-F: 7am-5:30pm	3315 Park Place	Brian .....903-348-3524
John Cunningham .....JohnCunningham@elliottelectric.com.....Operations Manager		Sat: 8am-Noon	Paris, TX 75462	John .....903-401-1994
Host Store: Tyler, TX #002				
<b>PEARLAND #041 PHONE: 281-412-7049 FAX: 281-412-7314</b>				<b>24/7 CONTACTS</b>
Raymond Gutierrez .....RaymondGutierrez@elliottelectric.com.....Branch Manager		M-F: 7am-5:30pm	3222 Manvel Road	Raymond .....713-505-4860
Brian Combs .....BrianCombs@elliottelectric.com.....Area Operations Manager		Sat: 8am-Noon	Pearland, TX 77584	Brian .....713-927-4812
Host Store: Deer Park, TX #130				
<b>PEARSALL #127 PHONE: 830-334-5353 FAX: 830-334-5757</b>				<b>24/7 CONTACTS</b>
Julian Garcia .....JulianGarcia@elliottelectric.com.....Branch Manager		M-F: 7am-5:30pm	1910 Business Interstate 35E	Julian .....210-213-5622
Host Store: San Antonio RDC, TX #073		Sat: 8am-Noon	Pearsall, TX 78061	Beau .....337-718-1868



# ELLIOTT ELECTRIC SUPPLY

L35

## Store Information: Texas

### Texas (cont.)

<b>PECOS</b>	<b>#117</b>	<b>PHONE: 432-445-1472</b>	<b>FAX: 432-445-1474</b>	<b>24/7 CONTACTS</b>
William Tucker.....WilliamTucker@elliottelectric.com.....Operations Manager Bryson Walker.....BrysonWalker@elliottelectric.com.....Area Operations Manager Host Store: <b>Odessa, TX #066</b>	M-F: 7am-5:30pm Sat: 8am-Noon	166 Raul Florez Boulevard Pecos, TX 79772	William .....903-456-1387 Bryson .....325-260-7354	

<b>PLAINVIEW</b>	<b>#096</b>	<b>PHONE: 806-296-5518</b>	<b>FAX: 806-291-0839</b>	<b>24/7 CONTACTS</b>
Chris Courtney.....ChrisCourtney@elliottelectric.com.....Branch Manager Keagan McDermett.....KeaganMcDermett@elliottelectric.com.....Host Manager Host Store: <b>Lubbock, TX #110</b>	M-F: 7am-5:30pm Sat: Closed	2509 West 5th Street Plainview, TX 79072	Chris .....806-518-4970 Keagan .....806-831-1755	

<b>PLANO</b>	<b>#078</b>	<b>PHONE: 469-467-7771</b>	<b>FAX: 469-467-0282</b>	<b>24/7 CONTACTS</b>
Jenny Martin.....JenniferMartin@elliottelectric.com.....Branch Manager Robert Vaughan.....RobertVaughan@elliottelectric.com.....Operations Manager Host Store: <b>Dallas/Fort Worth (RDC), TX #034</b>	M-F: 7am-5:30pm Sat: 8am-Noon	2700 Summit Avenue, Suite 200 Plano, TX 75074	Jenny .....214-725-4983 Robert.....972-989-7806	

<b>PLEASANTON</b>	<b>#088</b>	<b>PHONE: 830-569-3390</b>	<b>FAX: 830-569-3608</b>	<b>24/7 CONTACTS</b>
Justin McCrary.....JustinMcCrary@elliottelectric.com.....Branch Manager Host Store: <b>San Antonio RDC, TX #073</b>	M-F: 7am-5:30pm Sat: 8am-Noon	2569 East Highway 97 Pleasanton, TX 78064	Justin .....210-882-2755	

<b>PROSPER</b>	<b>#TBD</b>	<b>PHONE: 469-899-3981</b>	<b>FAX: 469-899-3982</b>	<b>24/7 CONTACTS</b>	<b>OPENING SOON!</b>
Austin Fitzgerald.....AustinFitzgerald@elliottelectric.com.....Branch Manager Lisa McClure.....LisaMcClure@elliottelectric.com.....Operations Manager Host Store: <b>DFW (RDC), TX #034</b>	M-F: 7am-5:30pm Sat: 8am-Noon	700 Industry Way Suite 010 Prosper, TX 75078	Austin.....281-415-8757 Lisa .....940-297-9680		

<b>ROCKWALL</b>	<b>#077</b>	<b>PHONE: 469-913-1945</b>	<b>FAX: 469-913-1946</b>	<b>24/7 CONTACTS</b>	<b>NEW STORE!</b>
Lance Knight.....LanceKnight@elliottelectric.com.....Branch Manager Chris Harris.....ChristopherHarris@elliottelectric.com.....Operations Manager Host Store: <b>DFW (RDC), TX #034</b>	M-F: 7am-5:30pm Sat: 8am-Noon	1510 East Interstate 30 Rockwall, TX 75087	Lance.....972-333-8618 Chris .....469-396-7274		

<b>ROUND ROCK</b>	<b>#029</b>	<b>PHONE: 512-246-8001</b>	<b>FAX: 512-246-8002</b>	<b>24/7 CONTACTS</b>
Kody King.....KodyKing@elliottelectric.com.....Branch Manager Aaron McKee.....AaronMcKee@elliottelectric.com.....Operations Manager Host Store: <b>Austin (RDC), TX #064</b>	M-F: 6am-5:30pm Sat: 8am-Noon	445 Texas Avenue Round Rock, TX 78664	Kody .....512-567-2927 Aaron .....254-592-6788	

<b>SAN ANGELO</b>	<b>#063</b>	<b>PHONE: 325-944-7321</b>	<b>FAX: 325-944-1579</b>	<b>24/7 CONTACTS</b>
Brent Ogden.....BrentOgden@elliottelectric.com.....Branch Manager Bryson Walker.....BrysonWalker@elliottelectric.com.....Area Operations Manager Host Store: <b>Abilene, TX #058</b>	M-F: 7am-5:30pm Sat: Closed	3448 Sherwood Way San Angelo, TX 76901	Brent.....325-277-5487 Bryson .....325-260-7354	

<b>SAN ANTONIO (NORTH)</b>	<b>#129</b>	<b>PHONE: 210-646-6950</b>	<b>FAX: 210-826-1197</b>	<b>24/7 CONTACTS</b>
Danny Rodriguez.....DannyRodriguez@elliottelectric.com.....Branch Manager Host Store: <b>San Antonio RDC, TX #073</b>	M-F: 7am-5:30pm Sat: 8am-Noon	9707 Broadway Street San Antonio, TX 78217	Danny .....210-863-7997	

<b>SAN ANTONIO (RDC)</b>	<b>#073</b>	<b>PHONE: 210-646-6950</b>	<b>FAX: 210-646-6192</b>	<b>24/7 CONTACTS</b>
Brandon Hatch.....BrandonHatch@elliottelectric.com.....Operations Manager Chris Petty.....ChrisPetty@elliottelectric.com.....Regional Manager	M-F: 7am-5:30pm Sat: 8am-Noon	9707 Broadway Street San Antonio, TX 78217	Brandon .....210-204-9983 Chris .....512-789-2679	

<b>SAN ANTONIO (SOUTH)</b>	<b>#061</b>	<b>PHONE: 210-522-0146</b>	<b>FAX: 210-522-0732</b>	<b>24/7 CONTACTS</b>
Jason Pintirsch.....JasonPintirsch@elliottelectric.com.....Branch Manager Host Store: <b>San Antonio RDC, TX #073</b>	M-F: 7am-5:30pm Sat: 8am-Noon	5300 Bandera Road Leon Valley, TX 78238	Jason .....210-421-2804	

<b>SAN MARCOS</b>	<b>#098</b>	<b>PHONE: 512-392-4310</b>	<b>FAX: 512-392-4390</b>	<b>24/7 CONTACTS</b>
Adam Parker.....AdamParker@elliottelectric.com.....Branch Manager Host Store: <b>Austin (RDC), TX #064</b>	M-F: 7am-5:30pm Sat: 8am-Noon	1904 Dutton Drive San Marcos, TX 78666	Adam .....512-999-8383	

<b>SHERMAN</b>	<b>#097</b>	<b>PHONE: 903-892-8041</b>	<b>FAX: 903-892-8907</b>	<b>24/7 CONTACTS</b>
Jenny Martin.....JenniferMartin@elliottelectric.com.....Branch Manager Kenda Flowers.....KendaFlowers@elliottelectric.com.....Operations Manager Host Store: <b>Dallas/Fort Worth (RDC), TX #034</b>	M-F: 7am-5:30pm Sat: 8am-Noon	4509 Texoma Parkway Sherman, TX 75090	Jenny .....214-725-4983 Kenda .....903-357-3076	

<b>SPRING</b>	<b>#157</b>	<b>PHONE: 832-626-1994</b>	<b>FAX: 832-626-1995</b>	<b>24/7 CONTACTS</b>	<b>NEW STORE!</b>
Mike Baumann.....MikeBaumann@elliottelectric.com.....Branch Manager Host Store: <b>Houston (RDC), TX #049</b>	M-F: 7am-5:30pm Sat: 8am-Noon	21330 Inverness Forest Blvd. Houston, TX 77073	Mike .....281-851-2482		

References



## Store Information: Texas

## Texas (cont.)

<b>STAFFORD</b> #065 PHONE: 281-879-4911 FAX: 281-879-8596			<b>24/7 CONTACTS</b>
Jason Nevill ..... JasonNevill@elliottelectric.com ..... Branch Manager	M-F: 7am-5:30pm Sat: 8am-Noon	10650 West Airport, Suite 100 Stafford, TX 77477	Jason ..... 281-989-9322
Host Store: <b>Houston (RDC), TX #049</b>			
<b>STEPHENVILLE</b> #084 PHONE: 254-965-8083 FAX: 254-968-2662			<b>24/7 CONTACTS</b>
Ross Neel ..... RossNeel@elliottelectric.com ..... Branch Manager	M-F: 7am-5:30pm Sat: 8am-Noon	1035 South Graham Street Stephenville, TX 76401	Ross ..... 325-660-4658 Trae ..... 817-304-7620
Host Store: <b>Dallas/Fort Worth (RDC), TX #034</b>			
<b>SULPHUR SPRINGS</b> #004 PHONE: 903-885-0024 FAX: 903-885-0352			<b>24/7 CONTACTS</b>
Brian Monk ..... BrianMonk@elliottelectric.com ..... Branch Manager	M-F: 7am-5:30pm Sat: 8am-Noon	1220 Elm Street Sulphur Springs, TX 75482	Brian M. .... 903-348-3524 Brian S. .... 903-348-7300
Host Store: <b>Tyler, TX #002</b>			
<b>SWEETWATER</b> #093 PHONE: 325-236-6381 FAX: 325-236-6186			<b>24/7 CONTACTS</b>
David Smith ..... DavidSmith@elliottelectric.com ..... Branch Manager	M-F: 7am-5:30pm Sat: Closed	2311 East Broadway Street Sweetwater, TX 75556	David ..... 325-514-7348
Host Store: <b>Abilene, TX #058</b>			
<b>TEMPLE</b> #072 PHONE: 254-899-2800 FAX: 254-899-2805			<b>24/7 CONTACTS</b>
Kellen Ducey ..... KellenDucey@elliottelectric.com ..... Branch Manager	M-F: 7am-5:30pm Sat: 8am-Noon	2703 Hancock Drive Temple, TX 76504	Kellen ..... 254-458-2204
Host Store: <b>Austin (RDC), TX #064</b>			
<b>TERRELL</b> #026 PHONE: 972-563-2224 FAX: 972-563-2227			<b>24/7 CONTACTS</b>
Chad Oats ..... ChadOats@elliottelectric.com ..... Branch Manager	M-F: 7am-5:30pm Sat: 8am-Noon	1300 Highway 34 South Terrell, TX 75160	Chad ..... 214-908-7716 Ryan ..... 469-628-7985
Host Store: <b>Tyler, TX #002</b>			
<b>TEXARKANA</b> #030 PHONE: 903-223-6400 FAX: 903-223-6700			<b>24/7 CONTACTS</b>
Brad Lloyd ..... BradLloyd@elliottelectric.com ..... Host Manager	M-F: 7am-5:30pm Sat: 8am-Noon	800 Old Boston Road Texarkana, TX 75501	Brad ..... 870-904-5469 Kirk ..... 870-557-1955
Host Store: <b>Kirk Echols</b>			
<b>TOMBALL</b> #028 PHONE: 281-357-5300 FAX: 281-357-5005			<b>24/7 CONTACTS</b>
Mike Baumann ..... MikeBaumann@elliottelectric.com ..... Branch Manager	M-F: 7am-5:30pm Sat: 8am-Noon	201 South Persimmon Street Tomball, TX 77375	Mike ..... 281-851-2482
Host Store: <b>Houston (RDC), TX #049</b>			
<b>TYLER</b> #002 PHONE: 903-509-9882 FAX: 903-509-9832			<b>24/7 CONTACTS</b>
Jerry Camp ..... JerryCamp@elliottelectric.com ..... Area Manager	M-F: 7am-5:30pm Sat: 8am-Noon	3706 Frankston Highway Tyler, TX 75701	Jerry ..... 903-557-0963 Dean ..... 903-714-4203
Host Store: <b>Tyler, TX #002</b>			
<b>UVALDE</b> #103 PHONE: 830-278-1938 FAX: 830-278-1395			<b>24/7 CONTACTS</b>
Shane Davenport ..... ShaneDavenport@elliottelectric.com ..... Branch Manager	M-F: 7am-5:30pm Sat: 8am-Noon	17 Lou Stroup Drive Uvalde, TX 78801	Shane ..... 830-591-8555
Host Store: <b>San Antonio RDC, TX #073</b>			
<b>WACO</b> #042 PHONE: 254-752-3331 FAX: 254-752-3460			<b>24/7 CONTACTS</b>
Kellen Ducey ..... KellenDucey@elliottelectric.com ..... Branch Manager	M-F: 7am-5:30pm Sat: 8am-Noon	3325 Clay Avenue Waco, TX 76711	Kellen ..... 254-458-2204
Host Store: <b>Austin (RDC), TX #064</b>			
<b>WAXAHACHIE</b> #009 PHONE: 972-937-6965 FAX: 972-937-6968			<b>24/7 CONTACTS</b>
Allan Creamier ..... AllanCreamier@elliottelectric.com ..... Branch Manager	M-F: 6:30am-5pm Sat: 8am-Noon	706 Solon Road Waxahachie, TX 75165	Allan ..... 210-861-6377
Host Store: <b>Dallas/Fort Worth (RDC), TX #034</b>			
<b>WEATHERFORD</b> #052 PHONE: 817-599-7964 FAX: 817-599-8289			<b>24/7 CONTACTS</b>
Lee Robinson ..... LeeRobinson@elliottelectric.com ..... Branch Manager	M-F: 7am-5:30pm Sat: 8am-Noon	1830 Barnett Drive Weatherford, TX 76087	Lee ..... 817-597-0847
Host Store: <b>Dallas/Fort Worth (RDC), TX #034</b>			
<b>WICHITA FALLS</b> #113 PHONE: 940-257-6832 FAX: 940-257-6833			<b>24/7 CONTACTS</b>
James Sparks ..... JamesSparks@elliottelectric.com ..... Branch Manager	M-F: 7am-5:30pm Sat: 8am-Noon	903 Mississippi Avenue Wichita Falls, TX 76301	Chris ..... 940-631-5111
Host Store: <b>Dallas/Fort Worth (RDC), TX #034</b>			



## Product Index

A/C Disconnects .....	A10	Copper.....	D6
Acid Neutralizer and Test Kit (HVAC) .....	G8	THHN Feeder	
Additive Injection Tool (HVAC).....	G8	Romex® Non-Metallic	
Adjustable Bar Hangers.....	E25	UF Underground	
Adjustable Frequency Drives.....	H6	SEU Service Entrance	
Air Conditioners (HVAC).....	G3	Cord.....	D7
Air Handlers (HVAC).....	G4	SEO Portable Cord	
Air Registers (HVAC).....	G6	SPT Lamp Cord	
All-Thread Rod .....	E15	Thermostat	
Anchors .....	K33	Armored.....	D8
Angle Connectors .....	E15-E16	Hospital	
Arbors .....	K7	MC Cable	
Armored Cable .....	D8	Cable Connectors.....	D6, D8
Auger Bits.....	K6	Cable Cutters.....	K4, K12
Automatic Transfer Switches .....	A21	Cable Glands (Explosion Proof) .....	I9
Auxiliary Contacts.....	H4-H5, H7, H9	Cable Pullers .....	D4
Backpacks .....	K19	Cable Pulling Equipment .....	D4
Ballasts .....	C37	Cable Splicer's Kit .....	K13
Bar Hangers .....	E19	Cable Stripper/Cutter.....	K13
Bath Fans .....	C45	Cable Support.....	E23
Batteries .....	K20	Cable Ties.....	K30
Battery Chargers and Batteries (Milwaukee)....	K4	Caulk .....	K23
Battery Packs .....	C10, C16	Ceiling Fan Hangers.....	E23
Beam Clamps .....	E16, E19	Ceiling Heater.....	C46
Bell Boxes.....	E31, E33	Chase Nipples .....	E7
Bells.....	H26	Chico Sealing Compound.....	I5
Benders .....	K16	Chimes and Chime Kits .....	C45
Borescope .....	K11	Circuit Breaker Lockouts .....	K25
Box Connectors .....	D7	Circuit Breakers	
Boxes		Arc Fault/Ground Fault.....	A6
Cast Device Box Covers .....	I8	DIN Rail Mount .....	H24
Ceiling .....	E23-E25	Fault Sensing .....	A9
Square and Handy .....	E26-E28	Ground Fault .....	A6
Floor .....	E29	Load Center.....	A9
Residential.....	E30	Main Replacement .....	A10
Weatherproof.....	E31-E34	Molded Case .....	A16-A20
Breakers .....	(see Circuit Breakers)	Plug-In .....	A6
Bus Drop Grips .....	D7	Plug-On Neutral.....	A6, A9
Bushings.....	E6	Surge Protection.....	A7, A9
Butt Splices.....	K26, K28-K29	Circuit Tracer .....	K11
Buzzers.....	H26	Clampbacks.....	E4
Cable .....	D5-D8	Clamps .....	A14-A15, E16, E19-E20
Aluminum .....	D5	Cleaning Products for HVAC .....	G10
XHHW Feeder		Close Nipples .....	E7
URD Underground		Coil Replacement Starters.....	H4-H5, H9
Triplex Service Drop		Compact Blade Bases .....	H23
SEU Service Entrance		Compact Circuit Protectors.....	A28
		Compressor Terminal Repair Kits (HVAC).....	G8
		Concrete Anchors .....	K33



## Product Index

Concrete Generator Pads (HVAC) .....	G6	THHN .....	D5
Condensate Pumps (HVAC).....	G8	XHHW .....	D5
Condenser Fan Motors (HVAC).....	G8	Cord.....	D7
Condensers (HVAC).....	G3	Cord Connectors .....	D7
Conduit		Cords	
Aluminum Rigid .....	E5	120V Appliance .....	B7, B14
EMT .....	E3, E18	Dryer.....	B7, B14
Flexible Metal Conduit (Greenfield).....	E10	Patch.....	J6
Galvanized Rigid .....	E5	Range.....	B7, B14
Greenfield.....	E10	Couplings	
IMC Rigid.....	E5	Concrete-Tight.....	E4
Liquid-Tight.....	E11	EMT to Rigid.....	E7
Metallic .....	E11	Flexible Couplings .....	I4
Non-Metallic .....	E11	Rain-Tight.....	E4
PVC.....	E8	Rigid Steel.....	E17
Rigid .....	E5, E18	Rod.....	E15
Conduit Bender.....	K18	Set Screw .....	E3
Conduit Bodies .....	E18	Set Screw Rigid.....	E6
Conduit Clamps.....	E4	Three Piece.....	E5
Conduit Clips .....	E20	Cover Control Kits .....	H4
Conduit Hangers.....	E16	Crimping Tools.....	K13, K28-K29
Conduit Layout Tool.....	K18	Cubefuse Dual Element Time Delay.....	A28
Conduit Locknuts.....	E6	Cutting Oil.....	K18
Conduit Measuring Tape.....	K17	Data	
Conduit Outlet Bodies (Explosion Proof).....	I4	Enclosures.....	J3
Conduit Straps.....	E4-E5	Inserts - Jacks .....	J4
Conduit Supports.....	E20	Straps .....	J5
Conduit Union.....	E5	Tools .....	J5-J6
Condulets		Coax and Patch Panel.....	J6
Form 5 .....	E13	UPS and Servers.....	J7
Form 7 .....	E14	Wire and Cable.....	J8
PVC .....	E9	Dampers (HVAC).....	G11
Series 5 .....	E12	Dimmers .....	C39, C41-C42
Connectors		DIN Rail .....	H24-H25
Concrete-Tight.....	E4	Disconnects.....	K25
Liquid-Tight.....	E11	Door Switches .....	H26
Rain-Tight.....	E4	Downlight Housings.....	C6-C7
Set Screw .....	E3	Drain Gun (HVAC).....	G8
Set Screw Rigid.....	E6	Drain Pans (HVAC).....	G10
Straight Flex .....	E10	Drains for Non-Hazardous Locations .....	I8
Contact Blocks (Starter).....	H10, H13	Draw Studs .....	H10, K8
Contact Kits (Starter).....	H4	Drill Bits .....	K6
Contactors		Drill Bit Sets .....	K6
Accessories .....	H4, H9	Drill Kits .....	K4
Definite Purpose.....	H9	Drives (Variable Frequency).....	H6
HVAC.....	G9	Dryer Cords .....	B7, B14
Lighting.....	H9	Earthquake Clip.....	E19
Control Station Bodies.....	I5		
Copper Wire .....	D5		





## Product Index

Elbows		Flush Plates.....	B7, B14
90° Adjustable Sheet Metal (HVAC).....	G10	Foam Carriers.....	K17
Capped.....	I5	Furnace Blower Motors (HVAC).....	G8
Pull.....	E7	Furnaces (HVAC).....	G4
Rigid Steel.....	E17	Fuse Blocks.....	A24
Service Entrance.....	E7	Fuse Clips.....	H8
ELC Programmable Logic Controllers.....	H15	Fuse Holders.....	A24, A26
Electrical Coating.....	K24	Fuse Reducers.....	A22
Electrical Tape.....	K24	Fuses.....	A24-A28
Electrical Testers.....	K9	Electronic.....	A27
Electrical Troubleshooting Kit.....	K10	Fast Acting.....	A25-A27
Electronic Ballast Kits.....	C37	General Purpose.....	A24
Elliott Electric Supply Services.....	D3	Time Delay.....	A24-A28
EMT Conduit and Fittings.....	E4	Galvanized Rigid Conduit (GRC).....	E5
EMT Elbows.....	E3	Gangable Blocks.....	K27
Enclosures.....	F4, F7, H11, H13, I10, J3	Gasket Covers.....	E12
Home Network.....	J3	Gaskets.....	E12-E14
Oil-Tight Enclosures.....	H11, H13	General Duty Switches.....	A19
End Caps.....	E8	Generators.....	A23
End Plates.....	F5, F8	GFI Receptacles.....	B5, B12
ENT and Fittings.....	E10	Gloves.....	K20, K22
Ericson.....	E5	Glow in the Dark Tools.....	K12
Evaporator Coils (HVAC).....	G4	Glow Rod Sets.....	K17
Expansion Valves (HVAC).....	G4	Grommets.....	E23
Extension Cords.....	K21	Ground Clamps.....	A14
Fan Boxes.....	E23-E24	Ground Enhancement Material.....	A14
Fan Controls.....	C39	Grounding Bonding Intersystem.....	A14
Fan Units.....	C45	Grounding Clips.....	E24
Filter Bases (HVAC).....	G11	Grounding Plate.....	A14
Filters (HVAC).....	G5	Ground Rods.....	A14
Finger Saver Start Collars (HVAC).....	G11	Ground Screws.....	E24
Fire Alarm Stations.....	H26	Hammers.....	K16
Fire Barrier Sealant and Firecaulk.....	K23	Hand Bender.....	K18
Fishing Line.....	K17	Handy Boxes.....	E27
Fish Tape.....	K17	Hanger Straps (HVAC).....	G11
Fittings.....	B17-B20, E5, E10, E19	Hard Hats.....	K22
Fixture Hangers.....	E26	Hard Start Kits (HVAC).....	G8
Fixture Support.....	E19	Heater Elements (HVAC).....	G4
Flange Clips.....	E19	Heater Packs.....	H3
Flashlights.....	K20	Heaters.....	C46, H3
Flex Connectors.....	E10	Heat Pumps (HVAC).....	G3, G12
Flex Duct (HVAC).....	G6	Heat Shrink Tubing.....	K25
Flex Fittings.....	E10	Heavy Duty Lockout Tags.....	K25
Flexible Metal Conduit.....	E10	Heavy Duty Switches.....	A21
Flex Splitter.....	E10	Hex Key Set.....	K15
Floodlight Kits.....	C19	High Bays.....	C16
Floor Boxes.....	E29	HMI Operator Interface.....	H15
Fluorescent Tube Guards.....	C21		



## Product Index

Hole Saw Kit.....	K7	Kellum's Grip .....	D7
Horns.....	H26	Keystone Connectors (Data).....	J4
Housings - Recessed Lighting.....	C6, C7	Keystone Inserts (Data).....	J4
Hubs.....	A9, A12-A13, A19, C40, E5, E17	Knife Blade Fuse.....	A24
Hurricane Clip.....	E19	Knives.....	K13-K14
HVAC.....	G3-G12	Knock-Out Adaptors .....	K8
Acid Neutralizer and Test Kit.....	G8	Knock Out Bushings.....	D6
Additive Injection Tool.....	G8	Knockout Closures .....	E7
Air Conditioners.....	G3	Knock-Out Dies.....	K8
Air Handlers.....	G4	Knock-Out Punch and Die Sets.....	K8, K16
Air Registers.....	G6	Knock-Out Punches.....	K8
Dampers.....	G11	Knockout Punch Tool.....	H10
Drain Gun.....	G8	Knockout Seals.....	E7
Drain Pans.....	G10	Knockout Tool.....	K4
Elbows (90° Adjustable Sheet Metal).....	G10	Label Printers .....	K34
Evaporator Coils.....	G4	Ladders.....	E9, K21
Expansion Valves.....	G4	Lamp Covers.....	E31, E33
Filter Bases.....	G11	Lamp Guards.....	C21
Filters.....	G5	Lampholders.....	E31, E33
Finger Saver Start Collars.....	G11	Lamps - LED	
Flex Duct.....	G6	A-Line.....	C20, C22, C28, C35
Furnace Blower Motors.....	G8	Decorative.....	C20, C23, C35
Furnaces.....	G4	Dimmable.....	C24, C28-C29
Hanger Straps.....	G11	Directional.....	C20, C24, C35
Hard Start Kits.....	G8	PAR.....	C20, C22, C24, C28, C35, C38
Heater Elements.....	G4	Reflector.....	C20, C22, C35, C38
Heat Pumps.....	G3, G12	Replacement Lamps.....	C23, C33-C34, C38
Hoses.....	G9	Replacement Tubes.....	C22, C28
Motor Run Capacitors.....	G7	Sign Tubes.....	C33
Plastic Pads.....	G6	Vintage Style.....	C24, C29, C38
Plenums.....	G10	Lamp Sockets.....	C21
Refrigerant.....	G5	Lamps - Traditional	
Regulators.....	G9	A-Line.....	C25
Replacement Gauges.....	G9	Biax.....	C27, C32
Replacement O-Rings.....	G8	High Pressure Sodium.....	C27, C32
Rex Racks.....	G10	Linear Fluorescent.....	C26, C31
Uncrimped Reducers.....	G11	Metal Halide.....	C32
IMC Rigid Conduit and Fittings.....	E5	PAR.....	C25, C31
Indicating Lights.....	H10, H12-H13	Quartz.....	C25
Infrared Heaters.....	C46	Reflector.....	C25, C31
Infrared Scanners.....	K9	Lay-In and Troffer Support Clip.....	E19
Inline Fuse Holders.....	A25-A26	Leak Repair (HVAC).....	G9
Inserts - Home Network (Data).....	J4	LED Disk Light.....	C5
Jack Chain.....	K31	LED Downlight.....	C5
Jelly Jar Fixtures.....	C14, C19	LED Flat Panels.....	C4
Jiffy Clips.....	E4, E5	LED Retrofit Adjustable Gimbals.....	C5
Junction Boxes.....	F3, F6, I4	LED Tape Lights and Accessories.....	C36
		Builder Channels.....	C36



## Product Index

Channel Covers.....	C36	Lube - Pulling.....	K17
Channel End Caps.....	C36	Lubricants - Thread.....	I5
Light Connectors.....	C36	Lugs.....	A12, K26, K28
Legend Plates.....	H11, H13	Manual Transfer Switches.....	A21
Levels.....	K16	Marker.....	K8
Lighting - LED		Masonry Anchors.....	K33
Area Lights.....	C9, C15, C17	Mastic Pads.....	K24
Canopy Lights.....	C15	MC Cable.....	D8
Compact Floodlights.....	C19	Mechanical Interlock Kit.....	H4, H9
Disk Light.....	C5	Megger.....	K10
Downlights.....	C5, C14	Mesh Grips.....	D7
Emergency/Exit Lighting.....	C10, C14	Metal Stud Clip.....	E20
Flat Panels.....	C4, C12	Meters.....	K9-K11
Flood Lights.....	C8-C9, C15, C17, C19	Meter Sockets.....	A12-A13
Garage Lights.....	C18	Minerallac.....	E16
High Bays.....	C8, C13, C18	Mini-Split Cable (HVAC).....	G12
Lay-Ins.....	C4, C12	Mini-Split Systems (HVAC).....	G12
Shoplights.....	C10, C13	Molded Case Circuit Breakers.....	A17-A20
Spotlights.....	C19	Molds - Thermal Connections.....	A15
Strip Lights.....	C4, C12	Motor Run Capacitors (HVAC).....	G7
Undercabinet Lights.....	C10, C14	Mounting Brackets (Box).....	E22-E23
Vapor Proof.....	C14, C19	Mud Ring (Box).....	E24
Wall Packs.....	C8, C15, C18	Multimeters.....	K9-K11
Washdowns.....	C18	Myer's Hubs.....	E5, E17
Wet Location.....	C13		
Wrap Arouds.....	C4, C12, C19	Nail Plate.....	D6
Lighting - LED Accessories		Neutral Kits.....	A21
Emergency Battery Packs.....	C10	Nipples.....	E7
Fixture Hooks.....	C8	No-Dog Offset Level.....	K16
Mounting Posts.....	C19	Non-Metallic Sheathed Cable.....	D6
Non-Shunted Tombstone Harnesses.....	C33	Nut Drivers.....	K5, K14-K15
Poles.....	C17		
Retrofit Adjustable Gimbals.....	C5	Oil-Tight Pushbutton Hole Seals.....	F4, F7
Sensors.....	C19	Outlets.....	B3, B6-B7, B11-B14
Surface Mounts.....	C5	Outlet Straps (Data).....	J5
Tube Strip Fixtures.....	C33	Overload Relays.....	H4-H5
Lighting - LED for Hazardous Locations.....	I7	Oxide Inhibiting Compound.....	K26
Lighting Showroom.....	C3		
Lighting - Traditional.....	C11, C16	Panelboards.....	A16
Light Receptacles.....	C21	Panels.....	A23
Light Units.....	H13	Generator.....	A23
Limit Switches.....	H14	Manual Transfer.....	A23
Liquid Tight Conduit.....	E11	Patch Panels (Data).....	J6
Load Centers.....	A4-A5, A7-A8	Phase/Motor Rotation Tester.....	K11
Accessories.....	A6, A9	Phone Holders.....	K19
Combination.....	A8	Photocontrols.....	C43
Main Breaker.....	A4, A8	Pilot Bits.....	K7
Main Lug.....	A5, A8	Pin and Sleeve Devices.....	I6
Locknuts.....	E6	Pipe Straps.....	E15-E16



## Product Index

Pipe Support.....	E21	GFI .....	B5, B12
Plaster Rings .....	E26, E28	Hospital Grade .....	B12
Plasti-Bond .....	E17	Pin & Sleeve.....	I6
Plastic Pads (HVAC).....	G6	Range.....	B7, B14
Plenums (HVAC) .....	G10	Residential Grade.....	B5, B12
Plier Handles .....	K12	RF.....	C40
Pliers.....	K12, K15	USB Charging .....	B4, B12
Plugs.....	B6, B13, I6	Receptacle Testers .....	K11
Poly Pull Tape.....	K17	Recessed Floor Box Cover Kits.....	E29
Portable Cord .....	D7	Recessed Housings.....	C6-C7
Power Blocks.....	H19	Recessed Trims.....	C6
Power Cord Caps .....	B7, B14	Reducing Washers .....	E7
Power Defense Circuit Breakers .....	A19-A20	Refrigerant (HVAC).....	G5
Power Outlet Devices .....	B7, B14	Regulators (HVAC).....	G9
Power Poles .....	H9	Relays.....	H15, H20-H23
Power Supplies.....	H20	Alternating Relays .....	H21
Pressure Switch.....	A11	EZ Series Intelligent Relays .....	H15
Primary Fuse Kit.....	A22	General Purpose Plug-In Relays.....	H22
Pro Amplifier Tone Generator Kit.....	J5	Latching Relays.....	H22-H23
Programmable LED Drivers.....	C37	Mounting Sockets.....	H22
Programmable Logic Controllers .....	H15	Operate Delay Relays .....	H21
Pull Boxes.....	F5, F8	Timing Relays.....	H20
Pull Elbows .....	E7	Replacement Gauges (HVAC).....	G9
Pump Panels .....	H8	Replacement O-Rings (HVAC).....	G8
Punch Down Tool.....	J5-J6	Reversing Drum Switch .....	H4
Pushbuttons.....	H10-H13, H26	Rex Racks (HVAC).....	G11
IEC.....	H12-H13	Rigid Bender.....	K18
NEMA .....	H10-H11	Rigid Conduit.....	E5
Push-In Wire Connectors .....	K25	Ring Covers.....	E26
PVC .....	E8-E9, K18	Rod Operators.....	H14
Cement and Primer .....	E8, K18	Rod Securing Clip.....	E21
Conduit.....	E8	Romex .....	D6
Cutters.....	E9	Roof Flashings.....	A14
Elbows.....	E8	Safety Glasses .....	K22
End Caps.....	E8	Safety Vests.....	K22
Fittings and Connectors .....	E8	Saw Blades.....	K7
"FS" Boxes and Junction Boxes.....	E9	Saws	
Pipe Straps.....	E9	Bi-Metal Hole Saws .....	K7
Reducers .....	E8	Hacksaw.....	K16
UL End Bells.....	E9	Reciprocating Saws.....	K3
Weatherheads .....	E9	Sub Compact Band Saws .....	K3
Raceway Wiremold.....	B17-B20	Sawzall .....	K3
Rags .....	K23	Scissors .....	K13
Range Receptacles .....	B7, B14	Screw Clamp Ground Blocks.....	H25
Rapid Punch Tool (Data) .....	J6	Screwdriver Bits.....	K5
Receptacle Plates.....	B16	Screwdriver/Nutdriver .....	K15
Receptacles		Screwdrivers.....	K14-K15
Commercial Grade .....	B5, B12	Screw Gun Brackets.....	E22
Dryer.....	B7, B14		



## Product Index

Screw Kits.....	K31	Switch Bodies.....	H14
Screws.....	E24, K31-K32	Switch Boxes.....	E25
Green Ground Screws.....	E24	Switches - Power	
Wall Plate.....	B10, B16	General Duty.....	A20
Sealant.....	K24	Heavy Duty.....	A20
Sealing Compounds.....	I5	Manual Transfer.....	A20
Seals.....	E7	Switches - Wall.....	B3-B4, B11, C45
Sealtite.....	E11	Switch Plates.....	B9, B15
Selector Switches.....	H10, H13	Tape.....	K24-K25
Sensor Heads.....	H19	Tape Measures.....	K16
Sensors - Industrial Control.....	H16-H19	Tapping Tools.....	K14
Barrel.....	H19	Tele-Power Poles.....	B20
Inductive Proximity.....	H16-H17	Temporary Lighting String.....	C21
Service Entrance Hardware.....	A14	Temporary Power Centers.....	B6
Service Panels.....	A10, A11	Terminal Blocks.....	H24-H25
Mobile Home.....	A10	Terminals - Wire.....	K27-K29
RV Park.....	A11	Thermostats.....	G5
Temporary Power.....	A11	Thermostat Wire.....	D7
Sheetrock Clamps.....	E24	Thinwall Conduit.....	E3
S Hook.....	K31	Threadless Compression Couplings.....	E5
Shovels.....	K21	Tie Wire.....	K31
SIMPull CoilPAK Payoff.....	D4	Time Clocks.....	C44
SIMPull Flange.....	D4	Time Delay Fuses.....	A24-A26
Smart Home Technology.....	C42	Timers.....	C44
Smoke/CO Alarms.....	C46	Toggle Bolts.....	K31
Smurf.....	E10	Toggle Kits.....	K33
Snap On Rails.....	G11	Toggle Switches.....	C21
Soap.....	K17	Tool Kits.....	K3, K35
Socket Adapters and Extender Lights.....	C21	Tools - Hand	
Socket Adaptor Tool.....	K5	Bags.....	K19
Soldering Equipment (HVAC).....	G9	Boxes.....	K36
Spacers - Underground Duct.....	E9	Cable Cutters.....	K12
Splice Kits.....	K24	Crimpers.....	K13, K28-K29
Split-Bolt Connectors.....	K26	Hammers.....	K16
Splitters (Data).....	J6	Hex Keys.....	K15
Spray Paint.....	K18	Knockout Punch Set.....	K16
Spring Channel Nuts.....	E15-E16	Levels.....	K16
Spring Connectors.....	K25	Nut Drivers.....	K15
Spring Nuts.....	E15	Pliers.....	K12-K13
Stakon Tool.....	K29	Pump Pliers.....	K15
Standard Octal Relay Bases.....	H23	Screwdrivers.....	K14-K15
Staples - Wire.....	D6	Tape Measures.....	K16
Starters.....	H3, H6-H7	Tapping Tools.....	K14
Sticky Backs - Ty Rap.....	K30	Wire Strippers/Cutters.....	K13
Strain Relief Connectors.....	D7	Wrenches.....	K14
Straps - Conduit.....	E5, E20	Tools - Power.....	K3-K4, K35
Surface Radiant Heater.....	C46	Band Saw.....	K3
Surface Raceway.....	B17-B20	Batteries and Charger.....	K4
Surge Protection Devices.....	A7		



## Product Index

Cable Cutters .....	K4	Wire Nuts .....	K25
Crimper .....	K35	Wire Pulling Compound .....	K17
Hammer Drill/Driver .....	K3	Wire Reel Stand .....	D4
Hex Impact Driver .....	K3	Wire Strippers/Cutters .....	K13
Knockout Tool .....	K4	Wireways .....	F5, F8
Pipe Threader .....	K35	Wrenches .....	K14
Right Angle Drill .....	K4		
Rotary Hammer .....	K35	Zip Ties .....	K30
Sawzall Reciprocating Saws .....	K3	Z Purlin Clips .....	E19
Transformers .....	A22, H26		
Transformer Vibration Isolation Pads .....	A20		
Trims .....	C5-C7		
Twin Breakers .....	A6		
Twirl Channel Nuts .....	E15-E16		
Twist On Fixture Support .....	E19		
TY-RAPS .....	K30		
Uncrimped Reducers .....	G11		
Underground Duct Spacers .....	E9		
Uninterruptable Power Supplies .....	J7		
Unions .....	E17, I4		
Universal Drain/Breather .....	I5		
URD .....	D5-D6		
Utility Boxes .....	E27		
Vacuum Contactors .....	H8		
Vinyl Ducting .....	C46		
Vinyl Tape .....	K24		
Voice and Video Module .....	J4		
Voltage Detectors .....	K9-K10		
Voltage Monitors .....	H21		
Voltage Testers .....	K11		
Wall Plates .....	B8-B10, B15, J4-J6		
Blank .....	B10		
Decorator .....	B8, B10, J5		
Home Network .....	J4		
Screwless .....	B8, B15		
Washers .....	E7, K31		
Weatherhead Entrance Caps .....	A14		
Weathershield Kits .....	A22		
Wedge Clamps .....	A14		
Wedge-Nut Covers .....	E14		
Welding/Cutting Accessories .....	G9		
Welding/Cutting Torch .....	G9		
Window Shades - Lutron .....	C41		
Wire .....	D7		
Wireless Sensor Products .....	C40-C42		
Wire Marking .....	K30		
Wire Mold .....	B17-B20		



## Manufacturers Index

<b>3M</b> ..... K22-K25, K30	<b>Diversitech Corporation</b> ..... G6, G11-G12
	<b>Morris Products Inc.</b> .....A20, G8
<b>ABB Installation Products</b>	<b>Eaton</b>
<b>Thomas &amp; Betts</b> .....A12, A14, D6-D7,	<b>B-Line</b> .....E16, E19-E23,F3-F5
.....E11, E15, E24-E30, K26, K28-K30	<b>Bussmann</b> .....A22, A24, A26
<b>Ace Chemical &amp; Equipment</b> ..... G9-G10	<b>Corp</b> .....A4-A12, A16-A21, A27, C21,
<b>Acuity Brands</b>	..... H3-H15, H17-H18, H20, H22, H24-H25
<b>Lithonia Lighting</b> ..... C12-C16	<b>Crouse-Hinds</b> ..... D7, E3-E6, E11-E14,
<b>Advance by Signify</b> ..... C37	..... E24-E28, I4-I10
<b>Allied Molded Products</b> ..... E30	<b>Edison</b> .....A22-A23, A25
<b>Appleton</b> (see <b>Emerson</b> )	<b>Power Quality</b> ..... A7, J7
<b>Arlington Industries</b> .... D6, D8, E22-E24, E29	<b>Wiring Devices</b> ..... B3-B10, C21
<b>Atco Rubber Products</b> ..... G6	<b>ECN/Korns</b> (see <b>Robroy Industries</b> )
<b>Atkore International</b>	<b>Edwards Signaling</b> ..... H26
<b>Calbrite</b> ..... E18	<b>Emerson</b>
<b>Heritage Plastics</b> ..... E8	<b>Appleton</b> .....I6
<b>Banner Engineering</b> ..... H19	<b>Engineered Products</b> ..... C21
<b>Brady Worldwide, Inc.</b> ..... K34	<b>Erico</b>
<b>Bridgeport Fittings</b> ..... A14, D6, D8	<b>Caddy</b> .....E19-E23
.....E3-E7, E10-E11, E16	<b>Cadweld</b> .....A14-A15
<b>BRK Brands/First Alert</b> ..... C46	<b>Fluke Electronics</b> .....K9-K10
<b>Broan/Nutone LLC</b> ..... C45-C46	<b>GE by Current</b> ..... C22-C27
<b>Burton Wire and Cable</b> ..... G12	<b>Generac Power Systems</b> ..... A21
<b>Calbrite</b> (see <b>Atkore International</b> )	<b>Global, The Source</b> ..... G7, G9
<b>Cantex</b> .....A14, E8-E9, E30	<b>Greenlee Textron</b> ..... H10
<b>Clarcor Air Filtration</b> ..... G5	<b>Gunder Associates, Inc.</b> ..... G6
<b>Cody Company, LLC</b> ..... G10-G11	<b>Harris Products Group</b> ..... G9
<b>Cooper Lighting Solutions</b> .....C4-C11	<b>Heritage Plastics</b> (see <b>Atkore</b> )
<b>CPS Products</b> ..... G8	<b>Hoffman Enclosures, Inc.</b> (see <b>Nvent</b> )
<b>CRC Industries, Inc.</b> ..... K18	<b>Hubbell</b>
<b>Deflecto Corporation</b> ..... C46	<b>Killark</b> .....I6
<b>Diode LED</b> ..... C36	<b>Taymac</b> .....E31-E32
	<b>Hudson Technologies Co.</b> ..... G5

References



## Manufacturers Index

<b>Ideal Industries</b> .....	E10, J5, K11, K17, ..... K23, K25	<b>Precision Electric Motor</b> .....	G8
<b>IDEC Corporation</b> .....	H23	<b>PRO1 IAQ Inc.</b> .....	G5
<b>Keystone Technologies</b> .....	C33-C35	<b>RAB Lighting</b> .....	C17-C20
<b>Killark</b> (see <a href="#">Hubbell</a> )		<b>Rayovac Corporation</b> .....	K20
<b>King Wire Inc.</b> .....	D5	<b>Rectorseal</b> .....	E8, K18, K23
<b>Klein Tools</b> .....	J5, K11-K20, K25, K29	<b>Republic Conduit</b> (see <a href="#">Nucor Tubular Products</a> )	
<b>L.H. Dottie</b> .....	D4, D6, E9, E15, E21, E24, ..... K17, K21, K23-K24, K31-K33	<b>Robert Shaw Climate</b> .....	G5
<b>LCOMP</b> .....	C21	<b>Robroy Industries</b>	
<b>Ledvance</b>		<b>ECN/Korns</b> .....	E3, E5, E7, E16
<b>Sylvania</b> .....	C28-C32	<b>Plasti-Bond</b> .....	E17
<b>Legrand</b>		<b>Satco</b> .....	C38
<b>Pass &amp; Seymour</b> .....	B11-B16, C21, D7, ..... E23, E33-E34, J3-J5	<b>Southwire</b> .....	B7, B14, C21, D4-D8 ..... E10-E11, J8, K21
<b>Wiremold</b> .....	B17-B20	<b>Maxis</b> .....	D4, K18
<b>Lithonia Lighting</b> (see <a href="#">Acuity Brands</a> )		<b>Steren Electronics Int.</b> .....	J6
<b>Louisville Ladder</b> .....	K21	<b>Superflex Ltd.</b> .....	E11
<b>Lutron</b> .....	C39-C42	<b>Sylvania</b> (see <a href="#">Ledvance</a> )	
<b>Mainstream Engineering</b> .....	G8	<b>Taymac</b> (see <a href="#">Hubbell</a> )	
<b>Mars</b> .....	G7	<b>Texas Gasket &amp; Packing</b> .....	E12-E14
<b>Milbank Manufacturing</b> .....	A13	<b>Thomas &amp; Betts</b> (see <a href="#">ABB Installation Products</a> )	
<b>Milwaukee Tool</b> .....	K3-K8, K25, K35-K36	<b>Time Mark Corporation</b> .....	H21
<b>North American VRF LLC</b> .....	G12	<b>Weidmüller, Inc.</b> .....	H24
<b>NSi Industries</b> .....	A14, K27	<b>Wiremold</b> (see <a href="#">Legrand</a> )	
<b>Tork</b> .....	C43-C44	<b>Wirexpress</b> .....	J6, J8
<b>Nucor Tubular Products</b> .....	E3, E5	<b>York International/JCI</b> .....	G3-G4
<b>Nvent</b>			
<b>Hoffman Enclosures, Inc.</b> .....	F6-F8		
<b>Pass &amp; Seymour</b> (see <a href="#">Legrand</a> )			
<b>Plasti-Bond</b> (see <a href="#">Robroy Industries</a> )			