



Moto Snap

by myGEKOgear

User Manual

Thank you for purchasing the myGEKOGear Moto Snap. This product is specifically designed to record real time video when riding a scooter or motorcycle.

The content in this document is for informational purposes only and is subject to change without prior notice. We have made every effort to ensure that this User Guide is accurate and complete, however, no liability is assumed for any errors or omissions.

The manufacturer reserves the right to change the technical specifications or accessories without prior notice.

Notice

1. Please peel off the protective film from the camera lens before use.
2. Do not touch the lens with your fingers. Finger grease may be left on the lens, resulting in unclear videos or pictures. Inspect and clean the lens with a soft, non-abrasive cloth regularly.
3. Please charge the unit to full before first use using the provided Type-C cable or optional charge station. Please do not use another brand of charging cable to avoid a potential equipment malfunction. The red LED on the camera will illuminate when charging, and will turn off upon reaching full charge.
4. If the Moto Snap will not be used for an extended period of time, please charge at least once every 6 months to maintain the battery's health and avoid low-voltage related damage.
5. Please download the Moto Snap app from the iOS app store or Google Play Store before use. The Wi-Fi password is **12345678**.
6. By default, Wi-Fi is ON for 3 minutes when the camera is powered on. If it does not connect to the Moto Snap app within 3 minutes, the

Moto Snap will disable Wi-Fi automatically to save power. To turn on Wi-Fi again, simply power the Moto Snap OFF then ON again.

NOTE: An active Wi-Fi connection will affect total recording time.

7. Ensure the microSD card is V30 or higher, with a capacity of 16GB or higher (up to 128GB).
 8. Format your microSD card regularly and synchronize date/time. (Recommended: Once per month)
 9. **In a high humidity environment or when traveling between areas with a large temperature difference, light moisture or fog, may appear on the lens. This is normal. If this happens, remove the microSD card and allow several hours for the moisture to evaporate, then reinsert the card and resume use.**
 10. Due to local laws and for your own safety, DO NOT operate the Moto Snap or Moto Snap app while driving or riding.
 11. Use the Moto Snap app to synchronize your date and time before first use.
 12. This product is intended only for non-commercial use, within the maximum limits permitted by law. We take no responsibility for any losses as a result of use of this product.
 13. The camera may get warm during use. This is normal.
 14. Improper use or operation of the Moto Snap may result in damage to the camera or its accessories and will void the warranty.
-

This device and its antenna(s) must not be co-located or operated in conjunction with any other antenna or transmitter.

FCC Regulatory Compliance

This device complies with Part 15 of the FCC Rules. Operation is subject to the following two conditions: (1) this device may not cause harmful interference, and (2) this device must accept any interference received, including interference that may cause undesired operation.

Note: This equipment has been tested and found to comply with the limits for a Class B digital device, pursuant to Part 15 of the FCC Rules. These limits are designed to provide reasonable protection against harmful interference in a residential installation. This equipment generates, uses and can radiate radio frequency energy and, if not installed and used in accordance with the instructions, may cause harmful interference to radio communications. However, there is no guarantee that interference will not occur in a particular installation.

If this equipment does cause harmful interference to radio or television reception, which can be determined by turning the equipment off and on, the user is encouraged to try to correct the interference by one or more of the following measures:

- Reorient or relocate the receiving antenna.
- Increase the separation between the equipment and receiver.
- Connect the equipment into an outlet on a circuit different from that to which the receiver is connected.
- Consult the dealer or an experienced radio/TV technician for help.

Warning: changes or modifications not expressly approved by the party responsible for compliance could void the user's authority to operate the equipment.

To maintain compliance with FCC's RF Exposure guidelines, This equipment should be installed and operated with minimum distance between 20cm the radiator your body: Use only the supplied antenna.

Contains FCC ID: please refer to website www.mygekogear.com

RF Exposure Compliance

This equipment complies with FCC radiation exposure limits set forth for an uncontrolled environment. This equipment should be installed and operated with minimum distance 20cm between the radiator and your body. This transmitter must not be co-located or operating in conjunction with any other antenna or transmitter.

Regulatory Notice

- ❖ This document provides country- and region-specific non-wireless and wireless regulatory notices and compliance information for your product. Some of these notices may not apply to your product.
- ❖ Disposal of a battery into fire or a hot oven, or mechanically crushing or cutting of a battery can result in an explosion.
- ❖ Leaving a battery in an extremely high temperature environment can result in an explosion or the leakage of flammable liquid or gas.
- ❖ Wi-Fi Signals are unable to pass through buildings. The signal transmission limit is 5m.
- ❖ Wi-Fi Operation Channel: Ch1~Ch11
- ❖ The product employs wireless data communication which may interfere or be interfered by a nearby camcorder.
- ❖ Do not use this camcorder in the vicinity of a microwave oven or where there is radio interference.
- ❖ Radio wave reception may be worsened in certain environments.
- ❖ Please be advised that if another camcorder is also using the same 2.4GHz band as this product, the processing speed of both camcorders may slow down.
- ❖ The radio frequency (RF) generated by this RF electronic camcorder may cause adverse effects on the operation of other electronic camcorders and result in malfunctioning. Wireless transmitters and circuitry may also interfere with other electronic camcorders.

Therefore, do observe the following precautions:







Aircraft: Never use a radio transmitter when you are in an airplane. Please switch off the Wi-Fi function of the camcorder.

- Vehicle: The radio frequency transmitted by this camcorder may affect the electronic system in a motorized vehicle. Please consult your vehicle manufacturer on possible effects.
 - Pacemaker: In order to prevent any potential interference to a pacemaker, anyone who uses a pacemaker should be advised that, when using this camcorder, a minimum distance of 15cm (6 inches) should be kept between the camcorder and the pacemaker; and never put this camcorder in a chest pocket. In case of any doubt of interference, switch off the camcorder immediately.
 - Medical Camcorder: If you use a personal medical camcorder, consult the camcorder manufacturer or your physician to confirm if your camcorder is sufficiently shielded from the RF transmission of this camcorder.
 - Medical Facilities: Hospitals and medical institutes may use facilities that are sensitive to an external RF signals. Observe such instructions when the medical care personnel or any posted sign requests you to switch off any camcorder that may interfere the radio frequency.
 - Explosion sites or any location with a posted sign: In order to prevent interfering with an explosion activity, observe all the signage and instructions in the Explosion Area or in a zone with a “Switch Off 2-way Radios” sign by switching off camcorders that may interfere with the radio frequency.
- ❖ myGEKOGear is NOT responsible for the loss of any data/content during operation.

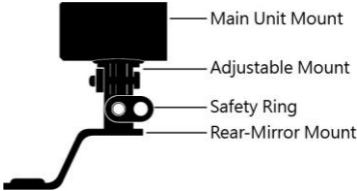
By using the myGEKOGear Moto Snap, it is assumed that you agree to all of the above statements.

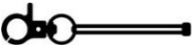
Step 1: Check What's Inside

The package contains the following items. If any items are missing or damaged, please contact the original place of purchase immediately.

Main Camera	3-in-1 Mount – Mirror + Snap Mount		
			
Hex Wrench			
			
Safety Cord	USB Cable (type C)	Helmet Mount	User Manual & Warranty
			

Step 2: Product Overview

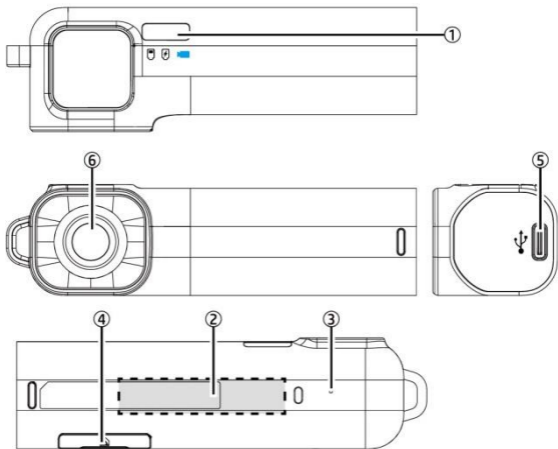

No	Description	No	Description
1	LED indicator	4	microSD slot / Reset
2	Power ON/OFF sensor	5	USB port (type C)
3	Microphone	6	Lens

Step 3: Insert microSD Card

Insert the microSD memory card with the pins facing forward and the Moto Snap lens facing forward. (See below for proper installation orientation.) Once the memory card locks into place, replace the slot cover securely over the slot.



The slot cover must be tightly sealed to prevent moisture from entering, causing the lens to fog. Insert the lower edge of the slot cover, then press the top edge and sides of the slot cover to create a good seal. See below.

(1)



(2)



(3)





(4)

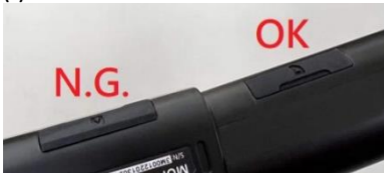

(5)



Step 4: LED Indicator

Indicator	Light Status	Description
 Recording	Blue, slow flashing	Recording
	Blue, solid	Camera ON, not recording
	Blue, rapid flashing	Emergency recording
 Charging, Plugged in	Red, solid	Charging
	No Red Light	Fully charged
 Battery	Green, rapid flashing	Low battery

Note: Before first use, use the supplied USB Type-C charging cable to fully charge the Moto Snap. Charge for at least 5 hours until the red LED turns off.

Step 5: Download the App

When using the Moto Snap for the first time, use your smartphone to download and install the **Moto Snap** app. Scan the QR code or search “Moto Snap” in the iOS App Store or Google Play Store.



iOS



Android

APP layout and features may be changed subject to different software versions. Please refer to the Google Play or iOS App Store for the latest version.

Step 6: Wi-Fi Connection

1 When secured into the Snap Mount, the Moto Snap and its Wi-Fi will automatically power on. Using your smartphone, search nearby Wi-Fi networks for **MOTO_SNAP** and tap to connect. Enter password **12345678** to connect to and control the Moto Snap.



2 Once Wi-Fi is connected, open the Moto Snap app to connect to and control your camera and its settings. For detailed app operation, please refer to: **[Step 10. App Operation]**

Note:

1. Wi-Fi is turned on automatically when the Moto Snap powers on. If the camera doesn't connect with the Moto Snap app within 3 minutes, Wi-Fi will be disabled automatically to preserve battery life. If you want to turn on Wi-Fi once again, simply unplug the Moto Snap from the mount, wait for all indicator lights to turn off, and plug it in once again to power on the camera and reactivate the Wi-Fi.
2. Your smartphone must be within a maximum 5-meter distance from the Moto Snap with no buildings in between.
3. The language of the app will be consistent with your smartphone. Beyond the language options, the app will be activated with the default language.

Step 7: Main Unit Installation

The Moto Snap can be installed on the right or left rearview mirror. Please use the mirror mount and snap mount to adjust and fine tune the installation position of the camera. See below for an example of a left side installation.

- 1 Unbolt the rearview mirror and install the 3-in-1 mount as seen below.



- 2 Reinstall the mirror and 3-in-1 mount onto the handlebar.



Note: Regardless of whether the camera is installed on the left or right side, the myGEKOGear logo on the snap mount must always be upright and face out, with the LED indicator lights always facing up. Below are installation examples for reference.



Right side (inner) installation.



Left side installation.



Right side (outer) installation.

- 3 Slip the safety cord into the safety cord hole of the main unit.



- 4 Plug the Moto Snap into the Snap Mount and push it to the bottom until it snaps into place. The blue LED light will blink slowly to indicate that the camera is now recording. If recording does not begin, check that the microSD card is inserted properly.



- 5 Make sure your phone is connected via Wi-Fi to MotoSnap



and open the Moto Snap app

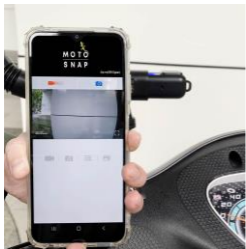

- 6** Fasten the safety cord from the main unit to the safety ring on the mount to protect your camera from accidentally falling out of the mount while riding.



Step 8: Main Unit Calibration and Use

After adjusting your viewing angle, tap  in the Moto Snap app to enter [Camera Settings]. On first use, be sure to calibrate the “Tilt Sensor” and “Format” the microSD card.

1 Calibrate the Tilt Sensor

Hold your motorcycle upright, straight, and as still as possible, then tap on “Tilt Sensor” in the menu so the Moto Snap can calibrate the internal tilt sensor. After calibration is completed, if the camera detects that the motorcycle is toppled over, it will trigger emergency recording automatically. This is indicated by the blue LED going from a slow flash to a rapid flash.

Emergency recordings are stored in the emergency video folder.

2 Format microSD card

Tap “Format” in the menu to format microSD card. It is recommended to format your card at least once a month to ensure that it is working properly.



Note :

1. When the Moto Snap is inserted into Snap Mount (or used with the optional carry-on Power Key), it will automatically power on and start recording, indicated by a slow-flashing blue LED indicator light. The recording file will be saved onto the microSD card. When the card reaches capacity, the loop recording function will overwrite the oldest file to make room for new files and continue recording.

2. Memory cards have a service life. Long-term use may lead to write speed degradation and file save failures. If this happens, it is recommended that you purchase a new memory card.

Step 9: Change Password

To change the Wi-Fi password, follow the steps below. If left unchanged, the default password is 12345678.

- 1 Open the Moto Snap app , and tap  to enter [Camera Setting]. Next, tap [Wi-Fi Password].



- Enter the old password. (Default password: **12345678**)
- Enter your new password.
 - Enter your new password again to confirm.
 - tap “Yes”, and screen will show message of “Setting Success, Connect Wi-Fi again”
 - close app, and follow by step **2** to re-connect Wi-Fi

- 2 iPhone users: Open the Wi-Fi connection menu and tap the MotoSnap network. Next, tap “Forget This Network” and confirm your decision.

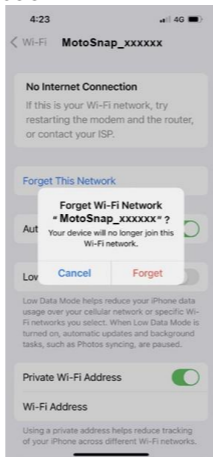

*Note: Android phone user can skip this step.







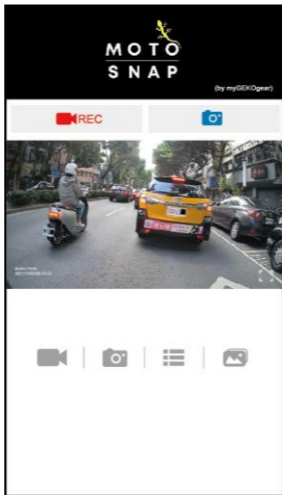

- 3 Next, tap the MotoSnap network again to re-enter your new password and reconnect your smartphone to the Moto Snap.

Note: Be sure to remember your new password. If you forget your new password, a factory reset will be necessary.

Step 10: App Operation

1 Main Screen





icon	Description
	Start/Stop Recording
	Take snapshot
	Recorded videos
	Pictures
	Camera Setting
	Local Album (review downloaded files on your smartphone)
	Full screen preview
	Preview image

Note:



1. The Moto Snap App will auto sync the camera's date/time with your smartphone.
2. App layout and features are subject to change, depending on the software version. Refer to the Google Play or iOS App Store for the latest updates.

2 Playback, delete, and download recordings

Use this feature to playback, delete recordings, or download recordings from the Moto Snap to your smartphone.

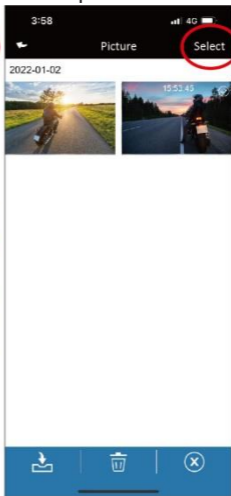
1. Tap the icon  [Video playback] or  [Picture playback] to enter file playback list. Recording will stop.
2. The files saved in the Moto Snap's microSD card will be listing on your smart phone. Tap the preview thumbnail to playback.
3. Tap the right top corner "Select" and pick up the files that you want to delete or download and tap below icon to execute.



Icon	Description
	Download file to smartphone
	Delete file
	Exit

Note :

1. If recordings have no audio, check if Audio Recording is OFF in the menu. For video playback, we recommend VLC Media Player.
2. Deleted files cannot be recovered. Backup any important files before deleting them.
3. **If you plan to download a large number of videos and photos, we recommend connecting directly to a PC/Mac via USB Type-C cable.**

3 Local Album

You can use this feature to playback or delete the file that you download to your smart phone.

1. Tap the icon  [Local Album]. The camera will stop recording.
2. Tap the file from preview thumbnail you are going to playback.
3. Tap the right top corner “Select” and pick up the files that

you want to delete, and tap icon  to execute.

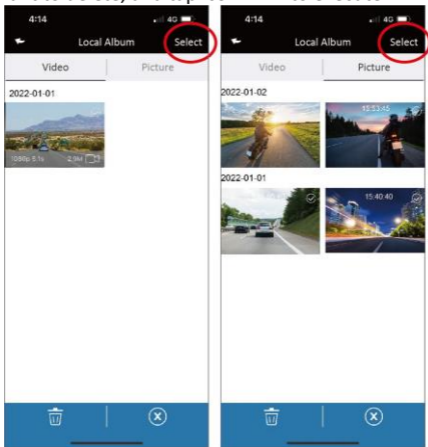

Camera Setting

You can use this feature to set up your preferred options.

1. Tap icon  [Camera Setting] on main screen. The camera will stop recording.
2. See available settings below and adjust to your preferred options.

Menu	Description	Options
Recording Interval	Set the length of each individual recording.	1min / 3min / 5min
Time Lapse	In Time Lapse mode, the camera will record one frame per second.	On / Off
Audio Recording	Enable/Disable audio recording.	On / Off
AI Noise Reduction	AI Noise Reduction suppresses surrounding noises so conversations are more audible in recordings.	On / Off
Flicker Frequency	Flicker frequency (Hz) varies by country/region. (USA/Canada: 60Hz)	50Hz / 60Hz
Tilt Sensor	Calibrate the Tilt-Sensor for topple-over detection.	Yes / No
Default Settings	Reset the camera to factory default settings.	Yes / No

Format	Format the memory card in the Moto Snap. This will delete all contents permanently.	Yes / No
Wi-Fi Turn-on Time	Set the Wi-Fi activation duration. *Active Wi-Fi will decrease total recording hours	Always on / 3min off
Wi-Fi Password	Change the Wi-Fi password. (Default: 12345678)	
Firmware Version	Indicates the current firmware version of the Moto Snap.	
APP Version	Indicates the current application version.	

Step 11: Final Check

- Peel off lens protective film**
- Fully charge the camera (Red LED off)**
- Tilt Sensor calibration done**
- Format microSD card done**
- MicroSD card slot cover is closed tightly**
- All Mounts are fixed tightly**
- The safety cord from the main unit is secured to the safety ring on the mount.**

Specifications









Item	Description
Image Sensor	SONY's Starvis Sensor
Effective Pixels	1920 (H) x 1080 (V)
Storage Media	Suggest V30 or higher microSD card, up to 128GB
Lens	Wide angle fixed focus lens Aperture : up to F/2.2
Video File	Resolution : 1080P/ 30 fps
	Format : TS
Picture File	Use App to take snapshot
	Format : JPG
G-Sensor	3-AxIs G-Force sensor
Microphone	Built-in
Battery	3200mAh
Operating Temperature	-10° ~ 60° C
Operating Humidity	20 ~ 70% RH
Storage Temperature	-20° ~ 70° C
Moto Snap Size	107 x 32 x 29 mm
Moto Snap Weight	Approximately 96g

Built-in IEEE 802.11g/n (HT20) Wi-Fi chip: RTL8188FTV

Wi-Fi Frequency	2412~2462MHz
Wi-Fi Channel	Ch1~Ch11

Optional Accessories

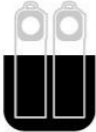
Please visit our official website www.mygekogear.com to purchase additional accessories for the Moto Snap.

Helmet Mount 	Rear-mirror Mount 	Adjustable Mount 
Car Plate Mount 	Shoulder Band 	Pouch 
Charging Bin 	Power Key 	



Buttonless Design.
Built-in ON/OFF
sensor detects when
the camera is
snapped in and
automatically begins
recording



Easy DIY Installation



High-capacity battery
for up to 8.5 hours of
continuous recording
(max recording hours
may vary, depending
on current battery
life)



IP66 Water Resistance



Sony STARVIS Sensor
captures excellent
recordings, even at
night.



AI Noise Reduction



TS Video Format



Tilt Sensor detects if
the vehicle has
tipped over and
automatically locks
the recording.



Dedicated Moto Snap
app for adjusting the
camera's settings and
reviewing recordings.



Optional accessories
are available to use
the Moto Snap in
various other
applications.

Technical Support

For technical support please contact our service team:

service@mygekogear.com

Limited Warranty

Our products carry a 12-Month limited warranty from the date of purchase, covering manufacturing defects or faults in workmanship. For questions, support, or warranty claims, contact us at service@mygekogear.com.

***IMPORTANT:** Proof of original purchase is required for warranty service.