

---

# SAR Test Report

---

Report No.: AGC02762230801FH01

**FCC ID** : 2AL26-K7-US

**APPLICATION PURPOSE** : Original Equipment

**PRODUCT DESIGNATION** : Body Worn Camera

**BRAND NAME** : Reveal Media

**MODEL NAME** : K7

**APPLICANT** : Reveal Media Limited

**DATE OF ISSUE** : Jan. 08, 2024

**STANDARD(S)** : IEEE Std. 1528:2013  
FCC 47 CFR Part 2§2.1093  
IEEE Std C95.1™-2005

**REPORT VERSION** : V1.0

Attestation of Global Compliance (Shenzhen) Co., Ltd.



Any report having not been signed by authorized approver, or having been altered without authorization, or having not been stamped by the "Dedicated Testing/Inspection Stamp" is deemed to be invalid. Copying or excerpting portion of, or altering the content of the report is not permitted without the written authorization of AGC. The test results presented in the report apply only to the tested sample. Any objections to report issued by AGC should be submitted to AGC within 15days after the issuance of the test report. Further enquiry of validity or verification of the test report should be addressed to AGC by [agc01@agccert.com](mailto:agc01@agccert.com).

Attestation of Global Compliance(Shenzhen)Co., Ltd  
Attestation of Global Compliance(Shenzhen)Std & Tech Co., Ltd  
Tel: +86-755 2523 4088 E-mail: [agc@agccert.com](mailto:agc@agccert.com) Web: <http://www.agccert.com/>



### Report Revise Record

Report Version	Revise Time	Issued Date	Valid Version	Notes
V1.0	/	Jan. 08, 2024	Valid	Initial Release

Any report having not been signed by authorized approver, or having been altered without authorization, or having not been stamped by the "Dedicated Testing/Inspection Stamp" is deemed to be invalid. Copying or excerpting portion of, or altering the content of the report is not permitted without the written authorization of AGC. The test results presented in the report apply only to the tested sample. Any objections to report issued by AGC should be submitted to AGC within 15days after the issuance of the test report. Further enquiry of validity or verification of the test report should be addressed to AGC by [agc01@agccert.com](mailto:agc01@agccert.com).

Test Report	
Applicant Name	Reveal Media Limited
Applicant Address	Riverview House, 20 Old Bridge Street, Hampton Wick, KT1 4BU, United Kingdom
Manufacturer Name	Reveal Media Hong Kong Ltd.
Manufacturer Address	6/F., Luk Kwok Centre, 72 Gloucester Road, Wan Chai, HongKong
Factory Name	Reveal Media Hong Kong Ltd.
Factory Address	6/F., Luk Kwok Centre, 72 Gloucester Road, Wan Chai, HongKon
Product Designation	Body Worn Camera
Brand Name	Reveal Media
Model Name	K7
EUT Voltage	DC3.8V by battery
Applicable Standard	IEEE Std. 1528:2013 FCC 47 CFR Part 2§2.1093 IEEE Std C95.1™-2005
Date of receipt of test item	Aug. 03, 2023
Test Date	Dec. 01, 2023 to Dec. 22, 2023
Report Template	AGCRT-US-4G/SAR (2021-04-20)

Note: The results of testing in this report apply to the product/system which was tested only.

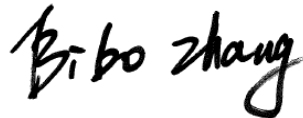
Prepared By   
 \_\_\_\_\_  
 Bibo Zhang (Project Engineer) Jan. 08, 2024

Reviewed By   
 \_\_\_\_\_  
 Calvin Liu (Reviewer) Jan. 08, 2024

Approved By   
 \_\_\_\_\_  
 Max Zhang (Authorized Officer) Jan. 08, 2024

Any report having not been signed by authorized approver, or having been altered without authorization, or having not been stamped by the "Dedicated Testing/Inspection Stamp" is deemed to be invalid. Copying or excerpting portion of, or altering the content of the report is not permitted without the written authorization of AGC. The test results presented in the report apply only to the tested sample. Any objections to report issued by AGC should be submitted to AGC within 15days after the issuance of the test report. Further enquiry of validity or verification of the test report should be addressed to AGC by agc01@agccert.com.

## TABLE OF CONTENTS

<b>1. SUMMARY OF MAXIMUM SAR VALUE .....</b>	<b>5</b>
<b>2. GENERAL INFORMATION.....</b>	<b>6</b>
2.1. EUT DESCRIPTION.....	6
<b>3. SAR MEASUREMENT SYSTEM.....</b>	<b>8</b>
3.1. THE SATIMO SYSTEM USED FOR PERFORMING COMPLIANCE TESTS CONSISTS OF FOLLOWING ITEMS .....	8
3.2. COMOSAR E-FIELD PROBE .....	9
3.3. ROBOT.....	9
3.4. VIDEO POSITIONING SYSTEM .....	10
3.5. DEVICE HOLDER .....	10
3.6. SAM TWIN PHANTOM.....	11
<b>4. SAR MEASUREMENT PROCEDURE.....</b>	<b>12</b>
4.1. SPECIFIC ABSORPTION RATE (SAR).....	12
4.2. SAR MEASUREMENT PROCEDURE .....	13
4.3. RF EXPOSURE CONDITIONS .....	15
<b>5. TISSUE SIMULATING LIQUID.....</b>	<b>17</b>
5.1. THE COMPOSITION OF THE TISSUE SIMULATING LIQUID.....	17
5.2. TISSUE DIELECTRIC PARAMETERS FOR HEAD AND BODY PHANTOMS .....	18
5.3. TISSUE CALIBRATION RESULT .....	19
<b>6. SAR SYSTEM CHECK PROCEDURE .....</b>	<b>21</b>
6.1. SAR SYSTEM CHECK PROCEDURES .....	21
6.2. SAR SYSTEM CHECK.....	22
<b>7. EUT TEST POSITION.....</b>	<b>24</b>
7.1. TEST POSITION.....	24
<b>8. SAR EXPOSURE LIMITS .....</b>	<b>25</b>
<b>9. TEST FACILITY .....</b>	<b>26</b>
<b>10. TEST EQUIPMENT LIST .....</b>	<b>27</b>
<b>11. MEASUREMENT UNCERTAINTY .....</b>	<b>28</b>
<b>12. CONDUCTED POWER MEASUREMENT.....</b>	<b>31</b>
<b>13. TEST RESULTS.....</b>	<b>60</b>
13.1. SAR TEST RESULTS SUMMARY.....	60
<b>APPENDIX A. SAR SYSTEM CHECK DATA .....</b>	<b>93</b>
<b>APPENDIX B. SAR MEASUREMENT DATA .....</b>	<b>111</b>
<b>APPENDIX C. TEST SETUP PHOTOGRAPHS.....</b>	<b>169</b>
<b>APPENDIX D. CALIBRATION DATA .....</b>	<b>176</b>

Any report having not been signed by authorized approver, or having been altered without authorization, or having not been stamped by the “Dedicated Testing/Inspection Stamp” is deemed to be invalid. Copying or excerpting portion of, or altering the content of the report is not permitted without the written authorization of AGC. The test results presented in the report apply only to the tested sample. Any objections to report issued by AGC should be submitted to AGC within 15days after the issuance of the test report. Further enquiry of validity or verification of the test report should be addressed to AGC by agc01@agccert.com.

## 1. SUMMARY OF MAXIMUM SAR VALUE

The maximum results of Specific Absorption Rate (SAR) found during testing for EUT are as follows:

Frequency Band	Highest Reported 1g-SAR(W/kg)		SAR Test Limit (W/kg)
	Body-worn(with 0mm separation)	Hotspot(with 0mm separation)	
UMTS Band II	1.283	1.283	1.6
UMTS Band IV	1.207	1.207	
UMTS Band V	1.388	1.388	
LTE Band 2	1.342	1.342	
LTE Band 4	1.306	1.306	
LTE Band 5	1.364	1.364	
LTE Band 12	1.277	1.277	
LTE Band 13	1.339	1.339	
LTE Band 14	1.277	1.277	
LTE Band 66	1.304	1.304	
LTE Band 71	1.350	1.350	
WIFI 2.4G	0.377	0.377	
5.2GHz (U-NII-1)	0.350	0.350	
5.3GHz (U-NII-2A)	0.396	0.396	
5.6GHz (U-NII-2C)	0.376	0.376	
5.8GHz (U-NII-3)	0.309	0.309	
Simultaneous Reported SAR	1.470		
SAR Test Result	PASS		

This device is compliance with Specific Absorption Rate (SAR) for general population/uncontrolled exposure limits (1.6W/kg) specified in IEEE Std. 1528:2013; FCC 47CFR § 2.1093; IEEE/ANSI C95.1:2005 and the following specific FCC Test Procedures:

- KDB 447498 D01 General RF Exposure Guidance v06
- KDB 648474 D04 Handset SAR v01r03
- KDB 865664 D01 SAR Measurement 100MHz to 6GHz v01r04
- KDB 941225 D01 3G SAR Procedures v03r01
- KDB 941225 D06 Hotspot Mode v02r01
- KDB 248227 D01 802 11 Wi-Fi SAR v02r02
- KDB 941225 D05 SAR for LTE Devices v02r05

Any report having not been signed by authorized approver, or having been altered without authorization, or having not been stamped by the "Dedicated Testing/Inspection Stamp" is deemed to be invalid. Copying or excerpting portion of, or altering the content of the report is not permitted without the written authorization of AGC. The test results presented in the report apply only to the tested sample. Any objections to report issued by AGC should be submitted to AGC within 15days after the issuance of the test report. Further enquiry of validity or verification of the test report should be addressed to AGC by agc01@agccert.com.

## 2. GENERAL INFORMATION

### 2.1. EUT Description

General Information	
Product Designation	Body Worn Camera
Test Model	K7
Sample ID	230803004
Hardware Version	EP-VRM04MB-05
Software Version	V1.0
Device Category	Portable
RF Exposure Environment	Uncontrolled
Antenna Type	Internal
WCDMA	
Support Band	<input checked="" type="checkbox"/> UMTS FDD Band II <input checked="" type="checkbox"/> UMTS FDD Band V <input checked="" type="checkbox"/> UMTS FDD Band IV <input type="checkbox"/> UMTS FDD Band I <input type="checkbox"/> UMTS FDD Band III <input type="checkbox"/> UMTS FDD Band VIII
HS Type	HSPA(HSUPA/HSDPA)
TX Frequency Range	FDD Band II: 1850-1910MHz; FDD Band V: 824-849MHz FDD Band IV: 1710-1770MHz
RX Frequency Range	FDD Band II: 1930-1990MHz; FDD Band V: 869-894MHz FDD Band IV: 2110-2170MHz
Release Version	Rel-6
Type of modulation	HSDPA:QPSK/16QAM; HSUPA:BPSK; WCDMA:QPSK
Antenna Gain	Band II: -0.12dBi; Band IV: -0.2dBi; Band V: -2.05dBi
Max. Average Power	Band II: 23.73dBm; Band IV: 23.93dBm; Band V: 23.01dBm
Bluetooth	
Bluetooth Version	V5.0
Operation Frequency	2402~2480MHz
Type of modulation	GFSK
Peak Power	2.882dBm
Antenna Gain	-2.54dBi
2.4GHz WIFI	
WIFI Specification	<input type="checkbox"/> 802.11a <input checked="" type="checkbox"/> 802.11b <input checked="" type="checkbox"/> 802.11g <input checked="" type="checkbox"/> 802.11n(20) <input type="checkbox"/> 802.11n(40)
Operation Frequency	2412~2462MHz
Avg. Burst Power	11b: 14.51dBm, 11g:13.94dBm, 11n(20):13.45dBm
Antenna Gain	1.15dBi

Any report having not been signed by authorized approver, or having been altered without authorization, or having not been stamped by the "Dedicated Testing/Inspection Stamp" is deemed to be invalid. Copying or excerpting portion of, or altering the content of the report is not permitted without the written authorization of AGC. The test results presented in the report apply only to the tested sample. Any objections to report issued by AGC should be submitted to AGC within 15days after the issuance of the test report. Further enquiry of validity or verification of the test report should be addressed to AGC by agc01@agccert.com.

**EUT Description( Continue)**

<b>LTE</b>	
Support Band	<input checked="" type="checkbox"/> FDD Band 2 <input checked="" type="checkbox"/> FDD Band 4 <input checked="" type="checkbox"/> FDD Band 5 <input type="checkbox"/> FDD Band 7 <input checked="" type="checkbox"/> FDD Band 12 <input checked="" type="checkbox"/> FDD Band 13 <input checked="" type="checkbox"/> FDD Band 14 <input type="checkbox"/> FDD Band 17 <input type="checkbox"/> FDD Band 25 <input type="checkbox"/> FDD Band 26 <input type="checkbox"/> TDD Band 38 <input type="checkbox"/> TDD Band 40 <input type="checkbox"/> TDD Band 41 <input checked="" type="checkbox"/> FDD Band 66 <input checked="" type="checkbox"/> FDD Band 71
TX Frequency Range	Band 2:1850-1910MHz; Band 4:1710-1755MHz; Band 5:824-849MHz; Band 12:699-716MHz; Band 13: 777-787MHz; Band 14: 788-798MHz; Band 66:1700-1780MHz; Band 71:663-698MHz
RX Frequency Range	Band 2:1930-1990MHz; Band 4:2110-2155MHz; Band 5:869-894MHz; Band 12: 729-746 MHz; Band 13: 746-756MHz; Band 14: 758-768 MHz; Band 66:2110-2200MHz; Band 71:617-652MHz
Release Version	Rel-8
Type of modulation	QPSK, 16QAM
Antenna Gain	Band 2: -0.12dBi; Band 4: -0.2dBi; Band 5: -2.85dBi; Band 12: -2.36dBi; Band 13: -2.29dBi; Band 14: -2.3dBi; Band 66: -0.15dBi; Band 71: -3.96dBi;
Max. Average Power	Band 2: 23.60dBm; Band 4: 23.89dBm; Band 5: 23.91dBm; Band 12: 24.33dBm; Band 13: 22.79dBm; Band 14: 23.04dBm; Band 66: 23.39dBm; Band 71: 19.90 dBm;
<b>5 GHz WIFI</b>	
WIFI Specification	<input checked="" type="checkbox"/> 802.11a <input checked="" type="checkbox"/> 802.11n20 <input checked="" type="checkbox"/> 802.11n40 <input checked="" type="checkbox"/> 802.11ac20 <input checked="" type="checkbox"/> 802.11ac40 <input checked="" type="checkbox"/> 802.11ac80
Operation Frequency	U-NII-1: 5180MHz~5240MHz; U-NII-2A: 5260MHz~5320MHz; U-NII-2C: 5470MHz~5725MHz;U-NII-3: 5745MHz~5825MHz
Max. conducted Power	U-NII-1: 12.48dBm; U-NII-2A: 11.72dBm; U-NII-2C: 10.74dBm; U-NII-3: 10.95dBm
Antenna Gain	1.82dBi
<b>Accessories</b>	
Battery	Brand name: N/A Model No. : IBR036GA Voltage and Capacitance: 3.8 V & 4500mAh
Earphone	Brand name: N/A Model No. : N/A

- Note:1.CMU200 can measure the average power and Peak power at the same time  
 2.The sample used for testing is end product.  
 3. The test sample has no any deviation to the test method of standard mentioned in page 1.

Product	Type
	<input checked="" type="checkbox"/> Production unit <input type="checkbox"/> Identical Prototype

Any report having not been signed by authorized approver, or having been altered without authorization, or having not been stamped by the “Dedicated Testing/Inspection Stamp” is deemed to be invalid. Copying or excerpting portion of, or altering the content of the report is not permitted without the written authorization of AGC. The test results presented in the report apply only to the tested sample. Any objections to report issued by AGC should be submitted to AGC within 15days after the issuance of the test report. Further enquiry of validity or verification of the test report should be addressed to AGC by agc01@agccert.com.

### 3. SAR MEASUREMENT SYSTEM

#### 3.1. The SATIMO system used for performing compliance tests consists of following items

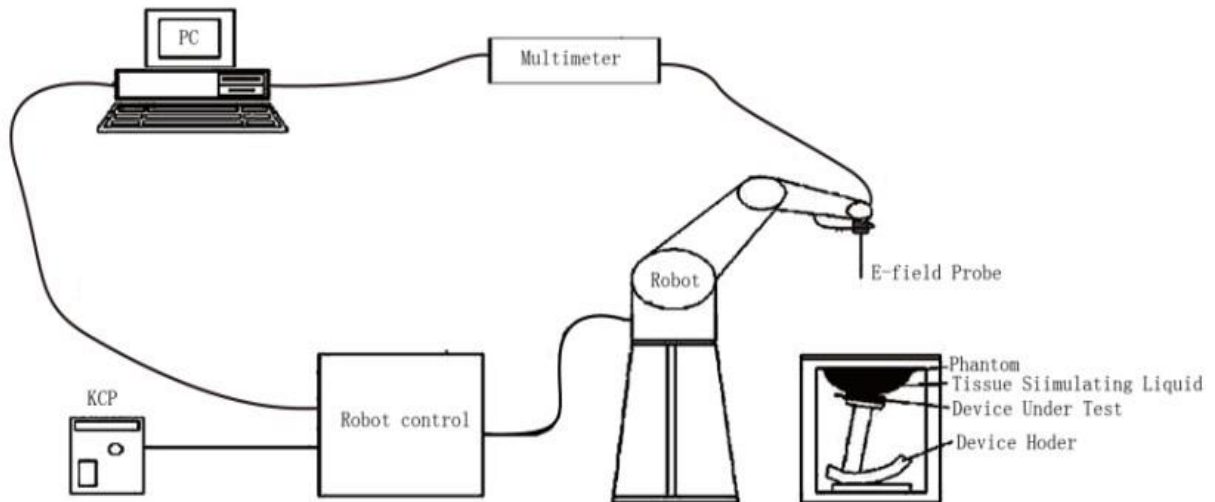

The COMOSAR system for performing compliance tests consists of the following items:

- The PC. It controls most of the bench devices and stores measurement data. A computer running WinXP and the Opensar software.
- The E-Field probe. The probe is a 3-axis system made of 3 distinct dipoles. Each dipole returns a voltage in function of the ambient electric field.
- The Keithley multimeter measures each probe dipole voltages.
- The SAM phantom simulates a human head. The measurement of the electric field is made inside the phantom.
- The liquids simulate the dielectric properties of the human head tissues.
- The network emulator controls the mobile phone under test.
- The validation dipoles are used to measure a reference SAR. They are used to periodically check the bench to make sure that there is no drift of the system characteristics over time.
- The phantom, the device holder and other accessories according to the targeted measurement.

Any report having not been signed by authorized approver, or having been altered without authorization, or having not been stamped by the "Dedicated Testing/Inspection Stamp" is deemed to be invalid. Copying or excerpting portion of, or altering the content of the report is not permitted without the written authorization of AGC. The test results presented in the report apply only to the tested sample. Any objections to report issued by AGC should be submitted to AGC within 15days after the issuance of the test report. Further enquiry of validity or verification of the test report should be addressed to AGC by agc01@agccert.com.



### 3.2. COMOSAR E-Field Probe

The SAR measurement is conducted with the dosimetric probe manufactured by SATIMO. The probe is specially designed and calibrated for use in liquid with high permittivity. The dosimetric probe has special calibration in liquid at different frequency. SATIMO conducts the probe calibration in compliance with international and national standards (e.g. IEEE 1528 and relevant KDB files.) The calibration data are in Appendix D.

#### Isotropic E-Field Probe Specification

<b>Model</b>	SSE2	
<b>Manufacture</b>	MVG	
<b>Identification No.</b>	2023-EPGO-414	
<b>Frequency</b>	0.15GHz-7.5GHz Linearity:±0.09dB(0.15GHz-7.5GHz)	
<b>Dynamic Range</b>	0.01W/kg-100W/kg Linearity:±0.09dB	
<b>Dimensions</b>	Overall length:330mm Length of individual dipoles:24.5mm Maximum external diameter:8mm Probe Tip external diameter:2.55mm Distance between dipoles/ probe extremity:12.7mm	
<b>Application</b>	High precision dosimetric measurements in any exposure scenario (e.g., very strong gradient fields). Only probe which enables compliance testing for frequencies up to 6 GHz with precision of better 30%.	

### 3.3. Robot

<p>The COMOSAR system uses the KUKA robot from SATIMO SA (France).For the 6-axis controller COMOSAR system, the KUKA robot controller version from SATIMO is used.</p> <p>The XL robot series have many features that are important for our application:</p> <ul style="list-style-type: none"> <li><input type="checkbox"/> High precision (repeatability 0.02 mm)</li> <li><input type="checkbox"/> High reliability (industrial design)</li> <li><input type="checkbox"/> Jerk-free straight movements</li> <li><input type="checkbox"/> Low ELF interference (the closed metallic construction shields against motor control fields)</li> <li><input type="checkbox"/> 6-axis controller</li> </ul>	
---	---

Any report having not been signed by authorized approver, or having been altered without authorization, or having not been stamped by the “Dedicated Testing/Inspection Stamp” is deemed to be invalid. Copying or excerpting portion of, or altering the content of the report is not permitted without the written authorization of AGC. The test results presented in the report apply only to the tested sample. Any objections to report issued by AGC should be submitted to AGC within 15days after the issuance of the test report. Further enquiry of validity or verification of the test report should be addressed to AGC by agc01@agccert.com.

### 3.4. Video Positioning System

The video positioning system is used in OpenSAR to check the probe. Which is composed of a camera, LED, mirror and mechanical parts. The camera is piloted by the main computer with firewire link. During the process, the actual position of the probe tip with respect to the robot arm is measured, as well as the probe length and the horizontal probe offset. The software then corrects all movements, such that the robot coordinates are valid for the probe tip. The repeatability of this process is better than 0.1 mm. If a position has been taught with an aligned probe, the same position will be reached with another aligned probe within 0.1 mm, even if the other probe has different dimensions. During probe rotations, the probe tip will keep its actual position.

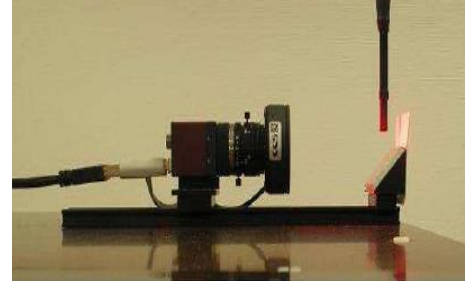

### 3.5. Device Holder

The COMOSAR device holder is designed to cope with different positions given in the standard. It has two scales for the device rotation (with respect to the body axis) and the device inclination (with respect to the line between the ear reference points). The rotation center for both scales is the ear reference point (EPR). Thus the device needs no repositioning when changing the angles. The COMOSAR device holder has been made out of low-loss POM material having the following dielectric parameters: relative permittivity  $\epsilon_r = 3$  and loss tangent  $\delta = 0.02$ . The amount of dielectric material has been reduced in the closest vicinity of the device, since measurements have suggested that the influence of the clamp on the test results could thus be lowered.

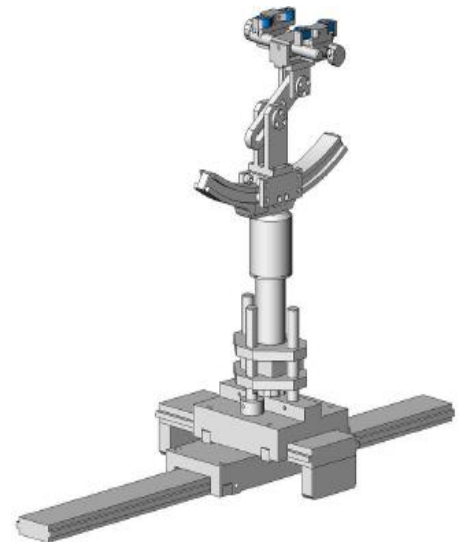

### 3.6. SAM Twin Phantom

The SAM twin phantom is a fiberglass shell phantom with 2mm shell thickness (except the ear region where shell thickness increases to 6mm). It has three measurement areas:

- Left head
- Right head
- Flat phantom



The bottom plate contains three pair of bolts for locking the device holder. The device holder positions are adjusted to the standard measurement positions in the three sections. A white cover is provided to tap the phantom during off-periods to prevent water evaporation and changes in the liquid parameters. On the phantom top, three reference markers are provided to identify the phantom position with respect to the robot.

Any report having not been signed by authorized approver, or having been altered without authorization, or having not been stamped by the “Dedicated Testing/Inspection Stamp” is deemed to be invalid. Copying or excerpting portion of, or altering the content of the report is not permitted without the written authorization of AGC. The test results presented in the report apply only to the tested sample. Any objections to report issued by AGC should be submitted to AGC within 15days after the issuance of the test report. Further enquiry of validity or verification of the test report should be addressed to AGC by [agc01@agccert.com](mailto:agc01@agccert.com).

## 4. SAR MEASUREMENT PROCEDURE

### 4.1. Specific Absorption Rate (SAR)

SAR is related to the rate at which energy is absorbed per unit mass in object exposed to a radio field. The SAR distribution in a biological body is complicated and is usually carried out by experimental techniques or numerical modeling. The standard recommends limits for two tiers of groups, occupational/controlled and occupational/uncontrolled, based on a person's awareness and ability to exercise control over his or her exposure. In general, occupational/controlled exposure limits are higher than the limits for general population/uncontrolled.

The SAR definition is the time derivative (rate) of the incremental energy (dW) absorbed by (dissipated in) an incremental mass (dm) contained in a volume element(dv) of given mass density (ρ). The equation description is as below:

$$SAR = \frac{d}{dt} \left( \frac{dW}{dm} \right) = \frac{d}{dt} \left( \frac{dW}{\rho dV} \right)$$

SAR is expressed in units of Watts per kilogram (W/kg)

SAR can be obtained using either of the following equations:

$$SAR = \frac{\sigma E^2}{\rho}$$

$$SAR = c_h \left. \frac{dT}{dt} \right|_{t=0}$$

Where

SAR	is the specific absorption rate in watts per kilogram;
E	is the r.m.s. value of the electric field strength in the tissue in volts per meter;
σ	is the conductivity of the tissue in siemens per metre;
ρ	is the density of the tissue in kilograms per cubic metre;
c <sub>h</sub>	is the heat capacity of the tissue in joules per kilogram and Kelvin;

$\left. \frac{dT}{dt} \right|_{t=0}$  is the initial time derivative of temperature in the tissue in kelvins per second

## 4.2. SAR Measurement Procedure

### Step 1: Power Reference Measurement

The Power Reference Measurement and Power Drift Measurement are for monitoring the power drift of the device under test in the batch process. The minimum distance of probe sensors to surface is 2.7mm This distance cannot be smaller than the distance os sensor calibration points to probe tip as defined in the probe properties,

### Step 2: Area Scan

The Area Scan is used as a fast scan in two dimensions to find the area of high field values, before doing a fine measurement around the hot spot. The sophisticated interpolation routines implemented in SATIMO software can find the maximum locations even in relatively coarse grids. When an Area Scan has measured all reachable points, it computes the field maximal found in the scanned area, within a range of the global maximum. The range (in db) is specified in the standards for compliance testing. For example, a 2db range is required in IEEE Standard 1528 standards, whereby 3db is a requirement when compliance is assessed in accordance with the ARIB standard (Japan) If one Zoom Scan follows the Area Scan, then only the absolute maximum will be taken as reference. For cases where multiple maximum are detected, the number of Zoom Scan has to be increased accordingly.

Area Scan Parameters extracted from KDB 865664 D01 SAR Measurement 100MHz to 6GHz

	≤ 3 GHz	> 3 GHz
Maximum distance from closest measurement point (geometric center of probe sensors) to phantom surface	5 ± 1 mm	$\frac{1}{2} \cdot \delta \cdot \ln(2) \pm 0.5$ mm
Maximum probe angle from probe axis to phantom surface normal at the measurement location	30° ± 1°	20° ± 1°
Maximum area scan spatial resolution: $\Delta x_{Area}$ , $\Delta y_{Area}$	≤ 2 GHz: ≤ 15 mm 2 – 3 GHz: ≤ 12 mm	3 – 4 GHz: ≤ 12 mm 4 – 6 GHz: ≤ 10 mm
	When the x or y dimension of the test device, in the measurement plane orientation, is smaller than the above, the measurement resolution must be ≤ the corresponding x or y dimension of the test device with at least one measurement point on the test device.	

### Step 3: Zoom Scan

Zoom Scan are used to assess the peak spatial SAR value within a cubic average volume containing 1g abd 10g of simulated tissue. The Zoom Scan measures points(refer to table below) within a cube whose base faces are centered on the maxima found in a preceding area scan job within the same procedure. When the measurement is done, the Zoom Scan evaluates the averaged SAR for 1g and 10g and displays these values next to the job's label.

Any report having not been signed by authorized approver, or having been altered without authorization, or having not been stamped by the “Dedicated Testing/Inspection Stamp” is deemed to be invalid. Copying or excerpting portion of, or altering the content of the report is not permitted without the written authorization of AGC. The test results presented in the report apply only to the tested sample. Any objections to report issued by AGC should be submitted to AGC within 15days after the issuance of the test report. Further enquiry of validity or verification of the test report should be addressed to AGC by agc01@agccert.com.

Zoom Scan Parameters extracted from KDB865664 d01 SAR Measurement 100MHz to 6GHz

Maximum zoom scan spatial resolution: $\Delta x_{Zoom}$ , $\Delta y_{Zoom}$		$\leq 2$ GHz: $\leq 8$ mm 2 – 3 GHz: $\leq 5$ mm*	3 – 4 GHz: $\leq 5$ mm* 4 – 6 GHz: $\leq 4$ mm*
Maximum zoom scan spatial resolution, normal to phantom surface	uniform grid: $\Delta z_{Zoom}(n)$	$\leq 5$ mm	3 – 4 GHz: $\leq 4$ mm 4 – 5 GHz: $\leq 3$ mm 5 – 6 GHz: $\leq 2$ mm
	graded grid	$\Delta z_{Zoom}(1)$ : between 1 <sup>st</sup> two points closest to phantom surface	$\leq 4$ mm
		$\Delta z_{Zoom}(n>1)$ : between subsequent points	$\leq 1.5 \cdot \Delta z_{Zoom}(n-1)$
Minimum zoom scan volume	x, y, z	$\geq 30$ mm	3 – 4 GHz: $\geq 28$ mm 4 – 5 GHz: $\geq 25$ mm 5 – 6 GHz: $\geq 22$ mm
<p>Note: <math>\delta</math> is the penetration depth of a plane-wave at normal incidence to the tissue medium; see draft standard IEEE P1528-2011 for details.</p> <p>* When zoom scan is required and the <i>reported</i> SAR from the <i>area scan based 1-g SAR estimation</i> procedures of KDB 447498 is <math>\leq 1.4</math> W/kg, <math>\leq 8</math> mm, <math>\leq 7</math> mm and <math>\leq 5</math> mm zoom scan resolution may be applied, respectively, for 2 GHz to 3 GHz, 3 GHz to 4 GHz and 4 GHz to 6 GHz.</p>			

Step 4: Power Drift Measurement

The Power Drift Measurement measures the field at the same location as the most recent power reference measurement within the same procedure, and with the same settings. The Power Drift Measurement gives the field difference in dB from the reading conducted within the same settings. This allows a user to monitor the power drift of the device under test within a batch process. The measurement procedure is the same as Step 1.

Any report having not been signed by authorized approver, or having been altered without authorization, or having not been stamped by the “Dedicated Testing/Inspection Stamp” is deemed to be invalid. Copying or excerpting portion of, or altering the content of the report is not permitted without the written authorization of AGC. The test results presented in the report apply only to the tested sample. Any objections to report issued by AGC should be submitted to AGC within 15days after the issuance of the test report. Further enquiry of validity or verification of the test report should be addressed to AGC by agc01@agccert.com.

### 4.3. RF Exposure Conditions

Test Configuration and setting:

The EUT is a model of GSM Portable Mobile Station (MS). It supports WCDMA/HSPA, LTE, BT, WIFI, and support hot spot mode.

For WWAN SAR testing, the device was controlled by using a base station emulator. Communication between the device and the emulator were established by air link. The distance between the EUT and the antenna is larger than 50cm, and the output power radiated from the emulator antenna is at least 30db smaller than the output power of EUT.

For WLAN testing, the EUT is configured with the WLAN continuous TX tool through engineering command.

#### Antenna Location: (the back view)

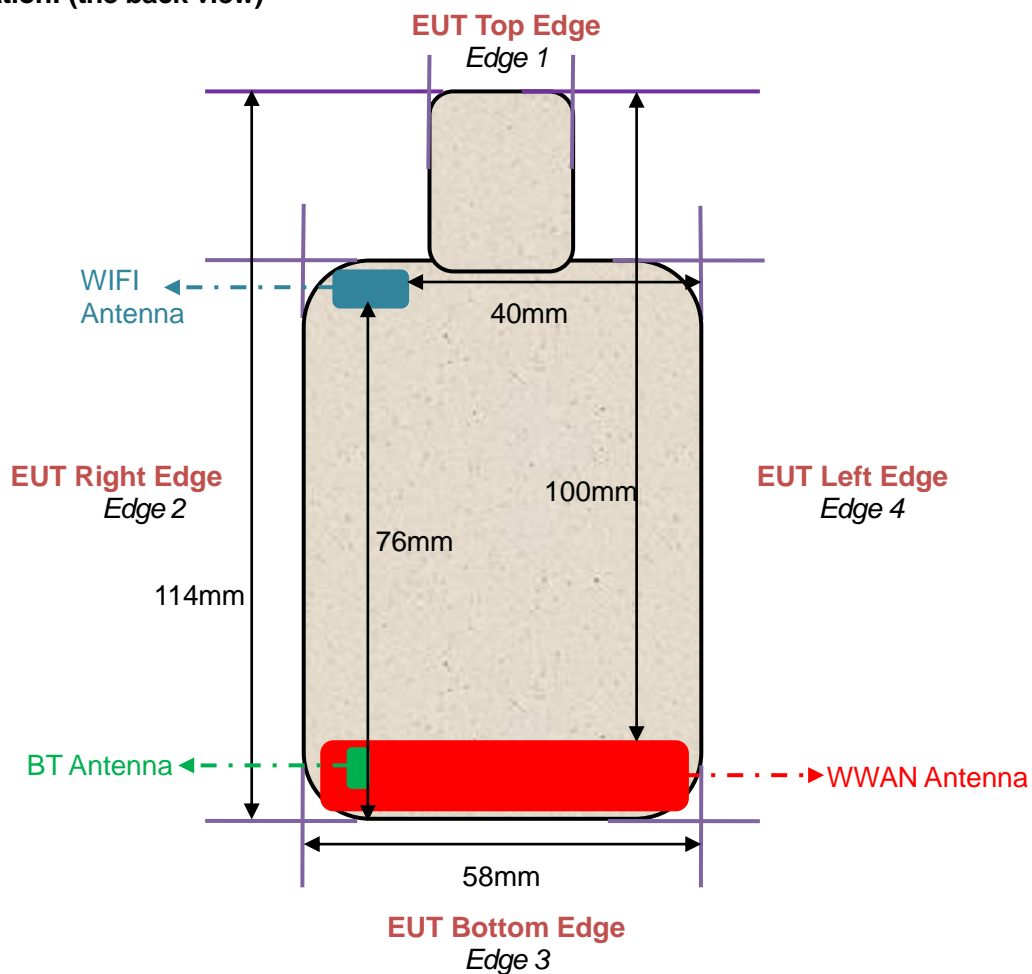

Any report having not been signed by authorized approver, or having been altered without authorization, or having not been stamped by the "Dedicated Testing/Inspection Stamp" is deemed to be invalid. Copying or excerpting portion of, or altering the content of the report is not permitted without the written authorization of AGC. The test results presented in the report apply only to the tested sample. Any objections to report issued by AGC should be submitted to AGC within 15days after the issuance of the test report. Further enquiry of validity or verification of the test report should be addressed to AGC by agc01@agccert.com.

For WWAN mode:

Test Configurations	Antenna to edges/surface	SAR required	Note
<b>Head</b>			
Left Touch		Yes	--
Left Tilt		Yes	--
Right Touch		Yes	--
Right Tilt		Yes	--
<b>Body</b>			
Back	<25mm	Yes	--
Front	<25mm	Yes	--
<b>Hotspot</b>			
Back	<25mm	Yes	--
Front	<25mm	Yes	--
Edge 1 (Top)	100mm	No	SAR is not required for the distance between the antenna and the edge is >25mm as per KDB 941225 D06 Hotspot SAR
Edge 2 (Right)	2mm	Yes	--
Edge 3 (Bottom)	2mm	Yes	--
Edge 4 (Left)	2mm	Yes	--

For WLAN mode:

Test Configurations	Antenna to edges/surface	SAR required	Note
<b>Head</b>			
Left Touch		Yes	--
Left Tilt		Yes	--
Right Touch		Yes	--
Right Tilt		Yes	--
<b>Body</b>			
Back	<25mm	Yes	--
Front	<25mm	Yes	--
<b>Hotspot</b>			
Back	<25mm	Yes	--
Front	<25mm	Yes	--
Edge 1 (Top)	29mm	No	SAR is not required for the distance between the antenna and the edge is >25mm as per KDB 941225 D06 Hotspot SAR
Edge 2 (Right)	4mm	Yes	--
Edge 3 (Bottom)	76mm	No	SAR is not required for the distance between the antenna and the edge is >25mm as per KDB 941225 D06 Hotspot SAR
Edge 4 (Left)	40mm	No	SAR is not required for the distance between the antenna and the edge is >25mm as per KDB 941225 D06 Hotspot SAR

Any report having not been signed by authorized approver, or having been altered without authorization, or having not been stamped by the "Dedicated Testing/Inspection Stamp" is deemed to be invalid. Copying or excerpting portion of, or altering the content of the report is not permitted without the written authorization of AGC. The test results presented in the report apply only to the tested sample. Any objections to report issued by AGC should be submitted to AGC within 15days after the issuance of the test report. Further enquiry of validity or verification of the test report should be addressed to AGC by agc01@agccert.com.



## 5. TISSUE SIMULATING LIQUID

For SAR measurement of the field distribution inside the phantom, the phantom must be filled with homogeneous tissue simulating liquid to a depth of at least 15cm. For head SAR testing the liquid height from the ear reference point (ERP) of the phantom to the liquid top surface is larger than 15cm For body SAR testing, the liquid height from the center of the flat phantom to the liquid top surface is larger than 15cm. The nominal dielectric values of the tissue simulating liquids in the phantom and the tolerance of 10% are listed in 6.2

### 5.1. The composition of the tissue simulating liquid

Frequency (MHz) \ Ingredient (% Weight)	Water	NaCl	Polysorbate 20	DGBE	1,2-Propanediol	Triton X-100	Diethylen glycol monohex ylether
750 Head	35	2	0.0	0.0	63	0.0	0.0
835 Head	50.36	1.25	48.39	0.0	0.0	0.0	0.0
1750 Head	52.64	0.36	0.0	47	0.0	0.0	0.0
1900 Head	54.9	0.18	0.0	44.92	0.0	0.0	0.0
2450 Head	71.88	0.16	0.0	7.99	0.0	19.97	0.0
5000 Head	65.52	0.0	0.0	0.0	0.0	17.24	17.24

Any report having not been signed by authorized approver, or having been altered without authorization, or having not been stamped by the "Dedicated Testing/Inspection Stamp" is deemed to be invalid. Copying or excerpting portion of, or altering the content of the report is not permitted without the written authorization of AGC. The test results presented in the report apply only to the tested sample. Any objections to report issued by AGC should be submitted to AGC within 15days after the issuance of the test report. Further enquiry of validity or verification of the test report should be addressed to AGC by agc01@agccert.com.

## 5.2. Tissue Dielectric Parameters for Head and Body Phantoms

The head and body tissue dielectric parameters recommended by the IEEE Std. 1528 have been incorporated in the following table.

Target Frequency (MHz)	head		body	
	$\epsilon_r$	$\sigma$ (S/m)	$\epsilon_r$	$\sigma$ (S/m)
300	45.3	0.87	45.3	0.87
450	43.5	0.87	43.5	0.87
<b>750</b>	<b>41.9</b>	<b>0.89</b>	<b>41.9</b>	<b>0.89</b>
<b>835</b>	<b>41.5</b>	<b>0.90</b>	<b>41.5</b>	<b>0.90</b>
900	41.5	0.97	41.5	0.97
915	41.5	1.01	41.5	1.01
1450	40.5	1.20	40.5	1.20
1610	40.3	1.29	40.3	1.29
<b>1750</b>	<b>40.1</b>	<b>1.37</b>	<b>40.1</b>	<b>1.37</b>
<b>1800 – 2000</b>	<b>40.0</b>	<b>1.40</b>	<b>40.0</b>	<b>1.40</b>
2300	39.5	1.67	39.5	1.67
<b>2450</b>	<b>39.2</b>	<b>1.80</b>	<b>39.2</b>	<b>1.80</b>
2600	39.0	1.96	39.0	1.96
3000	38.5	2.40	38.5	2.40
<b>5200</b>	<b>36.0</b>	<b>4.66</b>	<b>36.0</b>	<b>4.66</b>
5300	<b>35.9</b>	<b>4.76</b>	<b>35.9</b>	<b>4.76</b>
5600	<b>35.5</b>	<b>5.07</b>	<b>35.5</b>	<b>5.07</b>
<b>5800</b>	<b>35.3</b>	<b>5.27</b>	<b>35.3</b>	<b>5.27</b>

( $\epsilon_r$  = relative permittivity,  $\sigma$  = conductivity and  $\rho = 1000 \text{ kg/m}^3$ )

Any report having not been signed by authorized approver, or having been altered without authorization, or having not been stamped by the “Dedicated Testing/Inspection Stamp” is deemed to be invalid. Copying or excerpting portion of, or altering the content of the report is not permitted without the written authorization of AGC. The test results presented in the report apply only to the tested sample. Any objections to report issued by AGC should be submitted to AGC within 15days after the issuance of the test report. Further enquiry of validity or verification of the test report should be addressed to AGC by agc01@agccert.com.

### 5.3. Tissue Calibration Result

The dielectric parameters of the liquids were verified prior to the SAR evaluation using SATIMO Dielectric Probe Kit and R&S Network Analyzer ZVL6.

Tissue Stimulant Measurement for 750MHz					
	Fr. (MHz)	Dielectric Parameters ( $\pm 10\%$ )		Tissue Temp [°C]	Test time
		$\epsilon_r$ 41.9 (37.71-46.09)	$\delta$ [s/m] 0.89(0.801-0.979)		
Head	673	44.34	0.81	20.5	Dec. 09, 2023
	683	43.66	0.81		
	688	42.32	0.82		
	704	41.68	0.82		
	707.5	41.22	0.83		
	711	40.91	0.85		
	750	40.13	0.87		
	782	39.61	0.89		
	793	38.43	0.91		

Tissue Stimulant Measurement for 835MHz					
	Fr. (MHz)	Dielectric Parameters ( $\pm 10\%$ )		Tissue Temp [°C]	Test time
		$\epsilon_r$ 41.5 (37.35-45.65)	$\delta$ [s/m] 0.90(0.81-0.99)		
Head	826.4	43.62	0.88	21.7	Dec. 05, 2023
	829	42.35	0.89		
	835	41.28	0.91		
	836.4	40.72	0.92		
	836.5	40.72	0.92		
	846.6	39.67	0.94		
	844	39.10	0.95		

Tissue Stimulant Measurement for 1750MHz					
	Fr. (MHz)	Dielectric Parameters ( $\pm 10\%$ )		Tissue Temp [°C]	Test time
		$\epsilon_r$ 40.1 (36.09-44.11)	$\delta$ [s/m]1.37(1.233-1.507)		
Head	1712.4	42.19	1.31	21.2	Dec. 20, 2023
	1720	41.32	1.33		
	1732.4	40.92	1.36		
	1732.5	40.92	1.36		
	1745	40.37	1.38		
	1750	39.45	1.41		
	1752.6	38.92	1.42		
	1755	38.16	1.44		
	1770	37.86	1.46		

Any report having not been signed by authorized approver, or having been altered without authorization, or having not been stamped by the "Dedicated Testing/Inspection Stamp" is deemed to be invalid. Copying or excerpting portion of, or altering the content of the report is not permitted without the written authorization of AGC. The test results presented in the report apply only to the tested sample. Any objections to report issued by AGC should be submitted to AGC within 15days after the issuance of the test report. Further enquiry of validity or verification of the test report should be addressed to AGC by agc01@agccert.com.

Tissue Stimulant Measurement for 1900MHz					
Head	Fr. (MHz)	Dielectric Parameters ( $\pm 10\%$ )		Tissue Temp [°C]	Test time
		$\epsilon_r$ 40.00(36.00-44.00)	$\delta$ [s/m]1.40(1.26-1.54)		
	1852.4	42.03	1.35	20.3	Dec. 01, 2023
	1860	41.27	1.38		
	1880	40.36	1.40		
	1900	39.09	1.42		
	1907.6	38.79	1.44		

Tissue Stimulant Measurement for 2450MHz					
Head	Fr. (MHz)	Dielectric Parameters ( $\pm 10\%$ )		Tissue Temp [°C]	Test time
		$\epsilon_r$ 39.2(35.28-43.12)	$\delta$ [s/m]1.80(1.62-1.98)		
	2437	40.36	1.79	20.8	Dec. 22, 2023
	2450	39.47	1.81		

Tissue Stimulant Measurement for 5200MHz					
Head	Fr. (MHz)	Dielectric Parameters ( $\pm 10\%$ )		Tissue Temp [°C]	Test time
		$\epsilon_r$ 36.0(32.4-39.6)	$\delta$ [s/m]4.66(4.194 -5.126)		
	5200	36.21	4.50	19.8	Dec. 13, 2023

Tissue Stimulant Measurement for 5300MHz					
Head	Fr. (MHz)	Dielectric Parameters ( $\pm 5\%$ )		Tissue Temp [°C]	Test time
		$\epsilon_r$ 35.9(34.105-37.695)	$\delta$ [s/m]4.76(4.522-4.998)		
	5300	36.59	4.91	21.0	Dec. 14, 2023

Tissue Stimulant Measurement for 5600MHz					
Head	Fr. (MHz)	Dielectric Parameters ( $\pm 5\%$ )		Tissue Temp [°C]	Test time
		$\epsilon_r$ 35.5(33.725-37.275)	$\delta$ [s/m]5.07(4.8165-5.3235)		
	5600	36.55	5.14	21.0	Dec. 15, 2023

Tissue Stimulant Measurement for 5800MHz					
Head	Fr. (MHz)	Dielectric Parameters ( $\pm 10\%$ )		Tissue Temp [°C]	Test time
		$\epsilon_r$ 35.3 (31.77-38.83)	$\delta$ [s/m]5.27 (4.743-5.797)		
	5785	36.46	5.22	21.3	Dec. 16, 2023
	5800	35.23	5.25		

Any report having not been signed by authorized approver, or having been altered without authorization, or having not been stamped by the "Dedicated Testing/Inspection Stamp" is deemed to be invalid. Copying or excerpting portion of, or altering the content of the report is not permitted without the written authorization of AGC. The test results presented in the report apply only to the tested sample. Any objections to report issued by AGC should be submitted to AGC within 15days after the issuance of the test report. Further enquiry of validity or verification of the test report should be addressed to AGC by agc01@agccert.com.

## 6. SAR SYSTEM CHECK PROCEDURE

### 6.1. SAR System Check Procedures

SAR system check is required to confirm measurement accuracy, according to the tissue dielectric media, probe calibration points and other system operating parameters required for measuring the SAR of a test device. The system verification must be performed for each frequency band and within the valid range of each probe calibration point required for testing the device. The same SAR probe(s) and tissue-equivalent media combinations used with each specific SAR system for system verification must be used for device testing. When multiple probe calibration points are required to cover substantially large transmission bands, independent system verifications are required for each probe calibration point. A system verification must be performed before each series of SAR measurements using the same probe calibration point and tissue-equivalent medium. Additional system verification should be considered according to the conditions of the tissue-equivalent medium and measured tissue dielectric parameters, typically every three to four days when the liquid parameters are remeasured or sooner when marginal liquid parameters are used at the beginning of a series of measurements.

Each SATIMO system is equipped with one or more system check kits. These units, together with the predefined measurement procedures within the SATIMO software, enable the user to conduct the system check and system validation. System kit includes a dipole, and dipole device holder.

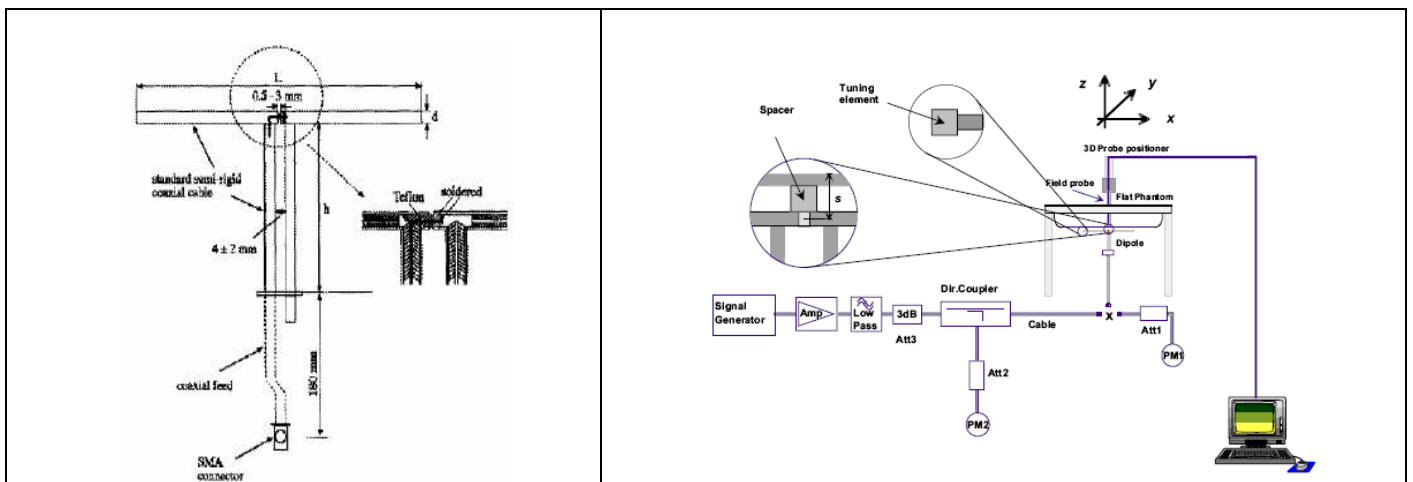

The system check verifies that the system operates within its specifications. It's performed daily or before every SAR measurement. The system check uses normal SAR measurement in the flat section of the phantom with a matched dipole at a specified distance. The system check setup is shown as below.



Any report having not been signed by authorized approver, or having been altered without authorization, or having not been stamped by the "Dedicated Testing/Inspection Stamp" is deemed to be invalid. Copying or excerpting portion of, or altering the content of the report is not permitted without the written authorization of AGC. The test results presented in the report apply only to the tested sample. Any objections to report issued by AGC should be submitted to AGC within 15 days after the issuance of the test report. Further enquiry of validity or verification of the test report should be addressed to AGC by [agc01@agccert.com](mailto:agc01@agccert.com).

## 6.2. SAR System Check

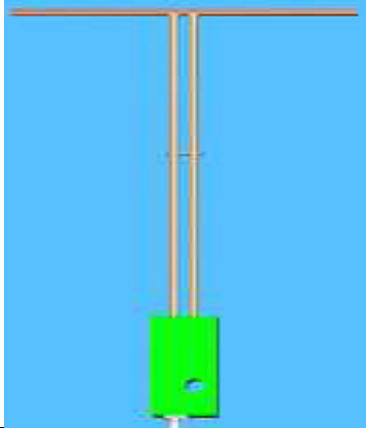
### 6.2.1. Dipoles

	<p>The dipoles are based on the IEEE-1528 standard, and are complied with mechanical and electrical specifications in line with the requirements of IEEE. the table below provides details for the mechanical and electrical Specifications for the dipoles.</p>
	<p>The dipole is based on the IEEE-1528 standard, and is complied with mechanical and electrical specifications in line with the requirements of IEEE. The table below provides details for the mechanical and electrical specifications for the wave guide.</p>

Frequency	L (mm)	h (mm)	d (mm)
750MHz	176	100	6.35
835MHz	161.0	89.8	3.6
1800MHz	71.6	41.7	3.6
1900MHz	68	39.5	3.6
2450MHz	51.5	30.4	3.6
5000MHz	20.6	40.3	3.6

Any report having not been signed by authorized approver, or having been altered without authorization, or having not been stamped by the “Dedicated Testing/Inspection Stamp” is deemed to be invalid. Copying or excerpting portion of, or altering the content of the report is not permitted without the written authorization of AGC. The test results presented in the report apply only to the tested sample. Any objections to report issued by AGC should be submitted to AGC within 15days after the issuance of the test report. Further enquiry of validity or verification of the test report should be addressed to AGC by agc01@agccert.com.

### 6.2.2. System Check Result

System Performance Check at 750MHz&835MHz &1800MHz &1900MHz &2450MHz& 5200-5800MHz for Head								
Validation Kit: SN 22/16 DIP 0G750-417& SN 15/16 DIP 0G835-399& SN 46/11 DIP 1G800-186& SN 29/15 DIP 1G900-389& SN 29/15 DIP 2G450-393& SN 17/22 DIP 5G000-671								
Frequency [MHz]	Target Value(W/kg)		Reference Result ( $\pm 10\%$ )		Tested Value(W/kg)		Tissue Temp. [°C]	Test time
	1g	10g	1g	10g	1g	10g		
750	8.33	5.44	7.497-9.163	4.896-5.984	8.95	5.64	20.5	Dec. 09, 2023
835	9.67	6.14	8.703-10.637	5.526-6.754	9.61	6.14	21.7	Dec. 05, 2023
1800	37.76	19.60	33.984-41.536	17.640-21.560	40.62	20.57	21.2	Dec. 20, 2023
1900	41.26	20.86	37.134-45.386	18.774-22.946	42.33	20.56	20.3	Dec. 01, 2023
2450	54.32	24.25	48.888-59.752	21.825-26.675	52.89	23.69	20.8	Dec. 22, 2023
5200	73.43	21.83	66.087-80.773	19.647-24.013	74.22	21.20	19.8	Dec. 13, 2023
5200	73.43	21.83	66.087-80.773	19.647-24.013	77.79	22.41	21.0	Dec. 14, 2023
5600	78.20	24.12	70.380-86.02	21.708-26.532	82.33	23.29	21.0	Dec. 15, 2023
5800	75.69	22.44	68.121-83.259	20.196-24.684	80.65	23.23	21.3	Dec. 16, 2023

Note:

(1) We use a CW signal of 18dBm for system check, and then all SAR value are normalized to 1W forward power. The result must be within  $\pm 10\%$  of target value.

Any report having not been signed by authorized approver, or having been altered without authorization, or having not been stamped by the "Dedicated Testing/Inspection Stamp" is deemed to be invalid. Copying or excerpting portion of, or altering the content of the report is not permitted without the written authorization of AGC. The test results presented in the report apply only to the tested sample. Any objections to report issued by AGC should be submitted to AGC within 15days after the issuance of the test report. Further enquiry of validity or verification of the test report should be addressed to AGC by agc01@agccert.com.

## 7. EUT TEST POSITION

This EUT was tested in **Body back, Body front and 4 edges.**

### 7.1. Test Position

- (1) To position the EUT parallel to the phantom surface.
- (2) To adjust the EUT parallel to the flat phantom.
- (3) To adjust the distance between the EUT surface and the flat phantom to **0mm**.

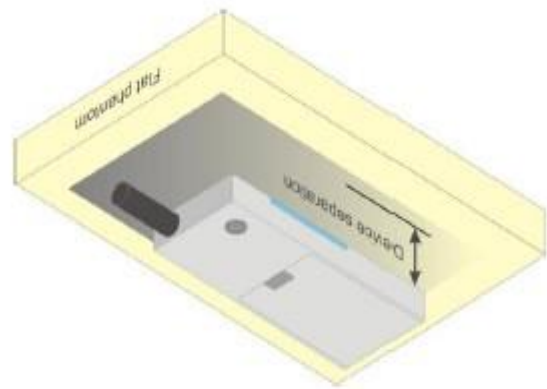
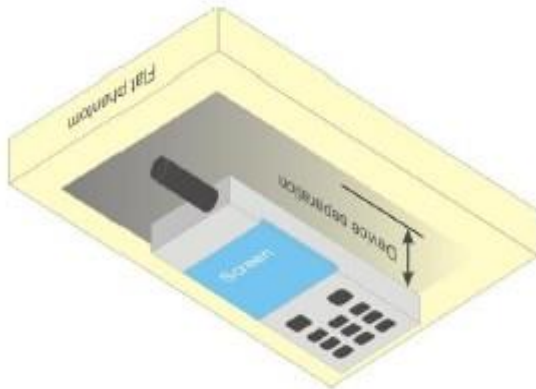

Any report having not been signed by authorized approver, or having been altered without authorization, or having not been stamped by the “Dedicated Testing/Inspection Stamp” is deemed to be invalid. Copying or excerpting portion of, or altering the content of the report is not permitted without the written authorization of AGC. The test results presented in the report apply only to the tested sample. Any objections to report issued by AGC should be submitted to AGC within 15days after the issuance of the test report. Further enquiry of validity or verification of the test report should be addressed to AGC by [agc01@agccert.com](mailto:agc01@agccert.com).



## 8. SAR EXPOSURE LIMITS

### Limits for General Population/Uncontrolled Exposure (W/kg)

Type Exposure	Uncontrolled Environment Limit (W/kg)
Spatial Peak SAR (1g cube tissue for brain or body)	1.60
Spatial Average SAR (Whole body)	0.08
Spatial Peak SAR (Limbs)	4.0

Any report having not been signed by authorized approver, or having been altered without authorization, or having not been stamped by the "Dedicated Testing/Inspection Stamp" is deemed to be invalid. Copying or excerpting portion of, or altering the content of the report is not permitted without the written authorization of AGC. The test results presented in the report apply only to the tested sample. Any objections to report issued by AGC should be submitted to AGC within 15days after the issuance of the test report. Further enquiry of validity or verification of the test report should be addressed to AGC by [agc01@agccert.com](mailto:agc01@agccert.com).

## 9. TEST FACILITY

<b>Test Site</b>	Attestation of Global Compliance (Shenzhen) Co., Ltd
<b>Location</b>	1-2/F, Building 19, Junfeng Industrial Park, Chongqing Road, Heping Community, Fuhai Street, Bao'an District, Shenzhen, Guangdong, China
<b>Designation Number</b>	CN1259
<b>FCC Test Firm Registration Number</b>	975832
<b>A2LA Cert. No.</b>	5054.02
<b>Description</b>	Attestation of Global Compliance(Shenzhen) Co., Ltd is accredited by A2LA

Any report having not been signed by authorized approver, or having been altered without authorization, or having not been stamped by the "Dedicated Testing/Inspection Stamp" is deemed to be invalid. Copying or excerpting portion of, or altering the content of the report is not permitted without the written authorization of AGC. The test results presented in the report apply only to the tested sample. Any objections to report issued by AGC should be submitted to AGC within 15days after the issuance of the test report. Further enquiry of validity or verification of the test report should be addressed to AGC by [agc01@agccert.com](mailto:agc01@agccert.com).

## 10. TEST EQUIPMENT LIST

Equipment description	Manufacturer/ Model	Identification No.	Software version	Current calibration date	Next calibration date
SAR Probe	MVG	2023-EPGO-414	N/A	May 31, 2023	May 30, 2024
Phantom	SATIMO	SN_4511_SAM90	N/A	Validated. No cal required.	Validated. No cal required.
Liquid	SATIMO	N/A	N/A	Validated. No cal required.	Validated. No cal required.
Comm Tester	Agilent-8960	GB46310822	A.13.07	Jun. 03, 2023	Jun. 02, 2024
Comm Tester	R&S- CMW500	121209	V3.7.40	Jun. 01, 2023	May 31, 2024
Multimeter	Keithley 2000	1350784	N/A	Jun. 02, 2023	Jun. 01, 2024
SAR Software	SATIMO-OpenSAR	N/A	OpenSAR V4_02_32	N/A	N/A
Dipole	SATIMO SID750	SN 22/16 DIP 0G750-417	N/A-	Apr. 28,2022	Apr. 27,2025
Dipole	SATIMO SID835	SN 15/16 DIP 0G835-399	N/A	Apr. 28,2022	Apr. 27,2025
Dipole	SATIMO SID1800	SN 46/11 DIP 1G800-186	N/A	Apr. 28,2022	Apr. 27,2025
Dipole	SATIMO SID1900	SN 29/15 DIP 1G900-389	N/A	Apr. 28,2022	Apr. 27,2025
Dipole	SATIMO SID2450	SN 29/15 DIP 2G450-393	N/A	Apr. 28,2022	Apr. 27,2025
Dipole	SID5000	SN 17/22 DIP 5G000-671	N/A	Apr. 28,2022	Apr. 27, 2025
Signal Generator	Agilent-E4438C	US41461365	V5.03	Jun. 01, 2023	May 31, 2024
Vector Analyzer	Agilent / E4440A	MY44303916	N/A	Jun. 01, 2023	May 31, 2024
Network Analyzer	Rhode & Schwarz ZVL6	SN101443	3.2	Sep. 21, 2023	Sep. 20, 2024
Attenuator	Warison /WATT-6SR1211	S/N:WRJ34AYM2F1	N/A	June 07, 2023	June 06, 2024
Attenuator	Mini-circuits / VAT-10+	31405	N/A	June 07, 2023	June 06, 2024
Amplifier	AS0104-55_55	1004793	N/A	N/A	N/A
Directional Couple	Werlatone/ C5571-10	SN99463	N/A	Mar. 10, 2022	Mar. 09, 2024
Directional Couple	Werlatone/ C6026-10	SN99482	N/A	Mar. 10, 2022	Mar. 09, 2024
Power Sensor	NRP-Z21	1137.6000.02	N/A	Sep. 05, 2023	Sep. 04, 2024
Power Sensor	NRP-Z23	100323	N/A	Feb. 15, 2023	Feb. 14, 2024
Power Viewer	R&S	V2.3.1.0	N/A	N/A	N/A
Calibration standard parts for network sub - port	R&S/ ZV-Z132	N/A	V2.3.1.0	Nov. 11, 2023	Nov. 10, 2024

Note: Per KDB 865664 Dipole SAR Validation, AGC Lab has adopted 3 years calibration intervals. On annual basis, every measurement dipole has been evaluated and is in compliance with the following criteria:

1. There is no physical damage on the dipole;
2. System validation with specific dipole is within 10% of calibrated value;
3. Return-loss is within 20% of calibrated measurement;
4. Impedance is within 5Ω of calibrated measurement.

Any report having not been signed by authorized approver, or having been altered without authorization, or having not been stamped by the “Dedicated Testing/Inspection Stamp” is deemed to be invalid. Copying or excerpting portion of, or altering the content of the report is not permitted without the written authorization of AGC. The test results presented in the report apply only to the tested sample. Any objections to report issued by AGC should be submitted to AGC within 15days after the issuance of the test report. Further enquiry of validity or verification of the test report should be addressed to AGC by agc01@agccert.com.

## 11. MEASUREMENT UNCERTAINTY

SATIMO Uncertainty- 2023-EPGO-414 Measurement uncertainty for DUT averaged over 1 gram / 10 gram.									
Uncertainty Component	Sec.	Tol (+-%)	Prob. Dist.	Div.	Ci (1g)	Ci (10g)	1g Ui (+-%)	10g Ui (+-%)	vi
<b>Measurement System</b>									
Probe calibration	E.2.1	7.000	N	1	1	1	7.000	7.000	∞
Axial Isotropy	E.2.2	1.695	R	1.732	0.707	0.707	0.692	0.692	∞
Hemispherical Isotropy	E.2.2	1.695	R	1.732	0.707	0.707	0.692	0.692	∞
Boundary effect	E.2.3	1.000	R	1.732	1	1	0.577	0.577	∞
Linearity	E.2.4	2.250	R	1.732	1	1	1.299	1.299	∞
System detection limits	E.2.4	1.000	R	1.732	1	1	0.577	0.577	∞
Modulation response	E.2.5	3.000	R	1.732	1	1	1.732	1.732	∞
Readout Electronics	E.2.6	0.021	N	1	1	1	0.021	0.021	∞
Response Time	E.2.7	0.000	R	1.732	1	1	0.000	0.000	∞
Integration Time	E.2.8	1.400	R	1.732	1	1	0.808	0.808	∞
RF ambient conditions-Noise	E.6.1	3.000	R	1.732	1	1	1.732	1.732	∞
RF ambient conditions-reflections	E.6.1	3.000	R	1.732	1	1	1.732	1.732	∞
Probe positioner mechanical tolerance	E.6.2	1.400	R	1.732	1	1	0.808	0.808	∞
Probe positioning with respect to phantom shell	E.6.3	1.400	R	1.732	1	1	0.808	0.808	∞
Extrapolation, interpolation, and integrations algorithms for max. SAR evaluation	E.5	2.300	R	1.732	1	1	1.328	1.328	∞
<b>Test sample Related</b>									
Test sample positioning	E.4.2	2.6	N	1	1	1	2.60	2.60	∞
Device holder uncertainty	E.4.1	3	N	1	1	1	3.00	3.00	∞
Output power variation—SAR drift measurement	E.2.9	5	R	1.732	1	1	2.89	2.89	∞
SAR scaling	E.6.5	5	R	1.732	1	1	2.89	2.89	∞
<b>Phantom and tissue parameters</b>									
Phantom shell uncertainty—shape, thickness, and permittivity	E.3.1	4	R	1.732	1	1	2.309	2.309	∞
Uncertainty in SAR correction for deviations in permittivity and conductivity	E.3.2	1.9	N	1	1	0.84	1.900	1.596	∞
Liquid conductivity measurement	E.3.3	4	N	1	0.78	0.71	3.120	2.840	M
Liquid permittivity measurement	E.3.3	5	N	1	0.23	0.26	1.150	1.300	M
Liquid conductivity—temperature uncertainty	E.3.4	2.5	R	1.732	0.78	0.71	1.126	1.025	∞
Liquid permittivity—temperature uncertainty	E.3.4	2.5	R	1.732	0.23	0.26	0.332	0.375	∞
Combined Standard Uncertainty			RSS				10.616	10.432	
Expanded Uncertainty (95% Confidence interval)			K=2				21.232	20.865	

Any report having not been signed by authorized approver, or having been altered without authorization, or having not been stamped by the “Dedicated Testing/Inspection Stamp” is deemed to be invalid. Copying or excerpting portion of, or altering the content of the report is not permitted without the written authorization of AGC. The test results presented in the report apply only to the tested sample. Any objections to report issued by AGC should be submitted to AGC within 15days after the issuance of the test report. Further enquiry of validity or verification of the test report should be addressed to AGC by agc01@agccert.com.

SATIMO Uncertainty- 2023-EPGO-414									
System Validation uncertainty for DUT averaged over 1 gram / 10 gram.									
Uncertainty Component	Sec.	Tol (+- %)	Prob. Dist.	Div.	Ci (1g)	Ci (10g)	1g Ui (+-%)	10g Ui (+-%)	vi
<b>Measurement System</b>									
Probe calibration	E.2.1	7.000	N	1	1	1	7.000	7.000	∞
Axial Isotropy	E.2.2	1.695	R	1.732	1.000	1.000	0.979	0.979	∞
Hemispherical Isotropy	E.2.2	1.695	R	1.732	0.000	0.000	0.000	0.000	∞
Boundary effect	E.2.3	1.000	R	1.732	1.000	1.000	0.577	0.577	∞
Linearity	E.2.4	2.250	R	1.732	1.000	1.000	1.299	1.299	∞
System detection limits	E.2.4	1.000	R	1.732	1.000	1.000	0.577	0.577	∞
Modulation response	E.2.5	3.000	R	1.732	0.000	0.000	0.000	0.000	∞
Readout Electronics	E.2.6	0.021	N	1.000	1.000	1.000	0.021	0.021	∞
Response Time	E.2.7	0.000	R	1.732	0.000	0.000	0.000	0.000	∞
Integration Time	E.2.8	1.400	R	1.732	0.000	0.000	0.000	0.000	∞
RF ambient conditions-Noise	E.6.1	3.000	R	1.732	1.000	1.000	1.732	1.732	∞
RF ambient conditions-reflections	E.6.1	3.000	R	1.732	1.000	1.000	1.732	1.732	∞
Probe positioner mechanical tolerance	E.6.2	1.400	R	1.732	1.000	1.000	0.808	0.808	∞
Probe positioning with respect to phantom shell	E.6.3	1.400	R	1.732	1.000	1.000	0.808	0.808	∞
Extrapolation, interpolation, and integrations algorithms for max. SAR evaluation	E.5	2.300	R	1.732	1.000	1.000	1.328	1.328	∞
<b>System validation source</b>									
Deviation of experimental dipole from numerical dipole	E.6.4	5	N	1	1	1	5	5	∞
Input power and SAR drift measurement	8,6.6.4	5	R	1.732	1	1	2.887	2.887	∞
Dipole axis to liquid distance	8,E.6.6	2	R	1.732	1	1	1.155	1.155	∞
<b>Phantom and set-up</b>									
Phantom shell uncertainty—shape, thickness, and permittivity	E.3.1	4	R	1.732	1	1	2.309	2.309	∞
Uncertainty in SAR correction for deviations in permittivity and conductivity	E.3.2	1.9	N	1	1	0.84	1.9	1.596	∞
Liquid conductivity (temperature uncertainty)	E.3.3	4	N	1	0.78	0.71	3.12	2.84	∞
Liquid conductivity (measured)	E.3.3	5	N	1	0.23	0.26	1.15	1.3	M
Liquid permittivity (temperature uncertainty)	E.3.4	2.5	R	1.732	0.78	0.71	1.126	1.025	∞
Liquid permittivity (measured)	E.3.4	2.5	R	1.732	0.23	0.26	0.332	0.375	M
Combined Standard Uncertainty			RSS				10.572	10.387	
Expanded Uncertainty (95% Confidence interval)			K=2				21.143	20.775	

Any report having not been signed by authorized approver, or having been altered without authorization, or having not been stamped by the “Dedicated Testing/Inspection Stamp” is deemed to be invalid. Copying or excerpting portion of, or altering the content of the report is not permitted without the written authorization of AGC. The test results presented in the report apply only to the tested sample. Any objections to report issued by AGC should be submitted to AGC within 15days after the issuance of the test report. Further enquiry of validity or verification of the test report should be addressed to AGC by agc01@agccert.com.

SATIMO Uncertainty- 2023-EPGO-414									
System Check uncertainty for DUT averaged over 1 gram / 10 gram.									
Uncertainty Component	Sec.	Tol (+-%)	Prob. Dist.	Div.	Ci (1g)	Ci (10g)	1g Ui (+-%)	10g Ui (+-%)	vi
<b>Measurement System</b>									
Probe calibration drift	E.2.1.3	0.5	N	1	1	1	0.5	0.5	∞
Axial Isotropy	E.2.2	1.695	R	$\sqrt{3}$	0	0	0	0	∞
Hemispherical Isotropy	E.2.2	1.695	R	$\sqrt{3}$	0	0	0	0	∞
Boundary effect	E.2.3	1.000	R	$\sqrt{3}$	0	0	0	0	∞
Linearity	E.2.4	2.250	R	$\sqrt{3}$	0	0	0	0	∞
System detection limits	E.2.4	1	R	$\sqrt{3}$	0	0	0	0	∞
Modulation response	E.2.5	3	R	$\sqrt{3}$	0	0	0	0	∞
Readout Electronics	E.2.6	0.021	N	$\sqrt{3}$	0	0	0	0	∞
Response Time	E.2.7	0	R	$\sqrt{3}$	0	0	0	0	∞
Integration Time	E.2.8	1.4	R	$\sqrt{3}$	0	0	0	0	∞
RF ambient conditions-Noise	E.6.1	3	R	$\sqrt{3}$	0	0	0	0	∞
RF ambient conditions-reflections	E.6.1	3	R	$\sqrt{3}$	0	0	0	0	∞
Probe positioner mechanical tolerance	E.6.2	1.4	R	$\sqrt{3}$	1	1	0.81	0.81	∞
Probe positioning with respect to phantom shell	E.6.3	1.4	R	$\sqrt{3}$	1	1	0.81	0.81	∞
Extrapolation, interpolation, and integrations algorithms for max. SAR evaluation	E.5	2.3	R	$\sqrt{3}$	0	0	0	0.00	∞
<b>System check source (dipole)</b>									
Deviation of experimental dipoles	E.6.4	2	N	1	1	1	2	2	∞
Input power and SAR drift measurement	8,6.6.4	5	R	$\sqrt{3}$	1	1	2.89	2.89	∞
Dipole axis to liquid distance	8,E.6.6	2	R	$\sqrt{3}$	1	1	1.15	1.15	∞
<b>Phantom and tissue parameters</b>									
Phantom shell uncertainty—shape, thickness, and permittivity	E.3.1	4	R	$\sqrt{3}$	1	1	2.31	2.31	∞
Uncertainty in SAR correction for deviations in permittivity and conductivity	E.3.2	1.9	N	1.000	1	0.84	1.90	1.60	∞
Liquid conductivity measurement	E.3.3	4	N	1.000	0.78	0.71	3.12	2.84	∞
Liquid permittivity measurement	E.3.3	5	N	1.000	0.23	0.26	1.15	1.30	M
Liquid conductivity—temperature uncertainty	E.3.4	2.5	R	$\sqrt{3}$	0.78	0.71	1.13	1.02	∞
Liquid permittivity—temperature uncertainty	E.3.4	2.5	R	$\sqrt{3}$	0.23	0.26	0.33	0.38	M
Combined Standard Uncertainty			RSS				5.562	5.203	
Expanded Uncertainty (95% Confidence interval)			K=2				11.124	10.406	

Any report having not been signed by authorized approver, or having been altered without authorization, or having not been stamped by the “Dedicated Testing/Inspection Stamp” is deemed to be invalid. Copying or excerpting portion of, or altering the content of the report is not permitted without the written authorization of AGC. The test results presented in the report apply only to the tested sample. Any objections to report issued by AGC should be submitted to AGC within 15days after the issuance of the test report. Further enquiry of validity or verification of the test report should be addressed to AGC by agc01@agccert.com.

## 12. CONDUCTED POWER MEASUREMENT

### UMTS BAND

#### HSDPA Setup Configuration:

- The EUT was connected to Base Station Agilent-8960 referred to the Setup Configuration.
- The RF path losses were compensated into the measurements.
- A call was established between EUT and Based Station with following setting:
  - (1) Set Gain Factors( $\beta_c$  and  $\beta_d$ ) parameters set according to each
  - (2) Set RMC 12.2Kbps+HSDPA mode.
  - (3) Set Cell Power=-86dBm
  - (4) Set HS-DSCH Configuration Type to FRC (H-set 1, QPSK)
  - (5) Select HSDPA Uplink Parameters
  - (6) Set Delta ACK, Delta NACK and Delta CQI=8
  - (7) Set Ack - Nack Repetition Factor to 3
  - (8) Set CQI Feedback Cycle (k) to 4ms
  - (9) Set CQI Repetition Factor to 2
  - (10) Power Ctrl Mode=All Up bits
- The transmitted maximum output power was recorded.

Table C.10.2.4:  $\beta$  values for transmitter characteristics tests with HS-DPCCH

Sub-test	$\beta_c$ (Note5)	$\beta_d$	$\beta_d$ (SF)	$\beta_c/\beta_d$	$\beta_{HS}$ (Note1, Note 2)	CM (dB) (Note 3)	MPR (dB) (Note 3)
1	2/15	15/15	64	2/15	4/15	0.0	0.0
2	12/15(Note 4)	15/15(Note 4)	64	12/15(Note 4)	24/15	1.0	0.0
3	15/15	8/15	64	15/8	30/15	1.5	0.5
4	15/15	4/15	64	15/4	30/15	1.5	0.5

Note 1:  $\Delta ACK$ ,  $\Delta NACK$  and  $\Delta CQI = 30/15$  with  $\beta_{hs} = 30/15 * \beta_c$ .

Note 2: For the HS-DPCCH power mask requirement test in clause 5.2C, 5.7A, and the Error Vector Magnitude (EVM) with HS-DPCCH test in clause 5.13.1A, and HSDPA EVM with phase discontinuity in clause 5.13.1AA,  $\Delta ACK$  and  $\Delta NACK = 30/15$  with  $\beta_{hs} = 30/15 * \beta_c$ , and  $\Delta CQI = 24/15$  with  $\beta_{hs} = 24/15 * \beta_c$ .

Note 3: CM = 1 for  $\beta_c/\beta_d = 12/15$ ,  $hs/c = 24/15$ . For all other combinations of DPDCH, DPCCH and HS-DPCCH the MPR is based on the relative CM difference. This is applicable for only UEs that support HSDPA in release 6 and later releases.

Note 4: For subtest 2 the  $c/d$  ratio of 12/15 for the TFC during the measurement period (TF1, TF0) is achieved by setting the signalled gain factors for the reference TFC (TF1, TF1) to  $c = 11/15$  and  $d = 15/15$ .

**HSUPA Setup Configuration:**

- The EUT was connected to Base Station Agilent-8960 referred to the Setup Configuration.
- The RF path losses were compensated into the measurements.
- A call was established between EUT and Base Station with following setting \* :
  - (1) Call Configs = 5.2B, 5.9B, 5.10B, and 5.13.2B with QPSK
  - (2) Set the Gain Factors ( $\beta_c$  and  $\beta_d$ ) and parameters (AG Index) were set according to each specific sub-test in the following table, C11.1.3, quoted from the TS 34.121
  - (3) Set Cell Power = -86 dBm
  - (4) Set Channel Type = 12.2k + HSPA
  - (5) Set UE Target Power
  - (6) Power Ctrl Mode= Alternating bits
  - (7) Set and observe the E-TFCI
  - (8) Confirm that E-TFCI is equal to the target E-TFCI of 75 for sub-test 1, and other subtest's E-TFCI
- The transmitted maximum output power was recorded.

Table C.11.1.3:  $\beta$  values for transmitter characteristics tests with HS-DPCCH and E-DCH

Sub-test	$\beta_c$	$\beta_d$	$\beta_d$ (SF)	$\beta_c/\beta_d$	$\beta_{HS}$ (Note 1)	$\beta_{ec}$	$\beta_{ed}$ (Note 4) (Note 5)	$\beta_{ed}$ (SF)	$\beta_{ed}$ (Codes)	CM (dB) (Note 2)	MPR (dB) (Note 2) (Note 6)	AG Index (Note 5)	E-TF CI
1	11/15 (Note 3)	15/15 (Note 3)	64	11/15 (Note 3)	22/15	209/225	1309/225	4	1	1.0	0.0	20	75
2	6/15	15/15	64	6/15	12/15	12/15	94/75	4	1	3.0	2.0	12	67
3	15/15	9/15	64	15/9	30/15	30/15	$\beta_{ed1}$ : 47/15 $\beta_{ed2}$ : 47/15	4 4	2	2.0	1.0	15	92
4	2/15	15/15	64	2/15	4/15	2/15	56/75	4	1	3.0	2.0	17	71
5	15/15	0	-	-	5/15	5/15	47/15	4	1	1.0	0.0	12	67

Note 1: For sub-test 1 to 4,  $\Delta ACK$ ,  $\Delta NACK$  and  $\Delta CQI = 30/15$  with  $\beta_{hs} = 30/15 * \beta_c$ . For sub-test 5,  $\Delta ACK$ ,  $\Delta NACK$  and  $\Delta CQI = 5/15$  with  $\beta_{hs} = 5/15 * \beta_c$ .

Note 2: CM = 1 for  $\beta_c/\beta_d = 12/15$ ,  $hs/c = 24/15$ . For all other combinations of DPDCH, DPCCH, HS-DPCCH, E-DPDCH and E-DPCCH the MPR is based on the relative CM difference.

Note 3: For subtest 1 the  $c/d$  ratio of 11/15 for the TFC during the measurement period (TF1, TF0) is achieved by setting the signalled gain factors for the reference TFC (TF1, TF1) to  $c = 10/15$  and  $d = 15/15$ .

Note 4: In case of testing by UE using E-DPDCH Physical Layer category 1, Sub-test 3 is omitted according to TS25.306 Table 5.1g.

Note 5:  $\beta_{ed}$  cannot be set directly; it is set by Absolute Grant Value.

Note 6: For subtests 2, 3 and 4, UE may perform E-DPDCH power scaling at max power which could results in slightly smaller MPR values.



**UMTS BAND II**

Mode	Frequency (MHz)	Avg. Burst Power (dBm)
WCDMA 1900 RMC	1852.4	21.98
	1880	21.68
	1907.6	21.85
HSDPA Subtest 1	1852.4	21.02
	1880	23.68
	1907.6	20.85
HSDPA Subtest 2	1852.4	20.50
	1880	23.15
	1907.6	20.37
HSDPA Subtest 3	1852.4	20.54
	1880	23.17
	1907.6	20.31
HSDPA Subtest 4	1852.4	20.52
	1880	23.16
	1907.6	20.25
HSUPA Subtest 1	1852.4	21.14
	1880	21.72
	1907.6	21.87
HSUPA Subtest 2	1852.4	21.59
	1880	22.19
	1907.6	20.37
HSUPA Subtest 3	1852.4	20.13
	1880	22.73
	1907.6	21.82
HSUPA Subtest 4	1852.4	22.13
	1880	21.73
	1907.6	21.91
HSUPA Subtest 5	1852.4	21.08
	1880	<b>23.73</b>
	1907.6	20.88

Any report having not been signed by authorized approver, or having been altered without authorization, or having not been stamped by the "Dedicated Testing/Inspection Stamp" is deemed to be invalid. Copying or excerpting portion of, or altering the content of the report is not permitted without the written authorization of AGC. The test results presented in the report apply only to the tested sample. Any objections to report issued by AGC should be submitted to AGC within 15days after the issuance of the test report. Further enquiry of validity or verification of the test report should be addressed to AGC by agc01@agccert.com.

**UMTS BAND IV**

Mode	Frequency (MHz)	Avg. Burst Power (dBm)
WCDMA 1700 RMC	1712.4	22.31
	1732.4	22.34
	1752.6	22.21
HSDPA Subtest 1	1712.4	21.26
	1732.4	20.37
	1752.6	21.37
HSDPA Subtest 2	1712.4	20.76
	1732.4	22.85
	1752.6	<b>23.93</b>
HSDPA Subtest 3	1712.4	20.78
	1732.4	22.85
	1752.6	23.82
HSDPA Subtest 4	1712.4	22.69
	1732.4	22.91
	1752.6	23.80
HSUPA Subtest 1	1712.4	20.27
	1732.4	20.37
	1752.6	22.31
HSUPA Subtest 2	1712.4	20.76
	1732.4	20.82
	1752.6	21.73
HSUPA Subtest 3	1712.4	21.25
	1732.4	21.32
	1752.6	23.25
HSUPA Subtest 4	1712.4	20.29
	1732.4	20.29
	1752.6	22.24
HSUPA Subtest 5	1712.4	21.13
	1732.4	22.21
	1752.6	20.34

Any report having not been signed by authorized approver, or having been altered without authorization, or having not been stamped by the "Dedicated Testing/Inspection Stamp" is deemed to be invalid. Copying or excerpting portion of, or altering the content of the report is not permitted without the written authorization of AGC. The test results presented in the report apply only to the tested sample. Any objections to report issued by AGC should be submitted to AGC within 15days after the issuance of the test report. Further enquiry of validity or verification of the test report should be addressed to AGC by agc01@agccert.com.

**UMTS BAND V**

Mode	Frequency (MHz)	Avg. Burst Power (dBm)
WCDMA 850 RMC	826.4	22.91
	836.4	22.99
	846.6	<b>23.01</b>
HSDPA Subtest 1	826.4	22.92
	836.4	22.66
	846.6	21.98
HSDPA Subtest 2	826.4	22.41
	836.4	21.13
	846.6	21.46
HSDPA Subtest 3	826.4	22.44
	836.4	20.17
	846.6	21.46
HSDPA Subtest 4	826.4	22.44
	836.4	20.16
	846.6	21.53
HSUPA Subtest 1	826.4	20.98
	836.4	20.88
	846.6	20.13
HSUPA Subtest 2	826.4	21.47
	836.4	20.36
	846.6	20.64
HSUPA Subtest 3	826.4	22.02
	836.4	21.81
	846.6	21.13
HSUPA Subtest 4	826.4	21.01
	836.4	21.37
	846.6	20.21
HSUPA Subtest 5	826.4	23.00
	836.4	20.54
	846.6	22.12

Any report having not been signed by authorized approver, or having been altered without authorization, or having not been stamped by the "Dedicated Testing/Inspection Stamp" is deemed to be invalid. Copying or excerpting portion of, or altering the content of the report is not permitted without the written authorization of AGC. The test results presented in the report apply only to the tested sample. Any objections to report issued by AGC should be submitted to AGC within 15days after the issuance of the test report. Further enquiry of validity or verification of the test report should be addressed to AGC by agc01@agccert.com.

According to 3GPP 25.101 sub-clause 6.2.2 , the maximum output power is allowed to be reduced by following the table.

Table 6.1aA: UE maximum output power with HS-DPCCH and E-DCH

UE Transmit Channel Configuration	CM(db)	MPR(db)
For all combinations of ,DPDCH,DPCCH HS-DPDCH,E-DPDCH and E-DPCCH	$0 \leq CM \leq 3.5$	$MAX(CM-1,0)$
Note: CM=1 for $\beta_c/\beta_d=12/15$ , $\beta_{hs}/\beta_c=24/15$ .For all other combinations of DPDCH, DPCCH, HS-DPCCH, E-DPDCH and E-DPCCH the MPR is based on the relative CM difference.		

The device supports MPR to solve linearity issues (ACLR or SEM) due to the higher peak-to average ratios (PAR) of the HSUPA signal. This prevents saturating the full range of the TX DAC inside of device and provides a reduced power output to the RF transceiver chip according to the Cubic Metric (a function of the combinations of DPDCH, DPCCH, HS-DPCCH, E-DPDCH and E-DPCCH).

When E-DPDCH channels are present the beta gains on those channels are reduced firsts to try to get the power under the allowed limit. If the beta gains are lowered as far as possible, then a hard limiting is applied at the maximum allowed level.

The SW currently recalculates the cubic metric every time the beta gains on the E-DPDCH are reduced. The cubic metric will likely get lower each time this is done .However, there is no reported reduction of maximum output power in the HSUPA mode since the device also provides a compensation for the power back-off by increasing the gain of TX\_AGC in the transceiver (PA) device.

The end effect is that the DUT output power is identical to the case where there is no MPR in the device.

Any report having not been signed by authorized approver, or having been altered without authorization, or having not been stamped by the “Dedicated Testing/Inspection Stamp” is deemed to be invalid. Copying or excerpting portion of, or altering the content of the report is not permitted without the written authorization of AGC. The test results presented in the report apply only to the tested sample. Any objections to report issued by AGC should be submitted to AGC within 15days after the issuance of the test report. Further enquiry of validity or verification of the test report should be addressed to AGC by agc01@agccert.com.

**LTE Band**

Conducted Power of LTE Band 2(dBm)							
Bandwidth	Modulation	RB size	RB offset	Target MPR	Channel	Channel	Channel
					18607	18900	19193
1.4MHz	QPSK	1	0	0	20.17	21.04	21.05
			3	0	20.39	21.15	21.18
			5	0	20.37	21.07	20.92
		3	0	0	20.17	21.20	21.16
			2	0	20.06	21.07	20.23
			3	0	20.26	20.92	20.38
	6	0	1	20.25	20.13	20.14	
	16QAM	1	0	1	21.26	20.35	20.31
			3	1	20.65	20.54	21.03
			5	1	21.47	20.26	20.24
		3	0	1	20.06	19.91	20.29
			2	1	20.04	19.97	21.28
			3	1	20.14	20.01	20.16
	6	0	2	20.35	19.24	20.14	
Bandwidth	Modulation	RB size	RB offset	Target MPR	Channel	Channel	Channel
					18615	18900	19185
3MHz	QPSK	1	0	0	21.32	21.62	21.86
			7	0	21.29	21.30	21.38
			14	0	21.54	21.06	21.19
		8	0	1	20.38	21.43	20.69
			4	1	20.38	21.43	20.69
			7	1	20.55	21.16	20.46
	15	0	1	20.47	21.29	20.58	
	16QAM	1	0	1	20.33	21.87	21.03
			7	1	20.28	21.51	20.64
			14	1	20.43	21.02	20.49
		8	0	2	19.64	21.62	19.79
			4	2	19.51	21.74	19.88
			7	2	19.57	21.35	19.75
	15	0	2	19.62	21.47	19.61	

Any report having not been signed by authorized approver, or having been altered without authorization, or having not been stamped by the "Dedicated Testing/Inspection Stamp" is deemed to be invalid. Copying or excerpting portion of, or altering the content of the report is not permitted without the written authorization of AGC. The test results presented in the report apply only to the tested sample. Any objections to report issued by AGC should be submitted to AGC within 15days after the issuance of the test report. Further enquiry of validity or verification of the test report should be addressed to AGC by agc01@agccert.com.

Conducted Power of LTE Band 2(dBm)								
Bandwidth	Modulation	RB size	RB offset	Target MPR	Channel	Channel	Channel	
					18625	18900	19175	
5MHz	QPSK	1	0	0	21.18	21.84	22.12	
			13	0	21.50	20.34	21.57	
			24	0	21.64	20.89	21.24	
		12	0	1	20.32	20.45	20.90	
			6	1	20.43	21.46	20.90	
			13	1	20.62	21.04	20.43	
		25	0	1	20.52	21.22	20.64	
		16QAM	1	0	1	19.97	20.76	21.24
				13	1	20.11	21.25	20.95
	24			1	20.46	21.03	20.41	
	12		0	2	19.53	21.60	20.03	
			6	2	19.53	21.60	19.93	
			13	2	19.63	22.09	19.58	
	25	0	2	19.84	21.29	19.76		
	Bandwidth	Modulation	RB size	RB offset	Target MPR	Channel	Channel	Channel
					18650	18900	19150	
10MHz	QPSK	1	0	0	21.35	21.96	23.09	
			25	0	21.98	21.60	22.68	
			49	0	22.55	21.34	21.43	
		25	0	1	20.67	22.75	21.77	
			13	1	20.67	21.76	21.77	
			25	1	21.25	21.99	20.92	
		50	0	1	21.05	22.33	21.27	
		16QAM	1	0	1	20.43	21.20	22.57
				25	1	21.13	21.10	21.99
	49			1	21.62	21.40	20.62	
	25		0	2	19.74	22.95	21.02	
			13	2	19.74	21.71	21.02	
			25	2	20.33	21.77	20.04	
	50		0	2	20.23	21.51	20.37	

Any report having not been signed by authorized approver, or having been altered without authorization, or having not been stamped by the "Dedicated Testing/Inspection Stamp" is deemed to be invalid. Copying or excerpting portion of, or altering the content of the report is not permitted without the written authorization of AGC. The test results presented in the report apply only to the tested sample. Any objections to report issued by AGC should be submitted to AGC within 15days after the issuance of the test report. Further enquiry of validity or verification of the test report should be addressed to AGC by agc01@agccert.com.

Conducted Power of LTE Band 2(dBm)								
Bandwidth	Modulation	RB size	RB offset	Target MPR	Channel	Channel	Channel	
					18675	18900	19125	
15MHz	QPSK	1	0	0	21.28	21.63	<b>23.60</b>	
			38	0	22.20	21.34	22.87	
			74	0	23.55	22.77	21.44	
		36	0	1	21.34	21.25	21.74	
			18	1	21.33	21.24	21.82	
			39	1	21.32	21.24	21.81	
		75	0	1	21.40	21.24	21.80	
		16QAM	1	0	1	20.24	21.68	22.93
				38	1	21.28	21.20	22.03
	74			1	22.54	21.91	20.51	
	36		0	2	21.33	21.25	21.82	
			18	2	21.32	21.24	21.82	
			39	2	21.40	22.24	21.81	
	75	0	2	20.37	21.33	20.87		
	Bandwidth	Modulation	RB size	RB offset	Target MPR	Channel	Channel	Channel
					18700	18900	19100	
20MHz	QPSK	1	0	0	21.28	21.27	21.22	
			50	0	22.97	21.62	23.09	
			99	0	21.45	22.48	21.43	
		50	0	1	20.97	21.68	22.77	
			25	1	20.86	21.68	22.69	
			50	1	22.81	21.53	21.44	
		100	0	1	22.15	22.09	22.11	
		16QAM	1	0	1	20.55	21.47	23.09
				50	1	22.06	21.98	21.94
	99			1	21.55	21.74	20.27	
	50		0	2	20.13	22.78	21.92	
			25	2	20.02	21.79	21.84	
			50	2	21.99	23.55	20.65	
	100		0	2	21.23	21.16	21.36	

Any report having not been signed by authorized approver, or having been altered without authorization, or having not been stamped by the "Dedicated Testing/Inspection Stamp" is deemed to be invalid. Copying or excerpting portion of, or altering the content of the report is not permitted without the written authorization of AGC. The test results presented in the report apply only to the tested sample. Any objections to report issued by AGC should be submitted to AGC within 15days after the issuance of the test report. Further enquiry of validity or verification of the test report should be addressed to AGC by agc01@agccert.com.

Conducted Power of LTE Band 4(dBm)							
Bandwidth	Modulation	RB size	RB offset	Target MPR	Channel	Channel	Channel
					19957	20175	20393
1.4MHz	QPSK	1	0	0	20.69	21.85	21.41
			3	0	20.59	21.06	21.60
			5	0	20.48	20.16	21.56
		3	0	0	20.57	20.80	22.53
			2	0	20.48	20.79	22.45
			3	0	20.34	21.92	22.56
	6	0	1	19.37	23.78	21.51	
	16QAM	1	0	1	19.74	20.05	22.60
			3	1	19.86	21.35	21.83
			5	1	19.42	22.30	22.52
		3	0	1	19.32	23.72	22.35
			2	1	19.41	23.63	22.43
			3	1	19.19	23.76	21.70
	6	0	2	18.52	23.02	22.61	
Bandwidth	Modulation	RB size	RB offset	Target MPR	Channel	Channel	Channel
					19965	20175	20385
3MHz	QPSK	1	0	0	20.72	21.97	21.18
			7	0	20.11	21.81	21.47
			14	0	20.03	22.38	21.75
		8	0	1	19.39	23.77	22.45
			4	1	19.39	23.78	21.39
			7	1	19.17	21.04	22.55
	15	0	1	19.29	23.87	22.41	
	16QAM	1	0	1	19.52	23.63	21.20
			7	1	19.04	22.94	21.32
			14	1	18.89	22.99	22.68
		8	0	2	18.52	22.98	21.60
			4	2	18.52	22.90	22.42
			7	2	18.19	23.16	21.57
	15	0	2	18.28	22.89	22.46	

Any report having not been signed by authorized approver, or having been altered without authorization, or having not been stamped by the "Dedicated Testing/Inspection Stamp" is deemed to be invalid. Copying or excerpting portion of, or altering the content of the report is not permitted without the written authorization of AGC. The test results presented in the report apply only to the tested sample. Any objections to report issued by AGC should be submitted to AGC within 15days after the issuance of the test report. Further enquiry of validity or verification of the test report should be addressed to AGC by agc01@agccert.com.



Conducted Power of LTE Band 4(dBm)								
Bandwidth	Modulation	RB size	RB offset	Target MPR	Channel	Channel	Channel	
					19975	20175	20375	
5MHz	QPSK	1	0	0	20.62	21.58	21.09	
			13	0	19.91	22.99	21.44	
			24	0	19.84	21.21	22.89	
		12	0	1	19.25	23.64	21.20	
			6	1	19.34	23.64	22.22	
			13	1	19.02	22.06	21.53	
		25	0	1	19.13	23.80	21.30	
		16QAM	1	0	1	19.30	23.60	21.13
				13	1	18.78	23.85	22.38
	24			1	18.46	22.46	22.84	
	12		0	2	18.34	22.81	21.27	
			6	2	18.43	22.81	21.37	
			13	2	18.03	23.23	21.61	
	25	0	2	18.15	22.99	21.37		
	Bandwidth	Modulation	RB size	RB offset	Target MPR	Channel	Channel	Channel
20000						20175	20350	
10MHz	QPSK	1	0	0	20.43	22.24	21.63	
			25	0	20.07	21.08	21.95	
			49	0	21.37	21.61	21.84	
		25	0	1	19.09	23.49	22.36	
			13	1	19.10	23.48	22.29	
			25	1	19.53	22.22	21.23	
		50	0	1	19.29	<b>23.89</b>	22.72	
		16QAM	1	0	1	19.46	22.96	21.68
				25	1	19.53	22.92	22.98
	49			1	20.23	21.77	21.21	
	25		0	2	18.28	22.70	22.41	
			13	2	18.28	22.67	21.41	
			25	2	18.60	23.35	22.37	
	50		0	2	18.36	23.02	21.02	

Any report having not been signed by authorized approver, or having been altered without authorization, or having not been stamped by the "Dedicated Testing/Inspection Stamp" is deemed to be invalid. Copying or excerpting portion of, or altering the content of the report is not permitted without the written authorization of AGC. The test results presented in the report apply only to the tested sample. Any objections to report issued by AGC should be submitted to AGC within 15days after the issuance of the test report. Further enquiry of validity or verification of the test report should be addressed to AGC by agc01@agccert.com.

Conducted Power of LTE Band 4(dBm)								
Bandwidth	Modulation	RB size	RB offset	Target MPR	Channel	Channel	Channel	
					20025	20175	20325	
15MHz	QPSK	1	0	0	20.61	23.34	22.03	
			38	0	20.56	21.87	21.36	
			74	0	23.06	21.65	21.68	
		36	0	1	20.18	23.78	21.35	
			18	1	20.18	23.77	22.31	
			39	1	20.18	23.85	22.31	
		75	0	1	20.07	23.85	22.31	
		16QAM	1	0	1	19.49	22.50	21.21
				38	1	20.30	23.75	21.14
	74			1	22.19	21.68	22.70	
	36		0	2	20.17	23.77	21.31	
			18	2	20.18	23.86	22.31	
			39	2	20.17	23.85	21.31	
	75	0	2	19.14	23.07	21.35		
	Bandwidth	Modulation	RB size	RB offset	Target MPR	Channel	Channel	Channel
					20050	20175	20300	
20MHz	QPSK	1	0	0	22.86	22.94	22.89	
			50	0	21.88	22.00	22.74	
			99	0	22.17	21.14	21.77	
		50	0	1	19.47	22.98	21.98	
			25	1	19.38	22.98	21.98	
			50	1	22.11	21.52	20.66	
		100	0	1	20.84	23.75	21.98	
		16QAM	1	0	1	19.49	22.25	21.48
				50	1	21.14	22.26	22.47
	99			1	23.25	22.57	21.52	
	50		0	2	18.57	22.11	21.24	
			25	2	18.57	22.11	21.24	
			50	2	21.10	23.55	22.77	
	100		0	2	20.02	22.85	22.11	

Any report having not been signed by authorized approver, or having been altered without authorization, or having not been stamped by the "Dedicated Testing/Inspection Stamp" is deemed to be invalid. Copying or excerpting portion of, or altering the content of the report is not permitted without the written authorization of AGC. The test results presented in the report apply only to the tested sample. Any objections to report issued by AGC should be submitted to AGC within 15days after the issuance of the test report. Further enquiry of validity or verification of the test report should be addressed to AGC by agc01@agccert.com.

Conducted Power of LTE Band 5(dBm)								
Bandwidth	Modulation	RB size	RB offset	Target MPR	Channel	Channel	Channel	
					20407	20525	20643	
1.4MHz	QPSK	1	0	0	18.18	20.44	22.28	
			3	0	19.95	21.78	22.66	
			5	0	19.72	20.78	22.65	
		3	0	0	19.97	21.56	22.33	
			2	0	18.00	20.65	22.31	
			3	0	19.68	20.86	22.50	
	6	0	1	20.93	21.70	21.40		
	16QAM	1	0	1	19.50	20.43	21.59	
			3	1	20.22	21.02	21.95	
			5	1	20.04	21.17	21.77	
		3	0	1	20.95	21.52	21.14	
			2	1	20.12	21.52	21.24	
			3	1	20.80	20.87	21.38	
		6	0	2	20.02	21.83	20.60	
		Bandwidth	Modulation	RB size	RB offset	Target MPR	Channel	Channel
20415							20525	20635
3MHz	QPSK	1	0	0	21.09	20.12	21.34	
			7	0	23.40	20.72	22.05	
			14	0	22.99	21.58	22.58	
		8	0	1	22.95	19.57	20.76	
			4	1	22.86	19.50	20.76	
			7	1	22.29	20.13	21.40	
	15	0	1	22.54	19.81	21.09		
	16QAM	1	0	1	23.16	19.04	20.30	
			7	1	22.28	20.04	21.06	
			14	1	22.07	20.72	21.48	
		8	0	2	22.05	18.51	19.72	
			4	2	21.86	18.68	19.83	
			7	2	21.42	19.24	20.51	
		15	0	2	21.62	18.89	20.08	

Any report having not been signed by authorized approver, or having been altered without authorization, or having not been stamped by the "Dedicated Testing/Inspection Stamp" is deemed to be invalid. Copying or excerpting portion of, or altering the content of the report is not permitted without the written authorization of AGC. The test results presented in the report apply only to the tested sample. Any objections to report issued by AGC should be submitted to AGC within 15days after the issuance of the test report. Further enquiry of validity or verification of the test report should be addressed to AGC by agc01@agccert.com.

Conducted Power of LTE Band 5(dBm)								
Bandwidth	Modulation	RB size	RB offset	Target MPR	Channel	Channel	Channel	
					20425	20525	20625	
5MHz	QPSK	1	0	0	23.91	20.07	20.50	
			13	0	22.98	20.97	21.72	
			24	0	21.71	21.70	22.66	
		12	0	1	22.47	19.33	20.06	
			6	1	22.47	19.34	20.02	
			13	1	21.58	20.38	21.13	
		25	0	1	22.00	19.89	20.53	
		16QAM	1	0	1	22.75	18.79	19.29
				13	1	21.81	19.74	20.35
	24			1	20.23	21.14	21.23	
	12		0	2	21.46	18.20	19.05	
			6	2	21.43	18.38	19.01	
			13	2	20.45	19.31	20.19	
	25	0	2	21.20	18.74	19.62		
	Bandwidth	Modulation	RB size	RB offset	Target MPR	Channel	Channel	Channel
20450						20525	20600	
10MHz	QPSK	1	0	0	23.75	23.95	23.88	
			25	0	21.52	21.07	20.28	
			49	0	19.79	23.29	22.40	
		25	0	1	21.84	19.22	18.38	
			13	1	21.84	19.24	18.39	
			25	1	19.54	21.08	20.45	
		50	0	1	20.96	20.22	19.41	
		16QAM	1	0	1	22.91	18.98	20.00
				25	1	21.06	20.08	19.25
	49			1	18.81	22.45	21.53	
	25		0	2	20.81	18.13	20.28	
			13	2	20.90	18.23	20.27	
			25	2	18.53	20.07	19.41	
	50		0	2	19.89	19.27	18.45	

Any report having not been signed by authorized approver, or having been altered without authorization, or having not been stamped by the "Dedicated Testing/Inspection Stamp" is deemed to be invalid. Copying or excerpting portion of, or altering the content of the report is not permitted without the written authorization of AGC. The test results presented in the report apply only to the tested sample. Any objections to report issued by AGC should be submitted to AGC within 15days after the issuance of the test report. Further enquiry of validity or verification of the test report should be addressed to AGC by agc01@agccert.com.

Conducted Power of LTE Band 12(dBm)							
Bandwidth	Modulation	RB size	RB offset	Target MPR	Channel	Channel	Channel
					23017	23095	23173
1.4MHz	QPSK	1	0	0	21.28	18.90	20.91
			3	0	21.08	18.70	20.89
			5	0	21.05	18.51	20.02
		3	0	0	20.92	18.79	20.01
			2	0	21.01	18.77	21.91
			3	0	20.85	18.71	20.78
	6	0	1	20.12	19.66	21.92	
	16QAM	1	0	1	19.72	18.19	21.32
			3	1	20.23	18.17	20.92
			5	1	19.79	20.55	21.63
		3	0	1	19.78	20.68	20.02
			2	1	19.86	20.67	21.02
			3	1	19.74	20.43	21.07
	6	0	2	19.24	21.80	20.64	
Bandwidth	Modulation	RB size	RB offset	Target MPR	Channel	Channel	Channel
					23025	23095	23165
3MHz	QPSK	1	0	0	21.11	23.19	18.87
			7	0	21.82	22.80	18.39
			14	0	21.70	21.91	20.90
		8	0	1	21.23	22.13	20.63
			4	1	21.24	22.11	20.63
			7	1	23.89	21.40	21.19
	15	0	1	21.14	21.73	21.29	
	16QAM	1	0	1	21.21	22.21	20.94
			7	1	23.83	21.95	20.66
			14	1	23.66	21.09	20.00
		8	0	2	23.27	21.23	21.63
			4	2	23.23	21.23	21.55
			7	2	23.09	20.47	21.02
	15	0	2	22.96	20.75	21.23	

Any report having not been signed by authorized approver, or having been altered without authorization, or having not been stamped by the "Dedicated Testing/Inspection Stamp" is deemed to be invalid. Copying or excerpting portion of, or altering the content of the report is not permitted without the written authorization of AGC. The test results presented in the report apply only to the tested sample. Any objections to report issued by AGC should be submitted to AGC within 15days after the issuance of the test report. Further enquiry of validity or verification of the test report should be addressed to AGC by agc01@agccert.com.

Conducted Power of LTE Band 12(dBm)								
Bandwidth	Modulation	RB size	RB offset	Target MPR	Channel	Channel	Channel	
					23035	23095	23155	
5MHz	QPSK	1	0	0	21.14	23.83	19.97	
			13	0	21.71	22.74	18.53	
			24	0	22.44	21.25	20.90	
		12	0	1	21.08	22.27	18.30	
			6	1	22.11	22.27	18.33	
			13	1	23.54	21.08	20.20	
		25	0	1	23.80	21.63	20.79	
		16QAM	1	0	1	23.64	23.07	19.07
				13	1	23.19	21.45	20.63
	24			1	23.08	20.37	21.02	
	12		0	2	23.13	21.43	21.32	
			6	2	23.04	21.34	20.61	
			13	2	22.64	20.07	20.08	
	25	0	2	22.83	20.77	21.92		
	Bandwidth	Modulation	RB size	RB offset	Target MPR	Channel	Channel	Channel
					23060	23095	23130	
10MHz	QPSK	1	0	0	24.15	<b>24.33</b>	24.19	
			25	0	23.95	22.99	20.26	
			49	0	22.07	19.86	20.74	
		25	0	1	23.62	22.59	21.03	
			13	1	23.62	22.59	20.97	
			25	1	22.34	20.31	18.00	
		50	0	1	22.92	21.45	19.79	
		16QAM	1	0	1	21.05	23.35	22.68
				25	1	23.10	22.45	19.80
	49			1	21.53	18.52	20.28	
	25		0	2	22.80	21.72	20.14	
			13	2	22.80	21.72	20.03	
			25	2	21.36	19.58	19.24	
	50		0	2	22.02	20.44	18.72	

Any report having not been signed by authorized approver, or having been altered without authorization, or having not been stamped by the "Dedicated Testing/Inspection Stamp" is deemed to be invalid. Copying or excerpting portion of, or altering the content of the report is not permitted without the written authorization of AGC. The test results presented in the report apply only to the tested sample. Any objections to report issued by AGC should be submitted to AGC within 15days after the issuance of the test report. Further enquiry of validity or verification of the test report should be addressed to AGC by agc01@agccert.com.

Conducted Power of LTE Band 13(dBm)							
Bandwidth	Modulation	RB size	RB offset	Target MPR	Channel	Channel	Channel
					23205	23230	23255
5MHz	QPSK	1	0	0	21.95	22.21	22.42
			13	0	22.12	22.51	22.68
			24	0	22.21	22.59	<b>22.79</b>
		12	0	1	20.93	21.30	21.66
			6	1	20.84	21.21	21.50
			13	1	21.19	21.51	21.81
	25	1	21.04	21.33	21.58		
	16QAM	1	0	1	20.58	20.76	21.20
			13	1	20.80	21.13	21.94
			24	1	21.51	21.36	22.04
		12	0	2	19.82	20.19	20.53
			6	2	19.81	20.19	20.45
			13	2	20.09	20.41	20.74
		25	2	20.12	20.41	20.63	
Bandwidth		Modulation	RB size	RB offset	Target MPR	Channel	
10MHz	QPSK	1	0	0	21.82		
			25	0	22.68		
			49	0	22.76		
		25	0	1	21.12		
			13	1	21.12		
			25	1	21.58		
	50	1	21.33				
	16QAM	1	0	1	20.63		
			25	1	21.81		
			49	1	21.94		
		25	0	2	20.08		
			13	2	20.12		
			25	2	20.56		
		50	2	20.18			
Bandwidth		Modulation	RB size	RB offset	Target MPR	Channel	
					23230		

Any report having not been signed by authorized approver, or having been altered without authorization, or having not been stamped by the "Dedicated Testing/Inspection Stamp" is deemed to be invalid. Copying or excerpting portion of, or altering the content of the report is not permitted without the written authorization of AGC. The test results presented in the report apply only to the tested sample. Any objections to report issued by AGC should be submitted to AGC within 15days after the issuance of the test report. Further enquiry of validity or verification of the test report should be addressed to AGC by agc01@agccert.com.

Conducted Power of LTE Band 14(dBm)								
Bandwidth	Modulation	RB size	RB offset	Target MPR	Channel	Channel	Channel	
					23305	23330	23355	
5MHz	QPSK	1	0	0	22.72	22.98	22.69	
			13	0	22.94	22.97	22.80	
			24	0	22.77	22.82	22.50	
		3	0	1	21.99	21.92	21.92	
			6	1	22.00	21.92	21.83	
			13	1	21.90	21.96	21.63	
		6	0	1	21.99	21.86	21.76	
		16QAM	1	0	1	21.57	22.26	21.86
				13	1	21.73	21.97	21.86
	24			1	21.75	22.02	21.61	
	3		0	2	20.99	20.96	20.68	
			6	2	21.08	20.95	20.67	
			13	2	20.88	20.92	20.59	
	6	0	2	20.98	20.82	20.86		
	Bandwidth	Modulation	RB size	RB offset	Target MPR	Channel		
					23330			
10MHz	QPSK	1	0	0	22.90			
			25	0	23.04			
			49	0	22.26			
		8	0	1	22.03			
			13	1	22.02			
			25	1	21.91			
		15	0	1	21.92			
		16QAM	1	0	1	22.00		
				25	1	22.15		
	49			1	21.44			
	8		0	2	21.08			
			13	2	20.99			
			25	2	20.82			
	15	0	2	20.87				

Any report having not been signed by authorized approver, or having been altered without authorization, or having not been stamped by the "Dedicated Testing/Inspection Stamp" is deemed to be invalid. Copying or excerpting portion of, or altering the content of the report is not permitted without the written authorization of AGC. The test results presented in the report apply only to the tested sample. Any objections to report issued by AGC should be submitted to AGC within 15days after the issuance of the test report. Further enquiry of validity or verification of the test report should be addressed to AGC by agc01@agccert.com.



Conducted Power of LTE Band 66(dBm)							
Bandwidth	Modulation	RB size	RB offset	Target MPR	Channel	Channel	Channel
					131979	132422	132665
1.4MHz	QPSK	1	0	0	20.68	22.45	22.49
			2	0	20.57	21.87	21.60
			5	0	20.46	21.91	21.53
		3	0	0	20.50	21.51	22.77
			1	0	20.46	22.59	21.75
			3	0	20.31	21.69	21.63
	6	0	1	19.45	21.63	21.78	
	16QAM	1	0	1	19.90	20.40	21.70
			2	1	19.84	21.64	22.87
			5	1	19.56	20.71	21.95
		3	0	1	19.38	21.49	21.75
			1	1	19.38	21.62	21.74
			3	1	19.23	20.71	22.61
	6	0	2	18.59	21.52	21.11	
Bandwidth	Modulation	RB size	RB offset	Target MPR	Channel	Channel	Channel
					131987	132422	132657
3MHz	QPSK	1	0	0	20.51	21.47	21.33
			8	0	20.27	21.71	21.42
			14	0	20.07	21.96	21.60
		8	0	1	19.42	21.58	22.80
			4	1	19.42	22.58	21.62
			7	1	19.19	22.91	21.79
	15	0	1	19.31	21.69	20.62	
	16QAM	1	0	1	19.53	22.39	22.65
			8	1	19.11	22.94	21.69
			14	1	19.05	21.07	21.95
		8	0	2	18.62	21.81	22.67
			4	2	18.62	22.61	22.89
			7	2	18.41	21.03	21.84
	15	0	2	18.50	22.79	22.81	

Any report having not been signed by authorized approver, or having been altered without authorization, or having not been stamped by the "Dedicated Testing/Inspection Stamp" is deemed to be invalid. Copying or excerpting portion of, or altering the content of the report is not permitted without the written authorization of AGC. The test results presented in the report apply only to the tested sample. Any objections to report issued by AGC should be submitted to AGC within 15days after the issuance of the test report. Further enquiry of validity or verification of the test report should be addressed to AGC by agc01@agccert.com.

Conducted Power of LTE Band 66(dBm)								
Bandwidth	Modulation	RB size	RB offset	Target MPR	Channel	Channel	Channel	
					131997	132422	132647	
5MHz	QPSK	1	0	0	20.54	21.52	21.27	
			12	0	20.13	22.07	21.49	
			24	0	19.95	<b>23.39</b>	22.75	
		12	0	1	19.38	21.51	21.60	
			6	1	19.39	20.51	21.57	
			13	1	19.07	21.02	21.71	
		25	1	19.26	21.81	22.50		
		16QAM	1	0	1	19.30	22.76	21.48
				12	1	18.97	21.92	21.63
	24			1	19.27	20.31	21.01	
	12		0	2	18.40	21.66	21.51	
			6	2	18.40	21.66	22.52	
			13	2	18.17	21.17	21.84	
	25	2	18.46	22.87	21.71			
	Bandwidth	Modulation	RB size	RB offset	Target MPR	Channel	Channel	Channel
					132022	132422	132622	
10MHz	QPSK	1	0	0	20.45	21.08	21.16	
			24	0	20.30	20.98	20.61	
			49	0	21.30	20.02	20.57	
		25	0	1	19.24	21.37	21.41	
			12	1	19.25	20.45	22.43	
			25	1	19.76	21.42	21.42	
		50	1	19.37	20.92	22.44		
		16QAM	1	0	1	19.57	20.39	22.71
				24	1	19.71	20.66	21.87
	49			1	20.40	20.94	22.13	
	25		0	2	18.32	21.55	21.48	
			12	2	18.40	21.67	22.57	
			25	2	18.75	21.22	21.72	
	50		2	18.64	20.96	21.58		

Any report having not been signed by authorized approver, or having been altered without authorization, or having not been stamped by the "Dedicated Testing/Inspection Stamp" is deemed to be invalid. Copying or excerpting portion of, or altering the content of the report is not permitted without the written authorization of AGC. The test results presented in the report apply only to the tested sample. Any objections to report issued by AGC should be submitted to AGC within 15days after the issuance of the test report. Further enquiry of validity or verification of the test report should be addressed to AGC by agc01@agccert.com.

Conducted Power of LTE Band 66(dBm)								
Bandwidth	Modulation	RB size	RB offset	Target MPR	Channel	Channel	Channel	
					132047	132422	132597	
15MHz	QPSK	1	0	0	20.37	21.71	21.52	
			38	0	20.59	21.69	21.41	
			74	0	22.96	22.23	21.75	
		38	0	1	20.22	21.00	22.57	
			18	1	20.22	21.00	22.58	
			37	1	20.21	21.00	21.58	
		75	0	1	20.21	22.00	21.58	
		16QAM	1	0	1	19.54	21.04	21.09
				38	1	20.37	21.70	21.25
	74			1	22.01	22.39	21.83	
	38		0	2	20.22	21.00	20.58	
			18	2	20.21	21.00	21.58	
			37	2	20.21	21.00	20.58	
	75	0	2	19.20	22.13	20.62		
	Bandwidth	Modulation	RB size	RB offset	Target MPR	Channel	Channel	Channel
					132072	132422	132572	
20MHz	QPSK	1	0	0	21.72	21.71	21.79	
			49	0	21.75	20.06	22.62	
			99	0	21.32	21.87	20.79	
		50	0	1	19.58	20.20	21.59	
			25	1	19.48	20.20	21.58	
			50	1	21.98	21.89	22.44	
		100	0	1	20.89	21.09	21.38	
		16QAM	1	0	1	19.54	21.83	22.28
				49	1	21.37	22.41	22.15
	99			1	21.39	21.98	21.19	
	50		0	2	18.57	21.36	21.70	
			25	2	18.64	22.46	20.70	
			50	2	21.12	21.88	20.49	
	100	0	2	19.96	21.28	21.56		

Any report having not been signed by authorized approver, or having been altered without authorization, or having not been stamped by the "Dedicated Testing/Inspection Stamp" is deemed to be invalid. Copying or excerpting portion of, or altering the content of the report is not permitted without the written authorization of AGC. The test results presented in the report apply only to the tested sample. Any objections to report issued by AGC should be submitted to AGC within 15days after the issuance of the test report. Further enquiry of validity or verification of the test report should be addressed to AGC by agc01@agccert.com.

Conducted Power of LTE Band 71(dBm)								
Bandwidth	Modulation	RB size	RB offset	Target MPR	Channel	Channel	Channel	
					133147	133297	133447	
5MHz	QPSK	1	0	0	19.58	19.50	19.24	
			12	0	19.65	19.69	19.14	
			24	0	19.68	19.50	18.93	
		12	0	1	18.53	18.45	18.11	
			6	1	18.52	18.54	18.11	
			13	1	18.66	18.50	18.14	
		25	1	18.63	18.47	18.11		
		16QAM	1	0	1	18.38	18.18	18.25
				12	1	18.35	18.33	18.32
	24			1	18.33	18.53	17.96	
	12		0	2	17.50	17.68	17.12	
			6	2	17.60	17.59	17.12	
			13	2	17.55	17.56	17.08	
	25	2	17.82	17.53	17.24			
	Bandwidth	Modulation	RB size	RB offset	Target MPR	Channel	Channel	Channel
					133172	133297	133422	
10MHz	QPSK	1	0	0	19.52	19.35	19.54	
			24	0	19.74	19.82	19.66	
			49	0	19.31	19.41	18.95	
		25	0	1	18.76	18.51	18.50	
			12	1	18.59	18.51	18.55	
			25	1	18.45	18.64	18.22	
		50	1	18.54	18.53	18.31		
		16QAM	1	0	1	18.38	18.83	18.94
				24	1	18.84	18.53	18.74
	49			1	18.34	18.90	18.24	
	25		0	2	17.65	17.60	17.59	
			12	2	17.64	17.60	17.48	
			25	2	17.53	17.75	17.24	
	50		2	17.51	17.62	17.39		

Any report having not been signed by authorized approver, or having been altered without authorization, or having not been stamped by the "Dedicated Testing/Inspection Stamp" is deemed to be invalid. Copying or excerpting portion of, or altering the content of the report is not permitted without the written authorization of AGC. The test results presented in the report apply only to the tested sample. Any objections to report issued by AGC should be submitted to AGC within 15days after the issuance of the test report. Further enquiry of validity or verification of the test report should be addressed to AGC by agc01@agccert.com.

Conducted Power of LTE Band 71(dBm)								
Bandwidth	Modulation	RB size	RB offset	Target MPR	Channel	Channel	Channel	
					133197	133297	133397	
15MHz	QPSK	1	0	0	19.60	19.27	19.52	
			38	0	19.43	19.39	19.33	
			74	0	19.46	19.20	19.18	
		38	0	1	18.35	18.38	18.84	
			18	1	18.51	18.46	18.62	
			37	1	18.31	17.87	18.96	
		75	1	18.47	18.48	18.43		
		16QAM	1	0	1	18.56	18.25	19.01
				38	1	18.49	18.50	18.81
	74			1	18.61	18.63	18.27	
	38		0	2	18.39	18.36	18.84	
			18	2	18.36	18.50	18.71	
			37	2	18.50	17.85	18.90	
	75	2	17.42	17.57	17.52			
	Bandwidth	Modulation	RB size	RB offset	Target MPR	Channel	Channel	Channel
133222						133322	133372	
20MHz	QPSK	1	0	0	19.53	19.40	19.31	
			49	0	19.59	<b>19.90</b>	19.51	
			99	0	19.54	19.30	19.09	
		50	0	1	18.45	18.66	18.53	
			25	1	18.52	18.57	18.43	
			50	1	18.59	18.55	18.32	
		100	1	18.47	18.54	18.36		
		16QAM	1	0	1	18.61	18.71	18.24
				49	1	18.81	19.09	18.35
	99			1	18.75	18.85	17.75	
	50		0	2	17.59	17.67	17.54	
			25	2	17.58	17.59	17.55	
			50	2	17.65	17.71	17.55	
	100		2	17.64	17.61	17.44		

Any report having not been signed by authorized approver, or having been altered without authorization, or having not been stamped by the "Dedicated Testing/Inspection Stamp" is deemed to be invalid. Copying or excerpting portion of, or altering the content of the report is not permitted without the written authorization of AGC. The test results presented in the report apply only to the tested sample. Any objections to report issued by AGC should be submitted to AGC within 15days after the issuance of the test report. Further enquiry of validity or verification of the test report should be addressed to AGC by agc01@agccert.com.

The following tests were conducted according to the test requirements outlined in section 6.2 of the 3GPP TS36.101 specification.

UE Power Class: 3 (23 +/- 2dBm). The allowed Maximum Power Reduction (MPR) for the maximum output power due to higher order modulation and transmit bandwidth configuration (resource blocks) is specified in Table 6.2.3.3-1 of the 3GPP TS36.101.

**Table 6.2.3.3-1 Maximum Power Reduction (MPR) for Power class3**

Modulation	Maximum Power Reduction (MPR) for Power[RB]						MPR(dB)
	1.4MHz	3MHz	5MHz	10MHz	15MHz	20MHz	
QPSK	>5	>4	>8	>12	>16	>18	≤1
16QAM	≤5	≤4	≤8	≤12	≤16	≤18	≤1
16QAM	>5	>4	>8	>12	>16	>18	≤2

The allowed A-MPR values specified below in Table 6.2.4.3-1 of 3GPP TS36.101 are in addition to the allowed MPR requirements. All the measurements below were performed with A-MPR disabled, by using Network Signaling Value of "NS\_01".3

Any report having not been signed by authorized approver, or having been altered without authorization, or having not been stamped by the "Dedicated Testing/Inspection Stamp" is deemed to be invalid. Copying or excerpting portion of, or altering the content of the report is not permitted without the written authorization of AGC. The test results presented in the report apply only to the tested sample. Any objections to report issued by AGC should be submitted to AGC within 15days after the issuance of the test report. Further enquiry of validity or verification of the test report should be addressed to AGC by agc01@agccert.com.

**Table 6.2.4.3-1: Additional Maximum Power Reduction (A-MPR) / Spectrum Emission requirements**

Network Signaling value	Requirements (sub-clause)	E-UTRA Band	Channel bandwidth (MHz)	Resources Blocks ( $N_{RB}$ )	A-MPR (dB)
NS_01	6.6.2.1.1	Table 5.2-1	1.4,3,5,10,15,20	Table 5.4.2-1	N/A
NS_03	6.6.2.2.3.1	2,4,10, 23, 25,35,36	3	>5	$\leq 1$
			5	>6	$\leq 1$
			10	>6	$\leq 1$
			15	>8	$\leq 1$
			20	>10	$\leq 1$
NS_04	6.6.2.2.3.2	41	5	>6	$\leq 1$
			10, 15, 20	Table 6.2.4.3-4	
NS_05	6.6.3.3.3.1	1	10,15,20	$\geq 50$	$\leq 1$
NS_06	6.6.2.2.3.3	12, 13, 14, 17	1.4, 3, 5, 10	Table 5.4.2-1	N/A
NS_07	6.6.2.2.3.3 6.6.3.3.3.2	13	10	Table 6.2.4.3-2	Table 6.2.4.3-2
NS_08	6.6.3.3.3.3	19	10, 15	> 44	$\leq 3$
NS_09	6.6.3.3.3.4	21	10, 15	> 40	$\leq 1$
				> 55	$\leq 2$
NS_10		20	15, 20	Table 6.2.4.3-3	Table 6.2.4.3-3
NS_11	6.6.2.2.1 6.6.3.3.13	231	1.4, 3, 5, 10,15,20	Table 6.2.4.3-5	Table 6.2.4.3-5
NS_12	6.6.3.3.5	26	1.4, 3, 5	Table 6.2.4.3-6	Table 6.2.4.3-6
NS_13	6.6.3.3.6	26	5	Table 6.2.4.3-7	Table 6.2.4.3-7
NS_14	6.6.3.3.7	26	10, 15	Table 6.2.4.3-8	Table 6.2.4.3-8
NS_15	6.6.3.3.8	26	1.4, 3, 5, 10, 15	Table 6.2.4.3-9 Table 6.2.4.3-10	Table 6.2.4.3-9, Table 6.2.4.3-10
NS_16	6.6.3.3.9	27	3, 5, 10	Table 6.2.4.3-11, Table 6.2.4.3-12, Table 6.2.4.3-13	
NS_17	6.6.3.3.10 6.6.3.3.11	28 28	5, 10	Table 5.4.2-1	N/A
			5	$\geq 2$	$\leq 1$
NS_18			10, 15, 20	$\geq 1$	$\leq 4$
NS_19			10, 15, 20	Table 6.2.4.3-15	Table 6.2.4.3-15
NS_20			5, 10, 15, 20	Table 6.2.4.3-14	Table 6.2.4.3-14
...					
NS_20	-	-	-	-	-

Any report having not been signed by authorized approver, or having been altered without authorization, or having not been stamped by the "Dedicated Testing/Inspection Stamp" is deemed to be invalid. Copying or excerpting portion of, or altering the content of the report is not permitted without the written authorization of AGC. The test results presented in the report apply only to the tested sample. Any objections to report issued by AGC should be submitted to AGC within 15days after the issuance of the test report. Further enquiry of validity or verification of the test report should be addressed to AGC by agc01@agccert.com.

**WIFI**

Mode	Data Rate (Mbps)	Channel	Frequency(MHz)	Avg. Burst Power(dBm)
802.11b	1	01	2412	14.48
		06	2437	<b>14.51</b>
		11	2462	14.09
802.11g	6	01	2412	13.94
		06	2437	13.78
		11	2462	13.59
802.11n(20)	6.5	01	2412	13.45
		06	2437	13.26
		11	2462	13.37

**Bluetooth\_V5.0(BLE)**

Modulation	Channel	Frequency(MHz)	Peak Power (dBm)
GFSK	0	2402	<b>2.882</b>
	19	2440	2.848
	39	2480	2.325

Note:

Calculation Value = [(max. power of channel, mW)/(min. test separation distance, mm)] · [√f(GHz)].  
= 1.942/5 · √2.402 = 0.602 ≤ 3.0

**According to KDB447498 D01 V06, threshold at which no SAR required is ≤3.0 for 1-g SAR, separation distance is 5mm.**

Test Mode	Channel Frequency (MHz)	Field Strength (dBuV/m@3m)	Max Output power (mW)	Threshold Value(mW)
NFC-ASK	13.56MHz	62.25	0.00012647	442.9735094

Note:

- Max Output Power (dBm) = Field Strength of Fundamental (dBuV/m@3m)-95.23-6
- Max Output Power (mW) =  $10^{(\text{Max power (dBm)}/10)}$
- According to KDB447498 D01 V06, 4.3.1 c)  
For frequencies below 100 MHz, the following may be considered for SAR test exclusion (also illustrated in Appendix C):
  - For test separation distances > 50 mm and < 200 mm, the power threshold at the corresponding test separation distance at 100 MHz in step b) is multiplied by  $[1 + \log(100/f(\text{MHz}))]$
  - For test separation distances ≤ 50 mm, the power threshold determined by the equation in c) 1) for 50 mm and 100 MHz is multiplied by  $\frac{1}{2}$

Threshold Value =  $\{(3 \times 50 \text{mm} / \sqrt{0.1 \text{GHz}}) \times [1 + \log(100/13.56 \text{MHz})]\} / 2 = 442.9735094 \text{mW}$

**Since Max Output power (mW) of NFC is below SAR test exclusion power thresholds, the SAR evaluation of NFC is not required.**

Any report having not been signed by authorized approver, or having been altered without authorization, or having not been stamped by the "Dedicated Testing/Inspection Stamp" is deemed to be invalid. Copying or excerpting portion of, or altering the content of the report is not permitted without the written authorization of AGC. The test results presented in the report apply only to the tested sample. Any objections to report issued by AGC should be submitted to AGC within 15 days after the issuance of the test report. Further enquiry of validity or verification of the test report should be addressed to AGC by agc01@agccert.com.



5GHz WIFI

Mode	channel	Frequency	Power(dBm)							
			Data Rate(bps)							
			6M	9M	12M	18M	24M	36M	48M	54M
802.11a	36	5180	12.45	12.27	12.21	12.01	11.96	11.96	11.77	11.65
	40	5200	<b>12.48</b>	12.32	12.17	11.97	11.91	11.80	11.78	11.64
	44	5220	12.21	12.10	12.00	11.94	11.87	11.73	11.57	11.57
	48	5240	12.30	12.24	12.13	12.07	11.90	11.72	11.57	11.41
	52	5260	<b>11.72</b>	11.68	11.52	11.35	11.22	11.12	10.96	10.83
	56	5280	11.24	11.09	10.89	10.87	10.70	10.61	10.59	10.53
	60	5300	11.48	11.42	11.33	11.16	11.13	11.00	10.91	10.76
	64	5320	11.09	11.08	11.03	10.87	10.81	10.80	10.72	10.55
	100	5500	10.67	10.62	10.55	10.47	10.42	10.22	10.22	10.15
	104	5520	10.41	10.34	10.27	10.13	10.10	10.00	9.93	9.92
	108	5540	10.31	10.21	10.12	10.02	9.82	9.63	9.59	9.43
	112	5560	10.22	10.10	9.92	9.76	9.61	9.42	9.35	9.19
	116	5580	10.36	10.32	10.12	10.11	10.01	9.99	9.81	9.76
	120	5600	10.21	10.13	9.99	9.90	9.74	9.58	9.45	9.36
	124	5620	10.05	9.90	9.87	9.83	9.82	9.76	9.66	9.52
	128	5640	10.13	9.94	9.79	9.73	9.61	9.47	9.34	9.27
	132	5660	10.36	10.28	10.23	10.23	10.15	9.95	9.89	9.87
	136	5680	10.42	10.22	10.20	10.08	9.94	9.84	9.74	9.56
	140	5700	<b>10.74</b>	10.62	10.49	10.39	10.24	10.18	10.09	9.95
	149	5745	<b>10.95</b>	10.85	10.75	10.56	10.41	10.26	10.15	10.07
157	5785	10.76	10.75	10.61	10.43	10.28	10.14	10.03	9.93	
165	5825	10.28	10.19	10.07	9.93	9.92	9.87	9.69	9.57	

Any report having not been signed by authorized approver, or having been altered without authorization, or having not been stamped by the "Dedicated Testing/Inspection Stamp" is deemed to be invalid. Copying or excerpting portion of, or altering the content of the report is not permitted without the written authorization of AGC. The test results presented in the report apply only to the tested sample. Any objections to report issued by AGC should be submitted to AGC within 15days after the issuance of the test report. Further enquiry of validity or verification of the test report should be addressed to AGC by agc01@agccert.com.

Mode	channel	Frequency	Power(dBm)							
			Data Rate(bps)							
			MCS0	MCS1	MCS2	MCS3	MCS4	MCS5	MCS6	MCS7
802.11n (20)	36	5180	11.11	10.97	10.95	10.87	10.77	10.66	10.50	10.32
	40	5200	11.05	10.89	10.77	10.76	10.56	10.38	10.35	10.25
	44	5220	11.01	10.94	10.90	10.71	10.68	10.49	10.38	10.37
	48	5240	10.88	10.79	10.71	10.60	10.56	10.51	10.42	10.32
	52	5260	10.47	10.46	10.28	10.10	10.01	9.83	9.77	9.71
	56	5280	10.36	10.33	10.25	10.12	10.02	9.82	9.67	9.57
	60	5300	10.14	9.99	9.88	9.74	9.67	9.59	9.49	9.35
	64	5320	9.90	9.76	9.62	9.45	9.37	9.19	9.05	8.86
	100	5500	9.15	9.03	8.94	8.88	8.75	8.67	8.51	8.35
	104	5520	9.05	9.01	8.91	8.81	8.77	8.64	8.45	8.27
	108	5540	8.86	8.86	8.69	8.58	8.57	8.48	8.29	8.17
	112	5560	8.33	8.28	8.24	8.16	8.06	7.93	7.84	7.68
	116	5580	8.92	8.76	8.61	8.53	8.42	8.24	8.19	8.17
	120	5600	8.62	8.54	8.44	8.41	8.31	8.29	8.13	7.93
	124	5620	8.46	8.33	8.21	8.10	8.03	7.91	7.80	7.68
	128	5640	9.27	9.24	9.12	8.93	8.88	8.74	8.64	8.63
	132	5660	9.33	9.20	9.20	9.19	9.05	9.01	8.97	8.90
136	5680	9.13	9.05	8.88	8.71	8.56	8.46	8.28	8.17	
140	5700	9.41	9.24	9.18	9.07	9.00	8.88	8.73	8.58	
149	5745	9.50	9.45	9.28	9.17	9.10	9.04	8.96	8.77	
157	5785	9.26	9.18	9.16	9.10	9.09	8.92	8.81	8.71	
165	5825	8.81	8.80	8.63	8.50	8.37	8.28	8.11	8.04	
			MCS0	MCS1	MCS2	MCS3	MCS4	MCS5	MCS6	MCS7
802.11n (40)	38	5190	11.00	10.98	10.92	10.86	10.81	10.76	10.64	10.62
	46	5230	10.86	10.77	10.73	10.62	10.59	10.39	10.30	10.14
	54	5270	10.18	10.12	9.98	9.91	9.72	9.64	9.51	9.33
	62	5310	9.79	9.73	9.68	9.57	9.51	9.41	9.35	9.32
	102	5510	9.09	9.03	8.99	8.98	8.88	8.74	8.58	8.57
	110	5550	9.01	8.91	8.77	8.71	8.61	8.52	8.33	8.33
	118	5590	8.62	8.55	8.37	8.27	8.19	8.10	7.99	7.82
	126	5630	8.41	8.35	8.20	8.12	8.08	7.98	7.83	7.74
	134	5670	8.65	8.56	8.38	8.32	8.13	8.07	8.00	7.90
	151	5755	9.41	9.37	9.18	9.00	8.97	8.97	8.79	8.72
	159	5795	9.22	9.18	9.07	8.87	8.77	8.74	8.65	8.50

Any report having not been signed by authorized approver, or having been altered without authorization, or having not been stamped by the "Dedicated Testing/Inspection Stamp" is deemed to be invalid. Copying or excerpting portion of, or altering the content of the report is not permitted without the written authorization of AGC. The test results presented in the report apply only to the tested sample. Any objections to report issued by AGC should be submitted to AGC within 15days after the issuance of the test report. Further enquiry of validity or verification of the test report should be addressed to AGC by agc01@agccert.com.

Mode	channel	Frequency	Power(dBm)							
			Data Rate(bps)							
			MCS0	MCS1	MCS2	MCS3	MCS4	MCS5	MCS6	MCS7
802.11ac (20)	36	5180	11.21	11.04	10.98	10.79	10.62	10.54	10.51	10.36
	40	5200	11.23	11.18	11.06	10.88	10.83	10.75	10.62	10.45
	44	5220	11.06	10.92	10.73	10.60	10.55	10.54	10.42	10.27
	48	5240	10.97	10.78	10.60	10.53	10.39	10.22	10.09	10.04
	52	5260	10.70	10.58	10.46	10.31	10.25	10.20	10.15	9.96
	56	5280	10.63	10.54	10.37	10.36	10.32	10.31	10.25	10.12
	60	5300	10.49	10.45	10.26	10.24	10.07	10.06	9.87	9.78
	64	5320	10.09	9.92	9.90	9.72	9.55	9.41	9.40	9.24
	100	5500	9.22	9.14	8.96	8.80	8.76	8.61	8.56	8.48
	104	5520	9.13	9.06	8.99	8.86	8.71	8.58	8.45	8.39
	108	5540	9.01	8.98	8.96	8.81	8.70	8.57	8.44	8.29
	112	5560	8.91	8.79	8.63	8.50	8.31	8.16	8.16	8.15
	116	5580	8.89	8.88	8.76	8.60	8.59	8.50	8.41	8.34
	120	5600	8.96	8.77	8.76	8.65	8.51	8.44	8.36	8.21
	124	5620	8.81	8.79	8.65	8.48	8.43	8.32	8.30	8.15
	128	5640	8.96	8.86	8.66	8.49	8.34	8.33	8.23	8.20
	132	5660	9.02	8.96	8.90	8.73	8.54	8.39	8.33	8.26
	136	5680	9.13	8.98	8.98	8.86	8.80	8.75	8.64	8.61
140	5700	9.41	9.22	9.18	9.01	8.85	8.84	8.77	8.64	
149	5745	9.71	9.63	9.56	9.53	9.40	9.25	9.14	9.08	
157	5785	9.34	9.23	9.05	9.02	8.85	8.85	8.78	8.63	
165	5825	8.93	8.81	8.64	8.56	8.41	8.36	8.26	8.13	
			MCS0	MCS1	MCS2	MCS3	MCS4	MCS5	MCS6	MCS7
802.11ac (40)	38	5190	11.14	10.99	10.95	10.89	10.69	10.54	10.37	10.29
	46	5230	10.96	10.92	10.91	10.80	10.71	10.56	10.46	10.28
	54	5270	10.40	10.38	10.26	10.22	10.14	10.00	9.90	9.83
	62	5310	10.04	9.97	9.83	9.72	9.55	9.37	9.26	9.11
	102	5510	9.17	9.04	9.04	8.90	8.86	8.71	8.65	8.59
	110	5550	9.06	8.95	8.91	8.73	8.54	8.40	8.28	8.14
	118	5590	8.79	8.76	8.63	8.52	8.41	8.30	8.19	8.08
	126	5630	8.61	8.45	8.42	8.36	8.21	8.17	8.10	7.95
	134	5670	8.69	8.56	8.48	8.39	8.31	8.29	8.27	8.23
	151	5755	9.63	9.58	9.41	9.35	9.32	9.24	9.08	8.89
159	5795	9.22	9.18	8.99	8.99	8.81	8.79	8.73	8.70	
			MCS0	MCS1	MCS2	MCS3	MCS4	MCS5	MCS6	MCS7
802.11ac (80)	42	5210	10.57	10.41	10.27	10.19	10.06	9.90	9.74	9.68
	58	5290	9.96	9.95	9.92	9.74	9.56	9.54	9.46	9.45
	106	5530	8.26	8.18	7.99	7.98	7.91	7.85	7.74	7.55
	122	5610	8.10	7.90	7.71	7.56	7.51	7.39	7.32	7.28
	138	5690	8.05	8.03	7.87	7.76	7.62	7.46	7.34	7.28
155	5775	8.89	8.72	8.67	8.48	8.32	8.14	8.05	7.91	

Any report having not been signed by authorized approver, or having been altered without authorization, or having not been stamped by the "Dedicated Testing/Inspection Stamp" is deemed to be invalid. Copying or excerpting portion of, or altering the content of the report is not permitted without the written authorization of AGC. The test results presented in the report apply only to the tested sample. Any objections to report issued by AGC should be submitted to AGC within 15days after the issuance of the test report. Further enquiry of validity or verification of the test report should be addressed to AGC by agc01@agccert.com.

## 13. TEST RESULTS

### 13.1. SAR Test Results Summary

#### 13.1.1. Test position and configuration

Body-worn and 4 Edges SAR was performed with the device 0mm from the phantom.

#### 13.1.2. Operation Mode

1. Per KDB 447498 D01 v06 ,for each exposure position, if the highest 1-g SAR is  $\leq 0.8$  W/kg, testing for low and high channel is optional.
2. Per KDB 865664 D01 v01r04,for each frequency band, if the measured SAR is  $\geq 0.8$ W/kg, testing for repeated SAR measurement is required , that the highest measured SAR is only to be tested. When the SAR results are near the limit, the following procedures are required for each device to verify these types of SAR measurement related variation concerns by repeating the highest measured SAR configuration in each frequency band.
  - (1) When the original highest measured SAR is  $\geq 0.8$ W/kg, repeat that measurement once.
  - (2) Perform a second repeated measurement only if the ratio of largest to smallest SAR for the original and first repeated measurements is  $>1.20$  or when the original or repeated measurement is  $\geq 1.45$  W/kg.
  - (3) Perform a third repeated measurement only if the original, first and second repeated measurement is  $\geq 1.5$  W/kg and ratio of largest to smallest SAR for the original, first and second measurement is  $\geq 1.20$ .
3. Per KDB 248227 D01v02r02,for 2.4GHz 802.11g/n SAR testing is not required when the highest reported SAR for DSSS is adjusted by the ratio of OFDM to DSSS specified maximum output power and the adjusted SAR is  $\leq 1.2$ W/kg.
4. Per KDB 248227 D01 v02r02 Chapter 5.3.4, SAR measurement requirements for the remaining 802.11 transmission mode configurations that have not been tested in the initial test configuration are determined separately for each standalone and aggregated frequency band, in each exposure condition, according to the maximum output power specified for production units. The initial test position procedure is applied to next to the ear, UMPC mini-tablet and hotspot mode configurations. When the same maximum output power is specified for multiple transmission modes, the procedures in 5.3.2 are applied to determine the test configuration. Additional power measurements may be required to determine if SAR measurements are required for subsequent highest output power channels in a subsequent test configuration. The subsequent test configuration and SAR measurement procedures are described in the following.
  - (1) When SAR test exclusion provisions of KDB Publication 447498 D01 are applicable and SAR measurement is not required for the initial test configuration, SAR is also not required for the next highest maximum output power transmission mode subsequent test configuration(s) in that frequency band or aggregated band and exposure configuration.
  - (2) When the highest reported SAR for the initial test configuration (when applicable, include subsequent highest output channels), according to the initial test position or fixed exposure position requirements, is adjusted by the ratio of the subsequent test configuration to initial test configuration specified maximum output power and the adjusted SAR is  $\leq 1.2$  W/kg, SAR is not required for that subsequent test configuration.
5. Per KDB 941225 D06 V02r01, When the same wireless mode transmission configurations for voice and data are required for SAR measurements, the more conservative configuration with a smaller separation distance should be tested for the overlapping SAR configurations.
6. Maximum Scaling SAR in order to calculate the Maximum SAR values to test under the standard Peak Power, Calculation method is as follows:

Any report having not been signed by authorized approver, or having been altered without authorization, or having not been stamped by the "Dedicated Testing/Inspection Stamp" is deemed to be invalid. Copying or excerpting portion of, or altering the content of the report is not permitted without the written authorization of AGC. The test results presented in the report apply only to the tested sample. Any objections to report issued by AGC should be submitted to AGC within 15days after the issuance of the test report. Further enquiry of validity or verification of the test report should be addressed to AGC by [agc01@agccert.com](mailto:agc01@agccert.com).

Maximum Scaling SAR = tested SAR (Max.) × [maximum turn-up power (mw)/ maximum measurement output power(mw) ]

7. Proximity sensor, just for avoiding the wrong operation in the phone screen when call, and has no influence on output power or SAR result
8. Per KDB 941225 D05v02r05, start with the largest channel bandwidth and measure SAR for QPSK with 1RB allocation using the RB offset and required test channel combination with highest maximum output power for RB offsets at the upper edge, middle and lower edge of each required test channel.
9. Per KDB 941125 D05v02r05, 50% RB allocation for QPSK SAR testing follows 1RB QPSK allocation procedure.
10. Per KDB 941125 D05v02r05. For QPSK with 100% RB allocation. SAR is not required when the highest maximum output power for 100% RB allocation is less than the highest maximum output power in 50% and 1RB allocation and the highest reported SAR is >1.45 W/kg, the remaining required test channels must also be tested.
11. Per KDB 941125 D05v02r05. 16QAM output power for each RB allocation configuration is not 1/2 dB higher than the same configuration in QPSK and the reported SAR for the QPSK configuration is ≤1.45W/kg, Per KDB 941225 D05v02r05, 16QAM SAR testing is not required.
12. Per KDB 941125 D05v02r05. Smaller bandwidth output power for each RB allocation configuration is >not 1/2 dB higher than the same configuration in the largest supported bandwidth, and the reported SAR for the largest supported bandwidth is ≤1.45W/kg. Per KDB 941125 D05v02r05, smaller bandwidth SAR testing is not required.

Any report having not been signed by authorized approver, or having been altered without authorization, or having not been stamped by the "Dedicated Testing/Inspection Stamp" is deemed to be invalid. Copying or excerpting portion of, or altering the content of the report is not permitted without the written authorization of AGC. The test results presented in the report apply only to the tested sample. Any objections to report issued by AGC should be submitted to AGC within 15days after the issuance of the test report. Further enquiry of validity or verification of the test report should be addressed to AGC by agc01@agccert.com.

### 13.1.3. Test Result

SAR MEASUREMENT									
Depth of Liquid (cm):>15					Relative Humidity (%): 51.9				
Product: Body Worn Camera									
Test Mode: WCDMA Band II with QPSK modulation									
Position	Mode	Ch.	Fr. (MHz)	Power Drift (<math>\leq \pm 5\%</math>)	SAR (1g) (W/kg)	Max. Tune-up Power (dBm)	Meas. output Power (dBm)	Scaled SAR (W/kg)	Limit (W/kg)
Body back	RMC 12.2kbps	9400	1880	-0.21	0.038	22.00	21.68	0.041	1.6
Body front	RMC 12.2kbps	9400	1880	-0.09	0.611	22.00	21.68	0.658	1.6
Edge 2(Right)	RMC 12.2kbps	9400	1880	0.12	0.045	22.00	21.68	0.048	1.6
Edge 3(Bottom)	RMC 12.2kbps	9262	1852.4	-0.15	<b>1.230</b>	22.00	21.98	1.236	1.6
Edge 3(Bottom)	RMC 12.2kbps	9400	1880	-0.19	1.192	22.00	21.68	<b>1.283</b>	1.6
Edge 3(Bottom)	RMC 12.2kbps	9538	1907.6	-0.08	1.229	22.00	21.85	1.272	1.6
Edge 4(Left)	RMC 12.2kbps	9400	1880	0.15	0.469	22.00	21.68	0.505	1.6

Note:

- When the 1-g Reported SAR is  $\leq 0.8$  W/kg, testing for low and high channel is optional. Refer to KDB 447498.
- The test separation for body back, body front and 4 Edges is 0mm of all above table.

Any report having not been signed by authorized approver, or having been altered without authorization, or having not been stamped by the "Dedicated Testing/Inspection Stamp" is deemed to be invalid. Copying or excerpting portion of, or altering the content of the report is not permitted without the written authorization of AGC. The test results presented in the report apply only to the tested sample. Any objections to report issued by AGC should be submitted to AGC within 15days after the issuance of the test report. Further enquiry of validity or verification of the test report should be addressed to AGC by agc01@agccert.com.

SAR MEASUREMENT									
Depth of Liquid (cm):>15					Relative Humidity (%): 59.6				
Product: Body Worn Camera									
Test Mode: WCDMA Band IV with QPSK modulation									
Position	Mode	Ch.	Fr. (MHz)	Power Drift (<math>\pm 5\%</math>)	SAR (1g) (W/kg)	Max. Tune-up Power (dBm)	Meas. output Power (dBm)	Scaled SAR (W/kg)	Limit (W/kg)
Body back	RMC 12.2kbps	8662	1732.4	-0.22	0.044	22.40	22.34	0.045	1.6
Body front	RMC 12.2kbps	8662	1732.4	0.03	0.515	22.40	22.34	0.522	1.6
Edge 2(Right)	RMC 12.2kbps	8662	1732.4	-0.12	0.055	22.40	22.34	0.056	1.6
Edge 3(Bottom)	RMC 12.2kbps	8562	1712.4	-0.09	1.145	22.40	22.31	1.169	1.6
Edge 3(Bottom)	RMC 12.2kbps	8662	1732.4	0.26	1.104	22.40	22.34	1.119	1.6
Edge 3(Bottom)	RMC 12.2kbps	8763	1752.6	-0.05	<b>1.155</b>	22.40	22.21	<b>1.207</b>	1.6
Edge 4(Left)	RMC 12.2kbps	8662	1732.4	0.12	0.431	22.40	22.34	0.437	1.6

Note:

- When the 1-g Reported SAR is  $\leq 0.8$  W/kg, testing for low and high channel is optional. Refer to KDB 447498.
- The test separation for body back, body front and 4 Edges is 0mm of all above table.

Any report having not been signed by authorized approver, or having been altered without authorization, or having not been stamped by the “Dedicated Testing/Inspection Stamp” is deemed to be invalid. Copying or excerpting portion of, or altering the content of the report is not permitted without the written authorization of AGC. The test results presented in the report apply only to the tested sample. Any objections to report issued by AGC should be submitted to AGC within 15days after the issuance of the test report. Further enquiry of validity or verification of the test report should be addressed to AGC by agc01@agccert.com.

SAR MEASUREMENT									
Depth of Liquid (cm):>15					Relative Humidity (%): 53.3				
Product: Body Worn Camera									
Test Mode: WCDMA Band V with QPSK modulation									
Position	Mode	Ch.	Fr. (MHz)	Power Drift (<math>\pm 5\%</math>)	SAR (1g) (W/kg)	Max. Tune-up Power (dBm)	Meas. output Power (dBm)	Scaled SAR (W/kg)	Limit (W/kg)
Body back	RMC 12.2kbps	4183	836.4	-0.17	0.215	23.10	23.06	0.217	1.6
Body front	RMC 12.2kbps	4183	836.4	0.13	0.570	23.10	23.06	0.575	1.6
Edge 2(Right)	RMC 12.2kbps	4183	836.4	-0.29	0.525	23.10	23.06	0.530	1.6
Edge 3(Bottom)	RMC 12.2kbps	4132	826.4	0.26	1.368	23.10	23.04	1.387	1.6
Edge 3(Bottom)	RMC 12.2kbps	4183	836.4	-0.16	1.244	23.10	23.06	1.256	1.6
Edge 3(Bottom)	RMC 12.2kbps	4233	846.6	-0.32	<b>1.385</b>	23.10	23.09	<b>1.388</b>	1.6
Edge 4(Left)	RMC 12.2kbps	4183	836.4	0.36	0.133	23.10	23.06	0.134	1.6

Note:

- When the 1-g Reported SAR is  $\leq 0.8$  W/kg, testing for low and high channel is optional. Refer to KDB 447498.
- The test separation for body back, body front and 4 Edges is 0mm of all above table.

Any report having not been signed by authorized approver, or having been altered without authorization, or having not been stamped by the "Dedicated Testing/Inspection Stamp" is deemed to be invalid. Copying or excerpting portion of, or altering the content of the report is not permitted without the written authorization of AGC. The test results presented in the report apply only to the tested sample. Any objections to report issued by AGC should be submitted to AGC within 15days after the issuance of the test report. Further enquiry of validity or verification of the test report should be addressed to AGC by agc01@agccert.com.



SAR MEASUREMENT												
Depth of Liquid (cm):>15						Relative Humidity (%): 51.9						
Product: Body Worn Camera												
Test Mode: LTE Band 2												
BM MHz	MOD	Position	Test Mode		Ch.	Freq. (MHz)	Power Drift (<±5%)	SAR (1g) (W/kg)	Max. Tune up Power (dBm)	Meas. output Power (dBm)	Scaled SAR (W/kg)	Limit (W/kg)
			UL RB Allocation	UL RB START								
20	QPSK	Body back	1	0	18900	1880	-0.13	0.055	21.30	21.27	0.055	1.6
		Body front	1	0	18900	1880	0.43	0.646	21.30	21.27	0.650	1.6
		Edge 2(Right)	1	0	18900	1880	-0.18	0.037	21.30	21.27	0.037	1.6
		Edge 3(Bottom)	1	0	18700	1860	-0.31	1.177	21.30	21.28	1.182	1.6
		Edge 3(Bottom)	1	0	18900	1880	0.22	<b>1.333</b>	21.30	21.27	<b>1.342</b>	1.6
		Edge 3(Bottom)	1	0	19100	1900	-0.38	1.188	21.30	21.22	1.210	1.6
		Edge 4(Left)	1	0	18900	1880	0.28	0.397	21.30	21.27	0.400	1.6

Note:

- When the 1-g Reported SAR is ≤ 0.8 W/kg, testing for low and high channel is optional. Refer to KDB 447498.
- The test separation for body back, body front and 4 Edges is 0mm of all above table.

Any report having not been signed by authorized approver, or having been altered without authorization, or having not been stamped by the “Dedicated Testing/Inspection Stamp” is deemed to be invalid. Copying or excerpting portion of, or altering the content of the report is not permitted without the written authorization of AGC. The test results presented in the report apply only to the tested sample. Any objections to report issued by AGC should be submitted to AGC within 15days after the issuance of the test report. Further enquiry of validity or verification of the test report should be addressed to AGC by agc01@agccert.com.

SAR MEASUREMENT												
Depth of Liquid (cm):>15						Relative Humidity (%): 59.6						
Product: Body Worn Camera												
Test Mode: LTE Band 4												
BM MHz	MOD	Position	Test Mode		Ch.	Freq. (MHz)	Power Drift (<±5%)	SAR (1g) (W/kg)	Max. Tuneup Power (dBm)	Meas. output Power (dBm)	Scaled SAR (W/kg)	Limit (W/kg)
			UL RB Allocation	UL RB START								
20	QPSK	Body back	1	0	20175	1732.5	-0.07	0.047	23.00	22.94	0.048	1.6
		Body front	1	0	20175	1732.5	-0.18	0.528	23.00	22.94	0.535	1.6
		Edge 2(Right)	1	0	20175	1732.5	0.13	0.051	23.00	22.94	0.052	1.6
		Edge 3(Bottom)	1	0	20050	1720	-0.09	1.094	23.00	22.86	1.130	1.6
		Edge 3(Bottom)	1	0	20175	1732.5	-0.10	<b>1.288</b>	23.00	22.94	<b>1.306</b>	1.6
		Edge 3(Bottom)	1	0	20300	1745	-0.03	1.100	23.00	22.89	1.128	1.6
		Edge 4(Left)	1	0	20175	1732.5	0.23	0.346	23.00	22.94	0.351	1.6

Note:

- When the 1-g Reported SAR is ≤ 0.8 W/kg, testing for low and high channel is optional. Refer to KDB 447498.
- The test separation for body back, body front and 4 Edges is 0mm of all above table.

Any report having not been signed by authorized approver, or having been altered without authorization, or having not been stamped by the “Dedicated Testing/Inspection Stamp” is deemed to be invalid. Copying or excerpting portion of, or altering the content of the report is not permitted without the written authorization of AGC. The test results presented in the report apply only to the tested sample. Any objections to report issued by AGC should be submitted to AGC within 15days after the issuance of the test report. Further enquiry of validity or verification of the test report should be addressed to AGC by agc01@agccert.com.

SAR MEASUREMENT												
Depth of Liquid (cm):>15						Relative Humidity (%): 53.3						
Product: Body Worn Camera												
Test Mode: LTE Band 5												
BM MHz	MOD	Position	Test Mode		Ch.	Freq. (MHz)	Power Drift (<math>\leq \pm 5\%</math>)	SAR (1g) (W/kg)	Max. Tuneup Power (dBm)	Meas. output Power (dBm)	Scaled SAR (W/kg)	Limit (W/kg)
			UL RB Allocation	UL RB START								
10	QPSK	Body back	1	0	20525	836.5	-0.42	0.231	24.00	23.95	0.234	1.6
		Body front	1	0	20525	836.5	0.61	0.581	24.00	23.95	0.588	1.6
		Edge 2(Right)	1	0	20525	836.5	-0.19	0.637	24.00	23.95	0.644	1.6
		Edge 3(Bottom)	1	0	20450	829	-0.15	1.288	24.00	23.75	<b>1.364</b>	1.6
		Edge 3(Bottom)	1	0	20525	836.5	0.24	1.270	24.00	23.95	1.285	1.6
		Edge 3(Bottom)	1	0	20600	844	-0.19	<b>1.299</b>	24.00	23.88	1.335	1.6
		Edge 4(Left)	1	0	20525	836.5	-0.25	0.150	24.00	23.95	0.152	1.6

Note:

- When the 1-g Reported SAR is  $\leq 0.8$  W/kg, testing for low and high channel is optional. Refer to KDB 447498.
- The test separation for body back, body front and 4 Edges is 0mm of all above table.

Any report having not been signed by authorized approver, or having been altered without authorization, or having not been stamped by the "Dedicated Testing/Inspection Stamp" is deemed to be invalid. Copying or excerpting portion of, or altering the content of the report is not permitted without the written authorization of AGC. The test results presented in the report apply only to the tested sample. Any objections to report issued by AGC should be submitted to AGC within 15days after the issuance of the test report. Further enquiry of validity or verification of the test report should be addressed to AGC by agc01@agccert.com.

SAR MEASUREMENT												
Depth of Liquid (cm):>15						Relative Humidity (%): 51.7						
Product: Body Worn Camera												
Test Mode: LTE Band 12												
BM MHz	MOD	Position	Test Mode		Ch.	Freq. (MHz)	Power Drift (<math>\pm 5\%</math>)	SAR (1g) (W/kg)	Max. Tuneup Power (dBm)	Meas. output Power (dBm)	Scaled SAR (W/kg)	Limit (W/kg)
			UL RB Allocation	UL RB START								
10	QPSK	Body back	1	0	23095	707.5	-0.28	0.125	24.40	24.33	0.127	1.6
		Body front	1	0	23095	707.5	-0.34	0.526	24.40	24.33	0.535	1.6
		Edge 2(Right)	1	0	23095	707.5	-0.25	0.776	24.40	24.33	0.789	1.6
		Edge 3(Bottom)	1	0	23060	704	0.16	<b>1.206</b>	24.40	24.15	<b>1.277</b>	1.6
		Edge 3(Bottom)	1	0	23095	707.5	0.17	1.165	24.40	24.33	1.184	1.6
		Edge 3(Bottom)	1	0	23130	711	-0.21	1.197	24.40	24.19	1.256	1.6
		Edge 4(Left)	1	0	23095	707.5	-0.39	0.258	24.40	24.33	0.262	1.6

Note:

- When the 1-g Reported SAR is  $\leq 0.8$  W/kg, testing for low and high channel is optional. Refer to KDB 447498.
- The test separation for body back, body front and 4 Edges is 0mm of all above table.

Any report having not been signed by authorized approver, or having been altered without authorization, or having not been stamped by the "Dedicated Testing/Inspection Stamp" is deemed to be invalid. Copying or excerpting portion of, or altering the content of the report is not permitted without the written authorization of AGC. The test results presented in the report apply only to the tested sample. Any objections to report issued by AGC should be submitted to AGC within 15days after the issuance of the test report. Further enquiry of validity or verification of the test report should be addressed to AGC by agc01@agccert.com.

SAR MEASUREMENT												
Depth of Liquid (cm):>15						Relative Humidity (%): 51.7						
Product: Body Worn Camera												
Test Mode: LTE Band 13												
BM MHz	MOD	Position	Test Mode		Ch.	Freq. (MHz)	Power Drift (<math>\pm 5\%</math>)	SAR (1g) (W/kg)	Max. Tuneup Power (dBm)	Meas. output Power (dBm)	Scaled SAR (W/kg)	Limit (W/kg)
			UL RB Allocation	UL RB START								
10	QPSK	Body back	1	0	23230	782	-0.39	0.293	21.90	21.82	0.298	1.6
		Body front	1	0	23230	782	0.24	0.578	21.90	21.82	0.589	1.6
		Edge 2(Right)	1	0	23230	782	-0.44	0.717	21.90	21.82	0.730	1.6
		Edge 3(Bottom)	1	0	23230	782	-0.21	<b>1.315</b>	21.90	21.82	<b>1.339</b>	1.6
		Edge 4(Left)	1	0	23230	782	0.14	0.360	21.90	21.82	0.367	1.6

Note:

- When the 1-g Reported SAR is  $\leq 0.8$  W/kg, testing for low and high channel is optional. Refer to KDB 447498.
- The test separation for body back, body front and 4 Edges is 0mm of all above table.

Any report having not been signed by authorized approver, or having been altered without authorization, or having not been stamped by the "Dedicated Testing/Inspection Stamp" is deemed to be invalid. Copying or excerpting portion of, or altering the content of the report is not permitted without the written authorization of AGC. The test results presented in the report apply only to the tested sample. Any objections to report issued by AGC should be submitted to AGC within 15days after the issuance of the test report. Further enquiry of validity or verification of the test report should be addressed to AGC by agc01@agccert.com.

SAR MEASUREMENT												
Depth of Liquid (cm):>15						Relative Humidity (%): 51.7						
Product: Body Worn Camera												
Test Mode: LTE Band 14												
BM MHz	MOD	Position	Test Mode		Ch.	Freq. (MHz)	Power Drift (<math>\pm 5\%</math>)	SAR (1g) (W/kg)	Max. Tuneup Power (dBm)	Meas. output Power (dBm)	Scaled SAR (W/kg)	Limit (W/kg)
			UL RB Allocation	UL RB START								
10	QPSK	Body back	1	0	23330	793	-0.02	0.361	23.00	22.90	0.369	1.6
		Body front	1	0	23330	793	0.12	0.570	23.00	22.90	0.583	1.6
		Edge 2(Right)	1	0	23330	793	-0.37	0.707	23.00	22.90	0.723	1.6
		Edge 3(Bottom)	1	0	23330	793	-0.07	<b>1.248</b>	23.00	22.90	<b>1.277</b>	1.6
		Edge 4(Left)	1	0	23330	793	0.16	0.309	23.00	22.90	0.316	1.6

Note:

- When the 1-g Reported SAR is  $\leq 0.8$  W/kg, testing for low and high channel is optional. Refer to KDB 447498.
- The test separation for body back, body front and 4 Edges is 0mm of all above table.

Any report having not been signed by authorized approver, or having been altered without authorization, or having not been stamped by the "Dedicated Testing/Inspection Stamp" is deemed to be invalid. Copying or excerpting portion of, or altering the content of the report is not permitted without the written authorization of AGC. The test results presented in the report apply only to the tested sample. Any objections to report issued by AGC should be submitted to AGC within 15days after the issuance of the test report. Further enquiry of validity or verification of the test report should be addressed to AGC by agc01@agccert.com.

SAR MEASUREMENT												
Depth of Liquid (cm):>15						Relative Humidity (%): 59.6						
Product: LTE smartphone												
Test Mode: LTE Band 66												
BW MHz	MOD	Position	Test Mode		Ch.	Freq. (MHz)	Power Drift (<±5%)	SAR (1g) (W/kg)	Max. Tuneup Power (dBm)	Meas. output Power (dBm)	Scaled SAR (W/Kg)	Limit (W/kg)
			UL RB Allocation	UL RB START								
20	QPSK	Body back	1	0	132422	1755	-0.12	0.042	21.80	21.71	0.043	1.6
		Body front	1	0	132422	1755	-0.35	0.415	21.80	21.71	0.424	1.6
		Edge 2(Right)	1	0	132422	1755	-0.75	0.044	21.80	21.71	0.045	1.6
		Edge 3(Bottom)	1	0	132072	1720	0.21	<b>1.280</b>	21.80	21.72	<b>1.304</b>	1.6
		Edge 3(Bottom)	1	0	132422	1755	-0.16	1.269	21.80	21.71	1.296	1.6
		Edge 3(Bottom)	1	0	132572	1770	0.25	1.255	21.80	21.79	1.258	1.6
		Edge 4(Left)	1	0	132422	1755	-0.35	0.295	21.80	21.71	0.301	1.6

Note:

- When the 1-g Reported SAR is ≤ 0.8 W/kg, testing for low and high channel is optional. Refer to KDB 447498.
- The test separation for body back, body front and 4 Edges is 0mm of all above table

Any report having not been signed by authorized approver, or having been altered without authorization, or having not been stamped by the “Dedicated Testing/Inspection Stamp” is deemed to be invalid. Copying or excerpting portion of, or altering the content of the report is not permitted without the written authorization of AGC. The test results presented in the report apply only to the tested sample. Any objections to report issued by AGC should be submitted to AGC within 15days after the issuance of the test report. Further enquiry of validity or verification of the test report should be addressed to AGC by agc01@agccert.com.

SAR MEASUREMENT												
Depth of Liquid (cm):>15						Relative Humidity (%): 51.7						
Product: LTE smartphone												
Test Mode: LTE Band 71												
BW MHz	MOD	Position	Test Mode		Ch.	Freq. (MHz)	Power Drift (<±5%)	SAR (1g) (W/kg)	Max. Tuneup Power (dBm)	Meas. output Power (dBm)	Scaled SAR (W/Kg)	Limit (W/kg)
			UL RB Allocation	UL RB START								
20	QPSK	Body back	1	0	133322	683	-0.06	0.081	19.60	19.40	0.085	1.6
		Body front	1	0	133322	683	0.43	0.609	19.60	19.40	0.638	1.6
		Edge 2(Right)	1	0	133322	683	-0.28	0.590	19.60	19.40	0.618	1.6
		Edge 3(Bottom)	1	0	133222	673	-0.26	<b>1.328</b>	19.60	19.53	<b>1.350</b>	1.6
		Edge 3(Bottom)	1	0	133322	683	0.09	1.213	19.60	19.40	1.270	1.6
		Edge 3(Bottom)	1	0	133372	688	-0.16	1.234	19.60	19.31	1.319	1.6
		Edge 4(Left)	1	0	133322	683	-0.19	0.162	19.60	19.40	0.170	1.6

Note:

- When the 1-g Reported SAR is ≤ 0.8 W/kg, testing for low and high channel is optional. Refer to KDB 447498.
- The test separation for body back, body front and 4 Edges is 0mm of all above table

Any report having not been signed by authorized approver, or having been altered without authorization, or having not been stamped by the “Dedicated Testing/Inspection Stamp” is deemed to be invalid. Copying or excerpting portion of, or altering the content of the report is not permitted without the written authorization of AGC. The test results presented in the report apply only to the tested sample. Any objections to report issued by AGC should be submitted to AGC within 15days after the issuance of the test report. Further enquiry of validity or verification of the test report should be addressed to AGC by agc01@agccert.com.



SAR MEASUREMENT									
Depth of Liquid (cm):>15					Relative Humidity (%): 54.9				
Product: Body Worn Camera									
Test Mode:802.11b									
Position	Mode	Ch.	Fr. (MHz)	Power Drift (<±5%)	SAR (1g) (W/kg)	Max. Tune-up Power (dBm)	Meas. output Power (dBm)	Scaled SAR (W/kg)	Limit (W/kg)
Body back	DTS	6	2437	-0.32	0.085	14.60	14.51	0.087	1.6
Body front	DTS	6	2437	0.27	0.285	14.60	14.51	0.291	1.6
Edge 1 (Top)	DTS	6	2437	-0.17	0.107	14.60	14.51	0.109	1.6
Edge 2(Right)	DTS	6	2437	-0.07	<b>0.369</b>	14.60	14.51	<b>0.377</b>	1.6
Edge 4(Left)	DTS	6	2437	0.35	0.064	14.60	14.51	0.065	1.6

Note:

- According to KDB248227, SAR is not required for 802.11n HT20/HT40 channels when the maximum average output power is less than 1/4 dB higher than that measured on the corresponding 802.11a/b channels.
- All of above “DTS” means data transmitters.
- The test separation for body back, body front and 4 Edges is 0mm of all above table.

Any report having not been signed by authorized approver, or having been altered without authorization, or having not been stamped by the “Dedicated Testing/Inspection Stamp” is deemed to be invalid. Copying or excerpting portion of, or altering the content of the report is not permitted without the written authorization of AGC. The test results presented in the report apply only to the tested sample. Any objections to report issued by AGC should be submitted to AGC within 15days after the issuance of the test report. Further enquiry of validity or verification of the test report should be addressed to AGC by agc01@agccert.com.

SAR MEASUREMENT								
Depth of Liquid (cm):>15					Relative Humidity (%): 49.8			
Product: Body Worn Camera								
Test Mode: 5.2GHz WIFI-802.11a								
Position	Ch.	Fr. (MHz)	Power Drift (<±5%)	SAR (1g) (W/kg)	Max. Tune-up Power (dBm)	Meas. output Power (dBm)	Scaled SAR (W/kg)	Limit (W/kg)
Body back	40	5200	-0.49	0.092	12.50	12.48	0.092	1.6
Body front	40	5200	0.21	<b>0.348</b>	12.50	12.48	<b>0.350</b>	1.6
Edge 2(Right)	40	5200	-0.18	0.240	12.50	12.48	0.241	1.6

Note:

- When the 1-g Reported SAR is  $\leq 0.8$  W/kg, testing for low and high channel is optional. Refer to KDB 447498.
- The test separation for body back, body front and 4 Edges is 0mm of all above table

Any report having not been signed by authorized approver, or having been altered without authorization, or having not been stamped by the "Dedicated Testing/Inspection Stamp" is deemed to be invalid. Copying or excerpting portion of, or altering the content of the report is not permitted without the written authorization of AGC. The test results presented in the report apply only to the tested sample. Any objections to report issued by AGC should be submitted to AGC within 15days after the issuance of the test report. Further enquiry of validity or verification of the test report should be addressed to AGC by agc01@agccert.com.

SAR MEASUREMENT								
Depth of Liquid (cm):>15					Relative Humidity (%): 54.3			
Product: Body Worn Camera								
Test Mode: 5.3GHz WIFI-802.11a								
Position	Ch.	Fr. (MHz)	Power Drift (<math>\pm 5\%</math>)	SAR (1g) (W/kg)	Max. Tune-up Power (dBm)	Meas. output Power (dBm)	Scaled SAR (W/kg)	Limit (W/kg)
Body back	60	5300	-0.13	0.092	11.80	11.48	0.099	1.6
Body front	60	5300	0.08	<b>0.368</b>	11.80	11.48	<b>0.396</b>	1.6
Edge 2 (Right)	60	5300	0.40	0.185	11.80	11.48	0.199	1.6

Note:

- When the 1-g Reported SAR is  $\leq 0.8$  W/kg, testing for low and high channel is optional. Refer to KDB 447498.
- The test separation for body back, body front and 4 Edges is 0mm of all above table

Any report having not been signed by authorized approver, or having been altered without authorization, or having not been stamped by the "Dedicated Testing/Inspection Stamp" is deemed to be invalid. Copying or excerpting portion of, or altering the content of the report is not permitted without the written authorization of AGC. The test results presented in the report apply only to the tested sample. Any objections to report issued by AGC should be submitted to AGC within 15days after the issuance of the test report. Further enquiry of validity or verification of the test report should be addressed to AGC by agc01@agccert.com.

SAR MEASUREMENT								
Depth of Liquid (cm):>15					Relative Humidity (%): 48.9			
Product: Body Worn Camera								
Test Mode: 5.6GHzWIFI-802.11a								
Position	Ch.	Fr. (MHz)	Power Drift (<math>\pm 5\%</math>)	SAR (1g) (W/kg)	Max. Tune-up Power (dBm)	Meas. output Power (dBm)	Scaled SAR (W/kg)	Limit (W/kg)
Body back	120	5600	-0.20	0.101	10.80	10.21	0.116	1.6
Body front	120	5600	-0.12	<b>0.328</b>	10.80	10.21	<b>0.376</b>	1.6
Edge 2 (Right)	120	5600	-0.19	0.241	10.80	10.21	0.276	1.6

Note:

- When the 1-g Reported SAR is  $\leq 0.8$  W/kg, testing for low and high channel is optional. Refer to KDB 447498.
- The test separation for body back, body front and 4 Edges is 0mm of all above table

Any report having not been signed by authorized approver, or having been altered without authorization, or having not been stamped by the "Dedicated Testing/Inspection Stamp" is deemed to be invalid. Copying or excerpting portion of, or altering the content of the report is not permitted without the written authorization of AGC. The test results presented in the report apply only to the tested sample. Any objections to report issued by AGC should be submitted to AGC within 15days after the issuance of the test report. Further enquiry of validity or verification of the test report should be addressed to AGC by agc01@agccert.com.

SAR MEASUREMENT								
Depth of Liquid (cm):>15					Relative Humidity (%): 46.6			
Product: Body Worn Camera								
Test Mode: 5.8GHz WIFI-802.11a								
Position	Ch.	Fr. (MHz)	Power Drift (<±5%)	SAR (1g) (W/kg)	Max. Tune-up Power (dBm)	Meas. output Power (dBm)	Scaled SAR (W/kg)	Limit (W/kg)
Body back	157	5785	-0.23	0.091	11.00	10.76	0.096	1.6
Body front	157	5785	-0.16	<b>0.292</b>	11.00	10.76	<b>0.309</b>	1.6
Edge 2 (Right)	157	5785	-0.47	0.127	11.00	10.76	0.134	1.6

Note:

- When the 1-g Reported SAR is ≤ 0.8 W/kg, testing for low and high channel is optional. Refer to KDB 447498.
- The test separation for body back, body front and 4 Edges is 0mm of all above table

Any report having not been signed by authorized approver, or having been altered without authorization, or having not been stamped by the “Dedicated Testing/Inspection Stamp” is deemed to be invalid. Copying or excerpting portion of, or altering the content of the report is not permitted without the written authorization of AGC. The test results presented in the report apply only to the tested sample. Any objections to report issued by AGC should be submitted to AGC within 15days after the issuance of the test report. Further enquiry of validity or verification of the test report should be addressed to AGC by agc01@agccert.com.

Repeated SAR											
Product: Body Worn Camera											
Test Mode: WCDMA Band II & WCDMA Band IV & WCDMA Band V & LTE Band 2& LTE Band 4& LTE Band 5& LTE Band 12& LTE Band 13& LTE Band 14& LTE Band 66& LTE Band 71											
Position	Mode	Ch.	Fr. (MHz)	Power Drift (<±5%)	Once SAR (1g) (W/kg)	Power Drift (<±5%)	Twice SAR (1g) (W/kg)	Power Drift (<±5%)	Third SAR (1g) (W/kg)	Limit W/kg	
Edge 3(Bottom)	RMC 12.2kbps	9262	1852.4	-0.12	1.215	--	--	--	--	1.6	
Edge 3(Bottom)	RMC 12.2kbps	8763	1752.6	0.05	1.151	--	--	--	--	1.6	
Edge 3(Bottom)	RMC 12.2kbps	4233	846.6	-0.10	1.383	--	--	--	--	1.6	
Position	Mode		Ch.	Fr. (MHz)	Power Drift (<±5%)	Once SAR (1g) (W/kg)	Power Drift (<±5%)	Twice SAR (1g) (W/kg)	Power Drift (<±5%)	Third SAR (1g) (W/kg)	Limit W/kg
	UL RB Allocation	UL RB START									
Edge 3(Bottom)	1	0	18900	1880	-0.11	1.219	--	--	--	--	1.6
Edge 3(Bottom)	1	0	20175	1732.5	-0.05	1.287	--	--	--	--	1.6
Edge 3(Bottom)	1	0	20600	844	0.23	1.296	--	--	--	--	1.6
Edge 3(Bottom)	1	0	23060	704	-0.04	1.167	--	--	--	--	1.6
Edge 3(Bottom)	1	0	23230	782	-0.24	1.312	--	--	--	--	1.6
Edge 3(Bottom)	1	0	23330	793	0.16	1.300	--	--	--	--	1.6
Edge 3(Bottom)	1	0	132072	1720	-0.20	1.248	--	--	--	--	1.6
Edge 3(Bottom)	1	0	133222	673	-0.03	1.258	--	--	--	--	1.6

Any report having not been signed by authorized approver, or having been altered without authorization, or having not been stamped by the "Dedicated Testing/Inspection Stamp" is deemed to be invalid. Copying or excerpting portion of, or altering the content of the report is not permitted without the written authorization of AGC. The test results presented in the report apply only to the tested sample. Any objections to report issued by AGC should be submitted to AGC within 15days after the issuance of the test report. Further enquiry of validity or verification of the test report should be addressed to AGC by agc01@agccert.com.

The second repeated SAR judge reference									
Product: Body Worn Camera									
Band	Position	Mode	Ch.	Fr. (MHz)	Original SAR (1g) (W/kg)	First SAR (1g) (W/kg)	Ratio	Limit	
WCDMA Band II	Edge 3(Bottom)	RMC 12.2kbps	9262	1852.4	1.230	1.215	1.012	<1.2	
WCDMA Band IV	Edge 3(Bottom)	RMC 12.2kbps	8763	1752.6	1.155	1.151	1.003	<1.2	
WCDMA Band V	Edge 3(Bottom)	RMC 12.2kbps	4233	846.6	1.385	1.383	1.001	<1.2	
Band	Position	Mode		Ch.	Fr. (MHz)	Original SAR (1g) (W/kg)	First SAR (1g) (W/kg)	Ratio	Limit
		UL RB Allocation	UL RB START						
LTE Band 2	Edge 3(Bottom)	1	0	18900	1880	1.333	1.219	1.094	<1.2
LTE Band 4	Edge 3(Bottom)	1	0	20175	1732.5	1.288	1.287	1.001	<1.2
LTE Band 5	Edge 3(Bottom)	1	0	20600	844	1.299	1.296	1.002	<1.2
LTE Band 12	Edge 3(Bottom)	1	0	23060	704	1.206	1.167	1.033	<1.2
LTE Band 13	Edge 3(Bottom)	1	0	23230	782	1.315	1.312	1.002	<1.2
LTE Band 14	Edge 3(Bottom)	1	0	23330	793	1.248	1.300	1.042	<1.2
LTE Band 66	Edge 3(Bottom)	1	0	132072	1720	1.280	1.248	1.026	<1.2
LTE Band 71	Edge 3(Bottom)	1	0	133222	673	1.328	1.258	1.056	<1.2

Any report having not been signed by authorized approver, or having been altered without authorization, or having not been stamped by the "Dedicated Testing/Inspection Stamp" is deemed to be invalid. Copying or excerpting portion of, or altering the content of the report is not permitted without the written authorization of AGC. The test results presented in the report apply only to the tested sample. Any objections to report issued by AGC should be submitted to AGC within 15days after the issuance of the test report. Further enquiry of validity or verification of the test report should be addressed to AGC by agc01@agccert.com.

**Simultaneous Multi-band Transmission Evaluation:**  
**Application Simultaneous Transmission information:**

NO	Simultaneous state	Portable Handset	
		Body-worn	Hotspot
1	WCDMA+ WLAN 2.4GHz (data) + Bluetooth(data)	Yes	Yes
2	LTE + WLAN 2.4GHz (data) + Bluetooth(data)	Yes	Yes
3	WCDMA+ WLAN 5GHz (data) + Bluetooth(data)	Yes	Yes
4	LTE + WLAN 5GHz (data) + Bluetooth(data)	Yes	Yes

NOTE:

- WLAN and BT with different antenna, and can transmit simultaneously.
- Simultaneous with every transmitter must be the same test position.
- KDB 447498 D01, BT SAR is excluded as below table.
- KDB 447498 D01, for handsets the test separation distance is determined by the smallest distance between the outer surface of the device and the user; which is 0mm for body-worn SAR.
- According to KDB 447498 D01 4.3.1, Standalone SAR test exclusion is as follow:  
For 100 MHz to 6 GHz and test separation distances  $\leq 50$  mm, the 1-g and 10-g SAR test exclusion thresholds are determined by the following:  

$$[(\text{max. power of channel, including tune-up tolerance, mW}) / (\text{min. test separation distance, mm})] \cdot [\sqrt{f(\text{GHz})}] \leq 3.0$$
for 1-g SAR, and  $\leq 7.5$  for 10-g extremity SAR<sup>30</sup>, where
  - f(GHz) is the RF channel transmit frequency in GHz
  - Power and distance are rounded to the nearest mW and mm before calculation<sup>31</sup>
  - The result is rounded to one decimal place for comparison
  - The values 3.0 and 7.5 are referred to as numeric thresholds in step b) below
The test exclusions are applicable only when the minimum test separation distance is  $\leq 50$  mm, and for transmission frequencies between 100 MHz and 6 GHz. When the minimum test separation distance is  $< 5$  mm, a distance of 5 mm according to 4.1 f) is applied to determine SAR test exclusion.
- If the test separation distance is  $< 5$ mm, 5mm is used for excluded SAR calculation.
- According to KDB 447498 D01 4.3.2, simultaneous transmission SAR test exclusion is as follow:
  - Simultaneous transmission SAR test exclusion is determined for each operating configuration and exposure condition according to the reported standalone SAR of each applicable simultaneous transmitting antenna.
  - Any transmitters and antennas should be considered when calculating simultaneous mode.
  - For mobile phone and PC, it's the sum of all transmitters and antennas at the same mode with same position in each applicable exposure condition
  - When the standalone SAR test exclusion of section 4.3.2 is applied to an antenna that transmits simultaneously with other antennas, the standalone SAR must be estimated according to the following to det  

$$(\text{max. power of channel, including tune-up tolerance, mW}) / (\text{min. test separation distance, mm}) \cdot [\sqrt{f(\text{GHz})} / x] \text{ W/kg}$$
for test separation distances  $\leq 50$  mm;  
where  $x = 7.5$  for 1-g SAR, and  $x = 18.75$  for 10-g SAR.

Any report having not been signed by authorized approver, or having been altered without authorization, or having not been stamped by the "Dedicated Testing/Inspection Stamp" is deemed to be invalid. Copying or excerpting portion of, or altering the content of the report is not permitted without the written authorization of AGC. The test results presented in the report apply only to the tested sample. Any objections to report issued by AGC should be submitted to AGC within 15days after the issuance of the test report. Further enquiry of validity or verification of the test report should be addressed to AGC by agc01@agccert.com.



8. When the sum of SAR is larger than the limit, SAR test exclusion is determined by the SAR to peak location separation ratio. The simultaneous transmitting antennas in each operating mode and exposure condition combination must be considered one pair at a time to determine the SAR to peak location separation ratio to qualify for test exclusion. The ratio is determined by  $(SAR1 + SAR2)1.5/R_i$ , rounded to two decimal digits, and must be  $\leq 0.04$  for all antenna pairs in the configuration to qualify for 1-g SAR test exclusion.

Estimated SAR		Max Power including Tune-up Tolerance		Separation Distance (mm)	Estimated SAR (W/kg)
		dBm	mW		
<b>BT</b>	Body	3	1.995	0	0.082

Any report having not been signed by authorized approver, or having been altered without authorization, or having not been stamped by the "Dedicated Testing/Inspection Stamp" is deemed to be invalid. Copying or excerpting portion of, or altering the content of the report is not permitted without the written authorization of AGC. The test results presented in the report apply only to the tested sample. Any objections to report issued by AGC should be submitted to AGC within 15days after the issuance of the test report. Further enquiry of validity or verification of the test report should be addressed to AGC by [agc01@agccert.com](mailto:agc01@agccert.com).

**Sum of the SAR for WCDMA Band II & Wi-Fi & BT:**

RF Exposure Conditions	Test Position	Simultaneous Transmission Scenario			Σ1-g SAR (W/kg)	SPLSR (Yes/No)
		WCDMA Band II	Wi-Fi DTS Band	Bluetooth		
Body-worn	Rear	0.041	0.087	0.082	0.210	No
	Front	0.658	0.291	0.082	1.031	No
	Edge 1	--	--	0.082	0.082	No
	Edge 2	0.048	0.377	0.082	0.507	No
	Edge 3	1.283	--	0.082	1.365	No
	Edge 4	0.505	--	0.082	0.587	No
RF Exposure Conditions	Test Position	Simultaneous Transmission Scenario			Σ1-g SAR (W/kg)	SPLSR (Yes/No)
		WCDMA Band II	5.2GHz Wi-Fi Band	Bluetooth		
Body-worn	Rear	0.041	0.092	0.082	0.215	No
	Front	0.658	0.350	0.082	1.090	No
	Edge 1	--	--	0.082	0.082	No
	Edge 2	0.048	0.241	0.082	0.371	No
	Edge 3	1.283	--	0.082	1.365	No
	Edge 4	0.505	--	0.082	0.587	No
RF Exposure Conditions	Test Position	Simultaneous Transmission Scenario			Σ1-g SAR (W/kg)	SPLSR (Yes/No)
		WCDMA Band II	5.3GHz Wi-Fi Band	Bluetooth		
Body-worn	Rear	0.041	0.099	0.082	0.222	No
	Front	0.658	0.396	0.082	1.136	No
	Edge 1	--	--	0.082	0.082	No
	Edge 2	0.048	0.199	0.082	0.329	No
	Edge 3	1.283	--	0.082	1.365	No
	Edge 4	0.505	--	0.082	0.587	No
RF Exposure Conditions	Test Position	Simultaneous Transmission Scenario			Σ1-g SAR (W/kg)	SPLSR (Yes/No)
		WCDMA Band II	5.6GHz Wi-Fi Band	Bluetooth		
Body-worn	Rear	0.041	0.116	0.082	0.239	No
	Front	0.658	0.376	0.082	1.116	No
	Edge 1	--	--	0.082	0.082	No
	Edge 2	0.048	0.276	0.082	0.406	No
	Edge 3	1.283	--	0.082	1.365	No
	Edge 4	0.505	--	0.082	0.587	No
RF Exposure Conditions	Test Position	Simultaneous Transmission Scenario			Σ1-g SAR (W/kg)	SPLSR (Yes/No)
		WCDMA Band II	5.8GHz Wi-Fi Band	Bluetooth		
Body-worn	Rear	0.041	0.096	0.082	0.219	No
	Front	0.658	0.309	0.082	1.049	No
	Edge 1	--	--	0.082	0.082	No
	Edge 2	0.048	0.134	0.082	0.264	No
	Edge 3	1.283	--	0.082	1.365	No
	Edge 4	0.505	--	0.082	0.587	No

**Note:**

- According to KDB 447498 D01 General RF Exposure Guidance, when the simultaneous transmission SAR is less than 1.6 W/kg, SPLSR assessment is not required.
- SPLSR mean is “The SAR to Peak Location Separation Ratio “

Any report having not been signed by authorized approver, or having been altered without authorization, or having not been stamped by the “Dedicated Testing/Inspection Stamp” is deemed to be invalid. Copying or excerpting portion of, or altering the content of the report is not permitted without the written authorization of AGC. The test results presented in the report apply only to the tested sample. Any objections to report issued by AGC should be submitted to AGC within 15 days after the issuance of the test report. Further enquiry of validity or verification of the test report should be addressed to AGC by agc01@agccert.com.

**Sum of the SAR for WCDMA Band IV & Wi-Fi & BT:**

RF Exposure Conditions	Test Position	Simultaneous Transmission Scenario			Σ1-g SAR (W/kg)	SPLSR (Yes/No)
		WCDMA Band IV	Wi-Fi DTS Band	Bluetooth		
Body-worn	Rear	0.045	0.087	0.082	0.214	No
	Front	0.522	0.291	0.082	0.895	No
	Edge 1	--	--	0.082	0.082	No
	Edge 2	0.056	0.377	0.082	0.515	No
	Edge 3	1.207	--	0.082	1.289	No
	Edge 4	0.437	--	0.082	0.519	No
RF Exposure Conditions	Test Position	Simultaneous Transmission Scenario			Σ1-g SAR (W/kg)	SPLSR (Yes/No)
		WCDMA Band IV	5.2GHz Wi-Fi Band	Bluetooth		
Body-worn	Rear	0.045	0.092	0.082	0.219	No
	Front	0.522	0.350	0.082	0.954	No
	Edge 1	--	--	0.082	0.082	No
	Edge 2	0.056	0.241	0.082	0.379	No
	Edge 3	1.207	--	0.082	1.289	No
	Edge 4	0.437	--	0.082	0.519	No
RF Exposure Conditions	Test Position	Simultaneous Transmission Scenario			Σ1-g SAR (W/kg)	SPLSR (Yes/No)
		WCDMA Band IV	5.3GHz Wi-Fi Band	Bluetooth		
Body-worn	Rear	0.045	0.099	0.082	0.226	No
	Front	0.522	0.396	0.082	1.000	No
	Edge 1	--	--	0.082	0.082	No
	Edge 2	0.056	0.199	0.082	0.337	No
	Edge 3	1.207	--	0.082	1.289	No
	Edge 4	0.437	--	0.082	0.519	No
RF Exposure Conditions	Test Position	Simultaneous Transmission Scenario			Σ1-g SAR (W/kg)	SPLSR (Yes/No)
		WCDMA Band IV	5.6GHz Wi-Fi Band	Bluetooth		
Body-worn	Rear	0.045	0.116	0.082	0.243	No
	Front	0.522	0.376	0.082	0.980	No
	Edge 1	--	--	0.082	0.082	No
	Edge 2	0.056	0.276	0.082	0.414	No
	Edge 3	1.207	--	0.082	1.289	No
	Edge 4	0.437	--	0.082	0.519	No
RF Exposure Conditions	Test Position	Simultaneous Transmission Scenario			Σ1-g SAR (W/kg)	SPLSR (Yes/No)
		WCDMA Band IV	5.8GHz Wi-Fi Band	Bluetooth		
Body-worn	Rear	0.045	0.096	0.082	0.223	No
	Front	0.522	0.309	0.082	0.913	No
	Edge 1	--	--	0.082	0.082	No
	Edge 2	0.056	0.134	0.082	0.272	No
	Edge 3	1.207	--	0.082	1.289	No
	Edge 4	0.437	--	0.082	0.519	No

**Note:**

- According to KDB 447498 D01 General RF Exposure Guidance, when the simultaneous transmission SAR is less than 1.6 W/kg, SPLSR assessment is not required.
- SPLSR mean is "The SAR to Peak Location Separation Ratio "

Any report having not been signed by authorized approver, or having been altered without authorization, or having not been stamped by the "Dedicated Testing/Inspection Stamp" is deemed to be invalid. Copying or excerpting portion of, or altering the content of the report is not permitted without the written authorization of AGC. The test results presented in the report apply only to the tested sample. Any objections to report issued by AGC should be submitted to AGC within 15 days after the issuance of the test report. Further enquiry of validity or verification of the test report should be addressed to AGC by agc01@agccert.com.

**Sum of the SAR for WCDMA Band V & Wi-Fi & BT:**

RF Exposure Conditions	Test Position	Simultaneous Transmission Scenario			Σ1-g SAR (W/kg)	SPLSR (Yes/No)
		WCDMA Band V	Wi-Fi DTS Band	Bluetooth		
Body-worn	Rear	0.217	0.087	0.082	0.386	No
	Front	0.575	0.291	0.082	0.948	No
	Edge 1	--	--	0.082	0.082	No
	Edge 2	0.530	0.377	0.082	0.989	No
	Edge 3	1.388	--	0.082	1.470	No
	Edge 4	0.134	--	0.082	0.216	No
RF Exposure Conditions	Test Position	Simultaneous Transmission Scenario			Σ1-g SAR (W/kg)	SPLSR (Yes/No)
		WCDMA Band V	5.2GHz Wi-Fi Band	Bluetooth		
Body-worn	Rear	0.217	0.092	0.082	0.391	No
	Front	0.575	0.350	0.082	1.007	No
	Edge 1	--	--	0.082	0.082	No
	Edge 2	0.530	0.241	0.082	0.853	No
	Edge 3	1.388	--	0.082	1.470	No
	Edge 4	0.134	--	0.082	0.216	No
RF Exposure Conditions	Test Position	Simultaneous Transmission Scenario			Σ1-g SAR (W/kg)	SPLSR (Yes/No)
		WCDMA Band II	5.3GHz Wi-Fi Band	Bluetooth		
Body-worn	Rear	0.217	0.099	0.082	0.398	No
	Front	0.575	0.396	0.082	1.053	No
	Edge 1	--	--	0.082	0.082	No
	Edge 2	0.530	0.199	0.082	0.811	No
	Edge 3	1.388	--	0.082	1.470	No
	Edge 4	0.134	--	0.082	0.216	No
RF Exposure Conditions	Test Position	Simultaneous Transmission Scenario			Σ1-g SAR (W/kg)	SPLSR (Yes/No)
		WCDMA Band V	5.6GHz Wi-Fi Band	Bluetooth		
Body-worn	Rear	0.217	0.116	0.082	0.415	No
	Front	0.575	0.376	0.082	1.033	No
	Edge 1	--	--	0.082	0.082	No
	Edge 2	0.530	0.276	0.082	0.888	No
	Edge 3	1.388	--	0.082	1.470	No
	Edge 4	0.134	--	0.082	0.216	No
RF Exposure Conditions	Test Position	Simultaneous Transmission Scenario			Σ1-g SAR (W/kg)	SPLSR (Yes/No)
		WCDMA Band V	5.8GHz Wi-Fi Band	Bluetooth		
Body-worn	Rear	0.217	0.096	0.082	0.395	No
	Front	0.575	0.309	0.082	0.966	No
	Edge 1	--	--	0.082	0.082	No
	Edge 2	0.530	0.134	0.082	0.746	No
	Edge 3	1.388	--	0.082	1.470	No
	Edge 4	0.134	--	0.082	0.216	No

**Note:**

- According to KDB 447498 D01 General RF Exposure Guidance, when the simultaneous transmission SAR is less than 1.6 W/kg, SPLSR assessment is not required.
- SPLSR mean is "The SAR to Peak Location Separation Ratio "

Any report having not been signed by authorized approver, or having been altered without authorization, or having not been stamped by the "Dedicated Testing/Inspection Stamp" is deemed to be invalid. Copying or excerpting portion of, or altering the content of the report is not permitted without the written authorization of AGC. The test results presented in the report apply only to the tested sample. Any objections to report issued by AGC should be submitted to AGC within 15 days after the issuance of the test report. Further enquiry of validity or verification of the test report should be addressed to AGC by agc01@agccert.com.

**Sum of the SAR for LTE Band 2 & Wi-Fi & BT:**

RF Exposure Conditions	Test Position	Simultaneous Transmission Scenario			Σ1-g SAR (W/kg)	SPLSR (Yes/No)
		LTE Band 2	Wi-Fi DTS Band	Bluetooth		
Body-worn	Rear	0.055	0.087	0.082	0.224	No
	Front	0.650	0.291	0.082	1.023	No
	Edge 1	--	--	0.082	0.082	No
	Edge 2	0.037	0.377	0.082	0.496	No
	Edge 3	1.342	--	0.082	1.424	No
	Edge 4	0.400	--	0.082	0.482	No
RF Exposure Conditions	Test Position	Simultaneous Transmission Scenario			Σ1-g SAR (W/kg)	SPLSR (Yes/No)
		LTE Band 2	5.2GHz Wi-Fi Band	Bluetooth		
Body-worn	Rear	0.055	0.092	0.082	0.229	No
	Front	0.650	0.350	0.082	1.082	No
	Edge 1	--	--	0.082	0.082	No
	Edge 2	0.037	0.241	0.082	0.360	No
	Edge 3	1.342	--	0.082	1.424	No
	Edge 4	0.400	--	0.082	0.482	No
RF Exposure Conditions	Test Position	Simultaneous Transmission Scenario			Σ1-g SAR (W/kg)	SPLSR (Yes/No)
		LTE Band 2	5.3GHz Wi-Fi Band	Bluetooth		
Body-worn	Rear	0.055	0.099	0.082	0.236	No
	Front	0.650	0.396	0.082	1.128	No
	Edge 1	--	--	0.082	0.082	No
	Edge 2	0.037	0.199	0.082	0.318	No
	Edge 3	1.342	--	0.082	1.424	No
	Edge 4	0.400	--	0.082	0.482	No
RF Exposure Conditions	Test Position	Simultaneous Transmission Scenario			Σ1-g SAR (W/kg)	SPLSR (Yes/No)
		LTE Band 2	5.6GHz Wi-Fi Band	Bluetooth		
Body-worn	Rear	0.055	0.116	0.082	0.253	No
	Front	0.650	0.376	0.082	1.108	No
	Edge 1	--	--	0.082	0.082	No
	Edge 2	0.037	0.276	0.082	0.395	No
	Edge 3	1.342	--	0.082	1.424	No
	Edge 4	0.400	--	0.082	0.482	No
RF Exposure Conditions	Test Position	Simultaneous Transmission Scenario			Σ1-g SAR (W/kg)	SPLSR (Yes/No)
		LTE Band 2	5.8GHz Wi-Fi Band	Bluetooth		
Body-worn	Rear	0.055	0.096	0.082	0.233	No
	Front	0.650	0.309	0.082	1.041	No
	Edge 1	--	--	0.082	0.082	No
	Edge 2	0.037	0.134	0.082	0.253	No
	Edge 3	1.342	--	0.082	1.424	No
	Edge 4	0.400	--	0.082	0.482	No

**Note:**

- According to KDB 447498 D01 General RF Exposure Guidance, when the simultaneous transmission SAR is less than 1.6 W/kg, SPLSR assessment is not required.
- SPLSR mean is "The SAR to Peak Location Separation Ratio"

Any report having not been signed by authorized approver, or having been altered without authorization, or having not been stamped by the "Dedicated Testing/Inspection Stamp" is deemed to be invalid. Copying or excerpting portion of, or altering the content of the report is not permitted without the written authorization of AGC. The test results presented in the report apply only to the tested sample. Any objections to report issued by AGC should be submitted to AGC within 15 days after the issuance of the test report. Further enquiry of validity or verification of the test report should be addressed to AGC by agc01@agccert.com.

**Sum of the SAR for LTE Band 4 & Wi-Fi & BT:**

RF Exposure Conditions	Test Position	Simultaneous Transmission Scenario			Σ1-g SAR (W/kg)	SPLSR (Yes/No)
		LTE Band 4	Wi-Fi DTS Band	Bluetooth		
Body-worn	Rear	0.048	0.087	0.082	0.217	No
	Front	0.535	0.291	0.082	0.908	No
	Edge 1	--	--	0.082	0.082	No
	Edge 2	0.052	0.377	0.082	0.511	No
	Edge 3	1.306	--	0.082	1.388	No
	Edge 4	0.351	--	0.082	0.433	No
RF Exposure Conditions	Test Position	Simultaneous Transmission Scenario			Σ1-g SAR (W/kg)	SPLSR (Yes/No)
		LTE Band 4	5.2GHz Wi-Fi Band	Bluetooth		
Body-worn	Rear	0.048	0.092	0.082	0.222	No
	Front	0.535	0.350	0.082	0.967	No
	Edge 1	--	--	0.082	0.082	No
	Edge 2	0.052	0.241	0.082	0.375	No
	Edge 3	1.306	--	0.082	1.388	No
	Edge 4	0.351	--	0.082	0.433	No
RF Exposure Conditions	Test Position	Simultaneous Transmission Scenario			Σ1-g SAR (W/kg)	SPLSR (Yes/No)
		LTE Band 4	5.3GHz Wi-Fi Band	Bluetooth		
Body-worn	Rear	0.048	0.099	0.082	0.229	No
	Front	0.535	0.396	0.082	1.013	No
	Edge 1	--	--	0.082	0.082	No
	Edge 2	0.052	0.199	0.082	0.333	No
	Edge 3	1.306	--	0.082	1.388	No
	Edge 4	0.351	--	0.082	0.433	No
RF Exposure Conditions	Test Position	Simultaneous Transmission Scenario			Σ1-g SAR (W/kg)	SPLSR (Yes/No)
		LTE Band 4	5.6GHz Wi-Fi Band	Bluetooth		
Body-worn	Rear	0.048	0.116	0.082	0.246	No
	Front	0.535	0.376	0.082	0.993	No
	Edge 1	--	--	0.082	0.082	No
	Edge 2	0.052	0.276	0.082	0.410	No
	Edge 3	1.306	--	0.082	1.388	No
	Edge 4	0.351	--	0.082	0.433	No
RF Exposure Conditions	Test Position	Simultaneous Transmission Scenario			Σ1-g SAR (W/kg)	SPLSR (Yes/No)
		LTE Band 4	5.8GHz Wi-Fi Band	Bluetooth		
Body-worn	Rear	0.048	0.096	0.082	0.226	No
	Front	0.535	0.309	0.082	0.926	No
	Edge 1	--	--	0.082	0.082	No
	Edge 2	0.052	0.134	0.082	0.268	No
	Edge 3	1.306	--	0.082	1.388	No
	Edge 4	0.351	--	0.082	0.433	No

**Note:**

- According to KDB 447498 D01 General RF Exposure Guidance, when the simultaneous transmission SAR is less than 1.6 W/kg, SPLSR assessment is not required.
- SPLSR mean is "The SAR to Peak Location Separation Ratio "

Any report having not been signed by authorized approver, or having been altered without authorization, or having not been stamped by the "Dedicated Testing/Inspection Stamp" is deemed to be invalid. Copying or excerpting portion of, or altering the content of the report is not permitted without the written authorization of AGC. The test results presented in the report apply only to the tested sample. Any objections to report issued by AGC should be submitted to AGC within 15 days after the issuance of the test report. Further enquiry of validity or verification of the test report should be addressed to AGC by agc01@agccert.com.

**Sum of the SAR for LTE Band 5 & Wi-Fi & BT:**

RF Exposure Conditions	Test Position	Simultaneous Transmission Scenario			Σ1-g SAR (W/kg)	SPLSR (Yes/No)
		LTE Band 5	Wi-Fi DTS Band	Bluetooth		
Body-worn	Rear	0.234	0.087	0.082	0.403	No
	Front	0.588	0.291	0.082	0.961	No
	Edge 1	--	--	0.082	0.082	No
	Edge 2	0.644	0.377	0.082	1.103	No
	Edge 3	1.364	--	0.082	1.446	No
	Edge 4	0.152	--	0.082	0.234	No
RF Exposure Conditions	Test Position	Simultaneous Transmission Scenario			Σ1-g SAR (W/kg)	SPLSR (Yes/No)
		LTE Band 5	5.2GHz Wi-Fi Band	Bluetooth		
Body-worn	Rear	0.234	0.092	0.082	0.408	No
	Front	0.588	0.350	0.082	1.020	No
	Edge 1	--	--	0.082	0.082	No
	Edge 2	0.644	0.241	0.082	0.967	No
	Edge 3	1.364	--	0.082	1.446	No
	Edge 4	0.152	--	0.082	0.234	No
RF Exposure Conditions	Test Position	Simultaneous Transmission Scenario			Σ1-g SAR (W/kg)	SPLSR (Yes/No)
		LTE Band 5	5.3GHz Wi-Fi Band	Bluetooth		
Body-worn	Rear	0.234	0.099	0.082	0.415	No
	Front	0.588	0.396	0.082	1.066	No
	Edge 1	--	--	0.082	0.082	No
	Edge 2	0.644	0.199	0.082	0.925	No
	Edge 3	1.364	--	0.082	1.446	No
	Edge 4	0.152	--	0.082	0.234	No
RF Exposure Conditions	Test Position	Simultaneous Transmission Scenario			Σ1-g SAR (W/kg)	SPLSR (Yes/No)
		LTE Band 5	5.6GHz Wi-Fi Band	Bluetooth		
Body-worn	Rear	0.234	0.116	0.082	0.432	No
	Front	0.588	0.376	0.082	1.046	No
	Edge 1	--	--	0.082	0.082	No
	Edge 2	0.644	0.276	0.082	1.002	No
	Edge 3	1.364	--	0.082	1.446	No
	Edge 4	0.152	--	0.082	0.234	No
RF Exposure Conditions	Test Position	Simultaneous Transmission Scenario			Σ1-g SAR (W/kg)	SPLSR (Yes/No)
		LTE Band 5	5.8GHz Wi-Fi Band	Bluetooth		
Body-worn	Rear	0.234	0.096	0.082	0.412	No
	Front	0.588	0.309	0.082	0.979	No
	Edge 1	--	--	0.082	0.082	No
	Edge 2	0.644	0.134	0.082	0.860	No
	Edge 3	1.364	--	0.082	1.446	No
	Edge 4	0.152	--	0.082	0.234	No

**Note:**

- According to KDB 447498 D01 General RF Exposure Guidance, when the simultaneous transmission SAR is less than 1.6 W/kg, SPLSR assessment is not required.
- SPLSR mean is "The SAR to Peak Location Separation Ratio "

Any report having not been signed by authorized approver, or having been altered without authorization, or having not been stamped by the "Dedicated Testing/Inspection Stamp" is deemed to be invalid. Copying or excerpting portion of, or altering the content of the report is not permitted without the written authorization of AGC. The test results presented in the report apply only to the tested sample. Any objections to report issued by AGC should be submitted to AGC within 15 days after the issuance of the test report. Further enquiry of validity or verification of the test report should be addressed to AGC by agc01@agccert.com.

**Sum of the SAR for LTE Band 12 & Wi-Fi & BT:**

RF Exposure Conditions	Test Position	Simultaneous Transmission Scenario			Σ1-g SAR (W/kg)	SPLSR (Yes/No)
		LTE Band 12	Wi-Fi DTS Band	Bluetooth		
Body-worn	Rear	0.127	0.087	0.082	0.296	No
	Front	0.535	0.291	0.082	0.908	No
	Edge 1	--	--	0.082	0.082	No
	Edge 2	0.789	0.377	0.082	1.248	No
	Edge 3	1.277	--	0.082	1.359	No
	Edge 4	0.262	--	0.082	0.344	No
RF Exposure Conditions	Test Position	Simultaneous Transmission Scenario			Σ1-g SAR (W/kg)	SPLSR (Yes/No)
		LTE Band 12	5.2GHz Wi-Fi Band	Bluetooth		
Body-worn	Rear	0.127	0.092	0.082	0.301	No
	Front	0.535	0.350	0.082	0.967	No
	Edge 1	--	--	0.082	0.082	No
	Edge 2	0.789	0.241	0.082	1.112	No
	Edge 3	1.277	--	0.082	1.359	No
	Edge 4	0.262	--	0.082	0.344	No
RF Exposure Conditions	Test Position	Simultaneous Transmission Scenario			Σ1-g SAR (W/kg)	SPLSR (Yes/No)
		LTE Band 12	5.3GHz Wi-Fi Band	Bluetooth		
Body-worn	Rear	0.127	0.099	0.082	0.308	No
	Front	0.535	0.396	0.082	1.013	No
	Edge 1	--	--	0.082	0.082	No
	Edge 2	0.789	0.199	0.082	1.070	No
	Edge 3	1.277	--	0.082	1.359	No
	Edge 4	0.262	--	0.082	0.344	No
RF Exposure Conditions	Test Position	Simultaneous Transmission Scenario			Σ1-g SAR (W/kg)	SPLSR (Yes/No)
		LTE Band 12	5.6GHz Wi-Fi Band	Bluetooth		
Body-worn	Rear	0.127	0.116	0.082	0.325	No
	Front	0.535	0.376	0.082	0.993	No
	Edge 1	--	--	0.082	0.082	No
	Edge 2	0.789	0.276	0.082	1.147	No
	Edge 3	1.277	--	0.082	1.359	No
	Edge 4	0.262	--	0.082	0.344	No
RF Exposure Conditions	Test Position	Simultaneous Transmission Scenario			Σ1-g SAR (W/kg)	SPLSR (Yes/No)
		LTE Band 12	5.8GHz Wi-Fi Band	Bluetooth		
Body-worn	Rear	0.127	0.096	0.082	0.305	No
	Front	0.535	0.309	0.082	0.926	No
	Edge 1	--	--	0.082	0.082	No
	Edge 2	0.789	0.134	0.082	1.005	No
	Edge 3	1.277	--	0.082	1.359	No
	Edge 4	0.262	--	0.082	0.344	No

**Note:**

- According to KDB 447498 D01 General RF Exposure Guidance, when the simultaneous transmission SAR is less than 1.6 W/kg, SPLSR assessment is not required.
- SPLSR mean is “The SAR to Peak Location Separation Ratio “

Any report having not been signed by authorized approver, or having been altered without authorization, or having not been stamped by the “Dedicated Testing/Inspection Stamp” is deemed to be invalid. Copying or excerpting portion of, or altering the content of the report is not permitted without the written authorization of AGC. The test results presented in the report apply only to the tested sample. Any objections to report issued by AGC should be submitted to AGC within 15 days after the issuance of the test report. Further enquiry of validity or verification of the test report should be addressed to AGC by agc01@agccert.com.



**Sum of the SAR for LTE Band 13 & Wi-Fi & BT:**

RF Exposure Conditions	Test Position	Simultaneous Transmission Scenario			Σ1-g SAR (W/kg)	SPLSR (Yes/No)
		LTE Band 13	Wi-Fi DTS Band	Bluetooth		
Body-worn	Rear	0.298	0.087	0.082	0.467	No
	Front	0.589	0.291	0.082	0.962	No
	Edge 1	--	--	0.082	0.082	No
	Edge 2	0.730	0.377	0.082	1.189	No
	Edge 3	1.339	--	0.082	1.421	No
	Edge 4	0.367	--	0.082	0.449	No
RF Exposure Conditions	Test Position	Simultaneous Transmission Scenario			Σ1-g SAR (W/kg)	SPLSR (Yes/No)
		LTE Band 13	5.2GHz Wi-Fi Band	Bluetooth		
Body-worn	Rear	0.298	0.092	0.082	0.472	No
	Front	0.589	0.350	0.082	1.021	No
	Edge 1	--	--	0.082	0.082	No
	Edge 2	0.730	0.241	0.082	1.053	No
	Edge 3	1.339	--	0.082	1.421	No
	Edge 4	0.367	--	0.082	0.449	No
RF Exposure Conditions	Test Position	Simultaneous Transmission Scenario			Σ1-g SAR (W/kg)	SPLSR (Yes/No)
		LTE Band 13	5.3GHz Wi-Fi Band	Bluetooth		
Body-worn	Rear	0.298	0.099	0.082	0.479	No
	Front	0.589	0.396	0.082	1.067	No
	Edge 1	--	--	0.082	0.082	No
	Edge 2	0.730	0.199	0.082	1.011	No
	Edge 3	1.339	--	0.082	1.421	No
	Edge 4	0.367	--	0.082	0.449	No
RF Exposure Conditions	Test Position	Simultaneous Transmission Scenario			Σ1-g SAR (W/kg)	SPLSR (Yes/No)
		LTE Band 13	5.6GHz Wi-Fi Band	Bluetooth		
Body-worn	Rear	0.298	0.116	0.082	0.496	No
	Front	0.589	0.376	0.082	1.047	No
	Edge 1	--	--	0.082	0.082	No
	Edge 2	0.730	0.276	0.082	1.088	No
	Edge 3	1.339	--	0.082	1.421	No
	Edge 4	0.367	--	0.082	0.449	No
RF Exposure Conditions	Test Position	Simultaneous Transmission Scenario			Σ1-g SAR (W/kg)	SPLSR (Yes/No)
		LTE Band 13	5.8GHz Wi-Fi Band	Bluetooth		
Body-worn	Rear	0.298	0.096	0.082	0.476	No
	Front	0.589	0.309	0.082	0.980	No
	Edge 1	--	--	0.082	0.082	No
	Edge 2	0.730	0.134	0.082	0.946	No
	Edge 3	1.339	--	0.082	1.421	No
	Edge 4	0.367	--	0.082	0.449	No

**Note:**

- According to KDB 447498 D01 General RF Exposure Guidance, when the simultaneous transmission SAR is less than 1.6 W/kg, SPLSR assessment is not required.
- SPLSR mean is "The SAR to Peak Location Separation Ratio"

Any report having not been signed by authorized approver, or having been altered without authorization, or having not been stamped by the "Dedicated Testing/Inspection Stamp" is deemed to be invalid. Copying or excerpting portion of, or altering the content of the report is not permitted without the written authorization of AGC. The test results presented in the report apply only to the tested sample. Any objections to report issued by AGC should be submitted to AGC within 15 days after the issuance of the test report. Further enquiry of validity or verification of the test report should be addressed to AGC by agc01@agccert.com.

**Sum of the SAR for LTE Band 14 & Wi-Fi & BT:**

RF Exposure Conditions	Test Position	Simultaneous Transmission Scenario			Σ1-g SAR (W/kg)	SPLSR (Yes/No)
		LTE Band 14	Wi-Fi DTS Band	Bluetooth		
Body-worn	Rear	0.369	0.087	0.082	0.538	No
	Front	0.583	0.291	0.082	0.956	No
	Edge 1	--	--	0.082	0.191	No
	Edge 2	0.723	0.377	0.082	1.182	No
	Edge 3	1.277	--	0.082	1.359	No
	Edge 4	0.316	--	0.082	0.463	No
RF Exposure Conditions	Test Position	Simultaneous Transmission Scenario			Σ1-g SAR (W/kg)	SPLSR (Yes/No)
		LTE Band 14	5.2GHz Wi-Fi Band	Bluetooth		
Body-worn	Rear	0.369	0.092	0.082	0.543	No
	Front	0.583	0.350	0.082	1.015	No
	Edge 1	--	--	0.082	0.082	No
	Edge 2	0.723	0.241	0.082	1.046	No
	Edge 3	1.277	--	0.082	1.359	No
	Edge 4	0.316	--	0.082	0.398	No
RF Exposure Conditions	Test Position	Simultaneous Transmission Scenario			Σ1-g SAR (W/kg)	SPLSR (Yes/No)
		LTE Band 14	5.3GHz Wi-Fi Band	Bluetooth		
Body-worn	Rear	0.369	0.099	0.082	0.550	No
	Front	0.583	0.396	0.082	1.061	No
	Edge 1	--	--	0.082	0.082	No
	Edge 2	0.723	0.199	0.082	1.004	No
	Edge 3	1.277	--	0.082	1.359	No
	Edge 4	0.316	--	0.082	0.398	No
RF Exposure Conditions	Test Position	Simultaneous Transmission Scenario			Σ1-g SAR (W/kg)	SPLSR (Yes/No)
		LTE Band 14	5.6GHz Wi-Fi Band	Bluetooth		
Body-worn	Rear	0.369	0.116	0.082	0.567	No
	Front	0.583	0.376	0.082	1.041	No
	Edge 1	--	--	0.082	0.082	No
	Edge 2	0.723	0.276	0.082	1.081	No
	Edge 3	1.277	--	0.082	1.359	No
	Edge 4	0.316	--	0.082	0.398	No
RF Exposure Conditions	Test Position	Simultaneous Transmission Scenario			Σ1-g SAR (W/kg)	SPLSR (Yes/No)
		LTE Band 14	5.8GHz Wi-Fi Band	Bluetooth		
Body-worn	Rear	0.369	0.096	0.082	0.547	No
	Front	0.583	0.309	0.082	0.974	No
	Edge 1	--	--	0.082	0.082	No
	Edge 2	0.723	0.134	0.082	0.939	No
	Edge 3	1.277	--	0.082	1.359	No
	Edge 4	0.316	--	0.082	0.398	No

**Note:**

- According to KDB 447498 D01 General RF Exposure Guidance, when the simultaneous transmission SAR is less than 1.6 W/kg, SPLSR assessment is not required.
- SPLSR mean is "The SAR to Peak Location Separation Ratio"

Any report having not been signed by authorized approver, or having been altered without authorization, or having not been stamped by the "Dedicated Testing/Inspection Stamp" is deemed to be invalid. Copying or excerpting portion of, or altering the content of the report is not permitted without the written authorization of AGC. The test results presented in the report apply only to the tested sample. Any objections to report issued by AGC should be submitted to AGC within 15 days after the issuance of the test report. Further enquiry of validity or verification of the test report should be addressed to AGC by agc01@agccert.com.

**Sum of the SAR for LTE Band 66 & Wi-Fi & BT:**

RF Exposure Conditions	Test Position	Simultaneous Transmission Scenario			Σ1-g SAR (W/kg)	SPLSR (Yes/No)
		LTE Band 66	Wi-Fi DTS Band	Bluetooth		
Body-worn	Rear	0.043	0.087	0.082	0.212	No
	Front	0.424	0.291	0.082	0.797	No
	Edge 1	--	--	0.082	0.082	No
	Edge 2	0.045	0.377	0.082	0.504	No
	Edge 3	1.304	--	0.082	1.386	No
	Edge 4	0.301	--	0.082	0.383	No
RF Exposure Conditions	Test Position	Simultaneous Transmission Scenario			Σ1-g SAR (W/kg)	SPLSR (Yes/No)
		LTE Band 66	5.2GHz Wi-Fi Band	Bluetooth		
Body-worn	Rear	0.043	0.092	0.082	0.217	No
	Front	0.424	0.350	0.082	0.856	No
	Edge 1	--	--	0.082	0.082	No
	Edge 2	0.045	0.241	0.082	0.368	No
	Edge 3	1.304	--	0.082	1.386	No
	Edge 4	0.301	--	0.082	0.383	No
RF Exposure Conditions	Test Position	Simultaneous Transmission Scenario			Σ1-g SAR (W/kg)	SPLSR (Yes/No)
		LTE Band 66	5.3GHz Wi-Fi Band	Bluetooth		
Body-worn	Rear	0.043	0.099	0.082	0.224	No
	Front	0.424	0.396	0.082	0.902	No
	Edge 1	--	--	0.082	0.082	No
	Edge 2	0.045	0.199	0.082	0.326	No
	Edge 3	1.304	--	0.082	1.386	No
	Edge 4	0.301	--	0.082	0.383	No
RF Exposure Conditions	Test Position	Simultaneous Transmission Scenario			Σ1-g SAR (W/kg)	SPLSR (Yes/No)
		LTE Band 66	5.6GHz Wi-Fi Band	Bluetooth		
Body-worn	Rear	0.043	0.116	0.082	0.241	No
	Front	0.424	0.376	0.082	0.882	No
	Edge 1	--	--	0.082	0.082	No
	Edge 2	0.045	0.276	0.082	0.403	No
	Edge 3	1.304	--	0.082	1.386	No
	Edge 4	0.301	--	0.082	0.383	No
RF Exposure Conditions	Test Position	Simultaneous Transmission Scenario			Σ1-g SAR (W/kg)	SPLSR (Yes/No)
		LTE Band 66	5.8GHz Wi-Fi Band	Bluetooth		
Body-worn	Rear	0.043	0.096	0.082	0.221	No
	Front	0.424	0.309	0.082	0.815	No
	Edge 1	--	--	0.082	0.082	No
	Edge 2	0.045	0.134	0.082	0.261	No
	Edge 3	1.304	--	0.082	1.386	No
	Edge 4	0.301	--	0.082	0.383	No

**Note:**

- According to KDB 447498 D01 General RF Exposure Guidance, when the simultaneous transmission SAR is less than 1.6 W/kg, SPLSR assessment is not required.
- SPLSR mean is "The SAR to Peak Location Separation Ratio"

Any report having not been signed by authorized approver, or having been altered without authorization, or having not been stamped by the "Dedicated Testing/Inspection Stamp" is deemed to be invalid. Copying or excerpting portion of, or altering the content of the report is not permitted without the written authorization of AGC. The test results presented in the report apply only to the tested sample. Any objections to report issued by AGC should be submitted to AGC within 15 days after the issuance of the test report. Further enquiry of validity or verification of the test report should be addressed to AGC by agc01@agccert.com.

**Sum of the SAR for LTE Band 71 & Wi-Fi & BT:**

RF Exposure Conditions	Test Position	Simultaneous Transmission Scenario			Σ1-g SAR (W/kg)	SPLSR (Yes/No)
		LTE Band 71	Wi-Fi DTS Band	Bluetooth		
Body-worn	Rear	0.085	0.087	0.082	0.254	No
	Front	0.638	0.291	0.082	1.011	No
	Edge 1	--	--	0.082	0.082	No
	Edge 2	0.618	0.377	0.082	1.077	No
	Edge 3	1.350	--	0.082	1.432	No
	Edge 4	0.170	--	0.082	0.252	No
RF Exposure Conditions	Test Position	Simultaneous Transmission Scenario			Σ1-g SAR (W/kg)	SPLSR (Yes/No)
		LTE Band 71	5.2GHz Wi-Fi Band	Bluetooth		
Body-worn	Rear	0.085	0.092	0.082	0.259	No
	Front	0.638	0.350	0.082	1.070	No
	Edge 1	--	--	0.082	0.082	No
	Edge 2	0.618	0.241	0.082	0.941	No
	Edge 3	1.350	--	0.082	1.432	No
	Edge 4	0.170	--	0.082	0.252	No
RF Exposure Conditions	Test Position	Simultaneous Transmission Scenario			Σ1-g SAR (W/kg)	SPLSR (Yes/No)
		LTE Band 71	5.3GHz Wi-Fi Band	Bluetooth		
Body-worn	Rear	0.085	0.099	0.082	0.266	No
	Front	0.638	0.396	0.082	1.116	No
	Edge 1	--	--	0.082	0.082	No
	Edge 2	0.618	0.199	0.082	0.899	No
	Edge 3	1.350	--	0.082	1.432	No
	Edge 4	0.170	--	0.082	0.252	No
RF Exposure Conditions	Test Position	Simultaneous Transmission Scenario			Σ1-g SAR (W/kg)	SPLSR (Yes/No)
		LTE Band 71	5.6GHz Wi-Fi Band	Bluetooth		
Body-worn	Rear	0.085	0.116	0.082	0.283	No
	Front	0.638	0.376	0.082	1.096	No
	Edge 1	--	--	0.082	0.082	No
	Edge 2	0.618	0.276	0.082	0.976	No
	Edge 3	1.350	--	0.082	1.432	No
	Edge 4	0.170	--	0.082	0.252	No
RF Exposure Conditions	Test Position	Simultaneous Transmission Scenario			Σ1-g SAR (W/kg)	SPLSR (Yes/No)
		LTE Band 71	5.8GHz Wi-Fi Band	Bluetooth		
Body-worn	Rear	0.085	0.096	0.082	0.263	No
	Front	0.638	0.309	0.082	1.029	No
	Edge 1	--	--	0.082	0.082	No
	Edge 2	0.618	0.134	0.082	0.834	No
	Edge 3	1.350	--	0.082	1.432	No
	Edge 4	0.170	--	0.082	0.252	No

**Note:**

- According to KDB 447498 D01 General RF Exposure Guidance, when the simultaneous transmission SAR is less than 1.6 W/kg, SPLSR assessment is not required.
- SPLSR mean is "The SAR to Peak Location Separation Ratio "

Any report having not been signed by authorized approver, or having been altered without authorization, or having not been stamped by the "Dedicated Testing/Inspection Stamp" is deemed to be invalid. Copying or excerpting portion of, or altering the content of the report is not permitted without the written authorization of AGC. The test results presented in the report apply only to the tested sample. Any objections to report issued by AGC should be submitted to AGC within 15 days after the issuance of the test report. Further enquiry of validity or verification of the test report should be addressed to AGC by agc01@agccert.com.

## APPENDIX A. SAR SYSTEM CHECK DATA

Test Laboratory: AGC Lab

Date: Dec. 09, 2023

System Check Head 750 MHz

DUT: Dipole 750 MHz Type: SID 750

Communication System CW; Communication System Band: D750 (750.0 MHz); Duty Cycle: 1:1; Conv.F=1.95

Frequency: 750 MHz; Medium parameters used:  $f = 750$  MHz;  $\sigma=0.87$  mho/m;  $\epsilon_r = 40.13$ ;  $\rho = 1000$  kg/m<sup>3</sup> ;

Phantom section: Flat Section; Input Power=18dBm

Ambient temperature (°C):20.8, Liquid temperature (°C): 20.5

SATIMO Configuration:

Probe: SSE2; Calibrated: May 31, 2023; Serial No.: 2023-EPGO-414

Sensor-Surface: 4mm (Mechanical Surface Detection)

Phantom: SAM twin phantom

Measurement SW: OpenSAR V4\_02\_32

Configuration/System Check 750MHz Head/Area Scan: Measurement grid: dx=8mm, dy=8mm

Configuration/System Check 750MHz Head/Zoom Scan: Measurement grid: dx=8mm,dy=8mm, dz=5mm

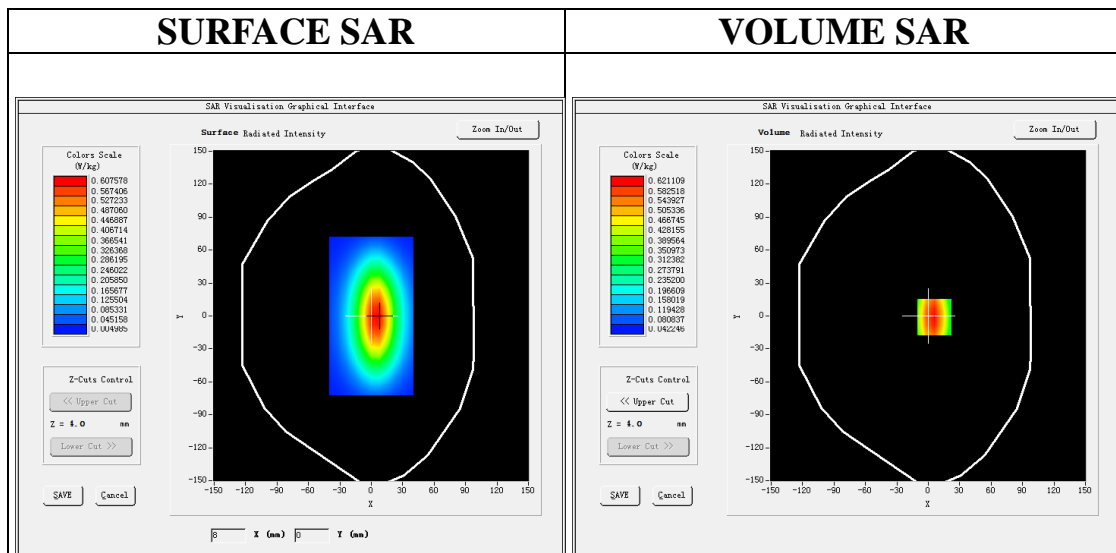

**Maximum location: X=6.00, Y=-1.00**

**SAR Peak: 0.88 W/kg**

<b>SAR 10g (W/Kg)</b>	0.356028
<b>SAR 1g (W/Kg)</b>	0.564912

Z (mm)	0.00	4.00	9.00	14.00	19.00	24.00	29.00
<b>SAR (W/Kg)</b>	<b>0.8867</b>	<b>0.6205</b>	<b>0.3971</b>	<b>0.2623</b>	<b>0.1759</b>	<b>0.1201</b>	<b>0.0818</b>

Any report having not been signed by authorized approver, or having been altered without authorization, or having not been stamped by the "Dedicated Testing/Inspection Stamp" is deemed to be invalid. Copying or excerpting portion of, or altering the content of the report is not permitted without the written authorization of AGC. The test results presented in the report apply only to the tested sample. Any objections to report issued by AGC should be submitted to AGC within 15days after the issuance of the test report. Further enquiry of validity or verification of the test report should be addressed to AGC by agc01@agccert.com.

Attestation of Global Compliance(Shenzhen)Co., Ltd

Attestation of Global Compliance(Shenzhen)Std & Tech Co., Ltd

Tel: +86-755 2523 4088 E-mail: agc@agccert.com Web: http://www.agccert.com/

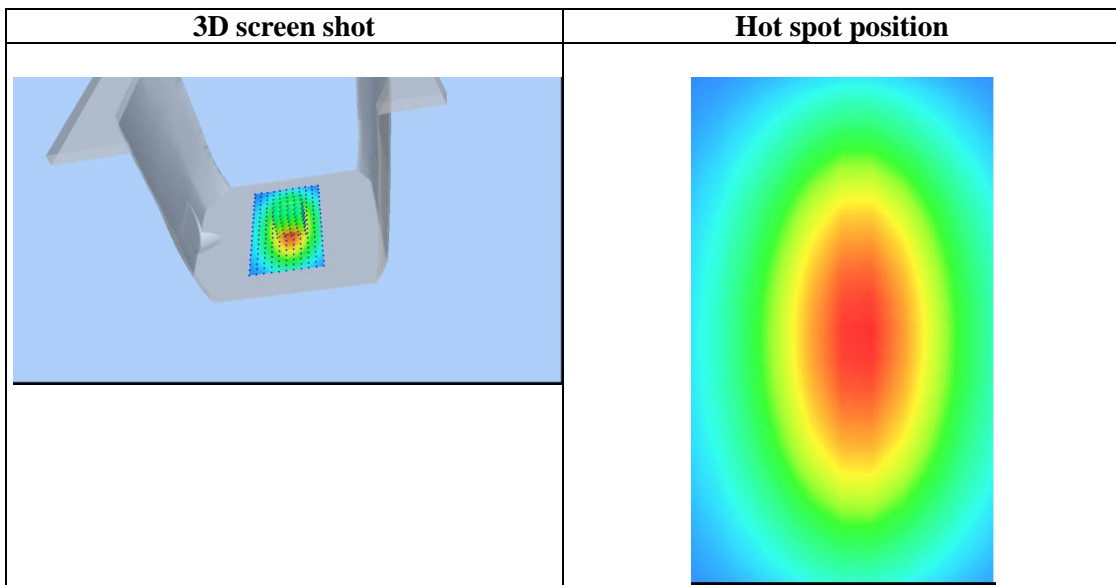
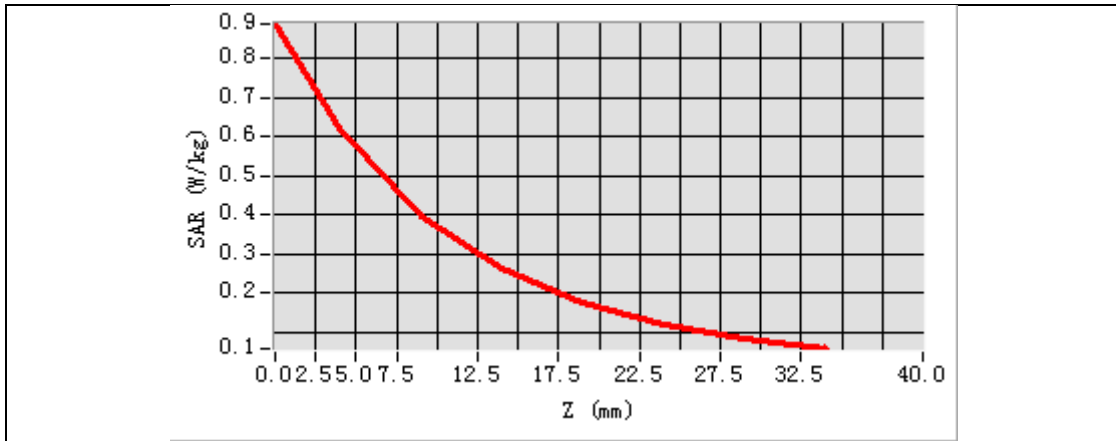

Any report having not been signed by authorized approver, or having been altered without authorization, or having not been stamped by the “Dedicated Testing/Inspection Stamp” is deemed to be invalid. Copying or excerpting portion of, or altering the content of the report is not permitted without the written authorization of AGC. The test results presented in the report apply only to the tested sample. Any objections to report issued by AGC should be submitted to AGC within 15days after the issuance of the test report. Further enquiry of validity or verification of the test report should be addressed to AGC by agc01@agccert.com.

**Test Laboratory: AGC Lab**  
**System Check Head 835 MHz**

**Date: Dec. 05, 2023**

**DUT: Dipole 835 MHz Type: SID 835**

Communication System CW; Communication System Band: D835 (835.0 MHz); Duty Cycle: 1:1; Conv.F=2.02  
Frequency: 835 MHz; Medium parameters used:  $f = 835$  MHz;  $\sigma=0.91$  mho/m;  $\epsilon_r = 41.28$ ;  $\rho = 1000$  kg/m<sup>3</sup> ;  
Phantom section: Flat Section; Input Power=18dBm  
Ambient temperature (°C):22.4, Liquid temperature (°C): 21.7

**SATIMO Configuration:**

Probe: SSE2; Calibrated: May 31, 2023; Serial No.: 2023-EPGO-414  
Sensor-Surface: 4mm (Mechanical Surface Detection)  
Phantom: SAM twin phantom  
Measurement SW: OpenSAR V4\_02\_32

**Configuration/System Check 835MHz Head/Area Scan:** Measurement grid: dx=8mm, dy=8mm

**Configuration/System Check 835MHz Head/Zoom Scan:** Measurement grid: dx=8mm,dy=8mm, dz=5mm

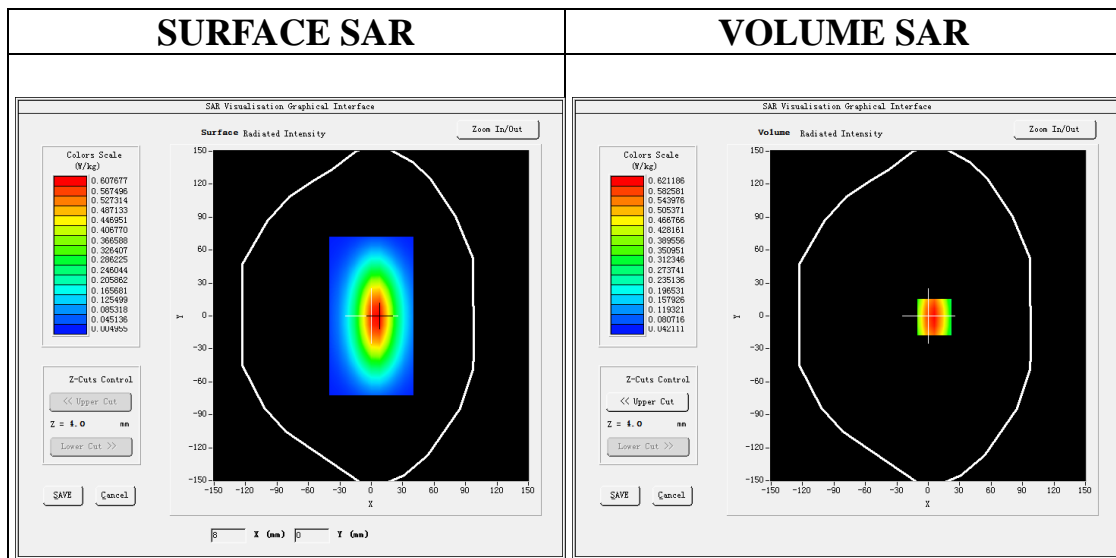

**Maximum location: X=6.00, Y=-1.00**  
**SAR Peak: 0.89 W/kg**

<b>SAR 10g (W/Kg)</b>	0.387524
<b>SAR 1g (W/Kg)</b>	0.606385

Any report having not been signed by authorized approver, or having been altered without authorization, or having not been stamped by the “Dedicated Testing/Inspection Stamp” is deemed to be invalid. Copying or excerpting portion of, or altering the content of the report is not permitted without the written authorization of AGC. The test results presented in the report apply only to the tested sample. Any objections to report issued by AGC should be submitted to AGC within 15days after the issuance of the test report. Further enquiry of validity or verification of the test report should be addressed to AGC by agc01@agccert.com.

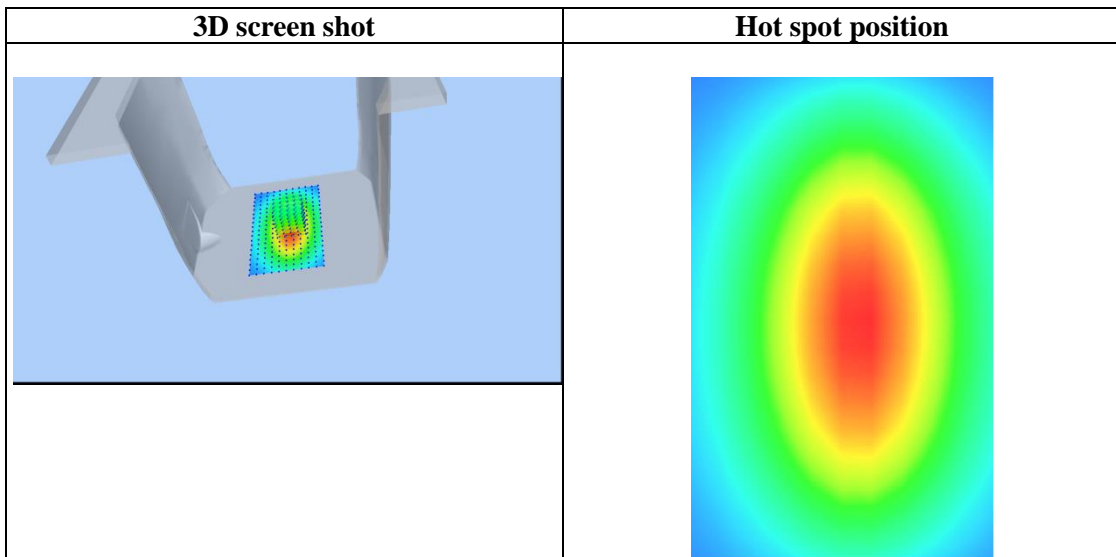
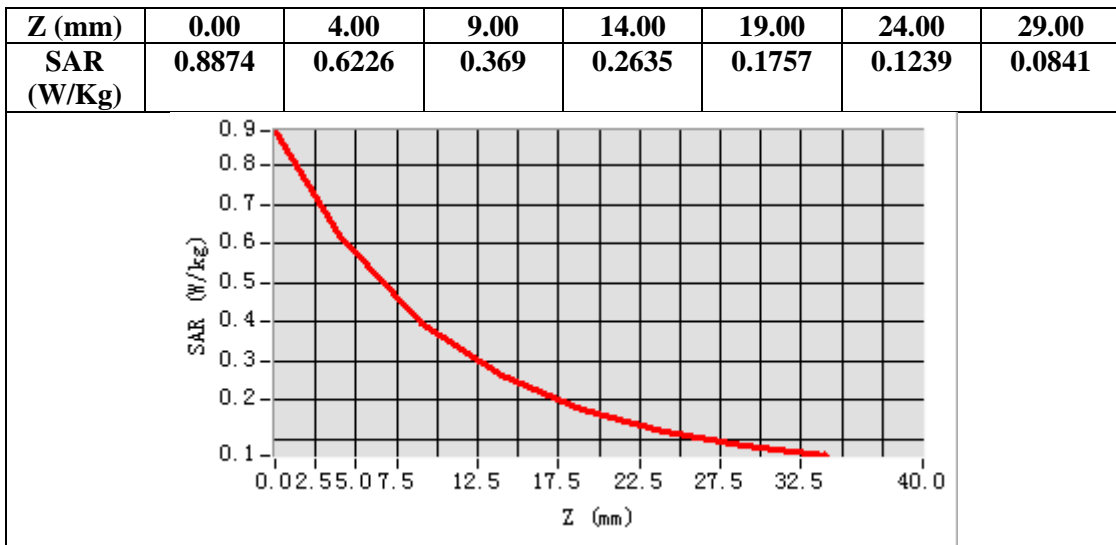

Any report having not been signed by authorized approver, or having been altered without authorization, or having not been stamped by the “Dedicated Testing/Inspection Stamp” is deemed to be invalid. Copying or excerpting portion of, or altering the content of the report is not permitted without the written authorization of AGC. The test results presented in the report apply only to the tested sample. Any objections to report issued by AGC should be submitted to AGC within 15days after the issuance of the test report. Further enquiry of validity or verification of the test report should be addressed to AGC by agc01@agccert.com.



**Test Laboratory: AGC Lab**  
**System Check Head 1750MHz**

**Date: Dec. 20, 2023**

**DUT: Dipole 1800 MHz; Type: SID 1800**

Communication System: CW; Communication System Band: D1700 (1750.0 MHz); Duty Cycle:1:1; Conv.F=2.17  
Frequency: 1750 MHz; Medium parameters used:  $f = 1750\text{MHz}$ ;  $\sigma = 1.41 \text{ mho/m}$ ;  $\epsilon_r = 39.45$ ;  $\rho = 1000 \text{ kg/m}^3$  ;  
Phantom section: Flat Section; Input Power=18dBm  
Ambient temperature ( $^{\circ}\text{C}$ ): 21.7, Liquid temperature ( $^{\circ}\text{C}$ ): 21.2

SATIMO Configuration:

Probe: SSE2; Calibrated: May 31, 2023; Serial No.: 2023-EPGO-414

Sensor-Surface: 4mm (Mechanical Surface Detection)

Phantom: SAM twin phantom

Measurement SW: OpenSAR V4\_02\_32

**Configuration/System Check 1750MHz Head/Area Scan:** Measurement grid:  $dx=8\text{mm}, dy=8\text{mm}$

**Configuration/System Check 1750MHz Head/Zoom Scan:** Measurement grid:  $dx=8\text{mm}, dy=8\text{mm}, dz=5\text{mm}$

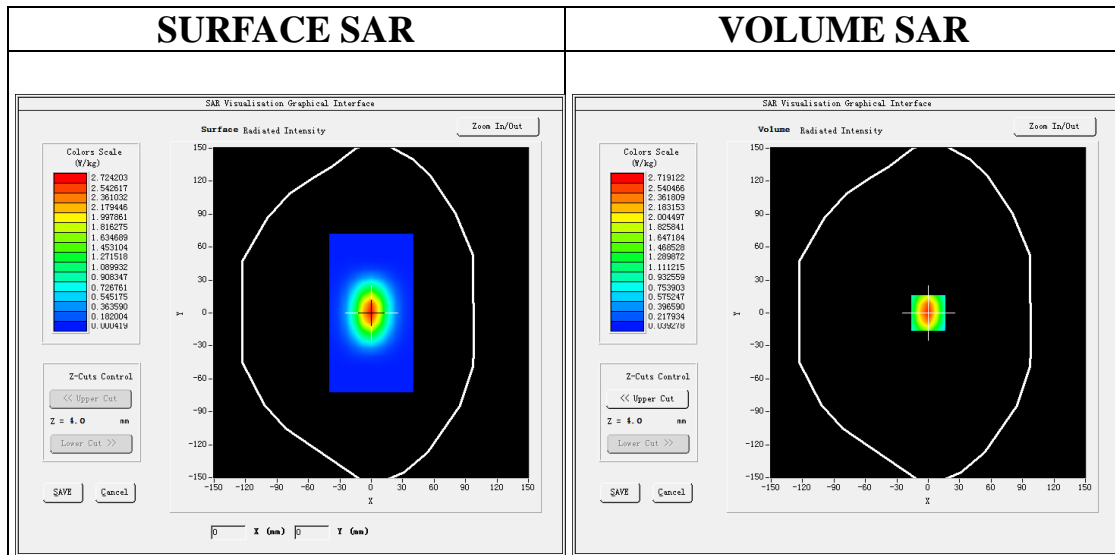

**Maximum location: X=0.00, Y=0.00**

**SAR Peak: 4.42 W/kg**

<b>SAR 10g (W/Kg)</b>	1.297581
<b>SAR 1g (W/Kg)</b>	2.562984

Any report having not been signed by authorized approver, or having been altered without authorization, or having not been stamped by the "Dedicated Testing/Inspection Stamp" is deemed to be invalid. Copying or excerpting portion of, or altering the content of the report is not permitted without the written authorization of AGC. The test results presented in the report apply only to the tested sample. Any objections to report issued by AGC should be submitted to AGC within 15days after the issuance of the test report. Further enquiry of validity or verification of the test report should be addressed to AGC by [agc01@agccert.com](mailto:agc01@agccert.com).

Attestation of Global Compliance(Shenzhen)Co., Ltd

Attestation of Global Compliance(Shenzhen)Std & Tech Co., Ltd

Tel: +86-755 2523 4088 E-mail: [agc@agccert.com](mailto:agc@agccert.com) Web: <http://www.agccert.com/>

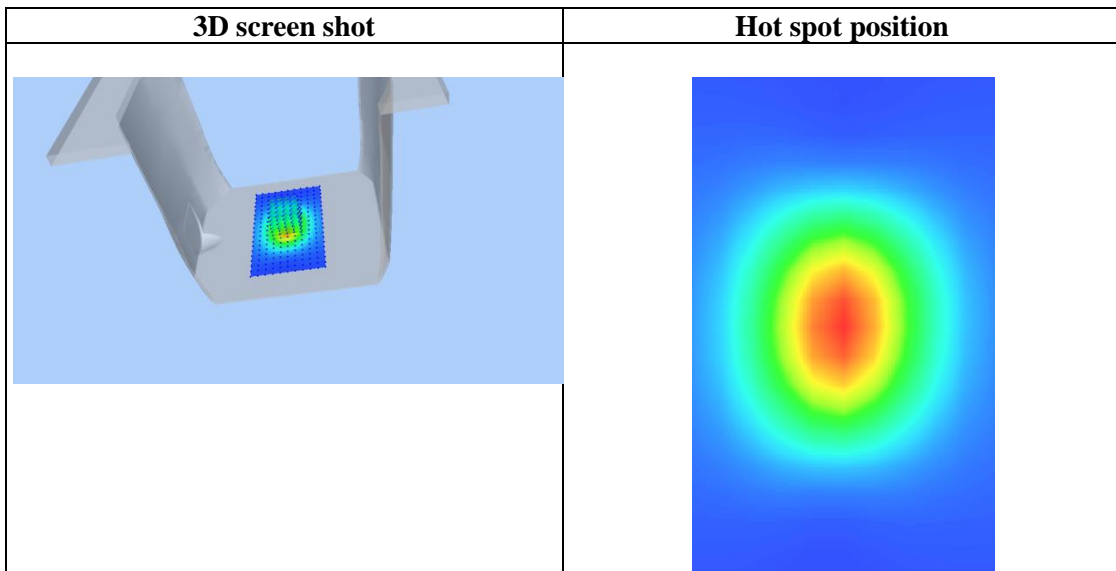
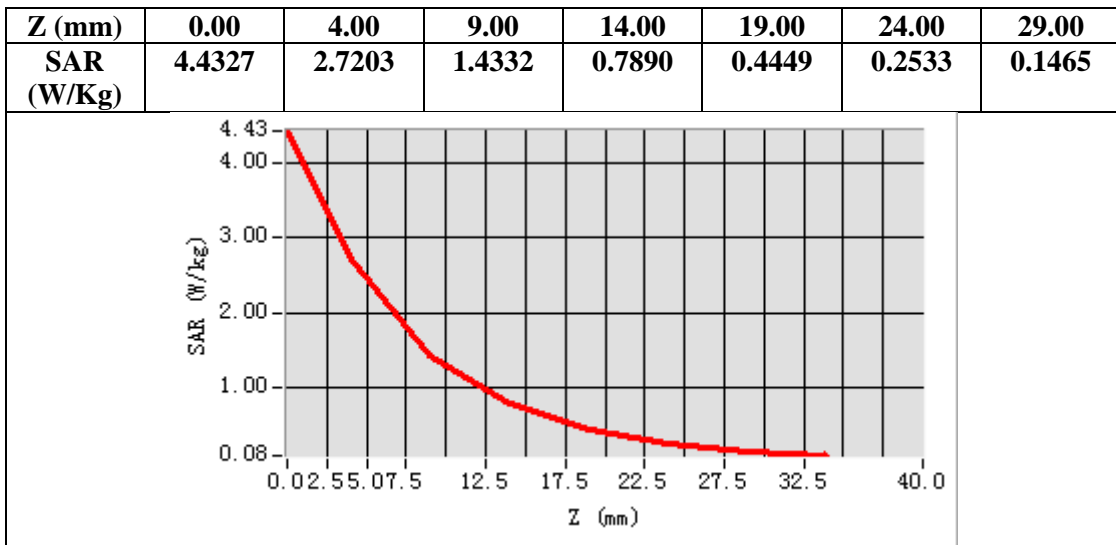

Any report having not been signed by authorized approver, or having been altered without authorization, or having not been stamped by the "Dedicated Testing/Inspection Stamp" is deemed to be invalid. Copying or excerpting portion of, or altering the content of the report is not permitted without the written authorization of AGC. The test results presented in the report apply only to the tested sample. Any objections to report issued by AGC should be submitted to AGC within 15days after the issuance of the test report. Further enquiry of validity or verification of the test report should be addressed to AGC by agc01@agccert.com.

**Test Laboratory: AGC Lab**  
**System Check Head 1900MHz**

**Date: Dec. 01, 2023**

**DUT: Dipole 1900 MHz; Type: SID 1900**

Communication System: CW; Communication System Band: D1900 (1900.0 MHz); Duty Cycle:1:1; Conv.F=2.15  
Frequency: 1900 MHz; Medium parameters used:  $f = 1900$  MHz;  $\sigma = 1.42$  mho/m;  $\epsilon_r = 39.09$ ;  $\rho = 1000$  kg/m<sup>3</sup> ;  
Phantom section: Flat Section; Input Power=18dBm  
Ambient temperature (°C):20.7, Liquid temperature (°C): 20.3

SATIMO Configuration:

Probe: SSE2; Calibrated: May 31, 2023; Serial No.: 2023-EPGO-414

Sensor-Surface: 4mm (Mechanical Surface Detection)

Phantom: SAM twin phantom

Measurement SW: OpenSAR V4\_02\_32

**Configuration/System Check 1900MHz Head/Area Scan:** Measurement grid: dx=8mm, dy=8mm

**Configuration/System Check 1900MHz Head/Zoom Scan:** Measurement grid: dx=8mm,dy=8mm, dz=5mm

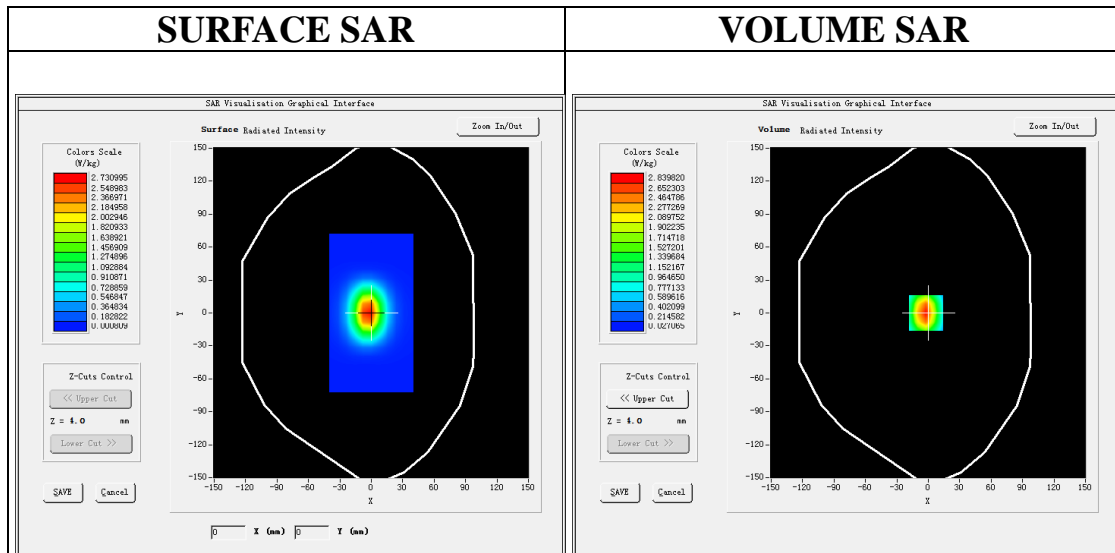

**Maximum location: X=-2.00, Y=0.00**

**SAR Peak: 4.71 W/kg**

<b>SAR 10g (W/Kg)</b>	1.297192
<b>SAR 1g (W/Kg)</b>	2.670842

Any report having not been signed by authorized approver, or having been altered without authorization, or having not been stamped by the "Dedicated Testing/Inspection Stamp" is deemed to be invalid. Copying or excerpting portion of, or altering the content of the report is not permitted without the written authorization of AGC. The test results presented in the report apply only to the tested sample. Any objections to report issued by AGC should be submitted to AGC within 15days after the issuance of the test report. Further enquiry of validity or verification of the test report should be addressed to AGC by agc01@agccert.com.

Attestation of Global Compliance(Shenzhen)Co., Ltd

Attestation of Global Compliance(Shenzhen)Std & Tech Co., Ltd

Tel: +86-755 2523 4088 E-mail: agc@agccert.com Web: http://www.agccert.com/

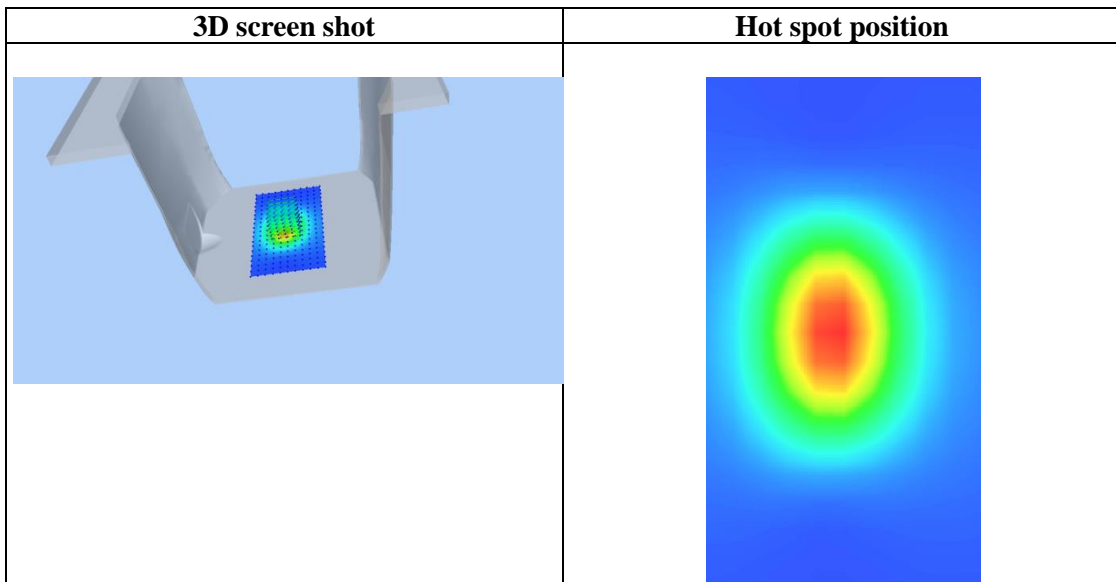
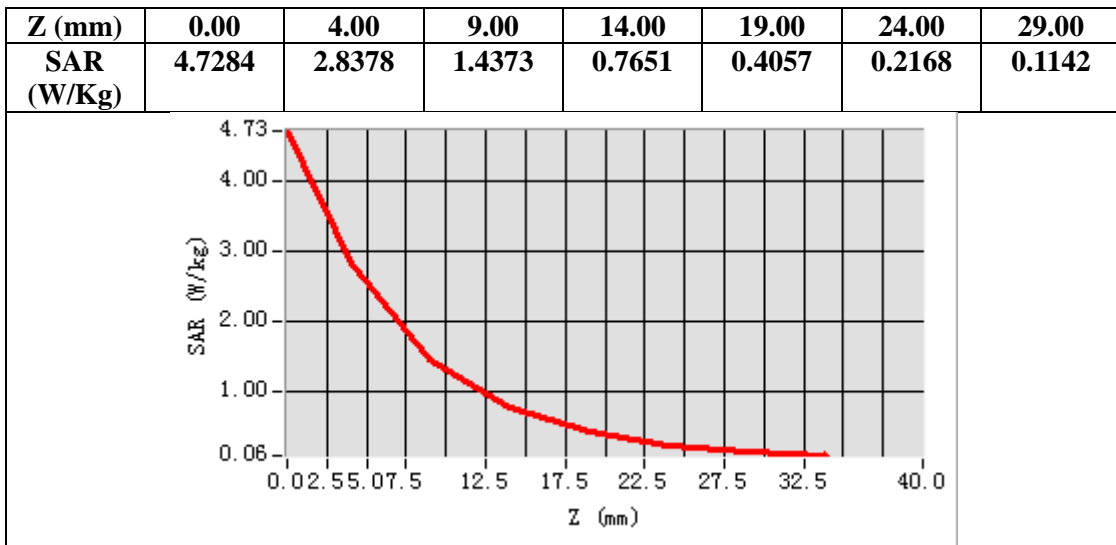

Any report having not been signed by authorized approver, or having been altered without authorization, or having not been stamped by the “Dedicated Testing/Inspection Stamp” is deemed to be invalid. Copying or excerpting portion of, or altering the content of the report is not permitted without the written authorization of AGC. The test results presented in the report apply only to the tested sample. Any objections to report issued by AGC should be submitted to AGC within 15days after the issuance of the test report. Further enquiry of validity or verification of the test report should be addressed to AGC by agc01@agccert.com.

**Test Laboratory: AGC Lab**  
**System Check Head 2450 MHz**

**Date: Dec. 22, 2023**

**DUT: Dipole 2450 MHz Type: SID 2450**

Communication System CW; Communication System Band: D2450 (2450.0 MHz); Duty Cycle: 1:1; Conv.F=2.29  
Frequency: 2450 MHz; Medium parameters used:  $f = 2450$  MHz;  $\sigma = 1.81$  mho/m;  $\epsilon_r = 39.47$ ;  $\rho = 1000$  kg/m<sup>3</sup> ;  
Phantom section: Flat Section; Input Power=18dBm  
Ambient temperature (°C):21.1, Liquid temperature (°C): 20.8

**SATIMO Configuration**

Probe: SSE2; Calibrated: May 31, 2023; Serial No.: 2023-EPGO-414  
Sensor-Surface: 4mm (Mechanical Surface Detection)  
Phantom: SAM twin phantom  
Measurement SW: OpenSAR V4\_02\_32

**Configuration/System Check 2450MHz Head/Area Scan:** Measurement grid: dx=8mm, dy=8mm

**Configuration/System Check 2450MHz Head/Zoom Scan:** Measurement grid: dx=5mm,dy=5mm, dz=5mm

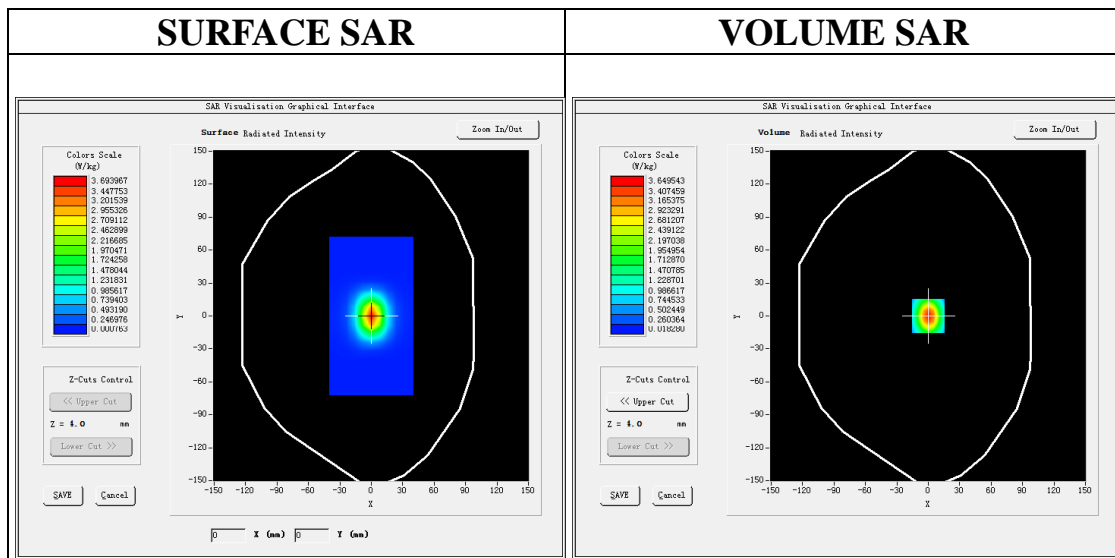

**Maximum location: X=0.00, Y=0.00**  
**SAR Peak: 6.27 W/kg**

<b>SAR 10g (W/Kg)</b>	1.494517
<b>SAR 1g (W/Kg)</b>	3.337029

Any report having not been signed by authorized approver, or having been altered without authorization, or having not been stamped by the “Dedicated Testing/Inspection Stamp” is deemed to be invalid. Copying or excerpting portion of, or altering the content of the report is not permitted without the written authorization of AGC. The test results presented in the report apply only to the tested sample. Any objections to report issued by AGC should be submitted to AGC within 15days after the issuance of the test report. Further enquiry of validity or verification of the test report should be addressed to AGC by agc01@agccert.com.

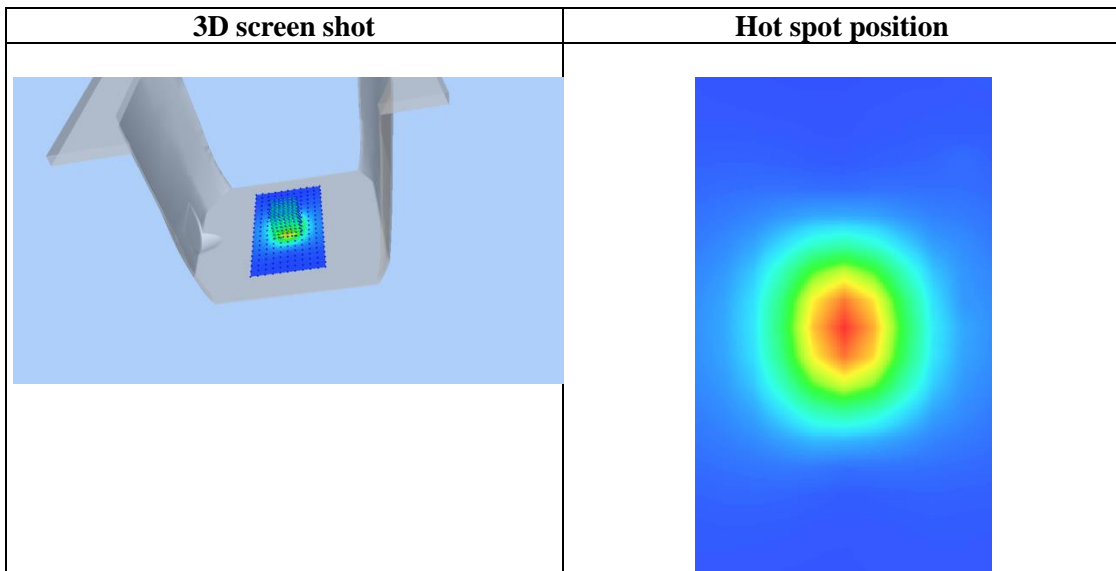
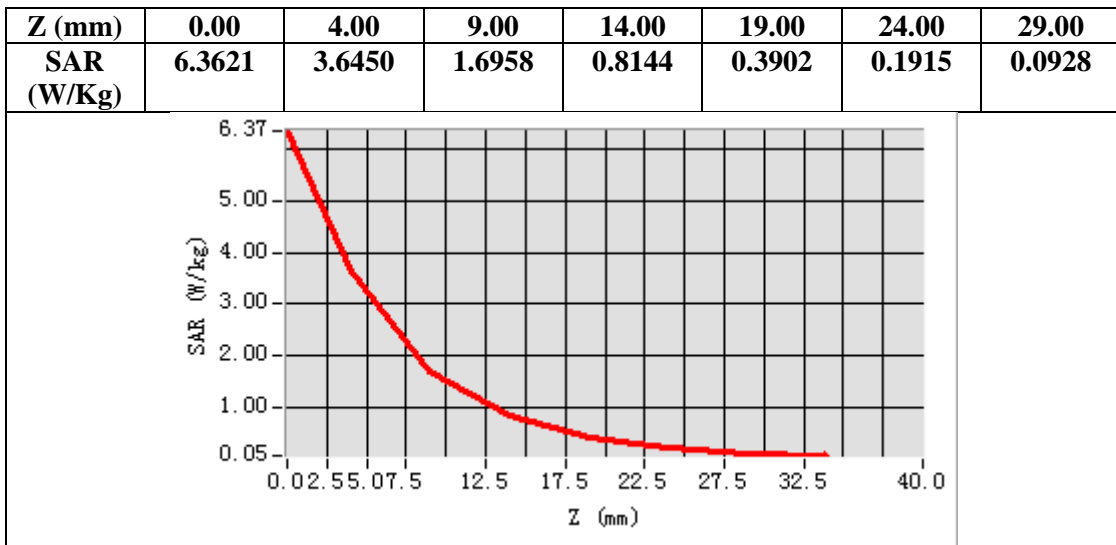

Any report having not been signed by authorized approver, or having been altered without authorization, or having not been stamped by the "Dedicated Testing/Inspection Stamp" is deemed to be invalid. Copying or excerpting portion of, or altering the content of the report is not permitted without the written authorization of AGC. The test results presented in the report apply only to the tested sample. Any objections to report issued by AGC should be submitted to AGC within 15days after the issuance of the test report. Further enquiry of validity or verification of the test report should be addressed to AGC by agc01@agccert.com.

**Test Laboratory: AGC Lab**  
**System Check 5200 MHz**

**Date: Dec. 13, 2023**

**DUT: Dipole 5000MHz Type: SID5500**

Communication System: CW; Communication System Band: D5000 (5000.0 MHz); Duty Cycle: 1:1; Conv.F=1.35  
Frequency: 5200 MHz; Medium parameters used:  $f = 5200$  MHz;  $\sigma = 4.50$  mho/m;  $\epsilon_r = 36.21$ ;  $\rho = 1000$  kg/m<sup>3</sup> ;  
Phantom section: Flat Section; Input Power=10dBm  
Ambient temperature (°C): 20.1, Liquid temperature (°C): 19.8

SATIMO Configuration:

- Probe: SSE2; Calibrated: May 31, 2023; Serial No.: 2023-EPGO-414
- Sensor-Surface: 4mm (Mechanical Surface Detection)
- Phantom: SAM twin phantom
- Measurement SW: OpenSAR V4\_02\_32

**Configuration/System Check 5200 MHz Body/Area Scan:** Measurement grid: dx=8mm, dy=8mm

**Configuration/System Check 5200 MHz Body/Zoom Scan:** Measurement grid: dx=4mm,dy=4mm, dz=2mm

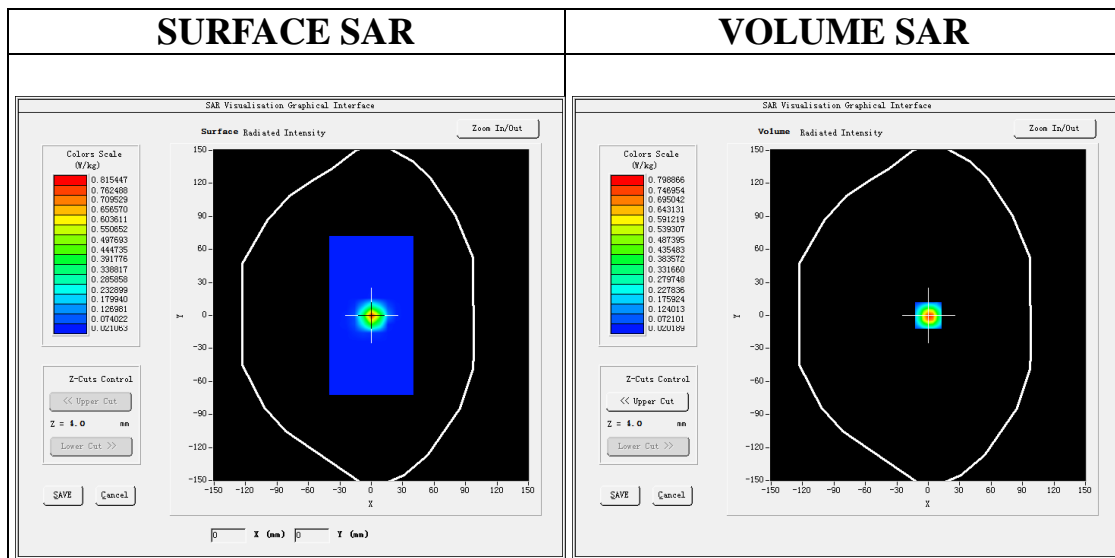

**Maximum location: X=0.00, Y=0.00**  
**SAR Peak: 2.24 W/kg**

<b>SAR 10g (W/Kg)</b>	0.212014
<b>SAR 1g (W/Kg)</b>	0.742209

Any report having not been signed by authorized approver, or having been altered without authorization, or having not been stamped by the “Dedicated Testing/Inspection Stamp” is deemed to be invalid. Copying or excerpting portion of, or altering the content of the report is not permitted without the written authorization of AGC. The test results presented in the report apply only to the tested sample. Any objections to report issued by AGC should be submitted to AGC within 15days after the issuance of the test report. Further enquiry of validity or verification of the test report should be addressed to AGC by agc01@agccert.com.

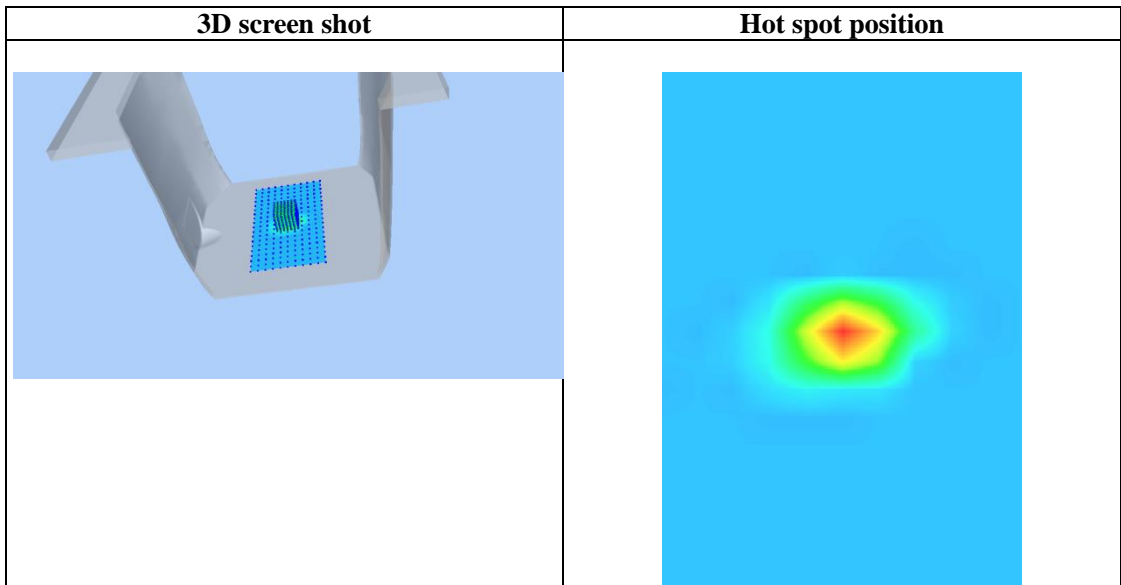
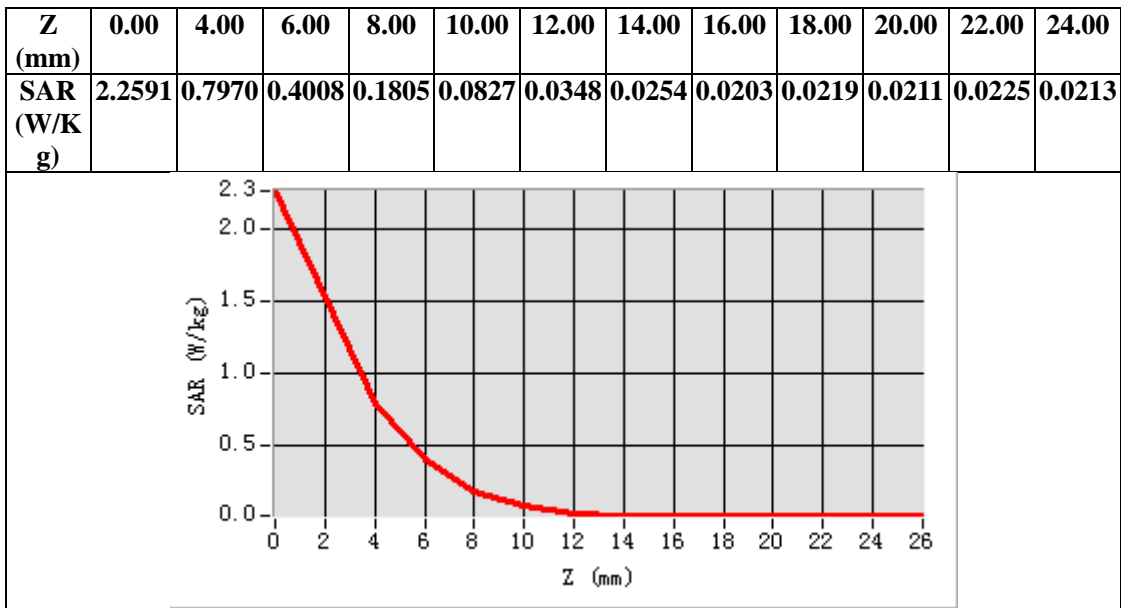

Any report having not been signed by authorized approver, or having been altered without authorization, or having not been stamped by the “Dedicated Testing/Inspection Stamp” is deemed to be invalid. Copying or excerpting portion of, or altering the content of the report is not permitted without the written authorization of AGC. The test results presented in the report apply only to the tested sample. Any objections to report issued by AGC should be submitted to AGC within 15days after the issuance of the test report. Further enquiry of validity or verification of the test report should be addressed to AGC by agc01@agccert.com.



**Test Laboratory: AGC Lab**  
**System Check Head 5300 MHz**  
**DUT: Dipole 5000MHz Type: SID5000**

**Date: Dec. 14, 2023**

Communication System: CW; Communication System Band: D5000 (5000.0 MHz); Duty Cycle: 1:1; Conv.F=1.35  
Frequency: 5300 MHz; Medium parameters used:  $f = 5300$  MHz;  $\sigma = 4.91$  mho/m;  $\epsilon_r = 36.59$ ;  $\rho = 1000$  kg/m<sup>3</sup> ;  
Phantom section: Flat Section; Input Power=10dBm  
Ambient temperature (°C): 21.3, Liquid temperature (°C): 21.0

**SATIMO Configuration:**

Probe: SSE2; Calibrated: May 31, 2023; Serial No.: 2023-EPGO-414  
Sensor-Surface: 4mm (Mechanical Surface Detection)  
Phantom: SAM twin phantom  
Measurement SW: OpenSAR V4\_02\_32

**Configuration/System Check 5300 MHz Head/Area Scan:** Measurement grid: dx=8mm, dy=8mm

**Configuration/System Check 5300 MHz Head/Zoom Scan:** Measurement grid: dx=4mm,dy=4mm, dz=2mm

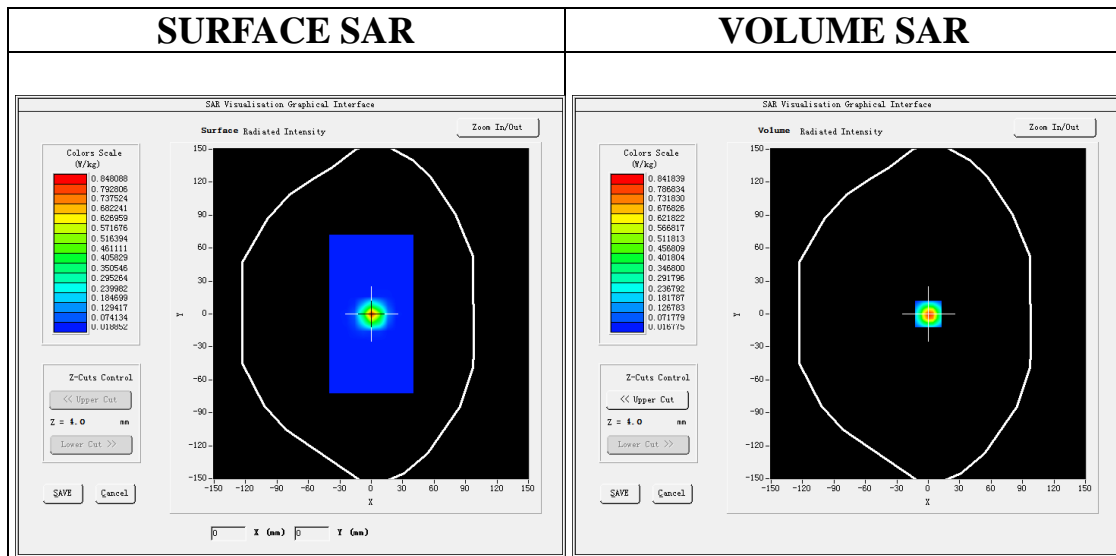

**Maximum location: X=0.00, Y=0.00**  
**SAR Peak: 2.34 W/kg**

<b>SAR 10g (W/Kg)</b>	0.224073
<b>SAR 1g (W/Kg)</b>	0.777915

Any report having not been signed by authorized approver, or having been altered without authorization, or having not been stamped by the “Dedicated Testing/Inspection Stamp” is deemed to be invalid. Copying or excerpting portion of, or altering the content of the report is not permitted without the written authorization of AGC. The test results presented in the report apply only to the tested sample. Any objections to report issued by AGC should be submitted to AGC within 15days after the issuance of the test report. Further enquiry of validity or verification of the test report should be addressed to AGC by agc01@agccert.com.

Z (mm)	0.00	4.00	6.00	8.00	10.00	12.00	14.00	16.00	18.00	20.00	22.00	24.00
SAR (W/Kg)	2.3698	0.8431	0.4246	0.1966	0.0885	0.0347	0.0259	0.0205	0.0238	0.0230	0.0224	0.0235

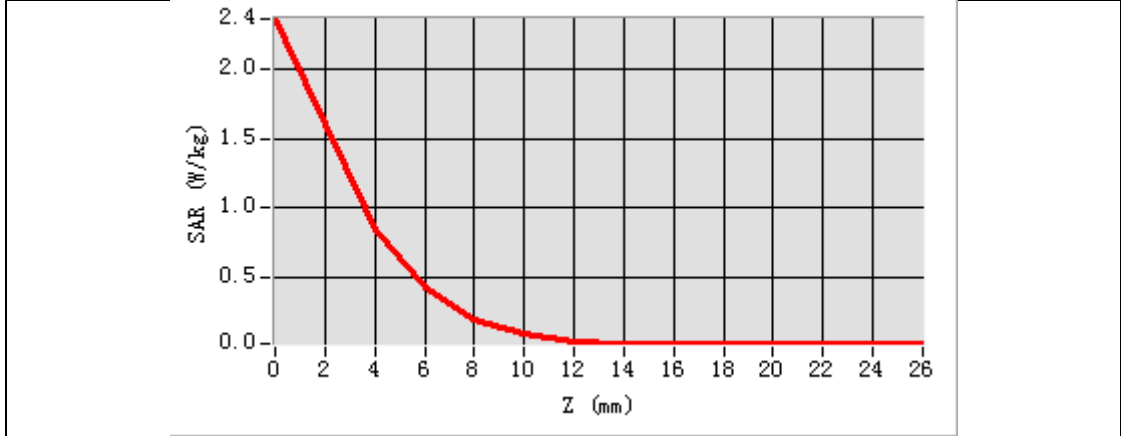

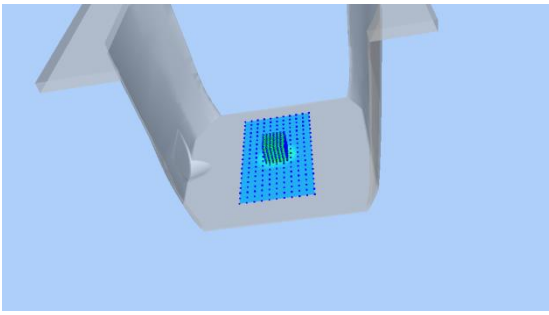
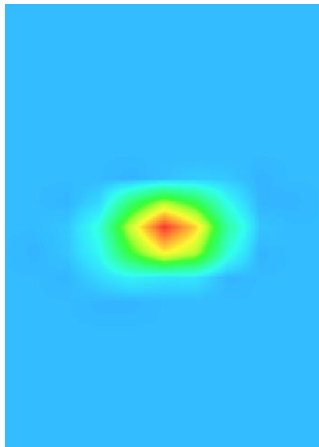
3D screen shot	Hot spot position
	

Any report having not been signed by authorized approver, or having been altered without authorization, or having not been stamped by the "Dedicated Testing/Inspection Stamp" is deemed to be invalid. Copying or excerpting portion of, or altering the content of the report is not permitted without the written authorization of AGC. The test results presented in the report apply only to the tested sample. Any objections to report issued by AGC should be submitted to AGC within 15days after the issuance of the test report. Further enquiry of validity or verification of the test report should be addressed to AGC by agc01@agccert.com.

**Test Laboratory: AGC Lab**  
**System Check Head 5600 MHz**  
**DUT: Dipole 5000MHz Type: SID5000**

**Date: Dec. 15, 2023**

Communication System: CW; Communication System Band: D5000 (5000.0 MHz); Duty Cycle: 1:1; Conv.F=1.53  
Frequency: 5600 MHz; Medium parameters used:  $f = 5600$  MHz;  $\sigma = 5.14$  mho/m;  $\epsilon_r = 36.55$ ;  $\rho = 1000$  kg/m<sup>3</sup> ;  
Phantom section: Flat Section; Input Power=10dBm  
Ambient temperature (°C): 21.4, Liquid temperature (°C): 21.0

**SATIMO Configuration:**

Probe: SSE2; Calibrated: May 31, 2023; Serial No.: 2023-EPGO-414  
Sensor-Surface: 4mm (Mechanical Surface Detection)  
Phantom: SAM twin phantom  
Measurement SW: OpenSAR V4\_02\_32

**Configuration/System Check 5600 MHz Head/Area Scan:** Measurement grid: dx=8mm, dy=8mm  
**Configuration/System Check 5600 MHz Head/Zoom Scan:** Measurement grid: dx=4mm,dy=4mm, dz=2mm

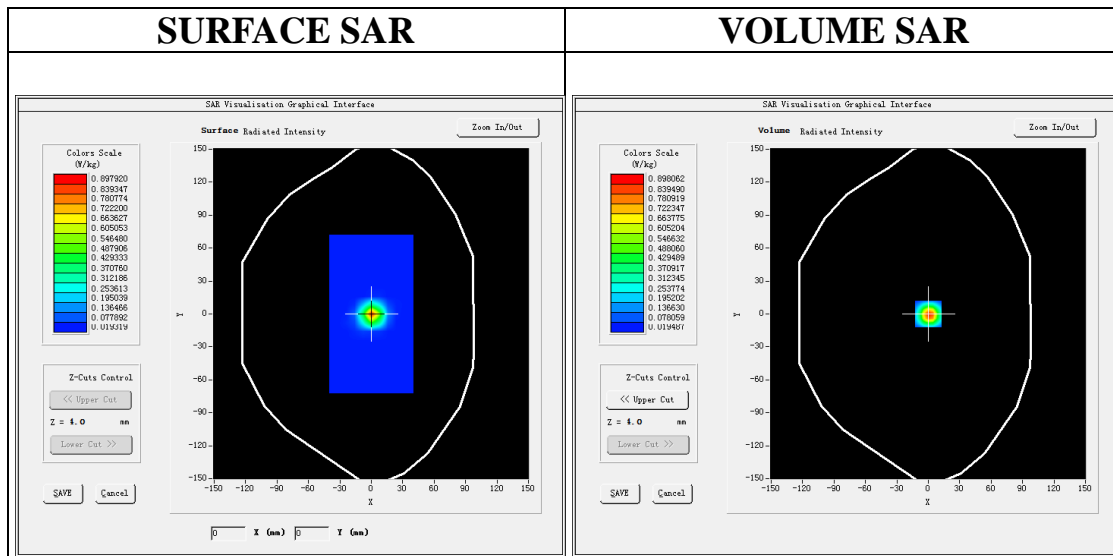

**Maximum location: X=0.00, Y=0.00**  
**SAR Peak: 2.49 W/kg**

<b>SAR 10g (W/Kg)</b>	0.232941
<b>SAR 1g (W/Kg)</b>	0.823269

Any report having not been signed by authorized approver, or having been altered without authorization, or having not been stamped by the "Dedicated Testing/Inspection Stamp" is deemed to be invalid. Copying or excerpting portion of, or altering the content of the report is not permitted without the written authorization of AGC. The test results presented in the report apply only to the tested sample. Any objections to report issued by AGC should be submitted to AGC within 15days after the issuance of the test report. Further enquiry of validity or verification of the test report should be addressed to AGC by agc01@agccert.com.

Z (mm)	0.00	4.00	6.00	8.00	10.00	12.00	14.00	16.00	18.00	20.00	22.00	24.00
SAR (W/Kg)	2.5124	0.8966	0.4501	0.2108	0.0934	0.0358	0.0240	0.0181	0.0205	0.0209	0.0202	0.0201

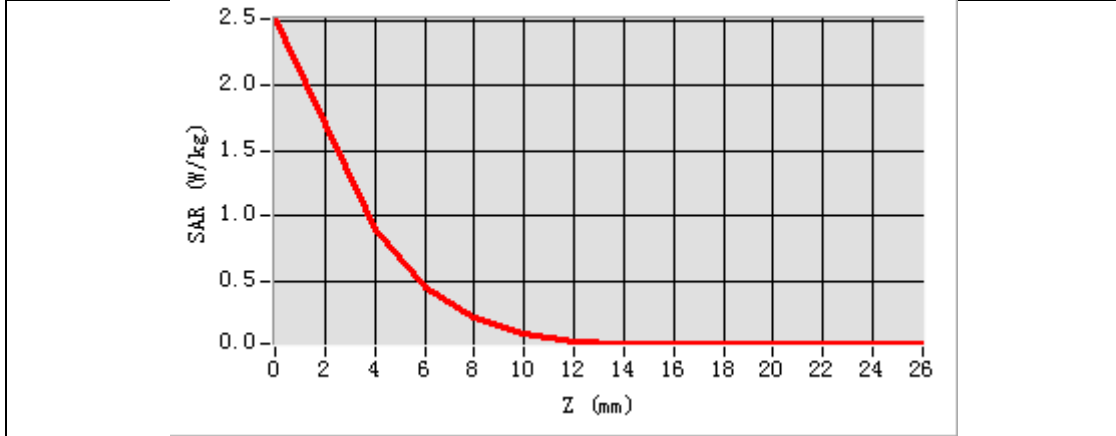

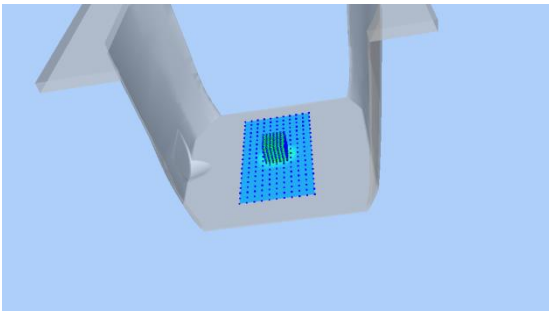
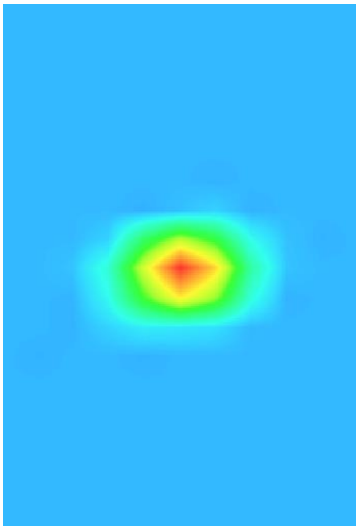
3D screen shot	Hot spot position
	

Any report having not been signed by authorized approver, or having been altered without authorization, or having not been stamped by the “Dedicated Testing/Inspection Stamp” is deemed to be invalid. Copying or excerpting portion of, or altering the content of the report is not permitted without the written authorization of AGC. The test results presented in the report apply only to the tested sample. Any objections to report issued by AGC should be submitted to AGC within 15days after the issuance of the test report. Further enquiry of validity or verification of the test report should be addressed to AGC by agc01@agccert.com.

**Test Laboratory: AGC Lab**  
**System Check Head 5800 MHz**

**Date: Dec. 16, 2023**

**DUT: Dipole 5000MHz Type: SID5500**

Communication System: CW; Communication System Band: D5000 (5000.0 MHz); Duty Cycle: 1:1; Conv.F=1.41  
Frequency: 5800 MHz; Medium parameters used:  $f = 5800$  MHz;  $\sigma = 5.25$  mho/m;  $\epsilon_r = 35.23$ ;  $\rho = 1000$  kg/m<sup>3</sup> ;  
Phantom section: Flat Section; Input Power=10dBm  
Ambient temperature (°C): 21.7, Liquid temperature (°C): 21.3

SATIMO Configuration:

- Probe: SSE2; Calibrated: May 31, 2023; Serial No.: 2023-EPGO-414
- Sensor-Surface: 4mm (Mechanical Surface Detection)
- Phantom: SAM twin phantom
- Measurement SW: OpenSAR V4\_02\_32

**Configuration/System Check 5800 MHz Head/Area Scan:** Measurement grid: dx=8mm, dy=8mm

**Configuration/System Check 5800 MHz Head/Zoom Scan:** Measurement grid: dx=4mm,dy=4mm, dz=2mm

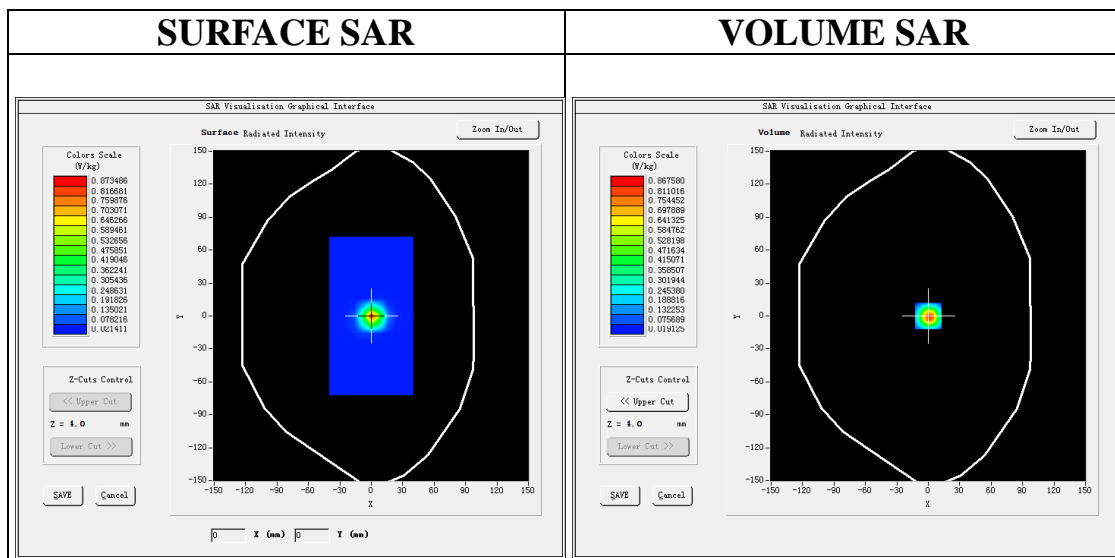

**Maximum location: X=0.00, Y=0.00**  
**SAR Peak: 2.45 W/kg**

<b>SAR 10g (W/Kg)</b>	0.232296
<b>SAR 1g (W/Kg)</b>	0.806501

Any report having not been signed by authorized approver, or having been altered without authorization, or having not been stamped by the "Dedicated Testing/Inspection Stamp" is deemed to be invalid. Copying or excerpting portion of, or altering the content of the report is not permitted without the written authorization of AGC. The test results presented in the report apply only to the tested sample. Any objections to report issued by AGC should be submitted to AGC within 15days after the issuance of the test report. Further enquiry of validity or verification of the test report should be addressed to AGC by agc01@agccert.com.

Z (mm)	0.00	4.00	6.00	8.00	10.00	12.00	14.00	16.00	18.00	20.00	22.00	24.00
SAR (W/Kg)	2.4596	0.8688	0.4335	0.1986	0.0927	0.0370	0.0283	0.0229	0.0251	0.0255	0.0248	0.0250

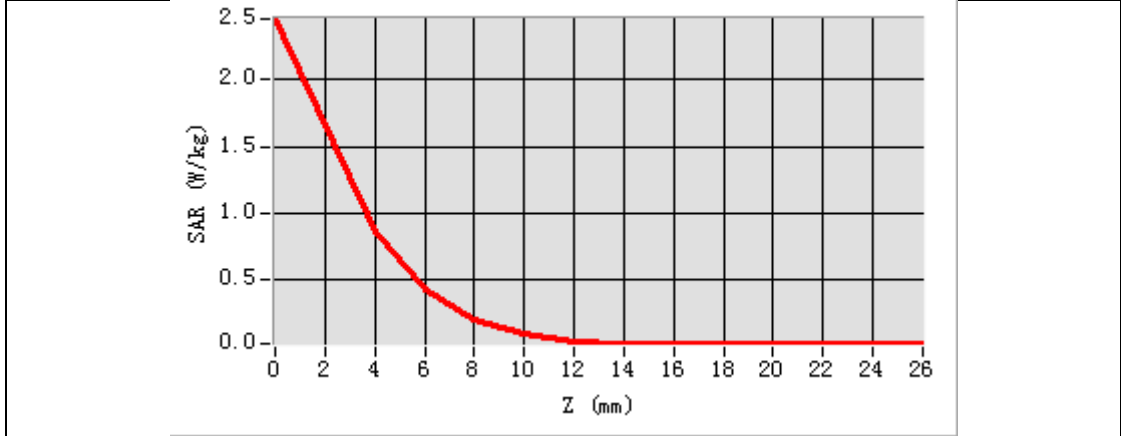

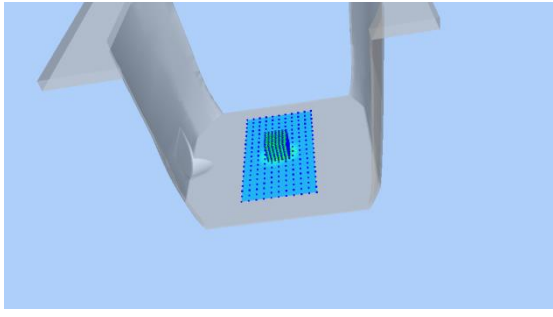
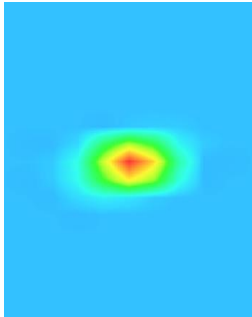
3D screen shot	Hot spot position
	

Any report having not been signed by authorized approver, or having been altered without authorization, or having not been stamped by the “Dedicated Testing/Inspection Stamp” is deemed to be invalid. Copying or excerpting portion of, or altering the content of the report is not permitted without the written authorization of AGC. The test results presented in the report apply only to the tested sample. Any objections to report issued by AGC should be submitted to AGC within 15days after the issuance of the test report. Further enquiry of validity or verification of the test report should be addressed to AGC by agc01@agccert.com.

## APPENDIX B. SAR MEASUREMENT DATA

Test Laboratory: AGC Lab  
WCDMA Band II Low-Edge 3(Bottom)(RMC)  
DUT: Body Worn Camera ; Type: K7

Date: Dec. 01, 2023

Communication System: UMTS; Communication System Band: Band II UTRA/FDD ;Duty Cycle:1:1; Conv.F=2.15  
Frequency: 1852.4 MHz; Medium parameters used:  $f = 1900$  MHz;  $\sigma = 1.35$  mho/m;  $\epsilon_r = 42.03$ ;  $\rho = 1000$  kg/m<sup>3</sup> ;  
Phantom section: Flat Section  
Ambient temperature (°C): 20.7, Liquid temperature (°C): 20.3

### SATIMO Configuration:

Probe: SSE2; Calibrated: May 31, 2023; Serial No.: 2023-EPGO-414  
Sensor-Surface: 4mm (Mechanical Surface Detection)  
Phantom: SAM twin phantom  
Measurement SW: OpenSAR V4\_02\_32

Configuration/ WCDMA band II Low-Edge 3(Bottom)/Area Scan: Measurement grid: dx=8mm, dy=8mm  
Configuration/ WCDMA band II Low-Edge 3(Bottom)/Zoom Scan: Measurement grid: dx=8mm, dy=8mm, dz=5mm;

Area Scan	surf_sam_plan.txt, h= 5.00 mm
Zoom Scan	5x5x7,dx=8mm dy=8mm dz=5mm,Complete
Phantom	Validation plane
Device Position	Edge 3(Bottom)
Band	WCDMA band II
Channels	Low
Signal	CDMA (Crest factor: 1.0)

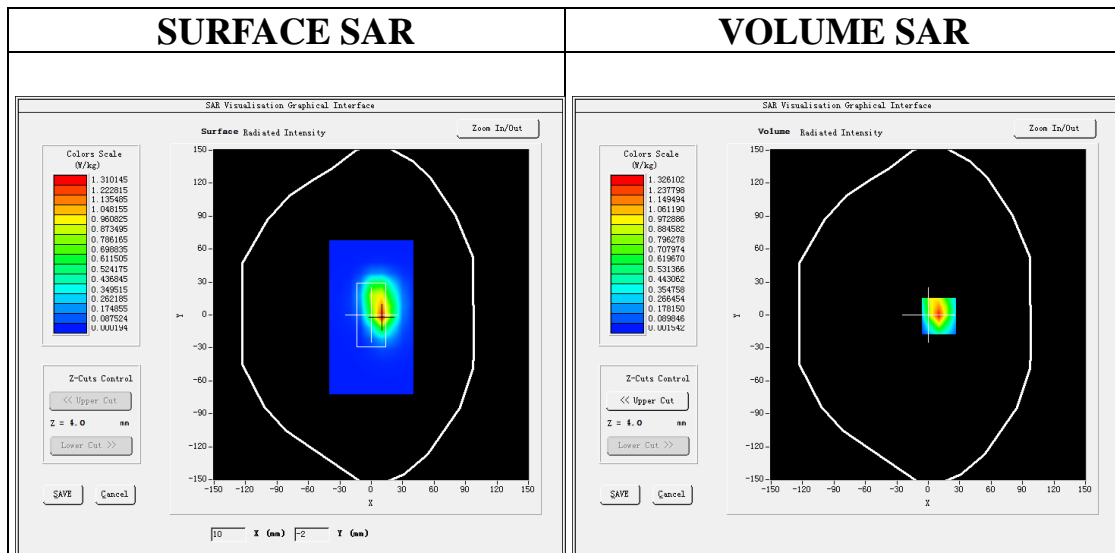

**Maximum location: X=10.00, Y=-1.00**  
**SAR Peak: 2.56 W/kg**

SAR 10g (W/Kg)	0.497991
SAR 1g (W/Kg)	1.229424

Any report having not been signed by authorized approver, or having been altered without authorization, or having not been stamped by the "Dedicated Testing/Inspection Stamp" is deemed to be invalid. Copying or excerpting portion of, or altering the content of the report is not permitted without the written authorization of AGC. The test results presented in the report apply only to the tested sample. Any objections to report issued by AGC should be submitted to AGC within 15days after the issuance of the test report. Further enquiry of validity or verification of the test report should be addressed to AGC by agc01@agccert.com.

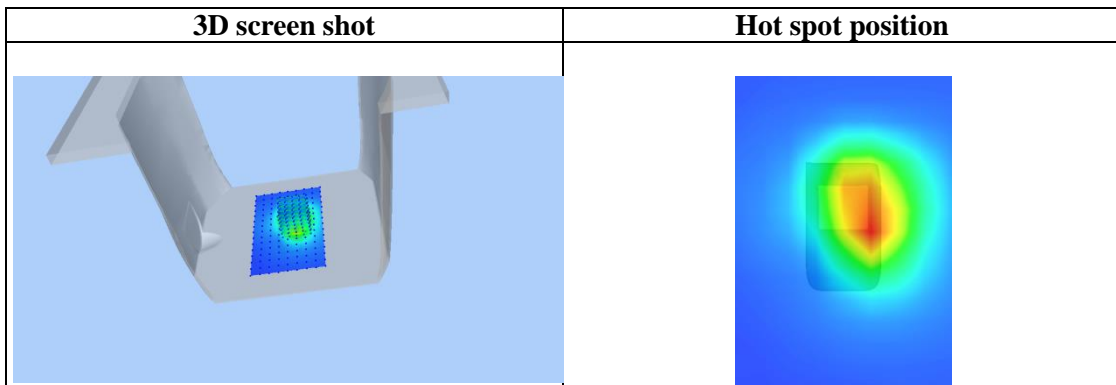
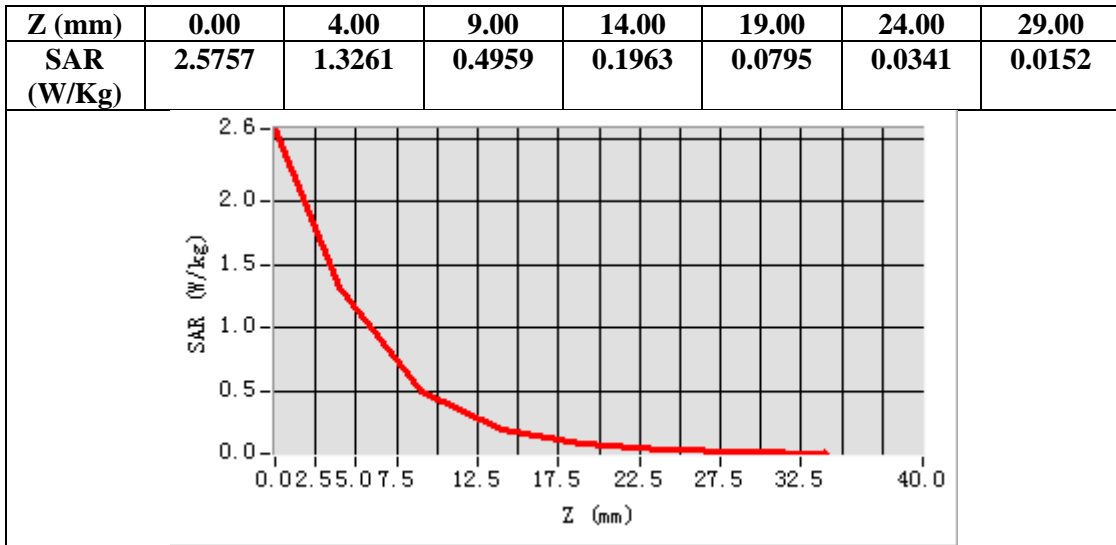

Any report having not been signed by authorized approver, or having been altered without authorization, or having not been stamped by the “Dedicated Testing/Inspection Stamp” is deemed to be invalid. Copying or excerpting portion of, or altering the content of the report is not permitted without the written authorization of AGC. The test results presented in the report apply only to the tested sample. Any objections to report issued by AGC should be submitted to AGC within 15days after the issuance of the test report. Further enquiry of validity or verification of the test report should be addressed to AGC by agc01@agccert.com.



**Test Laboratory: AGC Lab**  
**WCDMA Band II Mid-Edge 3(Bottom)(RMC)**  
**DUT: Body Worn Camera ; Type: K7**

**Date: Dec. 01, 2023**

Communication System: UMTS; Communication System Band: Band II UTRA/FDD ;Duty Cycle:1:1; Conv.F=2.15  
Frequency: 1880 MHz; Medium parameters used:  $f = 1900$  MHz;  $\sigma=1.40$  mho/m;  $\epsilon_r=40.36$ ;  $\rho= 1000$  kg/m<sup>3</sup> ;  
Phantom section: Flat Section  
Ambient temperature (°C): 20.7, Liquid temperature (°C): 20.3

**SATIMO Configuration:**

Probe: SSE2; Calibrated: May 31, 2023; Serial No.: 2023-EPGO-414  
Sensor-Surface: 4mm (Mechanical Surface Detection)  
Phantom: SAM twin phantom  
Measurement SW: OpenSAR V4\_02\_32

**Configuration/ WCDMA band II Mid-Edge 3(Bottom)/Area Scan:** Measurement grid: dx=8mm, dy=8mm  
**Configuration/ WCDMA band II Mid-Edge 3(Bottom)/Zoom Scan:** Measurement grid: dx=8mm,dy=8mm, dz=5mm;

<b>Area Scan</b>	surf_sam_plan.txt, h= 5.00 mm
<b>Zoom Scan</b>	5x5x7,dx=8mm dy=8mm dz=5mm,Complete
<b>Phantom</b>	Validation plane
<b>Device Position</b>	Edge 3(Bottom)
<b>Band</b>	WCDMA band II
<b>Channels</b>	Middle
<b>Signal</b>	CDMA (Crest factor: 1.0)

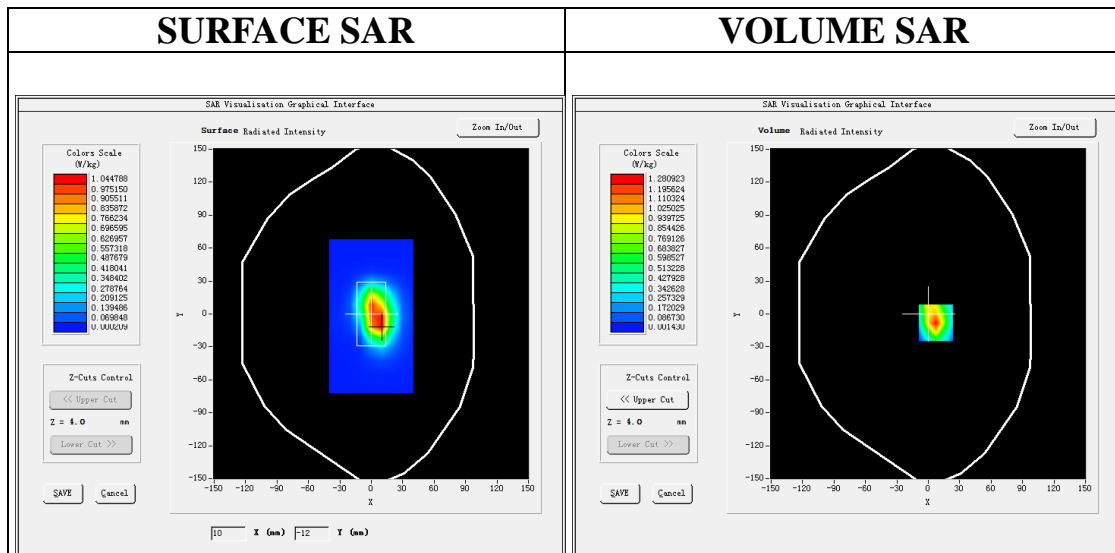

**Maximum location: X=7.00, Y=-8.00**

**SAR Peak: 2.45 W/kg**

<b>SAR 10g (W/Kg)</b>	0.489695
<b>SAR 1g (W/Kg)</b>	1.192077

Any report having not been signed by authorized approver, or having been altered without authorization, or having not been stamped by the “Dedicated Testing/Inspection Stamp” is deemed to be invalid. Copying or excerpting portion of, or altering the content of the report is not permitted without the written authorization of AGC. The test results presented in the report apply only to the tested sample. Any objections to report issued by AGC should be submitted to AGC within 15days after the issuance of the test report. Further enquiry of validity or verification of the test report should be addressed to AGC by agc01@agccert.com.

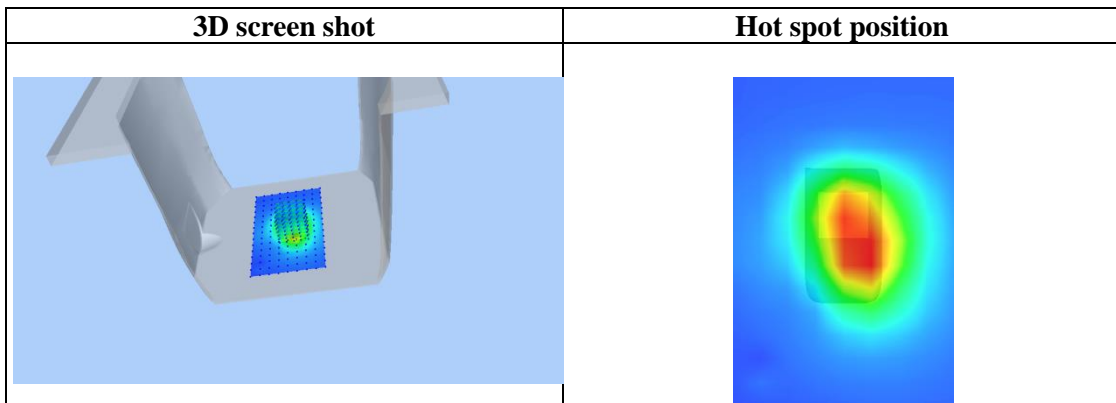
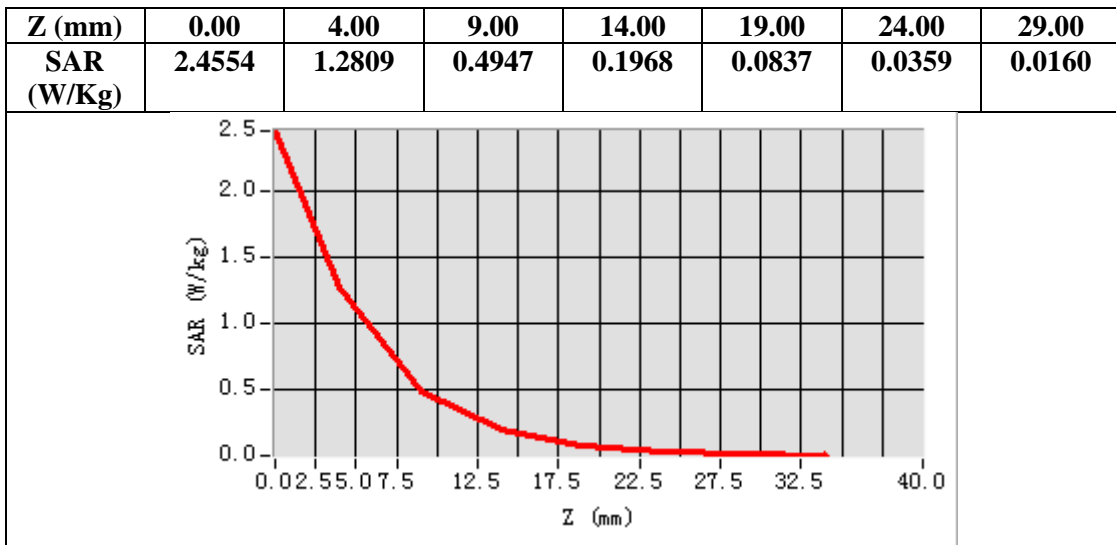

Any report having not been signed by authorized approver, or having been altered without authorization, or having not been stamped by the “Dedicated Testing/Inspection Stamp” is deemed to be invalid. Copying or excerpting portion of, or altering the content of the report is not permitted without the written authorization of AGC. The test results presented in the report apply only to the tested sample. Any objections to report issued by AGC should be submitted to AGC within 15days after the issuance of the test report. Further enquiry of validity or verification of the test report should be addressed to AGC by agc01@agccert.com.

**Test Laboratory: AGC Lab**  
**WCDMA Band IV High- Edge 3(Bottom) (RMC)**  
**DUT: Body Worn Camera ; Type: K7**

**Date: Dec. 20, 2023**

Communication System: UMTS; Communication System Band: BAND IV UTRA/FDD; Duty Cycle:1: 1; Conv.F=2.17;  
Frequency:1752.6 MHz; Medium parameters used:  $f = 1750$  MHz;  $\sigma = 1.42$  mho/m;  $\epsilon_r = 38.92$ ;  $\rho = 1000$  kg/m<sup>3</sup>;  
Phantom section: Flat Section  
Ambient temperature (°C): 21.7, Liquid temperature (°C): 21.2

**SATIMO Configuration:**

Probe: SSE2; Calibrated: May 31, 2023; Serial No.: 2023-EPGO-414  
Sensor-Surface: 4mm (Mechanical Surface Detection)  
Phantom: SAM twin phantom  
Measurement SW: OpenSAR V4\_02\_32

**Configuration/ WCDMA Band IV High- Edge 3(Bottom)/Area Scan:** Measurement grid: dx=8mm, dy=8mm  
**Configuration/ WCDMA Band IV High- Edge 3(Bottom)/Zoom Scan:** Measurement grid: dx=8mm,dy=8mm, dz=5mm;

<b>Area Scan</b>	surf_sam_plan.txt, h= 5.00 mm
<b>ZoomScan</b>	5x5x7,dx=8mm dy=8mm dz=5mm,Complete
<b>Phantom</b>	Validation plane
<b>Device Position</b>	Edge 3(Bottom)
<b>Band</b>	WCDMA Band IV
<b>Channels</b>	High
<b>Signal</b>	CDMA (Crest factor: 1.0)

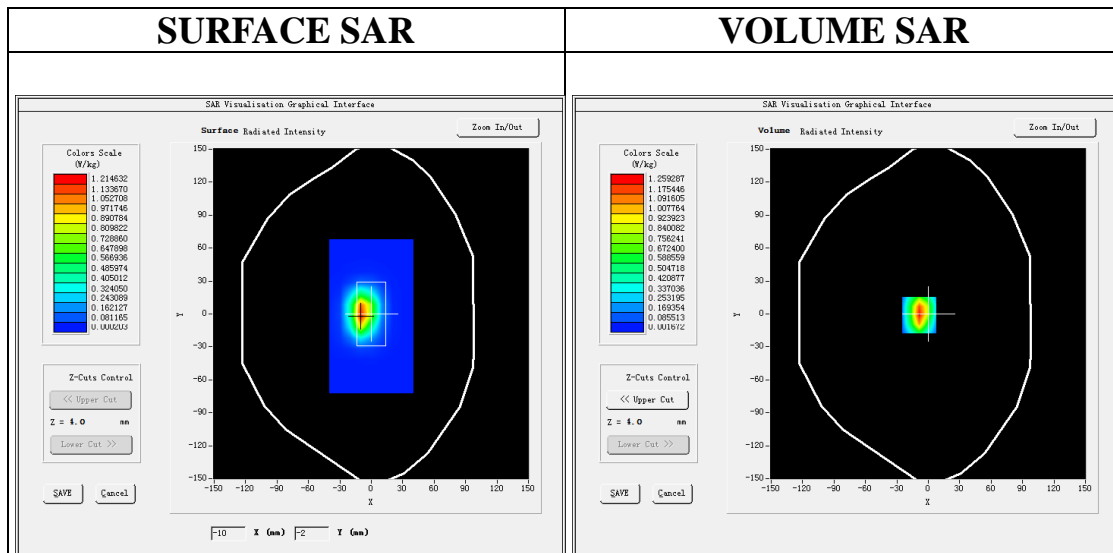

**Maximum location: X=-9.00, Y=-1.00**

**SAR Peak: 2.11 W/kg**

<b>SAR 10g (W/Kg)</b>	0.524886
<b>SAR 1g (W/Kg)</b>	1.154921

Any report having not been signed by authorized approver, or having been altered without authorization, or having not been stamped by the "Dedicated Testing/Inspection Stamp" is deemed to be invalid. Copying or excerpting portion of, or altering the content of the report is not permitted without the written authorization of AGC. The test results presented in the report apply only to the tested sample. Any objections to report issued by AGC should be submitted to AGC within 15days after the issuance of the test report. Further enquiry of validity or verification of the test report should be addressed to AGC by agc01@agccert.com.

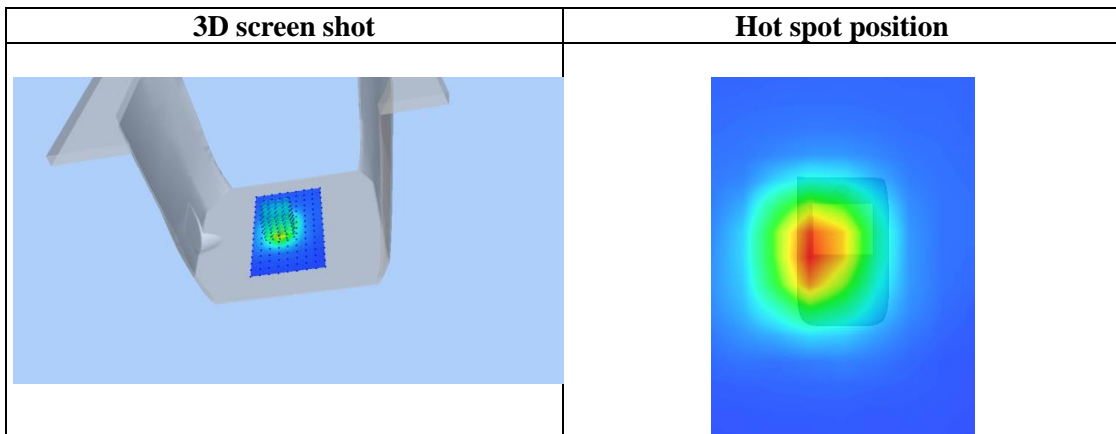
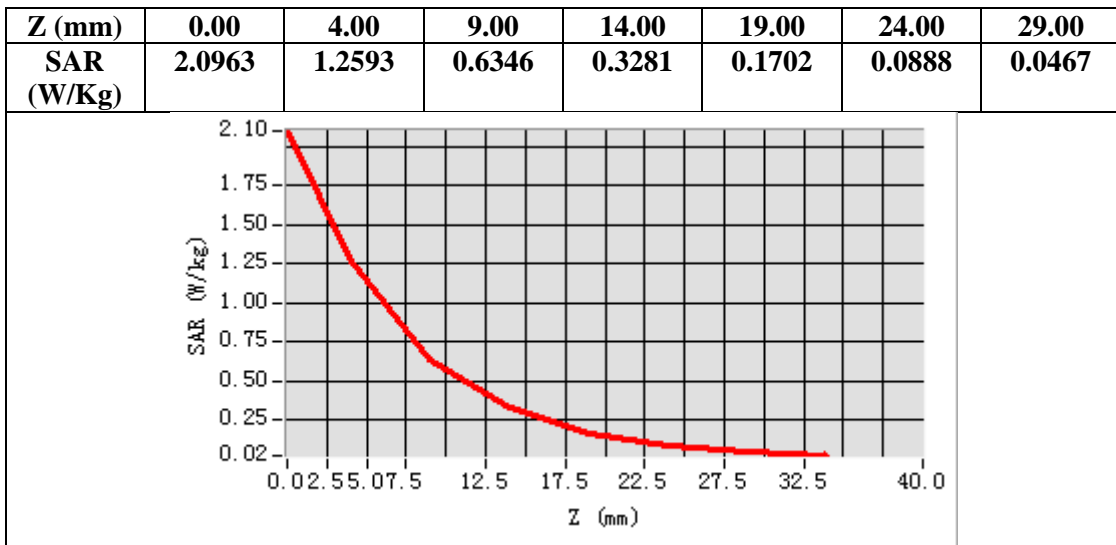

Any report having not been signed by authorized approver, or having been altered without authorization, or having not been stamped by the "Dedicated Testing/Inspection Stamp" is deemed to be invalid. Copying or excerpting portion of, or altering the content of the report is not permitted without the written authorization of AGC. The test results presented in the report apply only to the tested sample. Any objections to report issued by AGC should be submitted to AGC within 15days after the issuance of the test report. Further enquiry of validity or verification of the test report should be addressed to AGC by agc01@agccert.com.

Test Laboratory: AGC Lab

Date: Dec. 05, 2023

WCDMA Band V High- Edge 3(Bottom) (RMC)

DUT: Body Worn Camera ; Type: K7

Communication System: UMTS; Communication System Band: BAND V UTRA/FDD; Duty Cycle:1: 1; Conv.F=2.02; Frequency: 846.6 MHz; Medium parameters used:  $f = 835\text{MHz}$ ;  $\sigma = 0.94 \text{ mho/m}$ ;  $\epsilon_r = 39.67$ ;  $\rho = 1000 \text{ kg/m}^3$  ; Phantom section: Flat Section  
Ambient temperature ( $^{\circ}\text{C}$ ): 22.4, Liquid temperature ( $^{\circ}\text{C}$ ): 21.7

SATIMO Configuration:

Probe: SSE2; Calibrated: May 31, 2023; Serial No.: 2023-EPGO-414

Sensor-Surface: 4mm (Mechanical Surface Detection)

Phantom: SAM twin phantom

Measurement SW: OpenSAR V4\_02\_32

**Configuration/ WCDMA Band V High- Edge 3(Bottom)/Area Scan:** Measurement grid: dx=8mm, dy=8mm  
**Configuration/ WCDMA Band V High- Edge 3(Bottom)/Zoom Scan:** Measurement grid: dx=8mm,dy=8mm, dz=5mm;

<b>Area Scan</b>	surf_sam_plan.txt, h= 5.00 mm
<b>ZoomScan</b>	5x5x7,dx=8mm dy=8mm dz=5mm,Complete
<b>Phantom</b>	Validation plane
<b>Device Position</b>	Edge 3(Bottom)
<b>Band</b>	WCDMA Band V
<b>Channels</b>	High
<b>Signal</b>	CDMA (Crest factor: 1.0)

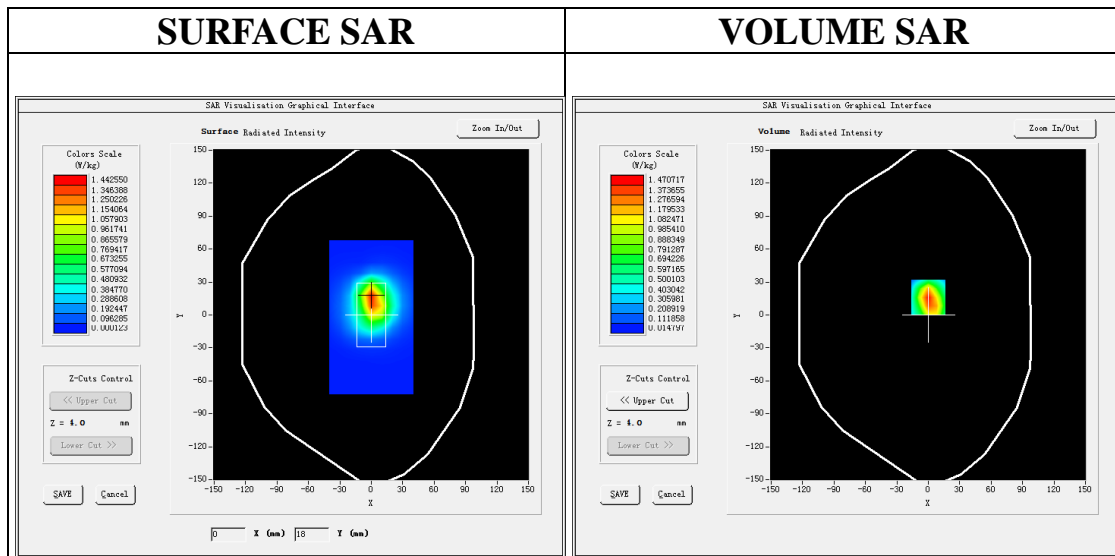

**Maximum location: X=0.00, Y=16.00**

**SAR Peak: 2.56 W/kg**

<b>SAR 10g (W/Kg)</b>	0.675381
<b>SAR 1g (W/Kg)</b>	1.384736

Any report having not been signed by authorized approver, or having been altered without authorization, or having not been stamped by the "Dedicated Testing/Inspection Stamp" is deemed to be invalid. Copying or excerpting portion of, or altering the content of the report is not permitted without the written authorization of AGC. The test results presented in the report apply only to the tested sample. Any objections to report issued by AGC should be submitted to AGC within 15days after the issuance of the test report. Further enquiry of validity or verification of the test report should be addressed to AGC by agc01@agccert.com.

Attestation of Global Compliance(Shenzhen)Co., Ltd

Attestation of Global Compliance(Shenzhen)Std & Tech Co., Ltd

Tel: +86-755 2523 4088 E-mail: agc@agccert.com Web: http://www.agccert.com/

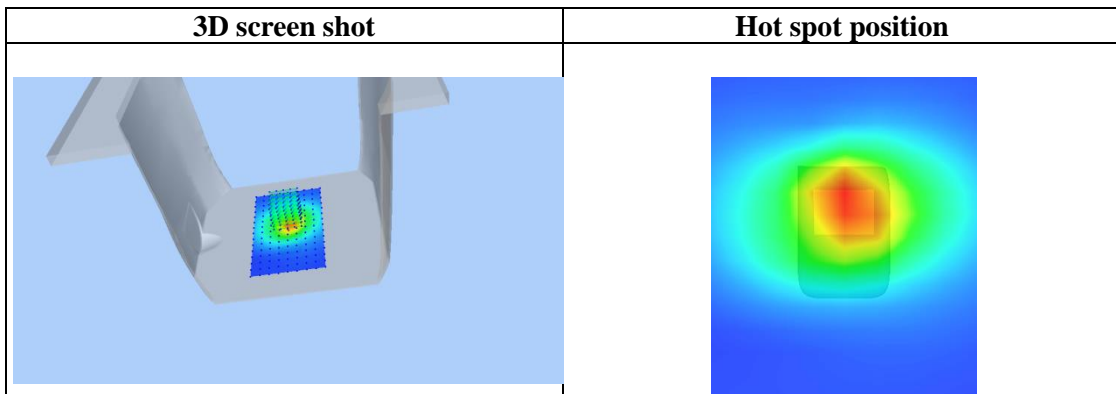
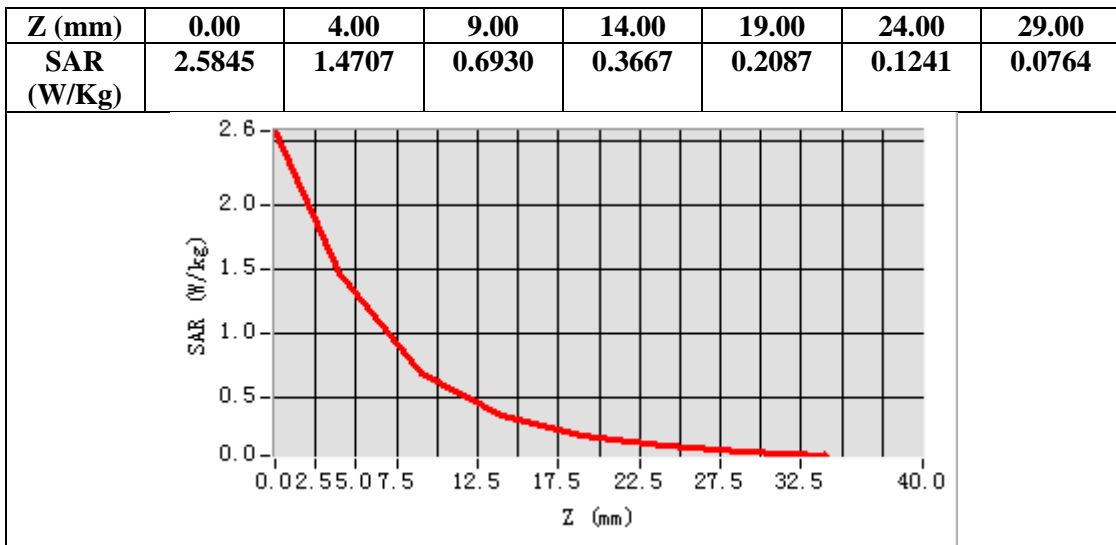

Any report having not been signed by authorized approver, or having been altered without authorization, or having not been stamped by the “Dedicated Testing/Inspection Stamp” is deemed to be invalid. Copying or excerpting portion of, or altering the content of the report is not permitted without the written authorization of AGC. The test results presented in the report apply only to the tested sample. Any objections to report issued by AGC should be submitted to AGC within 15days after the issuance of the test report. Further enquiry of validity or verification of the test report should be addressed to AGC by agc01@agccert.com.

**Test Laboratory: AGC Lab**  
**LTE Band 2 Mid-Edge 3(Bottom) (1 RB#0)**  
**DUT: Body Worn Camera ; Type: K7**

**Date: Dec. 01, 2023**

Communication System: LTE; Communication System Band: LTE Band 2; Duty Cycle:1:1; Conv.F=2.15;  
Frequency:1880MHz; Medium parameters used:  $f = 1900$  MHz;  $\sigma = 1.40$  mho/m;  $\epsilon_r = 40.36$ ;  $\rho = 1000$  kg/m<sup>3</sup> ;  
Phantom section: Flat Section  
Ambient temperature (°C): 20.7, Liquid temperature (°C): 20.3

**SATIMO Configuration:**

Probe: SSE2; Calibrated: May 31, 2023; Serial No.: 2023-EPGO-414  
Sensor-Surface: 4mm (Mechanical Surface Detection)  
Phantom: SAM twin phantom  
Measurement SW: OpenSAR V4\_02\_32

**Configuration/ LTE Band 2 Mid-Edge 3(Bottom)/Area Scan:** Measurement grid: dx=8mm, dy=8mm  
**Configuration/ LTE Band 2 Mid-Edge 3(Bottom)/Zoom Scan:** Measurement grid: dx=8mm,dy=8mm, dz=5mm;

<b>Area Scan</b>	surf_sam_plan.txt, h= 5.00 mm
<b>Zoom Scan</b>	5x5x7,dx=8mm dy=8mm dz=5mm
<b>Phantom</b>	Validation plane
<b>Device Position</b>	Edge 3(Bottom)
<b>Band</b>	LTE Band 2
<b>Channels</b>	Middle
<b>Signal</b>	OFDM (Crest factor: 1.0)

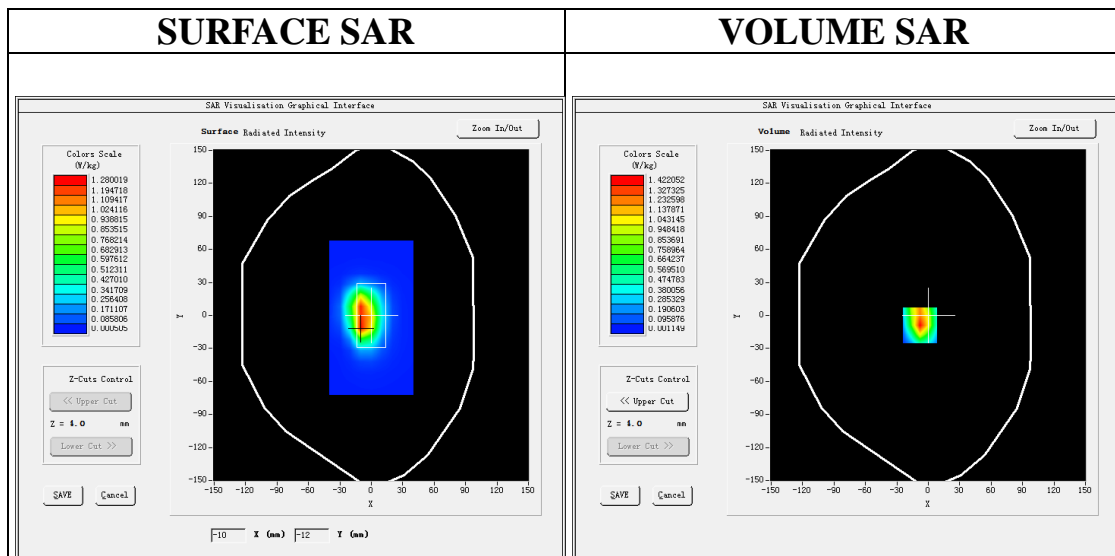

**Maximum location: X=-8.00, Y=-9.00**  
**SAR Peak: 2.76 W/kg**

<b>SAR 10g (W/Kg)</b>	0.555288
<b>SAR 1g (W/Kg)</b>	1.332950

Any report having not been signed by authorized approver, or having been altered without authorization, or having not been stamped by the “Dedicated Testing/Inspection Stamp” is deemed to be invalid. Copying or excerpting portion of, or altering the content of the report is not permitted without the written authorization of AGC. The test results presented in the report apply only to the tested sample. Any objections to report issued by AGC should be submitted to AGC within 15days after the issuance of the test report. Further enquiry of validity or verification of the test report should be addressed to AGC by agc01@agccert.com.

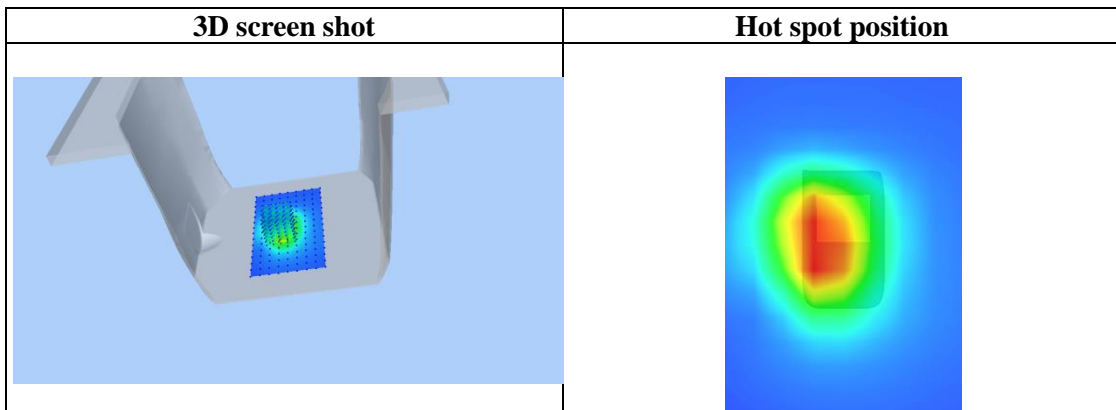
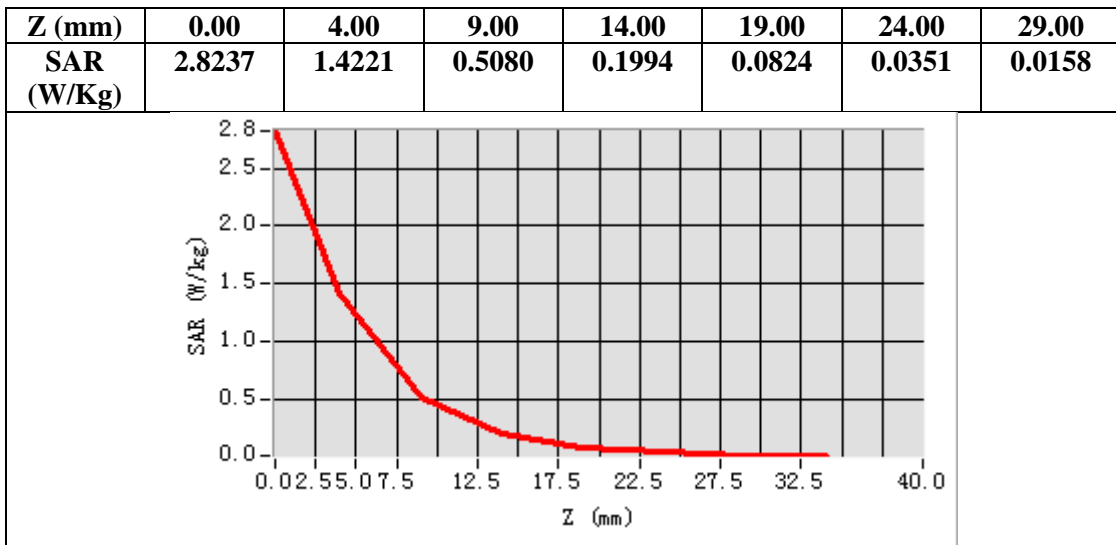

Any report having not been signed by authorized approver, or having been altered without authorization, or having not been stamped by the "Dedicated Testing/Inspection Stamp" is deemed to be invalid. Copying or excerpting portion of, or altering the content of the report is not permitted without the written authorization of AGC. The test results presented in the report apply only to the tested sample. Any objections to report issued by AGC should be submitted to AGC within 15days after the issuance of the test report. Further enquiry of validity or verification of the test report should be addressed to AGC by agc01@agccert.com.



**Test Laboratory: AGC Lab**  
**LTE Band 4 Mid-Edge 3(Bottom) (1 RB#0)**  
**DUT: Body Worn Camera ; Type: K7**

**Date: Dec. 20, 2023**

Communication System: LTE; Communication System Band: LTE Band 4; Duty Cycle:1:1; Conv.F=2.17;  
Frequency:1732.5 MHz; Medium parameters used:  $f = 1750$  MHz;  $\sigma = 1.36$  mho/m;  $\epsilon_r = 40.92$ ;  $\rho = 1000$  kg/m<sup>3</sup> ;  
Phantom section: Flat Section  
Ambient temperature (°C): 21.7, Liquid temperature (°C): 21.2

**SATIMO Configuration:**

Probe: SSE2; Calibrated: May 31, 2023; Serial No.: 2023-EPGO-414  
Sensor-Surface: 4mm (Mechanical Surface Detection)  
Phantom: SAM twin phantom  
Measurement SW: OpenSAR V4\_02\_32

**Configuration/ LTE Band 4 Mid-Edge 3(Bottom)/Area Scan:** Measurement grid: dx=8mm, dy=8mm  
**Configuration/ LTE Band 4 Mid-Edge 3(Bottom)/Zoom Scan:** Measurement grid: dx=8mm,dy=8mm, dz=5mm;

<b>Area Scan</b>	surf_sam_plan.txt, h= 5.00 mm
<b>Zoom Scan</b>	5x5x7,dx=8mm dy=8mm dz=5mm
<b>Phantom</b>	Validation plane
<b>Device Position</b>	Edge 3(Bottom)
<b>Band</b>	LTE Band 4
<b>Channels</b>	Middle
<b>Signal</b>	OFDM (Crest factor: 1.0)

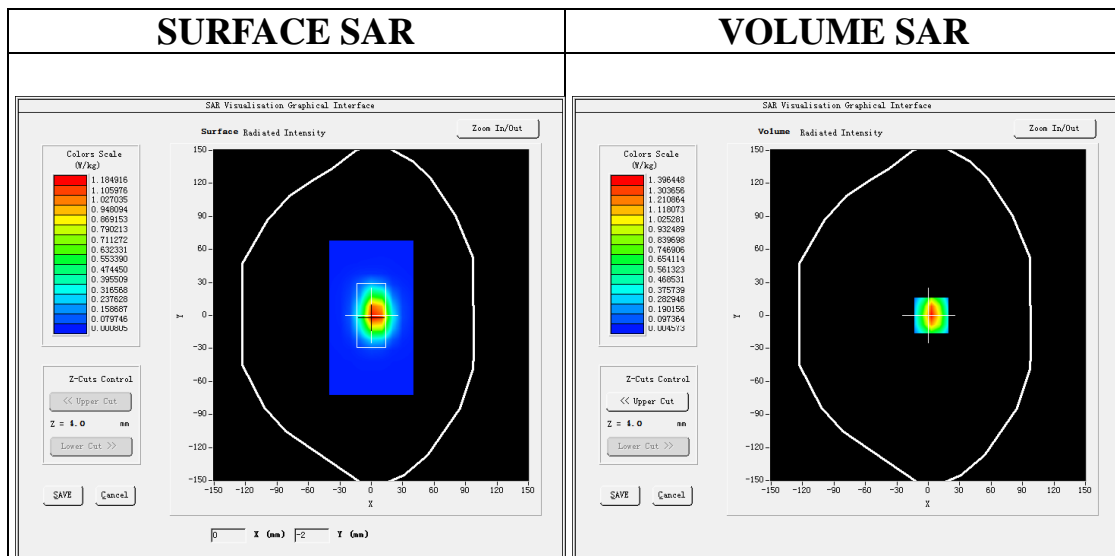

**Maximum location: X=3.00, Y=0.00**

**SAR Peak: 2.36 W/kg**

<b>SAR 10g (W/Kg)</b>	0.599312
<b>SAR 1g (W/Kg)</b>	1.288149

Any report having not been signed by authorized approver, or having been altered without authorization, or having not been stamped by the “Dedicated Testing/Inspection Stamp” is deemed to be invalid. Copying or excerpting portion of, or altering the content of the report is not permitted without the written authorization of AGC. The test results presented in the report apply only to the tested sample. Any objections to report issued by AGC should be submitted to AGC within 15days after the issuance of the test report. Further enquiry of validity or verification of the test report should be addressed to AGC by agc01@agccert.com.

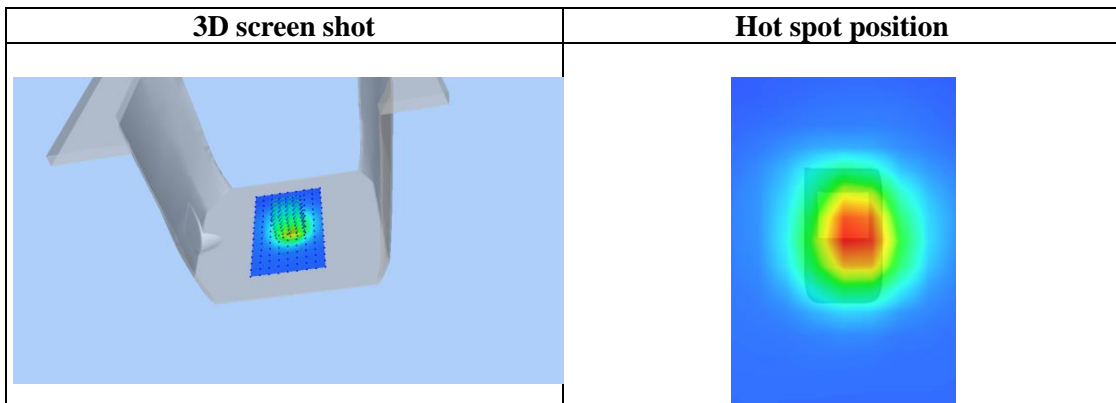
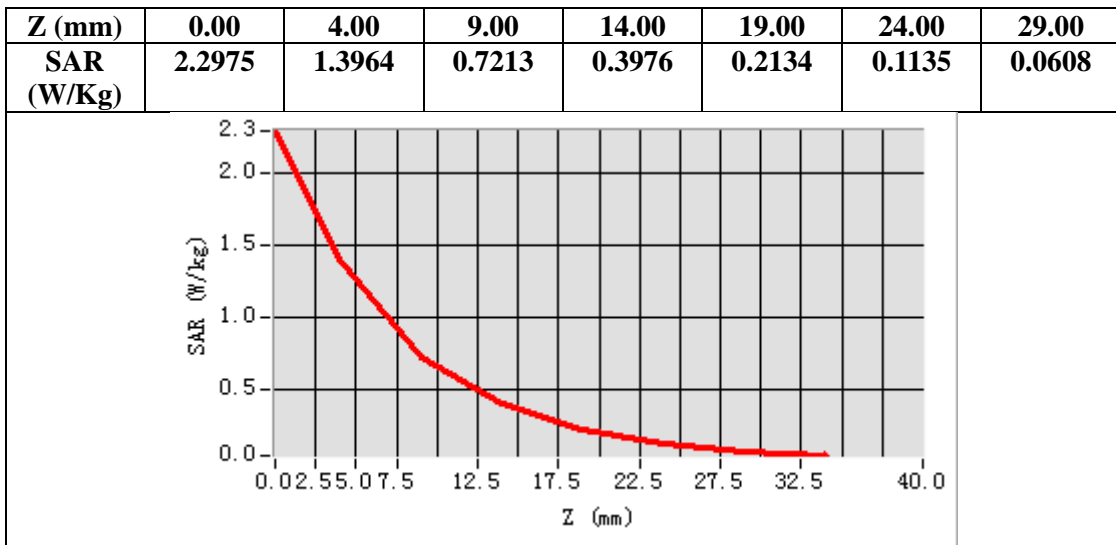

Any report having not been signed by authorized approver, or having been altered without authorization, or having not been stamped by the “Dedicated Testing/Inspection Stamp” is deemed to be invalid. Copying or excerpting portion of, or altering the content of the report is not permitted without the written authorization of AGC. The test results presented in the report apply only to the tested sample. Any objections to report issued by AGC should be submitted to AGC within 15days after the issuance of the test report. Further enquiry of validity or verification of the test report should be addressed to AGC by agc01@agccert.com.

**Test Laboratory: AGC Lab**  
**LTE Band 5 Low-Edge 3(Bottom) (1 RB#0)**  
**DUT: Body Worn Camera ; Type: K7**

**Date: Dec. 05, 2023**

Communication System: LTE; Communication System Band: LTE Band 5; Duty Cycle:1:1; Conv.F=2.02  
Frequency:829 MHz; Medium parameters used:  $f = 835$  MHz;  $\sigma = 0.89$  mho/m;  $\epsilon_r = 42.35$ ;  $\rho = 1000$  kg/m<sup>3</sup> ;  
Phantom section: Flat Section  
Ambient temperature (°C): 22.4, Liquid temperature (°C): 21.7

**SATIMO Configuration:**

Probe: SSE2; Calibrated: May 31, 2023; Serial No.: 2023-EPGO-414  
Sensor-Surface: 4mm (Mechanical Surface Detection)  
Phantom: SAM twin phantom  
Measurement SW: OpenSAR V4\_02\_32

**Configuration/ LTE Band 5 Low-Edge 3(Bottom)/Area Scan:** Measurement grid: dx=8mm, dy=8mm  
**Configuration/ LTE Band 5 Low-Edge 3(Bottom)/Zoom Scan:** Measurement grid: dx=8mm,dy=8mm, dz=5mm;

<b>Area Scan</b>	surf_sam_plan.txt, h= 5.00 mm
<b>Zoom Scan</b>	5x5x7,dx=8mm dy=8mm dz=5mm
<b>Phantom</b>	Validation plane
<b>Device Position</b>	Edge 3(Bottom)
<b>Band</b>	LTE Band 5
<b>Channels</b>	Low
<b>Signal</b>	OFDM (Crest factor: 1.0)

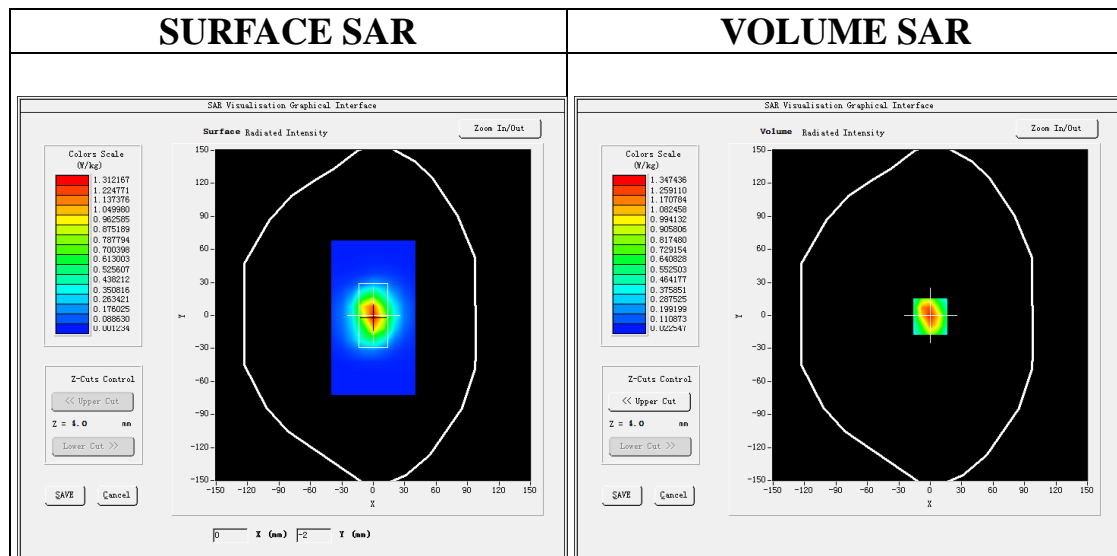

**Maximum location: X=0.00, Y=-1.00**  
**SAR Peak: 2.34 W/kg**

<b>SAR 10g (W/Kg)</b>	0.640174
<b>SAR 1g (W/Kg)</b>	1.287849

Any report having not been signed by authorized approver, or having been altered without authorization, or having not been stamped by the “Dedicated Testing/Inspection Stamp” is deemed to be invalid. Copying or excerpting portion of, or altering the content of the report is not permitted without the written authorization of AGC. The test results presented in the report apply only to the tested sample. Any objections to report issued by AGC should be submitted to AGC within 15days after the issuance of the test report. Further enquiry of validity or verification of the test report should be addressed to AGC by agc01@agccert.com.

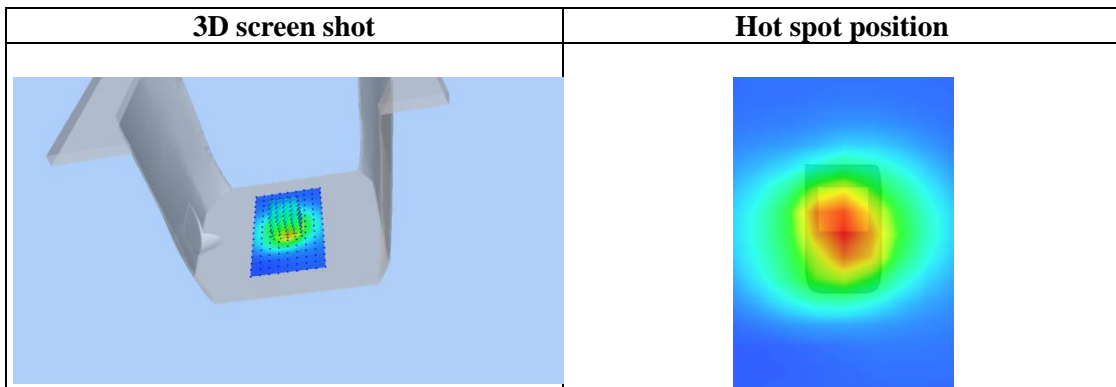
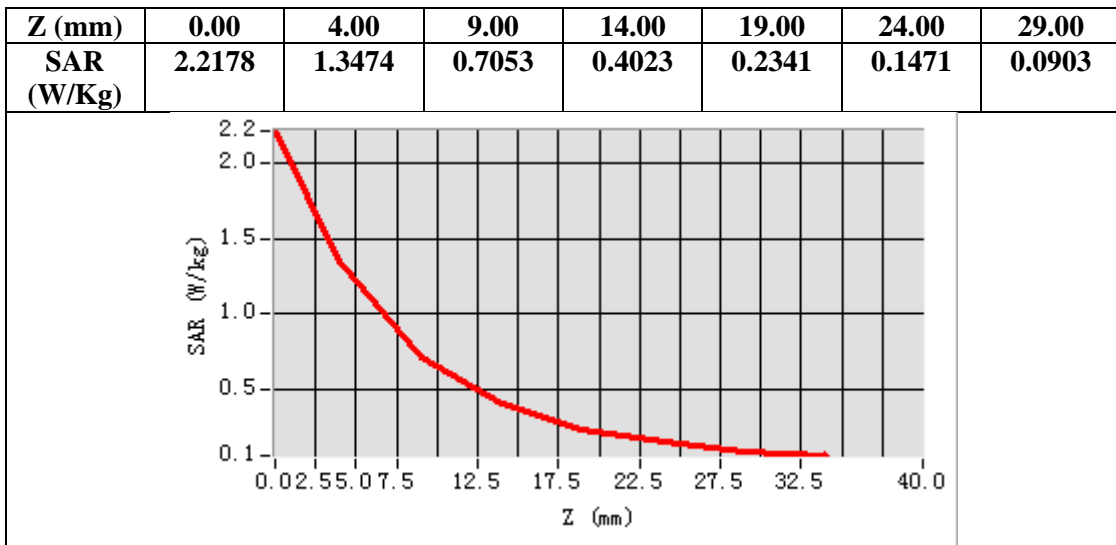

Any report having not been signed by authorized approver, or having been altered without authorization, or having not been stamped by the “Dedicated Testing/Inspection Stamp” is deemed to be invalid. Copying or excerpting portion of, or altering the content of the report is not permitted without the written authorization of AGC. The test results presented in the report apply only to the tested sample. Any objections to report issued by AGC should be submitted to AGC within 15days after the issuance of the test report. Further enquiry of validity or verification of the test report should be addressed to AGC by agc01@agccert.com.

**Test Laboratory: AGC Lab**  
**LTE Band 5 High-Edge 3(Bottom) (1 RB#0)**  
**DUT: Body Worn Camera ; Type: K7**

**Date: Dec. 05, 2023**

Communication System: LTE; Communication System Band: LTE Band 5; Duty Cycle:1:1; Conv.F=2.02  
Frequency: 844 MHz; Medium parameters used:  $f = 835$  MHz;  $\sigma=0.95$  mho/m;  $\epsilon_r=39.10$ ;  $\rho= 1000$  kg/m<sup>3</sup> ;  
Phantom section: Flat Section  
Ambient temperature (°C): 22.4, Liquid temperature (°C): 21.7

**SATIMO Configuration:**

Probe: SSE2; Calibrated: May 31, 2023; Serial No.: 2023-EPGO-414  
Sensor-Surface: 4mm (Mechanical Surface Detection)  
Phantom: SAM twin phantom  
Measurement SW: OpenSAR V4\_02\_32

**Configuration/ LTE Band 5 High-Edge 3(Bottom)/Area Scan:** Measurement grid: dx=8mm, dy=8mm  
**Configuration/ LTE Band 5 High-Edge 3(Bottom)/Zoom Scan:** Measurement grid: dx=8mm,dy=8mm, dz=5m;

<b>Area Scan</b>	surf_sam_plan.txt, h= 5.00 mm
<b>Zoom Scan</b>	5x5x7,dx=8mm dy=8mm dz=5mm
<b>Phantom</b>	Validation plane
<b>Device Position</b>	Edge 3(Bottom)
<b>Band</b>	LTE Band 5
<b>Channels</b>	High
<b>Signal</b>	OFDM (Crest factor: 1.0)

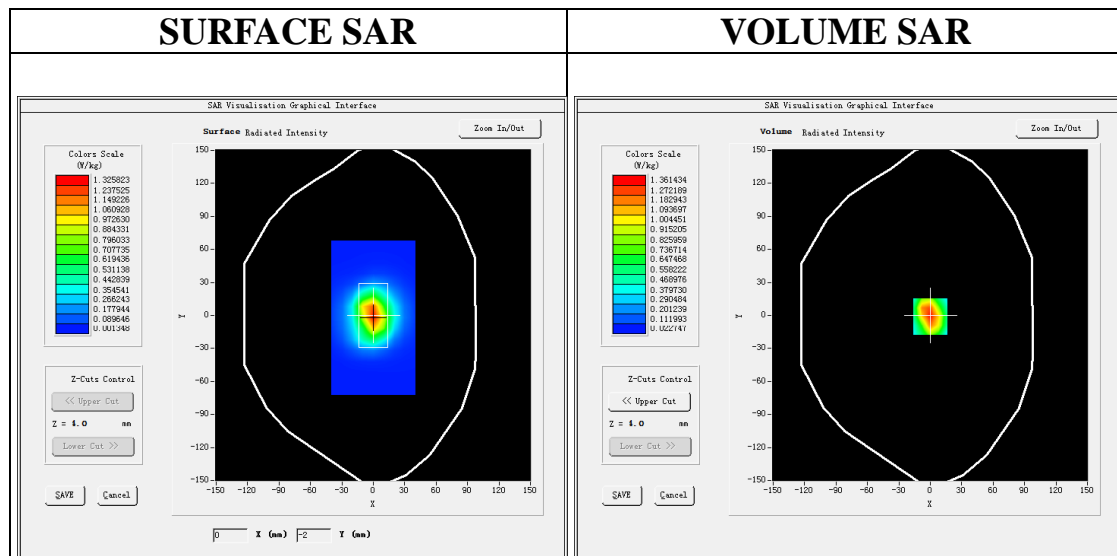

**Maximum location: X=0.00, Y=-1.00**

**SAR Peak: 2.36 W/kg**

<b>SAR 10g (W/Kg)</b>	0.646021
<b>SAR 1g (W/Kg)</b>	1.299227

Any report having not been signed by authorized approver, or having been altered without authorization, or having not been stamped by the “Dedicated Testing/Inspection Stamp” is deemed to be invalid. Copying or excerpting portion of, or altering the content of the report is not permitted without the written authorization of AGC. The test results presented in the report apply only to the tested sample. Any objections to report issued by AGC should be submitted to AGC within 15days after the issuance of the test report. Further enquiry of validity or verification of the test report should be addressed to AGC by agc01@agccert.com.

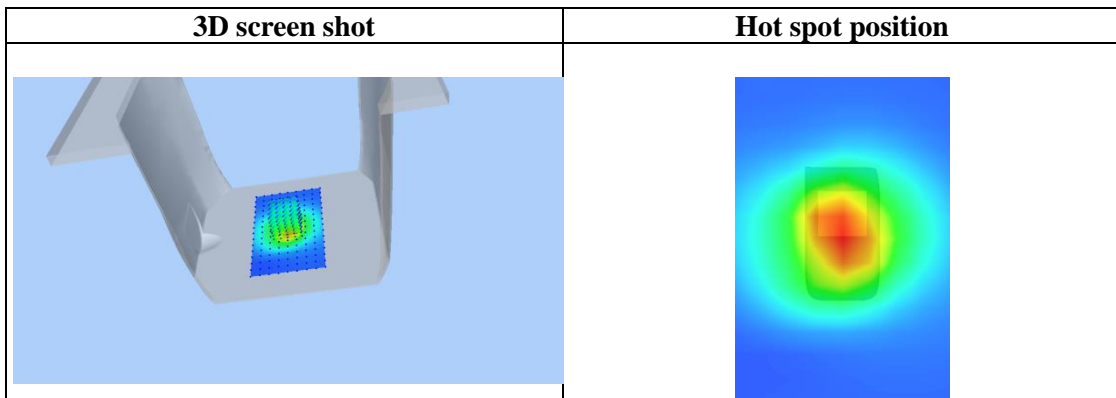
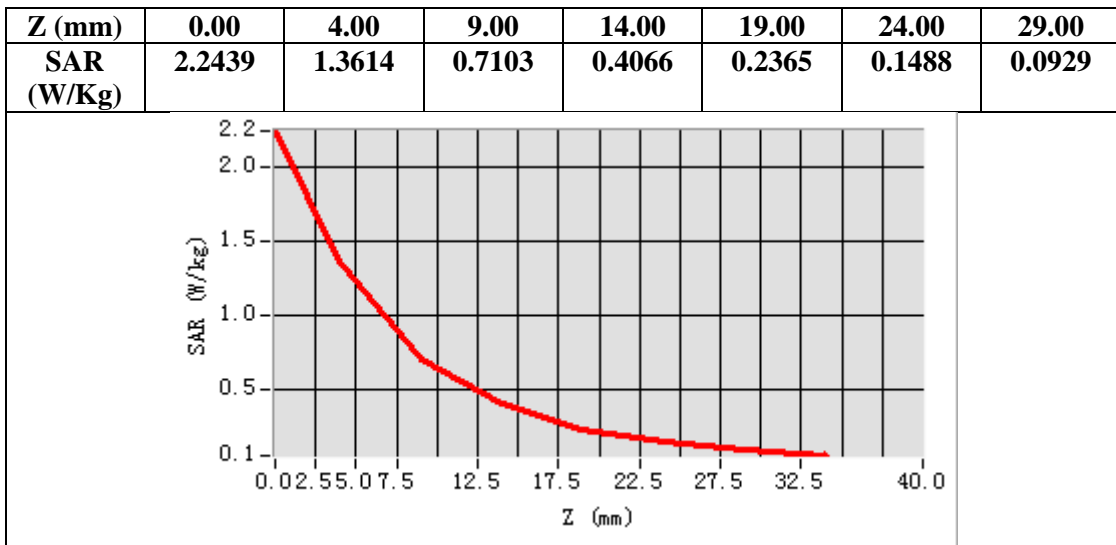

Any report having not been signed by authorized approver, or having been altered without authorization, or having not been stamped by the “Dedicated Testing/Inspection Stamp” is deemed to be invalid. Copying or excerpting portion of, or altering the content of the report is not permitted without the written authorization of AGC. The test results presented in the report apply only to the tested sample. Any objections to report issued by AGC should be submitted to AGC within 15days after the issuance of the test report. Further enquiry of validity or verification of the test report should be addressed to AGC by agc01@agccert.com.

**Test Laboratory: AGC Lab**  
**LTE Band 12 Low-Edge 3(Bottom) (1 RB#0)**  
**DUT: Body Worn Camera ; Type: K7**

**Date: Dec. 09, 2023**

Communication System: LTE; Communication System Band: LTE Band 12; Duty Cycle:1:1; Conv.F=1.95;  
Frequency: 704 MHz; Medium parameters used:  $f = 750$  MHz;  $\sigma=0.82$  mho/m;  $\epsilon_r = 41.68$ ;  $\rho= 1000$  kg/m<sup>3</sup> ;  
Phantom section: Flat Section  
Ambient temperature (°C): 20.8, Liquid temperature (°C): 20.5

**SATIMO Configuration:**

Probe: SSE2; Calibrated: May 31, 2023; Serial No.: 2023-EPGO-414  
Sensor-Surface: 4mm (Mechanical Surface Detection)  
Phantom: SAM twin phantom  
Measurement SW: OpenSAR V4\_02\_32

**Configuration/ LTE Band 12 Low-Edge 3(Bottom)/Area Scan:** Measurement grid: dx=8mm, dy=8mm  
**Configuration/ LTE Band 12 Low-Edge 3(Bottom)/Zoom Scan:** Measurement grid: dx=8mm,dy=8mm, dz=5m;

<b>Area Scan</b>	surf_sam_plan.txt, h= 5.00 mm
<b>Zoom Scan</b>	5x5x7,dx=8mm dy=8mm dz=5mm
<b>Phantom</b>	Validation plane
<b>Device Position</b>	Edge 3(Bottom)
<b>Band</b>	LTE Band 12
<b>Channels</b>	Low
<b>Signal</b>	OFDM (Crest factor: 1.0)

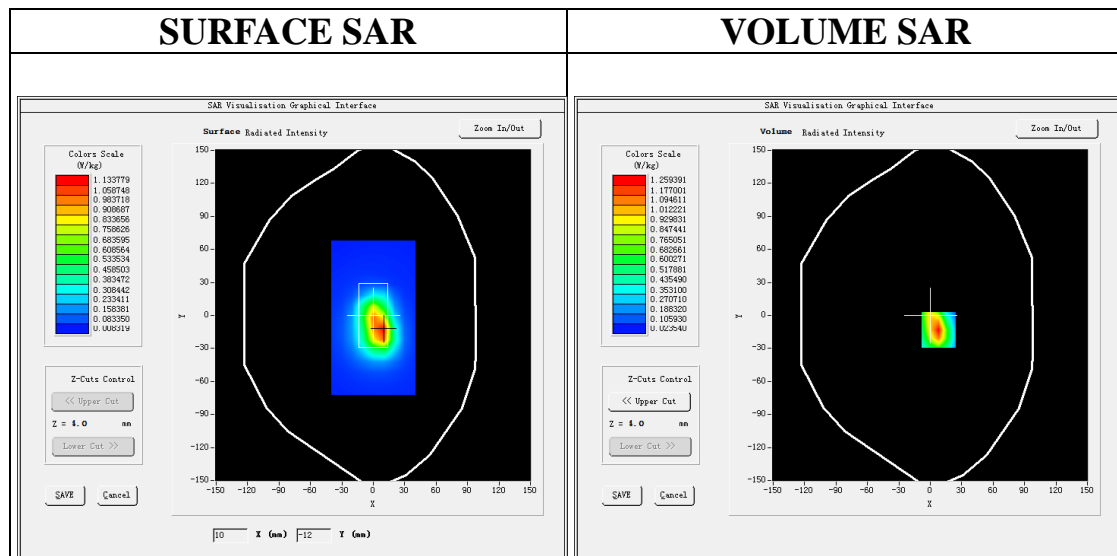

**Maximum location: X=8.00, Y=-13.00**

**SAR Peak: 2.21 W/kg**

<b>SAR 10g (W/Kg)</b>	0.590734
<b>SAR 1g (W/Kg)</b>	1.205560

Any report having not been signed by authorized approver, or having been altered without authorization, or having not been stamped by the “Dedicated Testing/Inspection Stamp” is deemed to be invalid. Copying or excerpting portion of, or altering the content of the report is not permitted without the written authorization of AGC. The test results presented in the report apply only to the tested sample. Any objections to report issued by AGC should be submitted to AGC within 15days after the issuance of the test report. Further enquiry of validity or verification of the test report should be addressed to AGC by agc01@agccert.com.

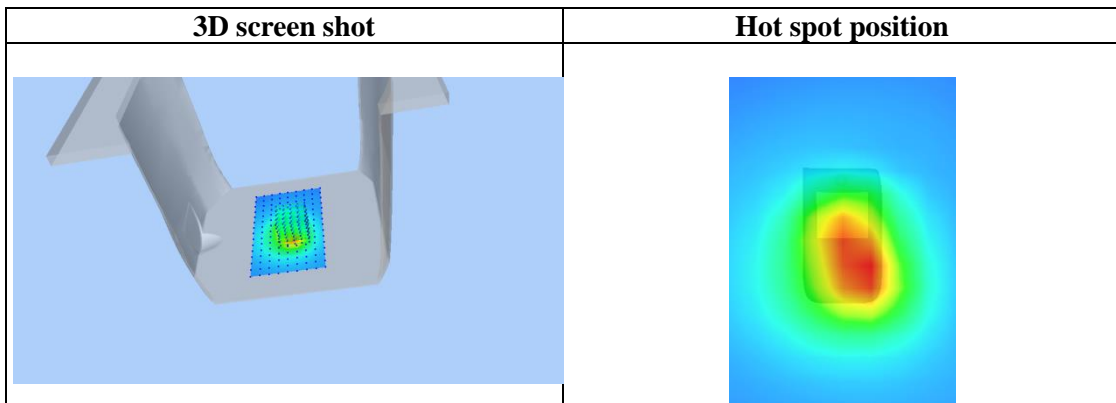
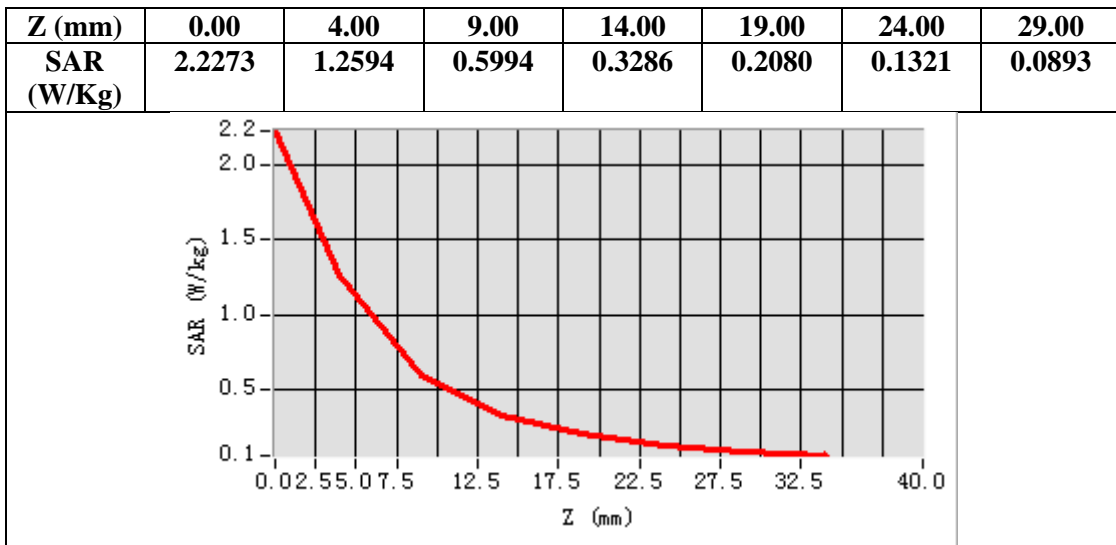

Any report having not been signed by authorized approver, or having been altered without authorization, or having not been stamped by the “Dedicated Testing/Inspection Stamp” is deemed to be invalid. Copying or excerpting portion of, or altering the content of the report is not permitted without the written authorization of AGC. The test results presented in the report apply only to the tested sample. Any objections to report issued by AGC should be submitted to AGC within 15days after the issuance of the test report. Further enquiry of validity or verification of the test report should be addressed to AGC by agc01@agccert.com.



**Test Laboratory: AGC Lab**  
**LTE Band 13 Mid-Edge 3(Bottom) (1 RB#0)**  
**DUT: Body Worn Camera ; Type: K7**

**Date: Dec. 09, 2023**

Communication System: LTE; Communication System Band: LTE Band 13; Duty Cycle:1:1; Conv.F=1.95;  
Frequency: 782 MHz; Medium parameters used:  $f = 750$  MHz;  $\sigma=0.89$  mho/m;  $\epsilon_r = 39.61$ ;  $\rho = 1000$  kg/m<sup>3</sup> ;  
Phantom section: Flat Section  
Ambient temperature (°C): 20.8, Liquid temperature (°C): 20.5

**SATIMO Configuration:**

Probe: SSE2; Calibrated: May 31, 2023; Serial No.: 2023-EPGO-414  
Sensor-Surface: 4mm (Mechanical Surface Detection)  
Phantom: SAM twin phantom  
Measurement SW: OpenSAR V4\_02\_32

**Configuration/ LTE Band 13 Mid-Edge 3(Bottom)/Area Scan:** Measurement grid: dx=8mm, dy=8mm  
**Configuration/ LTE Band 13 Mid-Edge 3(Bottom)/Zoom Scan:** Measurement grid: dx=8mm,dy=8mm, dz=5m;

<b>Area Scan</b>	surf_sam_plan.txt, h= 5.00 mm
<b>Zoom Scan</b>	5x5x7,dx=8mm dy=8mm dz=5mm
<b>Phantom</b>	Validation plane
<b>Device Position</b>	Edge 3(Bottom)
<b>Band</b>	LTE Band 13
<b>Channels</b>	Middle
<b>Signal</b>	OFDM (Crest factor: 1.0)

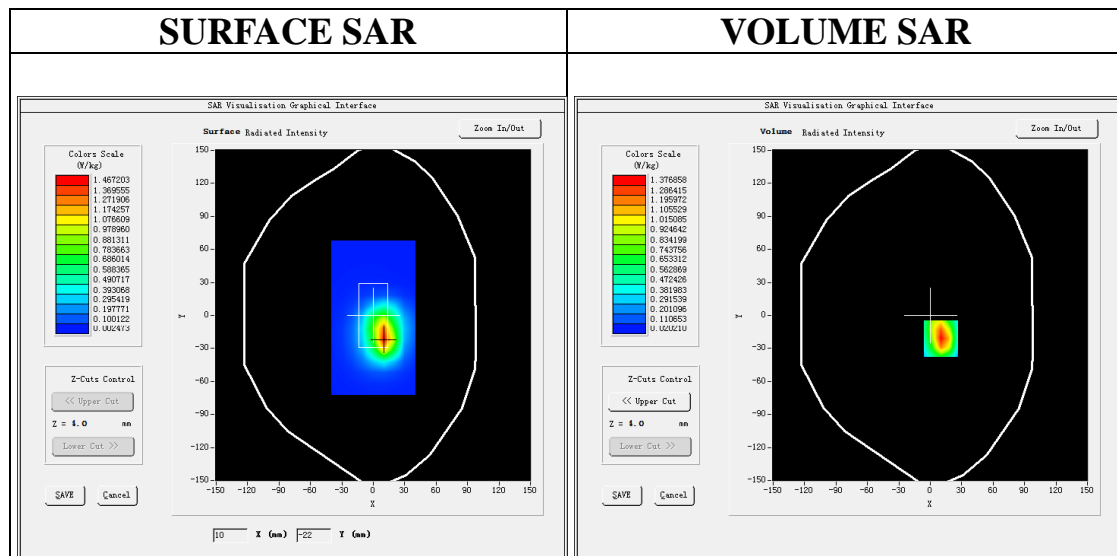

**Maximum location: X=10.00, Y=-21.00**

**SAR Peak: 2.39 W/kg**

<b>SAR 10g (W/Kg)</b>	0.646765
<b>SAR 1g (W/Kg)</b>	1.314890

Any report having not been signed by authorized approver, or having been altered without authorization, or having not been stamped by the "Dedicated Testing/Inspection Stamp" is deemed to be invalid. Copying or excerpting portion of, or altering the content of the report is not permitted without the written authorization of AGC. The test results presented in the report apply only to the tested sample. Any objections to report issued by AGC should be submitted to AGC within 15days after the issuance of the test report. Further enquiry of validity or verification of the test report should be addressed to AGC by agc01@agccert.com.

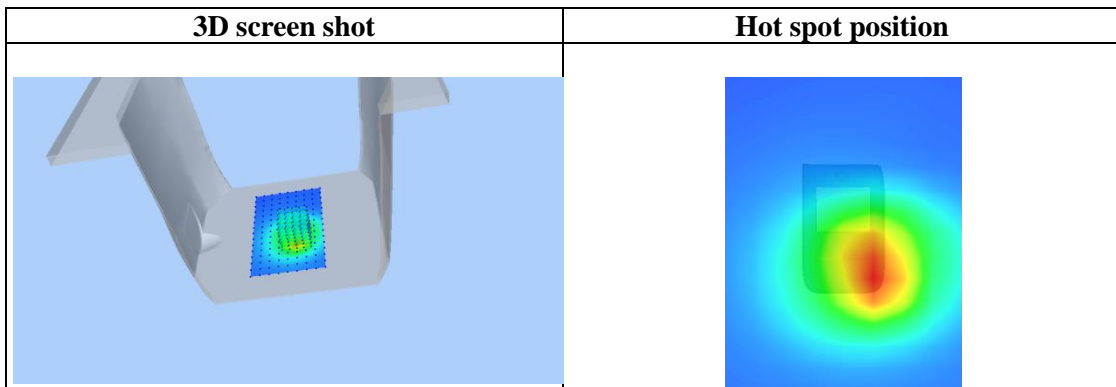
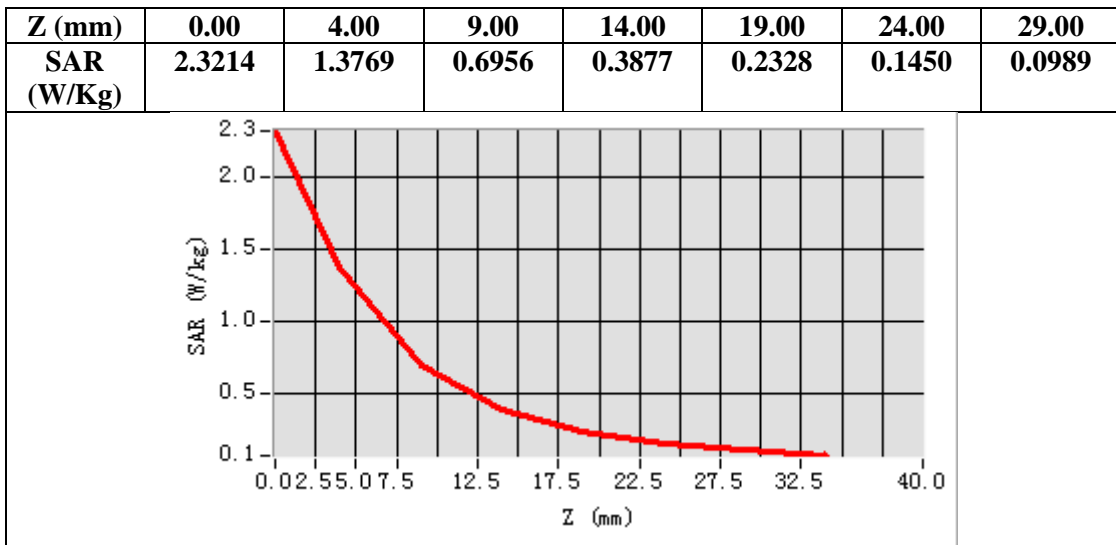

Any report having not been signed by authorized approver, or having been altered without authorization, or having not been stamped by the “Dedicated Testing/Inspection Stamp” is deemed to be invalid. Copying or excerpting portion of, or altering the content of the report is not permitted without the written authorization of AGC. The test results presented in the report apply only to the tested sample. Any objections to report issued by AGC should be submitted to AGC within 15days after the issuance of the test report. Further enquiry of validity or verification of the test report should be addressed to AGC by agc01@agccert.com.

**Test Laboratory: AGC Lab**  
**LTE Band 14 Mid-Edge 3(Bottom) (1 RB#0)**  
**DUT: Body Worn Camera ; Type: K7**

**Date: Dec. 09, 2023**

Communication System: LTE; Communication System Band: LTE Band 14; Duty Cycle:1:1; Conv.F=1.95;  
Frequency: 793 MHz; Medium parameters used:  $f = 750$  MHz;  $\sigma=0.91$  mho/m;  $\epsilon_r = 38.43$ ;  $\rho = 1000$  kg/m<sup>3</sup> ;  
Phantom section: Flat Section  
Ambient temperature (°C): 20.8, Liquid temperature (°C): 20.5

**SATIMO Configuration:**

Probe: SSE2; Calibrated: May 31, 2023; Serial No.: 2023-EPGO-414  
Sensor-Surface: 4mm (Mechanical Surface Detection)  
Phantom: SAM twin phantom  
Measurement SW: OpenSAR V4\_02\_32

**Configuration/ LTE Band 14 Mid-Edge 3(Bottom)/Area Scan:** Measurement grid: dx=8mm, dy=8mm  
**Configuration/ LTE Band 14 Mid-Edge 3(Bottom)/Zoom Scan:** Measurement grid: dx=8mm,dy=8mm, dz=5m;

<b>Area Scan</b>	surf_sam_plan.txt, h= 5.00 mm
<b>Zoom Scan</b>	5x5x7,dx=8mm dy=8mm dz=5mm
<b>Phantom</b>	Validation plane
<b>Device Position</b>	Edge 3(Bottom)
<b>Band</b>	LTE Band 14
<b>Channels</b>	Middle
<b>Signal</b>	OFDM (Crest factor: 1.0)

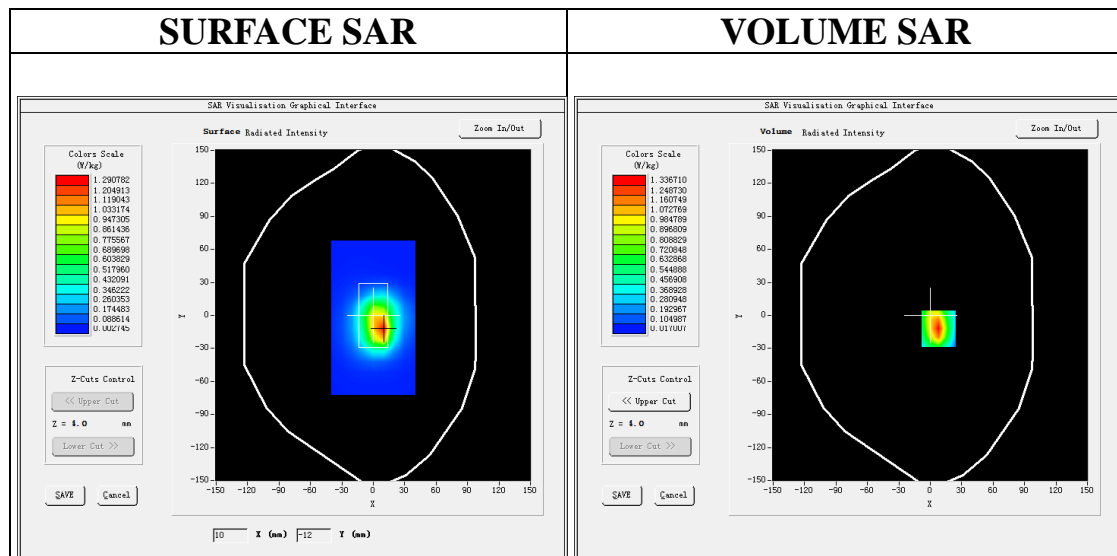

**Maximum location: X=8.00, Y=-12.00**

**SAR Peak: 2.33 W/kg**

<b>SAR 10g (W/Kg)</b>	0.607383
<b>SAR 1g (W/Kg)</b>	1.248178

Any report having not been signed by authorized approver, or having been altered without authorization, or having not been stamped by the “Dedicated Testing/Inspection Stamp” is deemed to be invalid. Copying or excerpting portion of, or altering the content of the report is not permitted without the written authorization of AGC. The test results presented in the report apply only to the tested sample. Any objections to report issued by AGC should be submitted to AGC within 15days after the issuance of the test report. Further enquiry of validity or verification of the test report should be addressed to AGC by agc01@agccert.com.

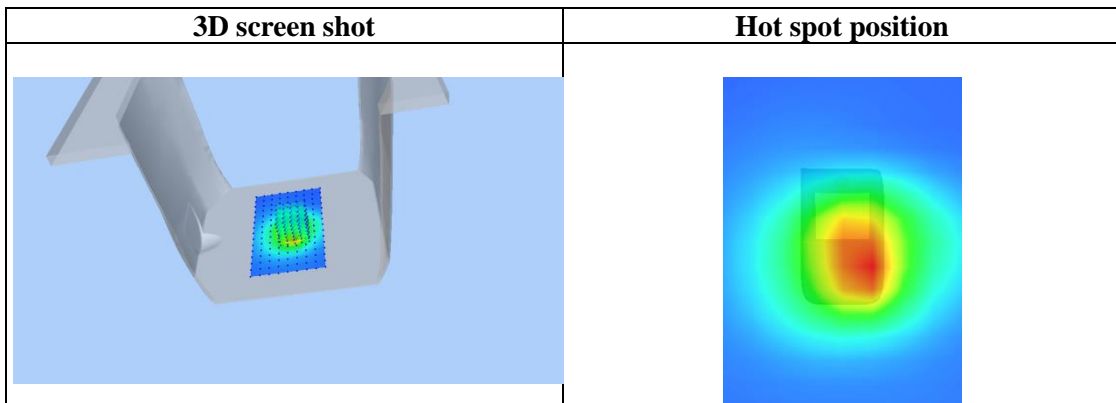
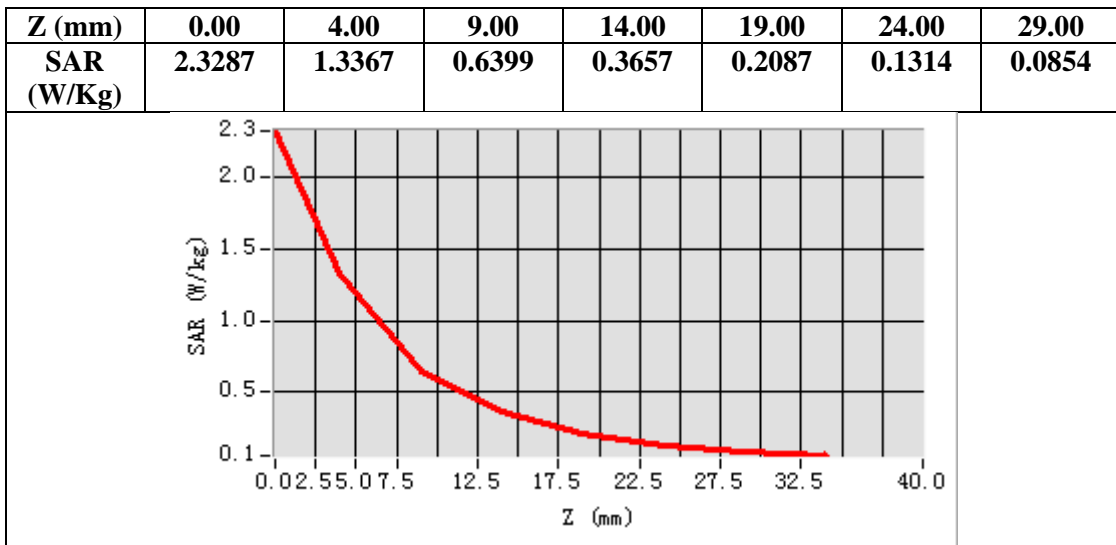

Any report having not been signed by authorized approver, or having been altered without authorization, or having not been stamped by the “Dedicated Testing/Inspection Stamp” is deemed to be invalid. Copying or excerpting portion of, or altering the content of the report is not permitted without the written authorization of AGC. The test results presented in the report apply only to the tested sample. Any objections to report issued by AGC should be submitted to AGC within 15days after the issuance of the test report. Further enquiry of validity or verification of the test report should be addressed to AGC by agc01@agccert.com.

**Test Laboratory: AGC Lab**  
**LTE Band 66 Low-Edge 3(Bottom) (1 RB#0)**  
**DUT: Body Worn Camera ; Type: K7**

**Date: Dec. 20, 2023**

Communication System: LTE; Communication System Band: LTE Band 66; Duty Cycle:1:1; Conv.F=2.17;  
Frequency:1720 MHz; Medium parameters used:  $f = 1750$  MHz;  $\sigma = 1.33$  mho/m;  $\epsilon_r = 40.32$ ;  $\rho = 1000$  kg/m<sup>3</sup> ;  
Phantom section: Flat Section  
Ambient temperature (°C): 21.7, Liquid temperature (°C): 21.2

**SATIMO Configuration:**

Probe: SSE2; Calibrated: May 31, 2023; Serial No.: 2023-EPGO-414  
Sensor-Surface: 4mm (Mechanical Surface Detection)  
Phantom: SAM twin phantom  
Measurement SW: OpenSAR V4\_02\_32

**Configuration/ LTE Band 66 Low-Edge 3(Bottom)/Area Scan:** Measurement grid: dx=8mm, dy=8mm  
**Configuration/ LTE Band 66 Low-Edge 3(Bottom)/Zoom Scan:** Measurement grid: dx=8mm,dy=8mm, dz=5m;

<b>Area Scan</b>	surf_sam_plan.txt, h= 5.00 mm
<b>Zoom Scan</b>	5x5x7,dx=8mm dy=8mm dz=5mm
<b>Phantom</b>	Validation plane
<b>Device Position</b>	Edge 3(Bottom)
<b>Band</b>	LTE Band 66
<b>Channels</b>	Low
<b>Signal</b>	OFDM (Crest factor: 1.0)

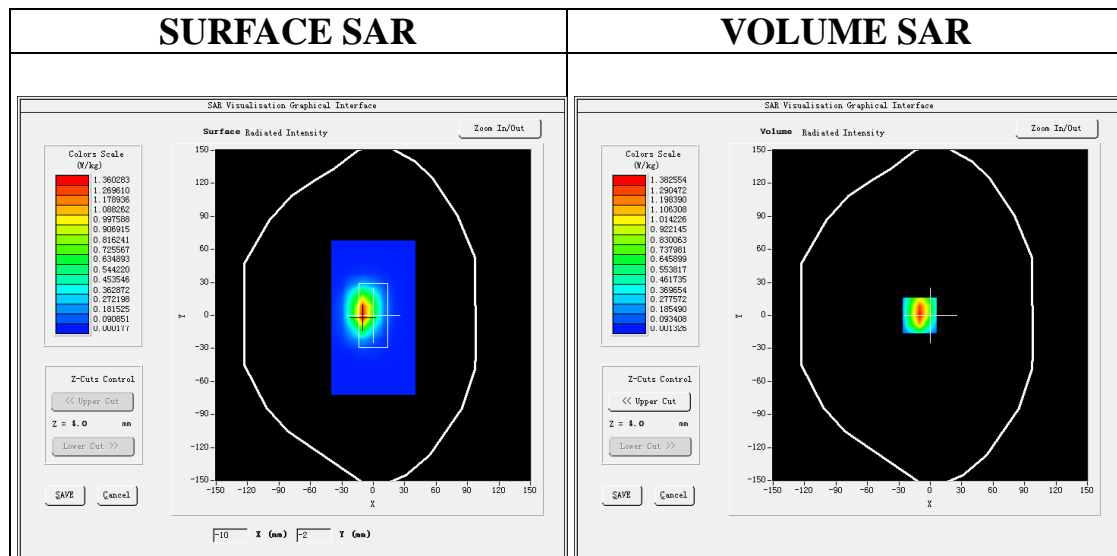

**Maximum location: X=-10.00, Y=0.00**  
**SAR Peak: 2.50 W/kg**

<b>SAR 10g (W/Kg)</b>	0.567388
<b>SAR 1g (W/Kg)</b>	1.279962

Any report having not been signed by authorized approver, or having been altered without authorization, or having not been stamped by the “Dedicated Testing/Inspection Stamp” is deemed to be invalid. Copying or excerpting portion of, or altering the content of the report is not permitted without the written authorization of AGC. The test results presented in the report apply only to the tested sample. Any objections to report issued by AGC should be submitted to AGC within 15days after the issuance of the test report. Further enquiry of validity or verification of the test report should be addressed to AGC by agc01@agccert.com.

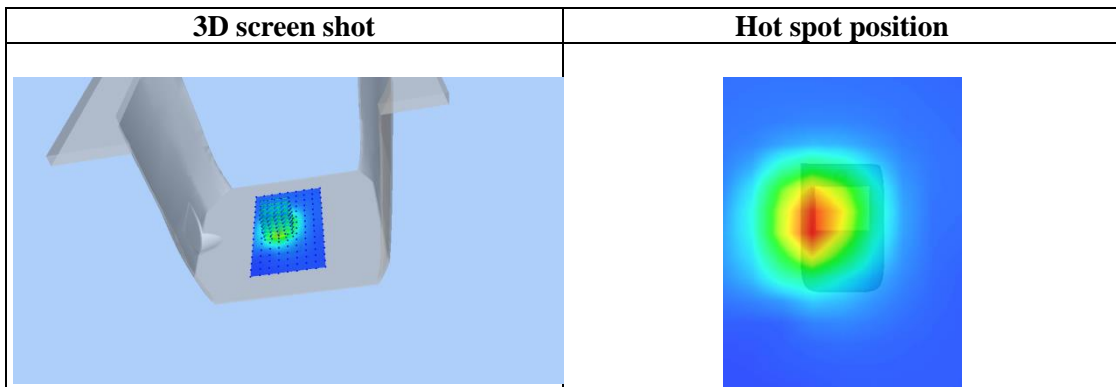
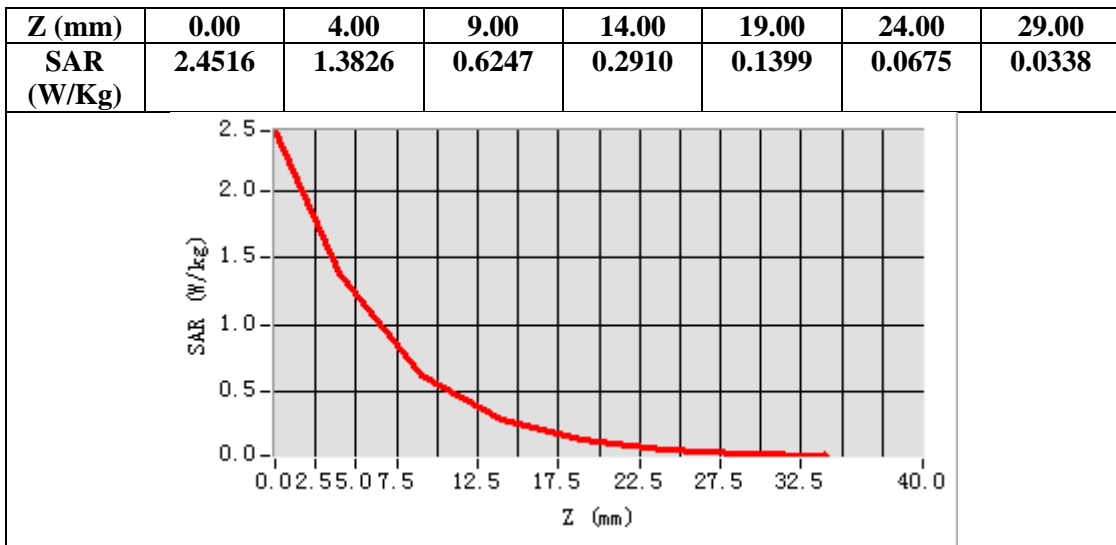

Any report having not been signed by authorized approver, or having been altered without authorization, or having not been stamped by the “Dedicated Testing/Inspection Stamp” is deemed to be invalid. Copying or excerpting portion of, or altering the content of the report is not permitted without the written authorization of AGC. The test results presented in the report apply only to the tested sample. Any objections to report issued by AGC should be submitted to AGC within 15days after the issuance of the test report. Further enquiry of validity or verification of the test report should be addressed to AGC by agc01@agccert.com.

**Test Laboratory: AGC Lab**  
**LTE Band 71 Low-Edge 3(Bottom) (1 RB#0)**  
**DUT: Body Worn Camera ; Type: K7**

**Date: Dec. 09, 2023**

Communication System: LTE; Communication System Band: LTE Band 71; Duty Cycle:1:1; Conv.F=1.95;  
Frequency: 673 MHz; Medium parameters used:  $f = 750$  MHz;  $\sigma=0.81$  mho/m;  $\epsilon_r = 44.34$ ;  $\rho = 1000$  kg/m<sup>3</sup> ;  
Phantom section: Flat Section  
Ambient temperature (°C): 20.8, Liquid temperature (°C): 20.5

**SATIMO Configuration:**

Probe: SSE2; Calibrated: May 31, 2023; Serial No.: 2023-EPGO-414  
Sensor-Surface: 4mm (Mechanical Surface Detection)  
Phantom: SAM twin phantom  
Measurement SW: OpenSAR V4\_02\_32

**Configuration/ LTE Band 71 Low-Edge 3(Bottom)/Area Scan:** Measurement grid: dx=8mm, dy=8mm  
**Configuration/ LTE Band 71 Low-Edge 3(Bottom)/Zoom Scan:** Measurement grid: dx=8mm,dy=8mm, dz=5m;

<b>Area Scan</b>	surf_sam_plan.txt, h= 5.00 mm
<b>Zoom Scan</b>	5x5x7,dx=8mm dy=8mm dz=5mm
<b>Phantom</b>	Validation plane
<b>Device Position</b>	Edge 3(Bottom)
<b>Band</b>	LTE Band 71
<b>Channels</b>	Low
<b>Signal</b>	OFDM (Crest factor: 1.0)

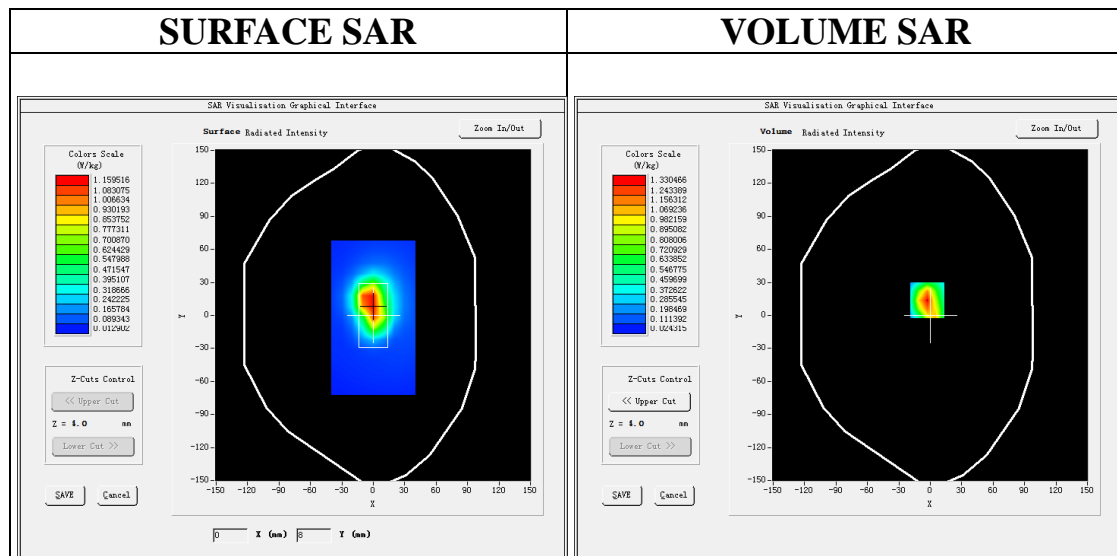

**Maximum location: X=-3.00, Y=14.00**

**SAR Peak: 2.47 W/kg**

<b>SAR 10g (W/Kg)</b>	0.630935
<b>SAR 1g (W/Kg)</b>	1.327753

Any report having not been signed by authorized approver, or having been altered without authorization, or having not been stamped by the “Dedicated Testing/Inspection Stamp” is deemed to be invalid. Copying or excerpting portion of, or altering the content of the report is not permitted without the written authorization of AGC. The test results presented in the report apply only to the tested sample. Any objections to report issued by AGC should be submitted to AGC within 15days after the issuance of the test report. Further enquiry of validity or verification of the test report should be addressed to AGC by agc01@agccert.com.

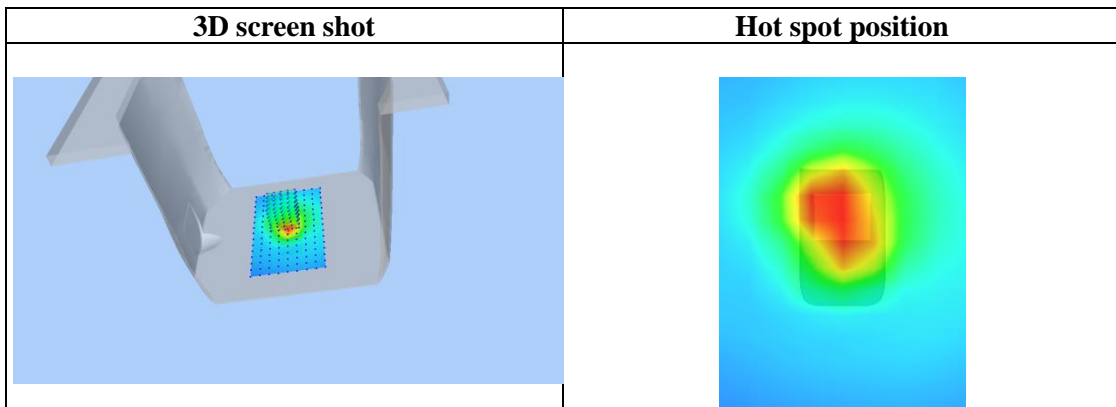
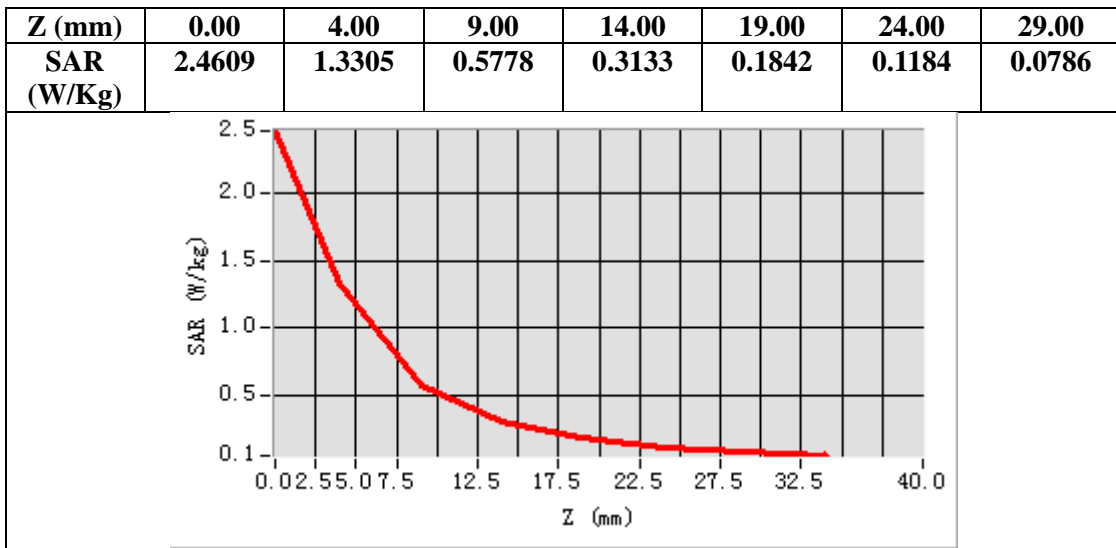

Any report having not been signed by authorized approver, or having been altered without authorization, or having not been stamped by the “Dedicated Testing/Inspection Stamp” is deemed to be invalid. Copying or excerpting portion of, or altering the content of the report is not permitted without the written authorization of AGC. The test results presented in the report apply only to the tested sample. Any objections to report issued by AGC should be submitted to AGC within 15days after the issuance of the test report. Further enquiry of validity or verification of the test report should be addressed to AGC by agc01@agccert.com.



**WIFI MODE**

Test Laboratory: AGC Lab  
802.11b Mid- Edge 2(Right)  
DUT: Body Worn Camera ; Type: K7

Date: Dec. 22, 2023

Communication System: Wi-Fi; Communication System Band: 802.11b; Duty Cycle: 1:1; Conv.F=2.29;  
Frequency: 2437 MHz; Medium parameters used:  $f = 2450$  MHz;  $\sigma = 1.79$  mho/m;  $\epsilon_r = 40.36$ ;  $\rho = 1000$  kg/m<sup>3</sup> ;  
Phantom section: Flat Section  
Ambient temperature (°C):21.1, Liquid temperature (°C): 20.8

SATIMO Configuration:

Probe: SSE2; Calibrated: May 31, 2023; Serial No.: 2023-EPGO-414  
Sensor-Surface: 4mm (Mechanical Surface Detection)  
Phantom: SAM twin phantom  
Measurement SW: OpenSAR V4\_02\_32

Configuration/802.11b Mid- Edge 2(Right) /Area Scan: Measurement grid: dx=8mm, dy=8mm  
Configuration/802.11b Mid- Edge 2(Right) /Zoom Scan: Measurement grid: dx=5mm,dy=5mm, dz=5mm;

Area Scan	surf_sam_plan.txt, h= 5.00 mm
ZoomScan	7x7x7,dx=5mm dy=5mm dz=5mm
Phantom	Validation plane
Device Position	Edge 2(Right)
Band	2450MHz
Channels	Middle
Signal	Crest factor: 1.0

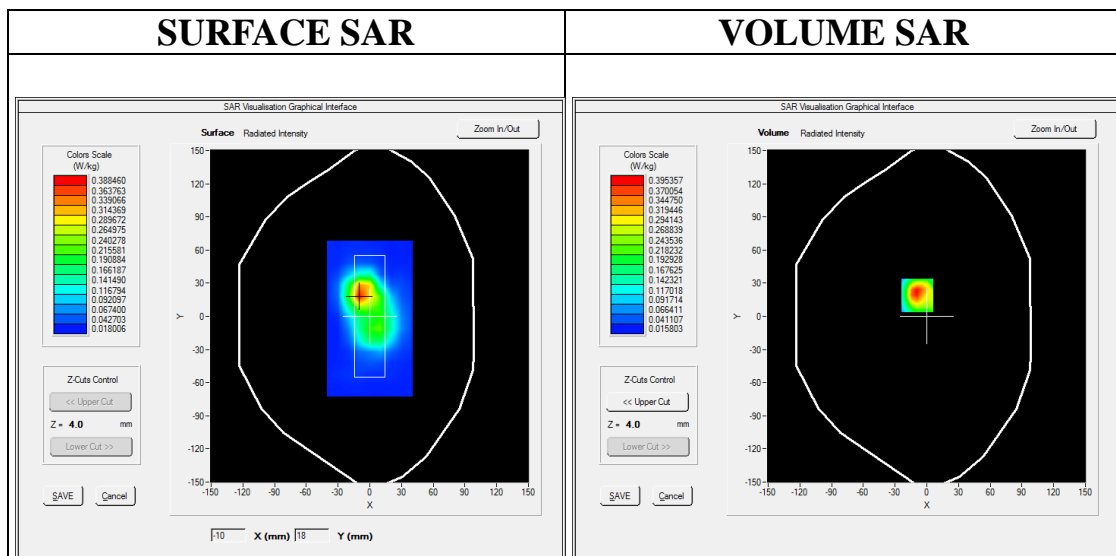

**Maximum location: X=-9.00, Y=19.00**  
**SAR Peak: 0.74 W/kg**

SAR 10g (W/Kg)	0.164710
SAR 1g (W/Kg)	0.369332

Any report having not been signed by authorized approver, or having been altered without authorization, or having not been stamped by the “Dedicated Testing/Inspection Stamp” is deemed to be invalid. Copying or excerpting portion of, or altering the content of the report is not permitted without the written authorization of AGC. The test results presented in the report apply only to the tested sample. Any objections to report issued by AGC should be submitted to AGC within 15days after the issuance of the test report. Further enquiry of validity or verification of the test report should be addressed to AGC by agc01@agccert.com.

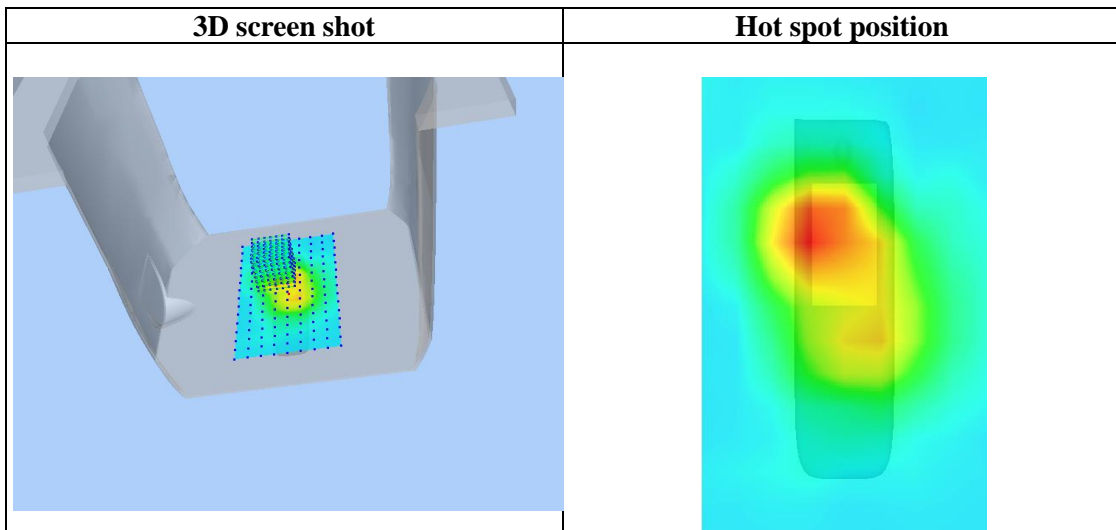
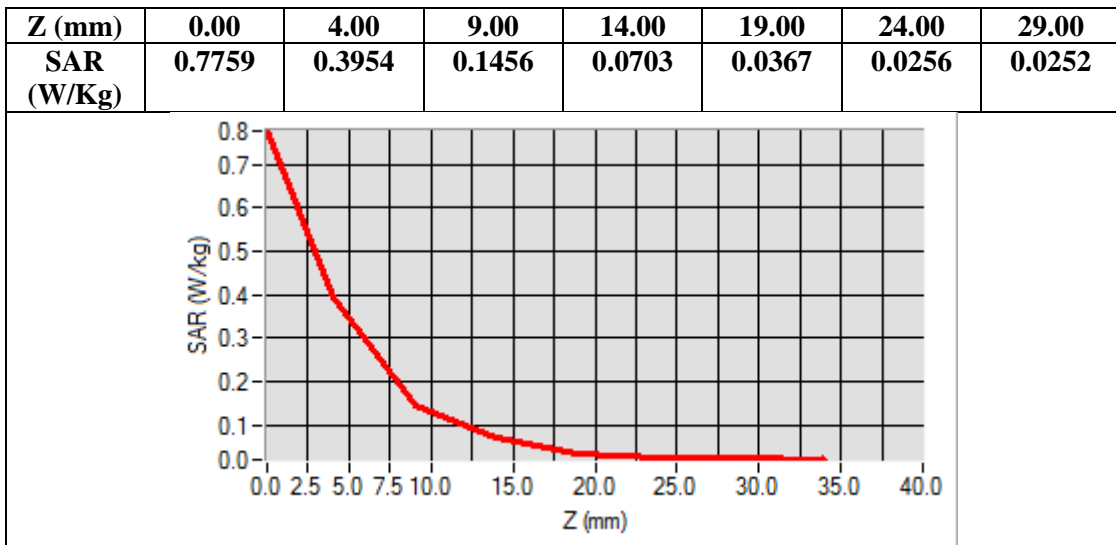

Any report having not been signed by authorized approver, or having been altered without authorization, or having not been stamped by the “Dedicated Testing/Inspection Stamp” is deemed to be invalid. Copying or excerpting portion of, or altering the content of the report is not permitted without the written authorization of AGC. The test results presented in the report apply only to the tested sample. Any objections to report issued by AGC should be submitted to AGC within 15days after the issuance of the test report. Further enquiry of validity or verification of the test report should be addressed to AGC by agc01@agccert.com.

**5.2GHz 802.11a**

**Test Laboratory: AGC Lab**

**802.11a CH40- Body-Front**

**DUT: Body Worn Camera ; Type: K7**

**Date: Dec. 13, 2023**

Communication System: Wi-Fi; Communication System Band: 802.11a; Duty Cycle: 1:1; Conv.F=2.35;  
Frequency: 5200MHz; Medium parameters used:  $f = 5200$  MHz;  $\sigma = 4.50$  mho/m;  $\epsilon_r = 36.21$ ;  $\rho = 1000$  kg/m<sup>3</sup> ;  
Phantom section: Flat Section  
Ambient temperature (°C): 20.1, Liquid temperature (°C): 19.8

**SATIMO Configuration:**

Probe: SSE2; Calibrated: May 31, 2023; Serial No.: 2023-EPGO-414

Sensor-Surface: 4mm (Mechanical Surface Detection)

Phantom: SAM twin phantom

Measurement SW: OpenSAR V4\_02\_32

**Configuration/802.11a CH40- Body-Front/Area Scan:** Measurement grid: dx=8mm, dy=8mm

**Configuration/802.11a CH40- Body-Front/Zoom Scan:** Measurement grid: dx=4mm,dy=4mm, dz=2mm

<b>Area Scan</b>	sam_direct_droit2_surf8mm.txt
<b>ZoomScan</b>	7x7x12 dx=4mm dy=4mm dz=2mm
<b>Phantom</b>	Validation plane
<b>Device Position</b>	Body Front
<b>Band</b>	5200MHz
<b>Channels</b>	CH40
<b>Signal</b>	Crest factor: 1.0

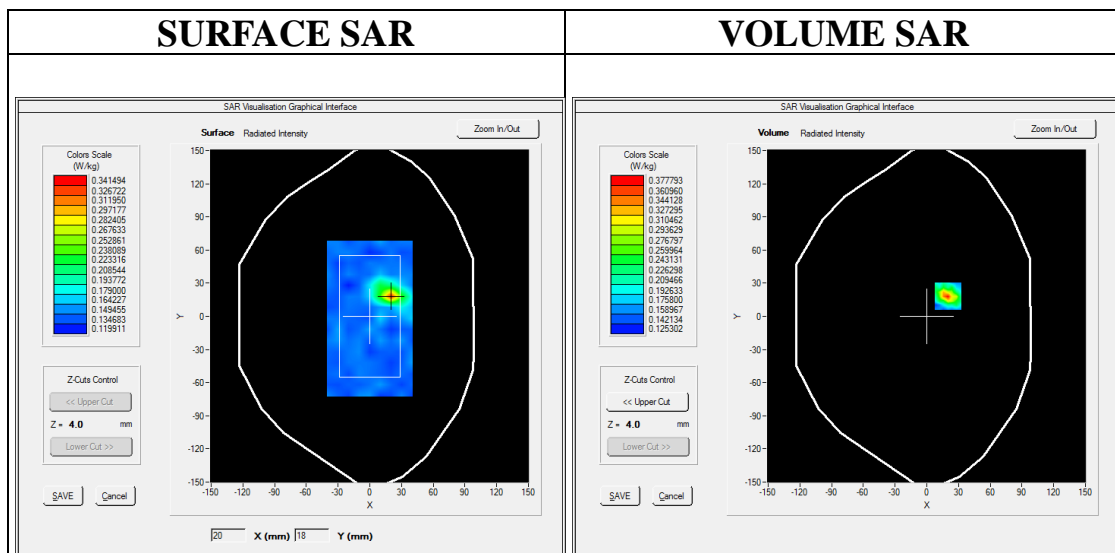

**Maximum location: X=20.00, Y=18.00**  
**SAR Peak: 0.92 W/kg**

<b>SAR 10g (W/Kg)</b>	0.198845
<b>SAR 1g (W/Kg)</b>	0.348409

Any report having not been signed by authorized approver, or having been altered without authorization, or having not been stamped by the "Dedicated Testing/Inspection Stamp" is deemed to be invalid. Copying or excerpting portion of, or altering the content of the report is not permitted without the written authorization of AGC. The test results presented in the report apply only to the tested sample. Any objections to report issued by AGC should be submitted to AGC within 15days after the issuance of the test report. Further enquiry of validity or verification of the test report should be addressed to AGC by agc01@agccert.com.

Attestation of Global Compliance(Shenzhen)Co., Ltd

Attestation of Global Compliance(Shenzhen)Std & Tech Co., Ltd

Tel: +86-755 2523 4088 E-mail: agc@agccert.com Web: http://www.agccert.com/

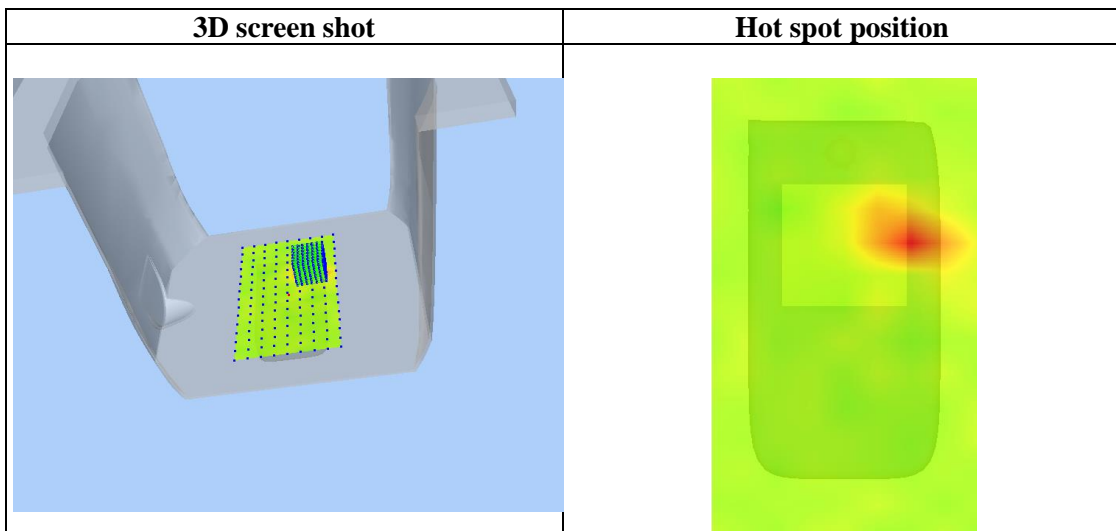
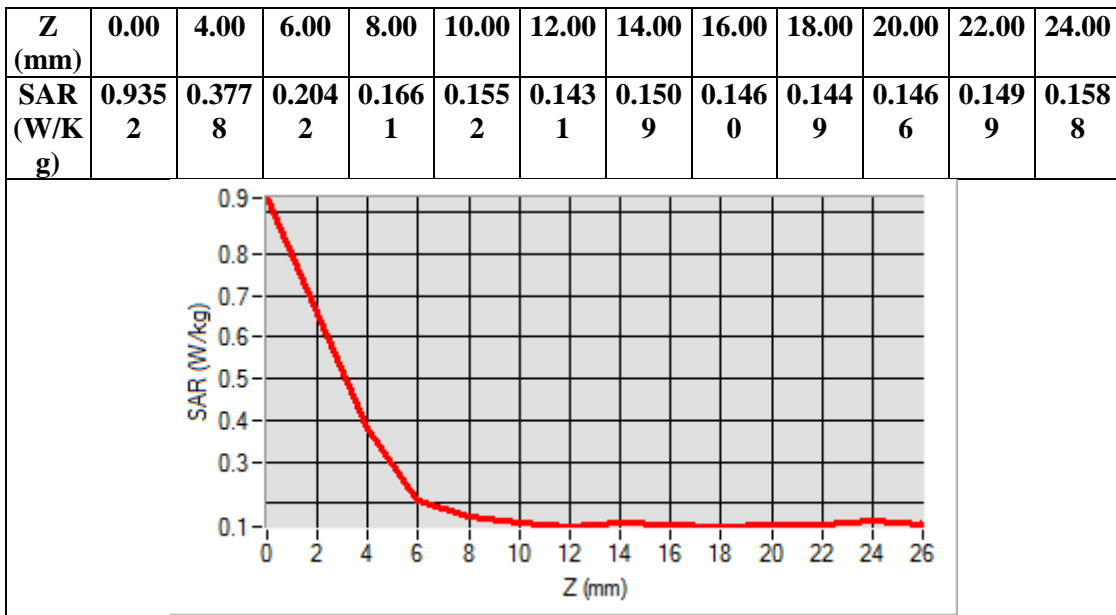

Any report having not been signed by authorized approver, or having been altered without authorization, or having not been stamped by the “Dedicated Testing/Inspection Stamp” is deemed to be invalid. Copying or excerpting portion of, or altering the content of the report is not permitted without the written authorization of AGC. The test results presented in the report apply only to the tested sample. Any objections to report issued by AGC should be submitted to AGC within 15days after the issuance of the test report. Further enquiry of validity or verification of the test report should be addressed to AGC by agc01@agccert.com.

**5.3GHz 802.11a**

**Test Laboratory: AGC Lab**  
**802.11a CH60- Body-Front**

**Date: Dec. 14, 2023**

**DUT: Body Worn Camera ; Type: K7**

Communication System: Wi-Fi; Communication System Band: 802.11a; Duty Cycle: 1:1; Conv.F=1.35;  
Frequency: 5300MHz; Medium parameters used:  $f = 5300 \text{ MHz}$ ;  $\sigma = 4.91 \text{ mho/m}$ ;  $\epsilon_r = 36.59$ ;  $\rho = 1000 \text{ kg/m}^3$  ;  
Phantom section: Flat Section  
Ambient temperature ( $^{\circ}\text{C}$ ): 21.3, Liquid temperature ( $^{\circ}\text{C}$ ): 21.0

**SATIMO Configuration:**

Probe: SSE2; Calibrated: May 31, 2023; Serial No.: 2023-EPGO-414  
Sensor-Surface: 4mm (Mechanical Surface Detection)  
Phantom: SAM twin phantom  
Measurement SW: OpenSAR V4\_02\_32

**Configuration/802.11a CH60- Body-Front /Area Scan:** Measurement grid:  $dx=8\text{mm}$ ,  $dy=8\text{mm}$   
**Configuration/802.11a CH60- Body-Front /Zoom Scan:** Measurement grid:  $dx=4\text{mm}$ ,  $dy=4\text{mm}$ ,  $dz=2\text{mm}$

<b>Area Scan</b>	sam_direct_droit2_surf8mm.txt
<b>ZoomScan</b>	7x7x12 $dx=4\text{mm}$ $dy=4\text{mm}$ $dz=2\text{mm}$
<b>Phantom</b>	Validation plane
<b>Device Position</b>	Body Front
<b>Band</b>	5300MHz
<b>Channels</b>	CH60
<b>Signal</b>	Crest factor: 1.0

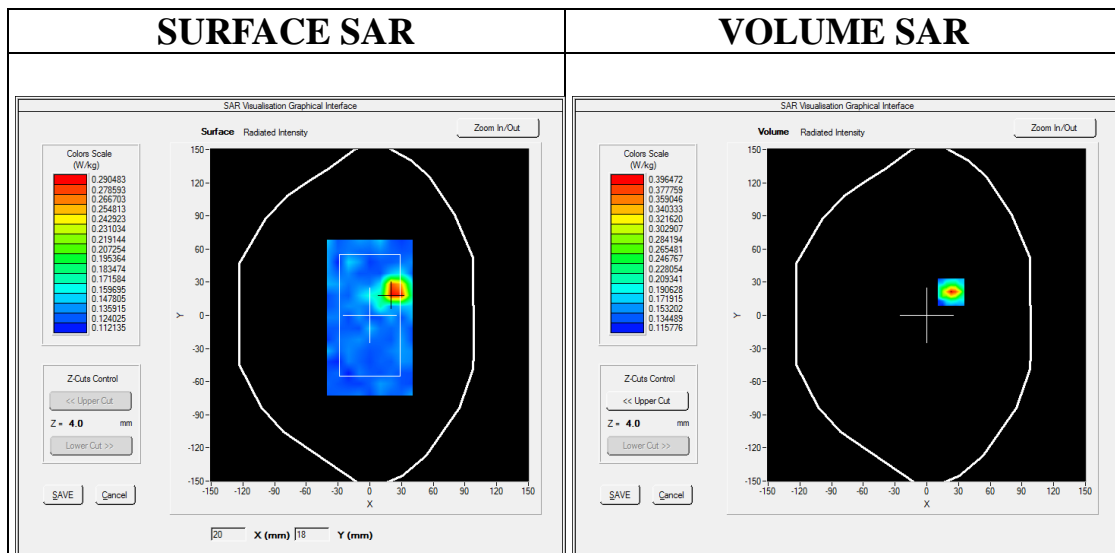

**Maximum location: X=23.00, Y=21.00**  
**SAR Peak: 0.99 W/kg**

<b>SAR 10g (W/Kg)</b>	0.193722
<b>SAR 1g (W/Kg)</b>	0.367509

Any report having not been signed by authorized approver, or having been altered without authorization, or having not been stamped by the "Dedicated Testing/Inspection Stamp" is deemed to be invalid. Copying or excerpting portion of, or altering the content of the report is not permitted without the written authorization of AGC. The test results presented in the report apply only to the tested sample. Any objections to report issued by AGC should be submitted to AGC within 15days after the issuance of the test report. Further enquiry of validity or verification of the test report should be addressed to AGC by agc01@agccert.com.

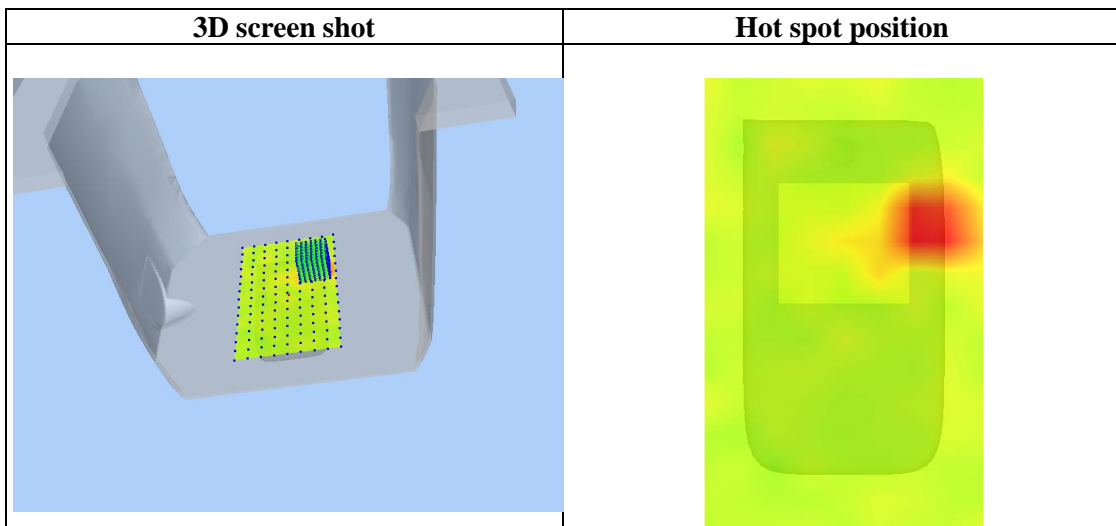
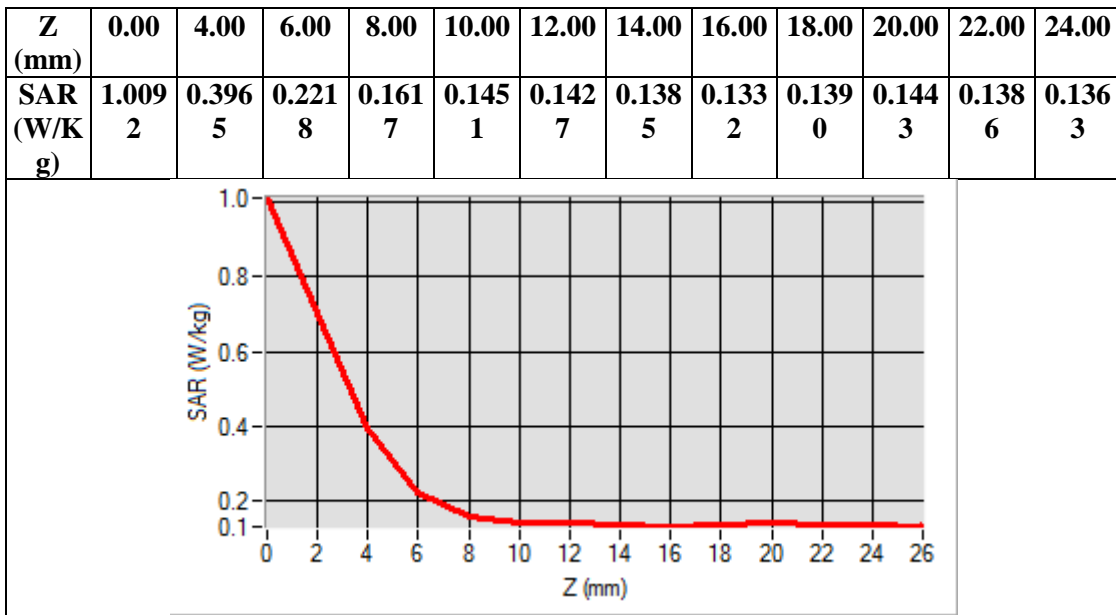

Any report having not been signed by authorized approver, or having been altered without authorization, or having not been stamped by the “Dedicated Testing/Inspection Stamp” is deemed to be invalid. Copying or excerpting portion of, or altering the content of the report is not permitted without the written authorization of AGC. The test results presented in the report apply only to the tested sample. Any objections to report issued by AGC should be submitted to AGC within 15days after the issuance of the test report. Further enquiry of validity or verification of the test report should be addressed to AGC by agc01@agccert.com.

**5.6GHz 802.11a**

Test Laboratory: AGC Lab

802.11a CH120- Body-Front

DUT: Body Worn Camera ; Type: K7

Date: Dec. 15, 2023

Communication System: Wi-Fi; Communication System Band: 802.11a; Duty Cycle: 1:1; Conv.F=2.51;  
Frequency: 5600MHz; Medium parameters used:  $f = 5600$  MHz;  $\sigma = 5.14$  mho/m;  $\epsilon_r = 36.55$ ;  $\rho = 1000$  kg/m<sup>3</sup> ;  
Phantom section: Flat Section  
Ambient temperature (°C): 21.4, Liquid temperature (°C): 21.0

SATIMO Configuration:

Probe: SSE2; Calibrated: May 31, 2023; Serial No.: 2023-EPGO-414

Sensor-Surface: 4mm (Mechanical Surface Detection)

Phantom: SAM twin phantom

Measurement SW: OpenSAR V4\_02\_32

**Configuration/802.11a CH120- Body-Front /Area Scan:** Measurement grid: dx=8mm, dy=8mm

**Configuration/802.11a CH120- Body-Front /Zoom Scan:** Measurement grid: dx=4mm,dy=4mm, dz=2mm

<b>Area Scan</b>	sam_direct_droit2_surf8mm.txt
<b>ZoomScan</b>	7x7x12 dx=4mm dy=4mm dz=2mm
<b>Phantom</b>	Validation plane
<b>Device Position</b>	Body Front
<b>Band</b>	5600MHz
<b>Channels</b>	CH120
<b>Signal</b>	Crest factor: 1.0

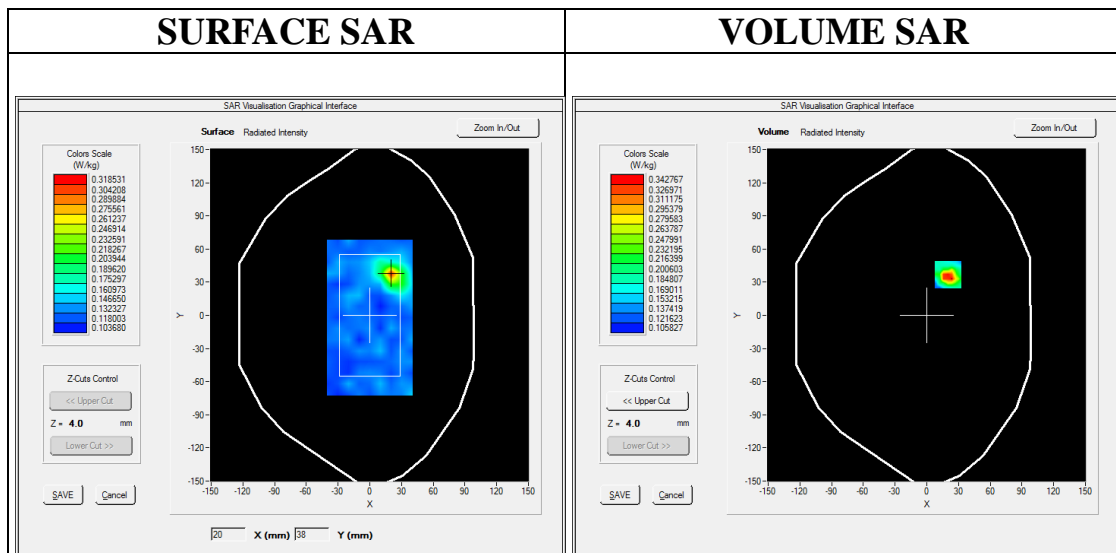

**Maximum location: X=20.00, Y=37.00**

**SAR Peak: 0.87 W/kg**

<b>SAR 10g (W/Kg)</b>	0.181858
<b>SAR 1g (W/Kg)</b>	0.327794

Any report having not been signed by authorized approver, or having been altered without authorization, or having not been stamped by the "Dedicated Testing/Inspection Stamp" is deemed to be invalid. Copying or excerpting portion of, or altering the content of the report is not permitted without the written authorization of AGC. The test results presented in the report apply only to the tested sample. Any objections to report issued by AGC should be submitted to AGC within 15days after the issuance of the test report. Further enquiry of validity or verification of the test report should be addressed to AGC by agc01@agccert.com.

Attestation of Global Compliance(Shenzhen)Co., Ltd

Attestation of Global Compliance(Shenzhen)Std & Tech Co., Ltd

Tel: +86-755 2523 4088 E-mail: agc@agccert.com Web: http://www.agccert.com/

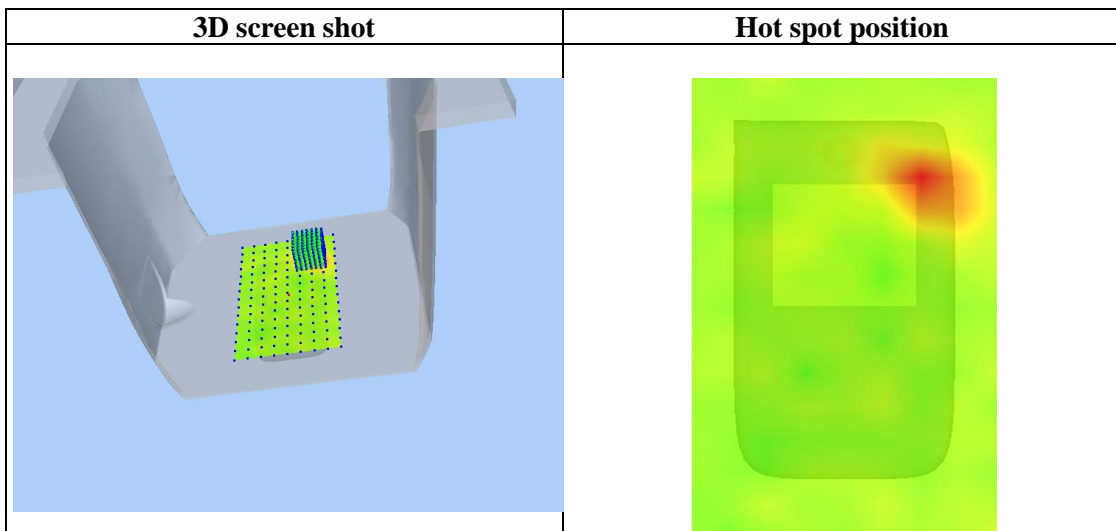
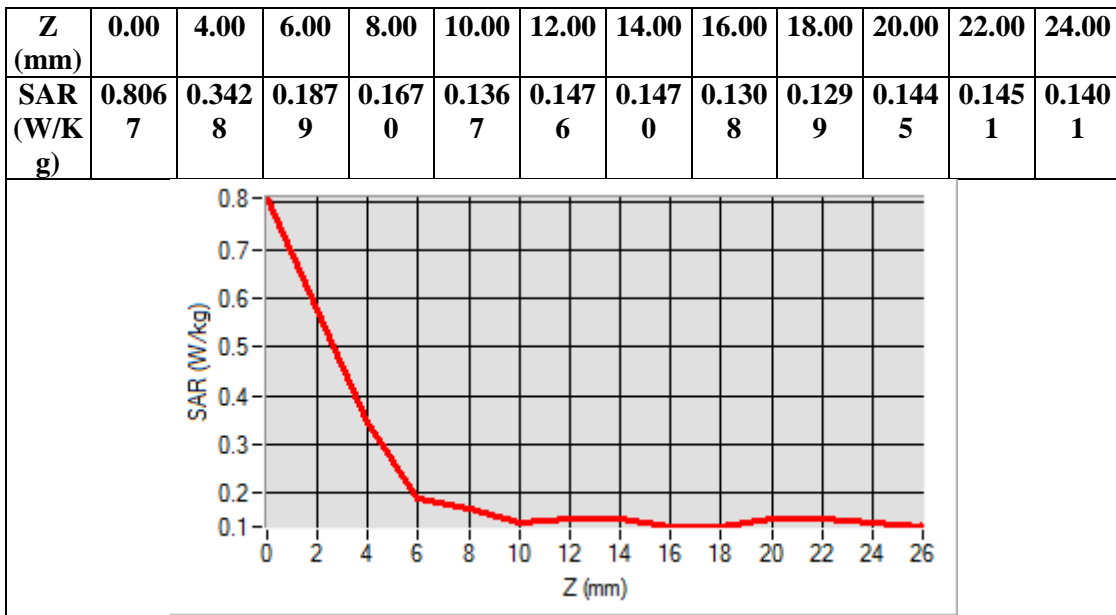

Any report having not been signed by authorized approver, or having been altered without authorization, or having not been stamped by the “Dedicated Testing/Inspection Stamp” is deemed to be invalid. Copying or excerpting portion of, or altering the content of the report is not permitted without the written authorization of AGC. The test results presented in the report apply only to the tested sample. Any objections to report issued by AGC should be submitted to AGC within 15days after the issuance of the test report. Further enquiry of validity or verification of the test report should be addressed to AGC by agc01@agccert.com.



**5.8GHz 802.11a**

Test Laboratory: AGC Lab

802.11a CH157- Body-Front

DUT: Body Worn Camera ; Type: K7

Date: Dec. 16, 2023

Communication System: Wi-Fi; Communication System Band: 802.11a; Duty Cycle: 1:1; Conv.F=1.41;  
Frequency: 5785MHz; Medium parameters used:  $f = 5800$  MHz;  $\sigma = 5.22$  mho/m;  $\epsilon_r = 36.46$ ;  $\rho = 1000$  kg/m<sup>3</sup> ;  
Phantom section: Flat Section  
Ambient temperature (°C): 21.7, Liquid temperature (°C): 21.3

SATIMO Configuration:

Probe: SSE2; Calibrated: May 31, 2023; Serial No.: 2023-EPGO-414

Sensor-Surface: 4mm (Mechanical Surface Detection)

Phantom: SAM twin phantom

Measurement SW: OpenSAR V4\_02\_32

**Configuration/ 802.11a CH157- Body-Front /Area Scan:** Measurement grid: dx=8mm, dy=8mm

**Configuration/ 802.11a CH157- Body-Front /Zoom Scan:** Measurement grid: dx=4mm,dy=4mm, dz=2mm

<b>Area Scan</b>	sam_direct_droit2_surf8mm.txt
<b>ZoomScan</b>	7x7x12 dx=4mm dy=4mm dz=2mm
<b>Phantom</b>	Validation plane
<b>Device Position</b>	Body Front
<b>Band</b>	5800MHz
<b>Channels</b>	Middle
<b>Signal</b>	Crest factor: 1.0

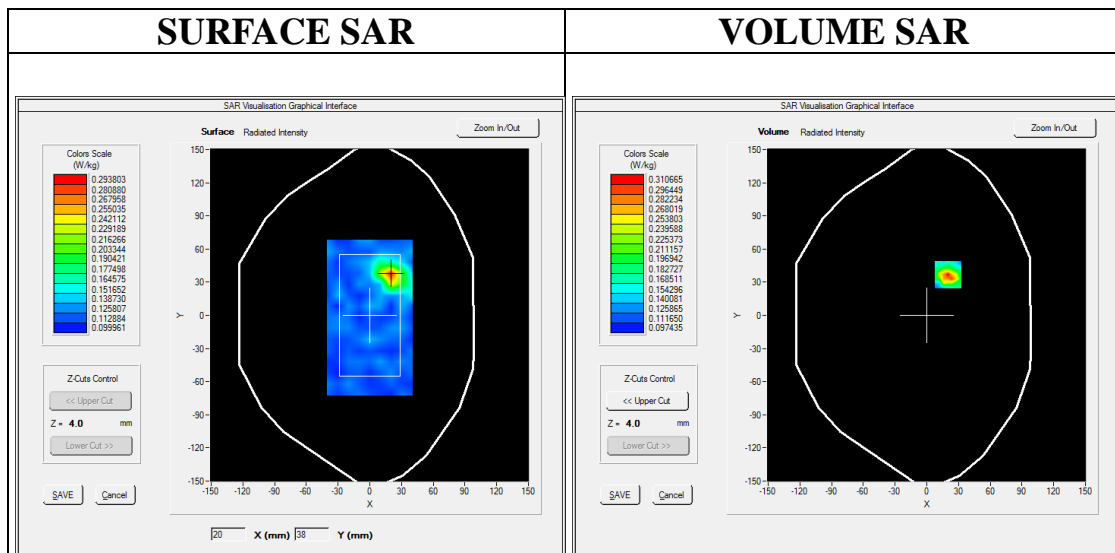

**Maximum location: X=20.00, Y=37.00**

**SAR Peak: 0.72 W/kg**

<b>SAR 10g (W/Kg)</b>	0.171034
<b>SAR 1g (W/Kg)</b>	0.292475

Any report having not been signed by authorized approver, or having been altered without authorization, or having not been stamped by the "Dedicated Testing/Inspection Stamp" is deemed to be invalid. Copying or excerpting portion of, or altering the content of the report is not permitted without the written authorization of AGC. The test results presented in the report apply only to the tested sample. Any objections to report issued by AGC should be submitted to AGC within 15days after the issuance of the test report. Further enquiry of validity or verification of the test report should be addressed to AGC by agc01@agccert.com.

Attestation of Global Compliance(Shenzhen)Co., Ltd

Attestation of Global Compliance(Shenzhen)Std & Tech Co., Ltd

Tel: +86-755 2523 4088 E-mail: agc@agccert.com Web: http://www.agccert.com/

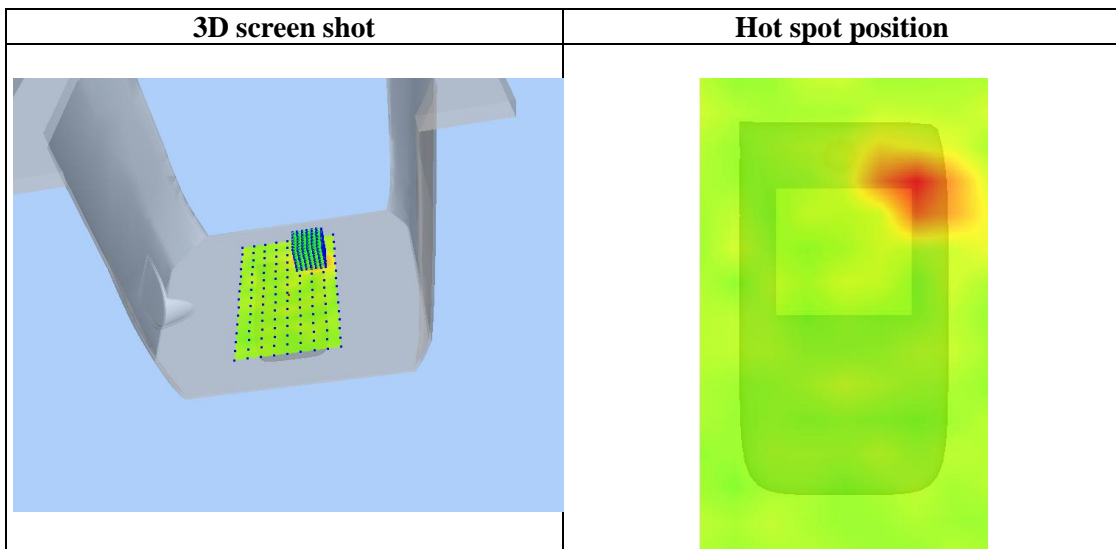
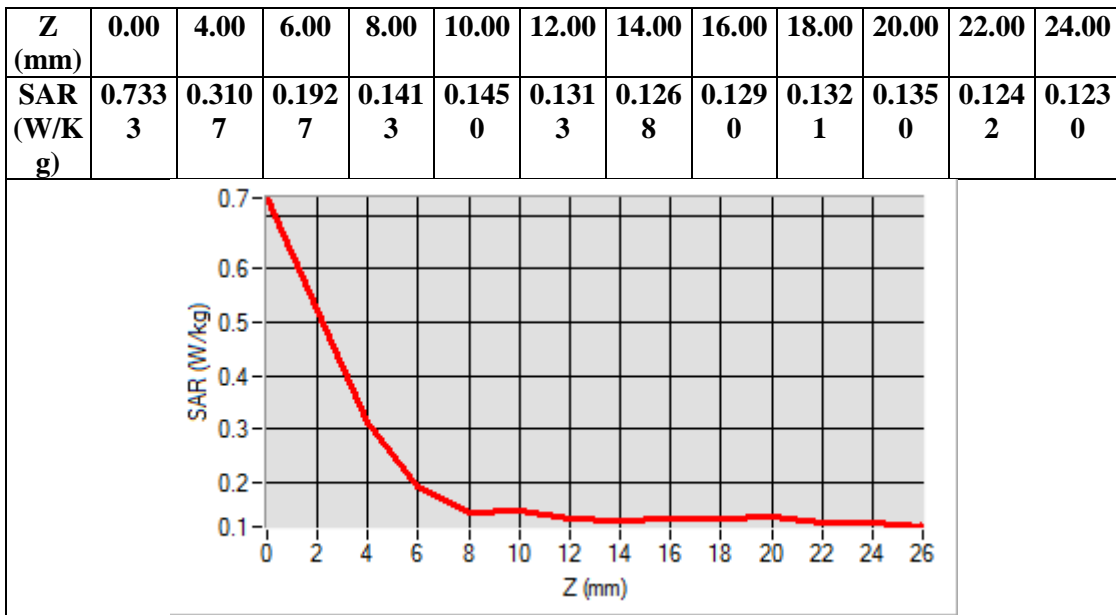

Any report having not been signed by authorized approver, or having been altered without authorization, or having not been stamped by the “Dedicated Testing/Inspection Stamp” is deemed to be invalid. Copying or excerpting portion of, or altering the content of the report is not permitted without the written authorization of AGC. The test results presented in the report apply only to the tested sample. Any objections to report issued by AGC should be submitted to AGC within 15days after the issuance of the test report. Further enquiry of validity or verification of the test report should be addressed to AGC by agc01@agccert.com.

**Repeated SAR**

**Test Laboratory: AGC Lab**  
**WCDMA Band II Low-Edge 3(Bottom)(RMC)**  
**DUT: Body Worn Camera ; Type: K7**

**Date: Dec. 01, 2023**

Communication System: UMTS; Communication System Band: Band II UTRA/FDD ;Duty Cycle:1:1; Conv.F=2.15  
Frequency: 1852.4 MHz; Medium parameters used:  $f = 1900$  MHz;  $\sigma=1.35$  mho/m;  $\epsilon_r = 42.03$ ;  $\rho = 1000$  kg/m<sup>3</sup> ;  
Phantom section: Flat Section  
Ambient temperature (°C): 20.7, Liquid temperature (°C): 20.3

**SATIMO Configuration:**

Probe: SSE2; Calibrated: May 31, 2023; Serial No.: 2023-EPGO-414  
Sensor-Surface: 4mm (Mechanical Surface Detection)  
Phantom: SAM twin phantom  
Measurement SW: OpenSAR V4\_02\_32

**Configuration/ WCDMA band II Low-Edge 3(Bottom)/Area Scan:** Measurement grid: dx=8mm, dy=8mm  
**Configuration/ WCDMA band II Low-Edge 3(Bottom)/Zoom Scan:** Measurement grid: dx=8mm,dy=8mm, dz=5mm;

<b>Area Scan</b>	surf_sam_plan.txt, h= 5.00 mm
<b>Zoom Scan</b>	5x5x7,dx=8mm dy=8mm dz=5mm,Complete
<b>Phantom</b>	Validation plane
<b>Device Position</b>	Edge 3(Bottom)
<b>Band</b>	WCDMA band II
<b>Channels</b>	Low
<b>Signal</b>	CDMA (Crest factor: 1.0)

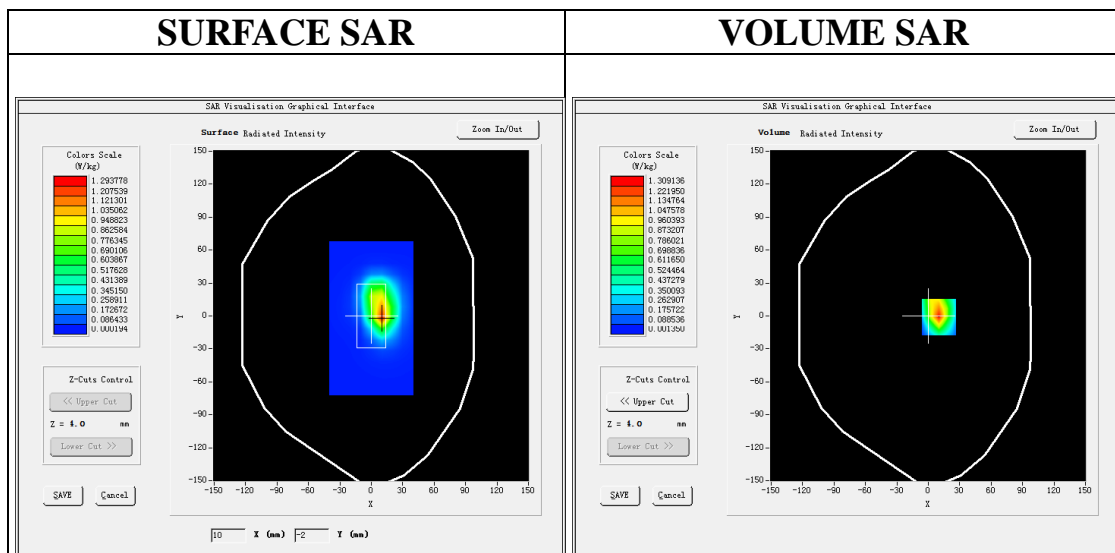

**Maximum location: X=10.00, Y=-1.00**  
**SAR Peak: 2.53 W/kg**

<b>SAR 10g (W/Kg)</b>	0.491526
<b>SAR 1g (W/Kg)</b>	1.215261

Any report having not been signed by authorized approver, or having been altered without authorization, or having not been stamped by the “Dedicated Testing/Inspection Stamp” is deemed to be invalid. Copying or excerpting portion of, or altering the content of the report is not permitted without the written authorization of AGC. The test results presented in the report apply only to the tested sample. Any objections to report issued by AGC should be submitted to AGC within 15days after the issuance of the test report. Further enquiry of validity or verification of the test report should be addressed to AGC by agc01@agccert.com.

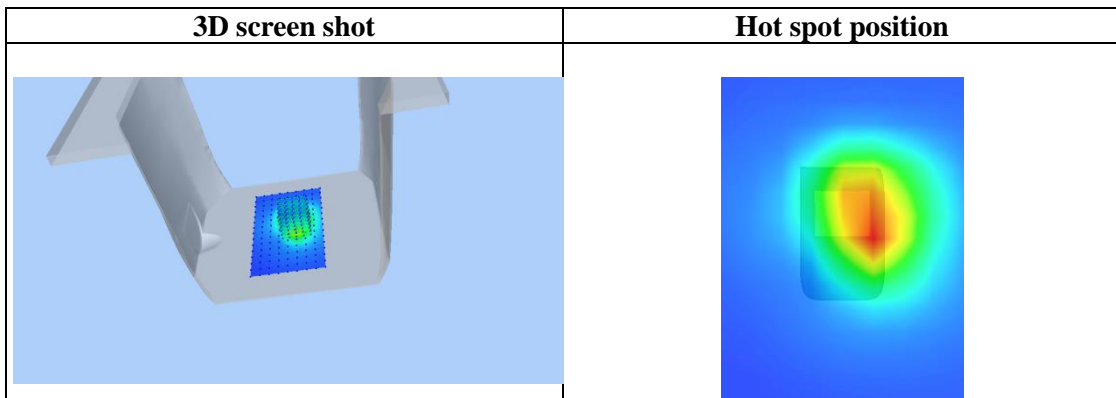
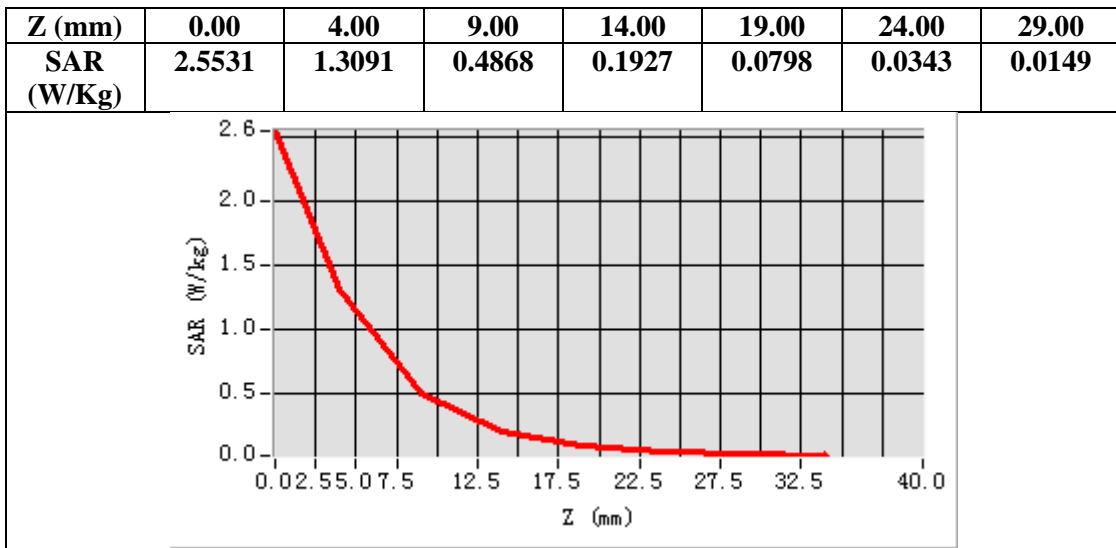

Any report having not been signed by authorized approver, or having been altered without authorization, or having not been stamped by the “Dedicated Testing/Inspection Stamp” is deemed to be invalid. Copying or excerpting portion of, or altering the content of the report is not permitted without the written authorization of AGC. The test results presented in the report apply only to the tested sample. Any objections to report issued by AGC should be submitted to AGC within 15days after the issuance of the test report. Further enquiry of validity or verification of the test report should be addressed to AGC by agc01@agccert.com.

**Test Laboratory: AGC Lab**  
**WCDMA Band IV High- Edge 3(Bottom) (RMC)**  
**DUT: Body Worn Camera ; Type: K7**

**Date: Dec. 20, 2023**

Communication System: UMTS; Communication System Band: BAND IV UTRA/FDD; Duty Cycle:1: 1; Conv.F=2.17;  
Frequency:1752.6 MHz; Medium parameters used:  $f = 1750$  MHz;  $\sigma = 1.42$  mho/m;  $\epsilon_r = 38.92$ ;  $\rho = 1000$  kg/m<sup>3</sup>;  
Phantom section: Flat Section  
Ambient temperature (°C): 21.7, Liquid temperature (°C): 21.2

**SATIMO Configuration:**

Probe: SSE2; Calibrated: May 31, 2023; Serial No.: 2023-EPGO-414  
Sensor-Surface: 4mm (Mechanical Surface Detection)  
Phantom: SAM twin phantom  
Measurement SW: OpenSAR V4\_02\_32

**Configuration/ WCDMA Band IV High- Edge 3(Bottom)/Area Scan:** Measurement grid: dx=8mm, dy=8mm  
**Configuration/ WCDMA Band IV High- Edge 3(Bottom)/Zoom Scan:** Measurement grid: dx=8mm,dy=8mm, dz=5mm;

<b>Area Scan</b>	surf_sam_plan.txt, h= 5.00 mm
<b>ZoomScan</b>	5x5x7,dx=8mm dy=8mm dz=5mm,Complete
<b>Phantom</b>	Validation plane
<b>Device Position</b>	Edge 3(Bottom)
<b>Band</b>	WCDMA Band IV
<b>Channels</b>	High
<b>Signal</b>	CDMA (Crest factor: 1.0)

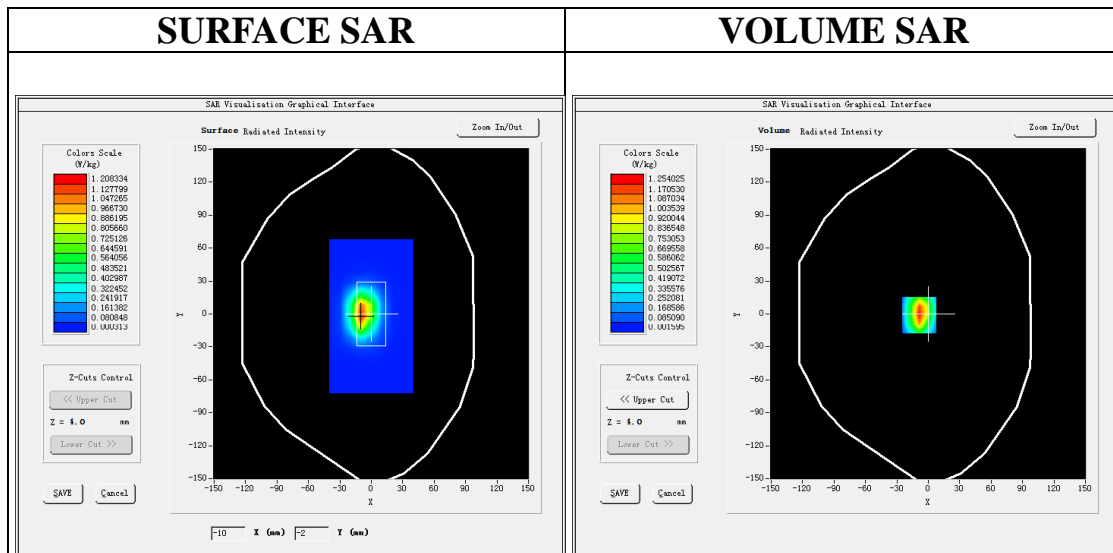

**Maximum location: X=-9.00, Y=-1.00**

**SAR Peak: 2.10 W/kg**

<b>SAR 10g (W/Kg)</b>	0.523144
<b>SAR 1g (W/Kg)</b>	1.150966

Any report having not been signed by authorized approver, or having been altered without authorization, or having not been stamped by the "Dedicated Testing/Inspection Stamp" is deemed to be invalid. Copying or excerpting portion of, or altering the content of the report is not permitted without the written authorization of AGC. The test results presented in the report apply only to the tested sample. Any objections to report issued by AGC should be submitted to AGC within 15days after the issuance of the test report. Further enquiry of validity or verification of the test report should be addressed to AGC by agc01@agccert.com.

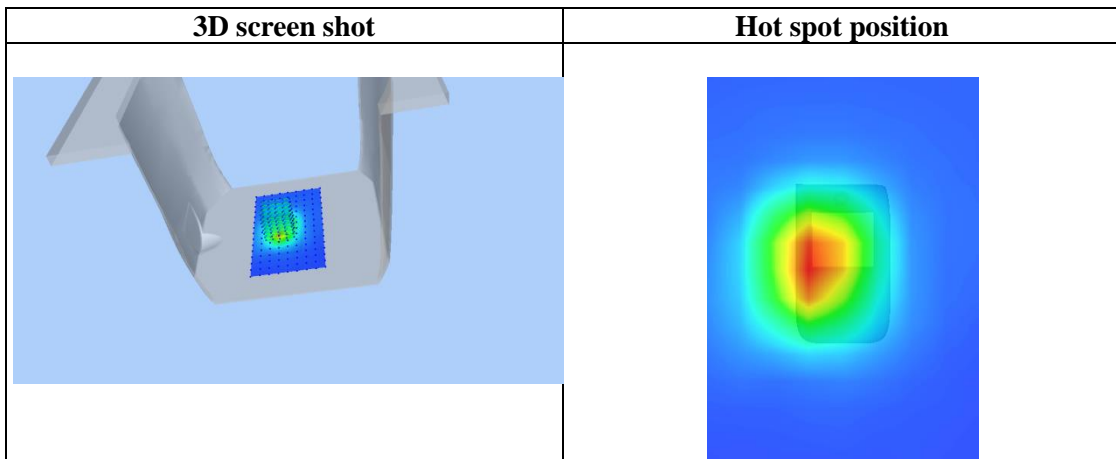
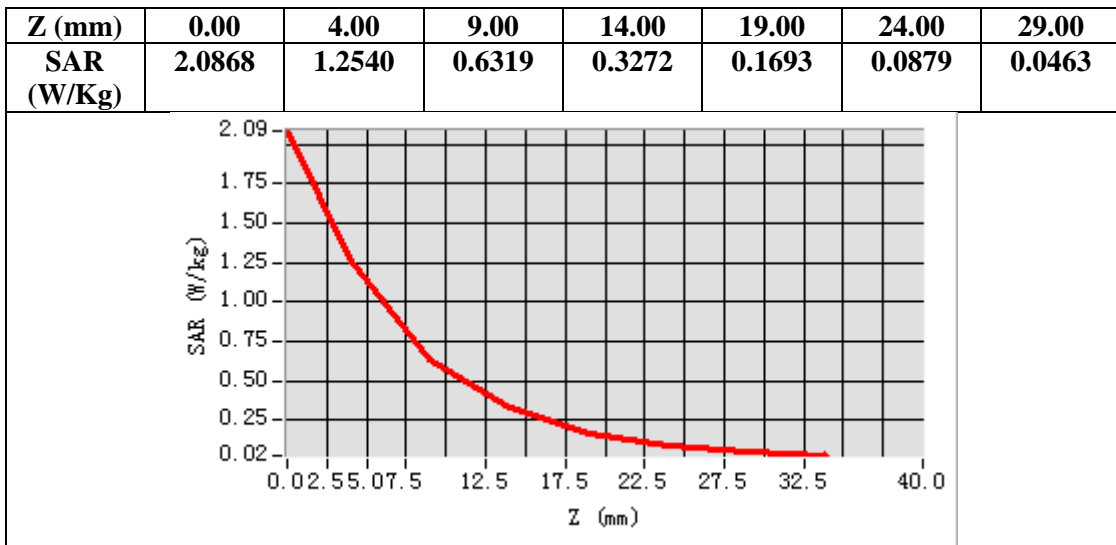

Any report having not been signed by authorized approver, or having been altered without authorization, or having not been stamped by the “Dedicated Testing/Inspection Stamp” is deemed to be invalid. Copying or excerpting portion of, or altering the content of the report is not permitted without the written authorization of AGC. The test results presented in the report apply only to the tested sample. Any objections to report issued by AGC should be submitted to AGC within 15days after the issuance of the test report. Further enquiry of validity or verification of the test report should be addressed to AGC by agc01@agccert.com.

Test Laboratory: AGC Lab

Date: Dec. 05, 2023

WCDMA Band V High- Edge 3(Bottom) (RMC)

DUT: Body Worn Camera ; Type: K7

Communication System: UMTS; Communication System Band: BAND V UTRA/FDD; Duty Cycle:1: 1; Conv.F=2.02; Frequency: 846.6 MHz; Medium parameters used:  $f = 835\text{MHz}$ ;  $\sigma = 0.94 \text{ mho/m}$ ;  $\epsilon_r = 39.67$ ;  $\rho = 1000 \text{ kg/m}^3$  ; Phantom section: Flat Section  
Ambient temperature (°C): 22.4, Liquid temperature (°C): 21.7

SATIMO Configuration:

Probe: SSE2; Calibrated: May 31, 2023; Serial No.: 2023-EPGO-414

Sensor-Surface: 4mm (Mechanical Surface Detection)

Phantom: SAM twin phantom

Measurement SW: OpenSAR V4\_02\_32

**Configuration/ WCDMA Band V High- Edge 3(Bottom)/Area Scan:** Measurement grid: dx=8mm, dy=8mm  
**Configuration/ WCDMA Band V High- Edge 3(Bottom)/Zoom Scan:** Measurement grid: dx=8mm,dy=8mm, dz=5mm;

<b>Area Scan</b>	surf_sam_plan.txt, h= 5.00 mm
<b>ZoomScan</b>	5x5x7,dx=8mm dy=8mm dz=5mm,Complete
<b>Phantom</b>	Validation plane
<b>Device Position</b>	Edge 3(Bottom)
<b>Band</b>	WCDMA Band V
<b>Channels</b>	High
<b>Signal</b>	CDMA (Crest factor: 1.0)

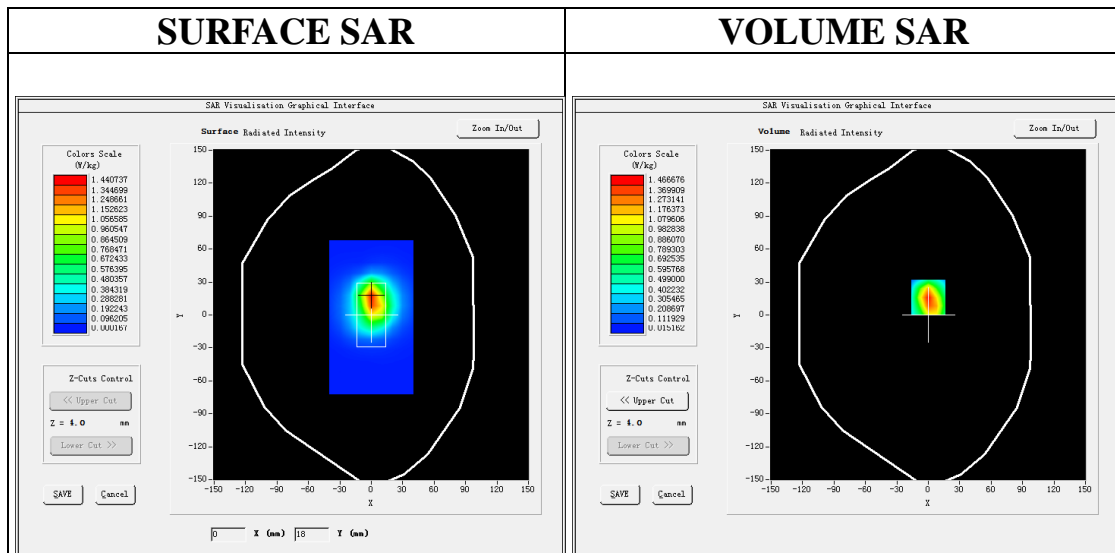

**Maximum location: X=0.00, Y=16.00**

**SAR Peak: 2.55 W/kg**

<b>SAR 10g (W/Kg)</b>	0.674467
<b>SAR 1g (W/Kg)</b>	1.382543

Any report having not been signed by authorized approver, or having been altered without authorization, or having not been stamped by the "Dedicated Testing/Inspection Stamp" is deemed to be invalid. Copying or excerpting portion of, or altering the content of the report is not permitted without the written authorization of AGC. The test results presented in the report apply only to the tested sample. Any objections to report issued by AGC should be submitted to AGC within 15days after the issuance of the test report. Further enquiry of validity or verification of the test report should be addressed to AGC by agc01@agccert.com.

Attestation of Global Compliance(Shenzhen)Co., Ltd

Attestation of Global Compliance(Shenzhen)Std & Tech Co., Ltd

Tel: +86-755 2523 4088 E-mail: agc@agccert.com Web: http://www.agccert.com/

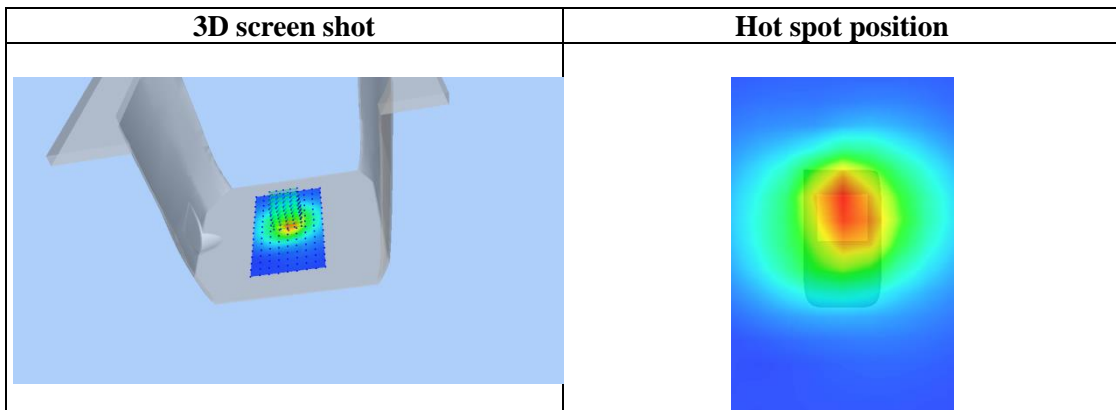
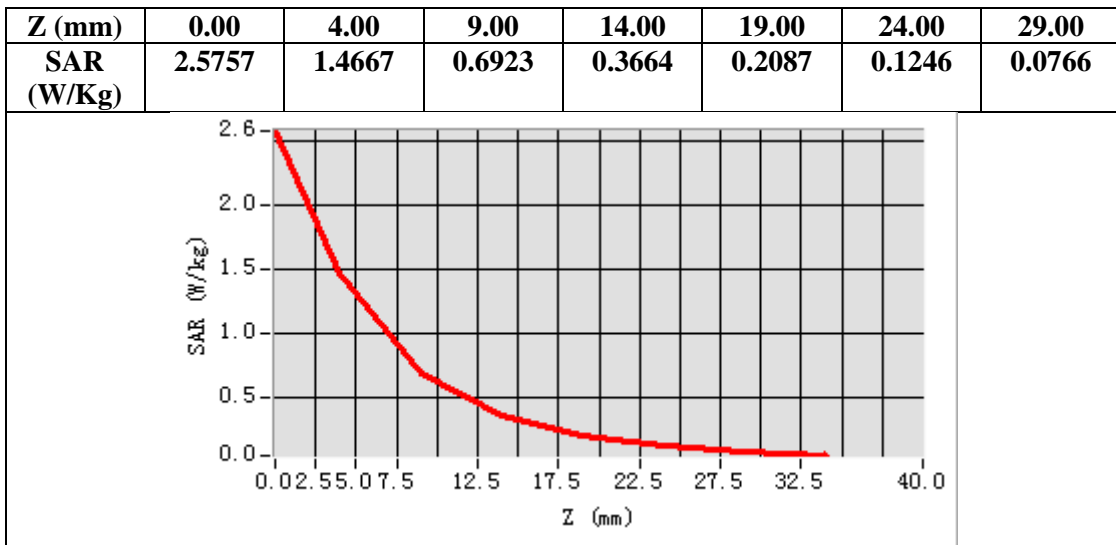

Any report having not been signed by authorized approver, or having been altered without authorization, or having not been stamped by the “Dedicated Testing/Inspection Stamp” is deemed to be invalid. Copying or excerpting portion of, or altering the content of the report is not permitted without the written authorization of AGC. The test results presented in the report apply only to the tested sample. Any objections to report issued by AGC should be submitted to AGC within 15days after the issuance of the test report. Further enquiry of validity or verification of the test report should be addressed to AGC by agc01@agccert.com.



**Test Laboratory: AGC Lab**  
**LTE Band 2 Mid-Edge 3(Bottom) (1 RB#0)**  
**DUT: Body Worn Camera ; Type: K7**

**Date: Dec. 01, 2023**

Communication System: LTE; Communication System Band: LTE Band 2; Duty Cycle:1:1; Conv.F=2.15;  
Frequency:1880MHz; Medium parameters used:  $f = 1900$  MHz;  $\sigma = 1.40$  mho/m;  $\epsilon_r = 40.36$ ;  $\rho = 1000$  kg/m<sup>3</sup> ;  
Phantom section: Flat Section  
Ambient temperature (°C): 20.7, Liquid temperature (°C): 20.3

**SATIMO Configuration:**

Probe: SSE2; Calibrated: May 31, 2023; Serial No.: 2023-EPGO-414  
Sensor-Surface: 4mm (Mechanical Surface Detection)  
Phantom: SAM twin phantom  
Measurement SW: OpenSAR V4\_02\_32

**Configuration/ LTE Band 2 Mid-Edge 3(Bottom)/Area Scan:** Measurement grid: dx=8mm, dy=8mm  
**Configuration/ LTE Band 2 Mid-Edge 3(Bottom)/Zoom Scan:** Measurement grid: dx=8mm,dy=8mm, dz=5mm;

<b>Area Scan</b>	surf_sam_plan.txt, h= 5.00 mm
<b>Zoom Scan</b>	5x5x7,dx=8mm dy=8mm dz=5mm
<b>Phantom</b>	Validation plane
<b>Device Position</b>	Edge 3(Bottom)
<b>Band</b>	LTE Band 2
<b>Channels</b>	Middle
<b>Signal</b>	OFDM (Crest factor: 1.0)

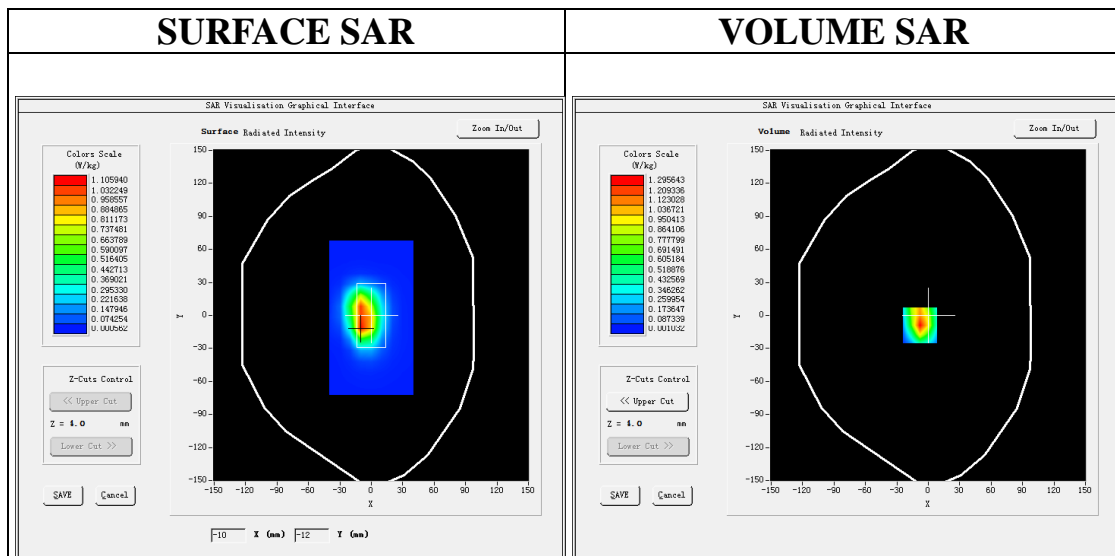

**Maximum location: X=-8.00, Y=-9.00**  
**SAR Peak: 2.57 W/kg**

<b>SAR 10g (W/Kg)</b>	0.496991
<b>SAR 1g (W/Kg)</b>	1.219304

Any report having not been signed by authorized approver, or having been altered without authorization, or having not been stamped by the “Dedicated Testing/Inspection Stamp” is deemed to be invalid. Copying or excerpting portion of, or altering the content of the report is not permitted without the written authorization of AGC. The test results presented in the report apply only to the tested sample. Any objections to report issued by AGC should be submitted to AGC within 15days after the issuance of the test report. Further enquiry of validity or verification of the test report should be addressed to AGC by agc01@agccert.com.

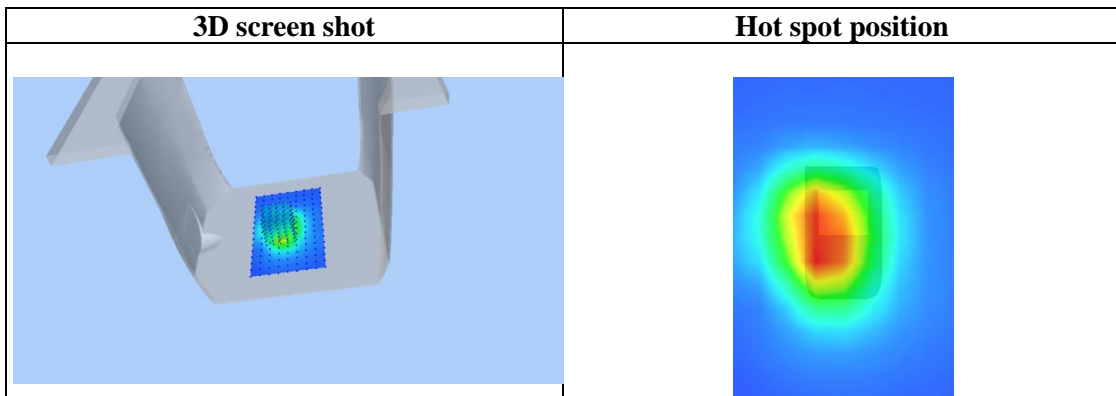
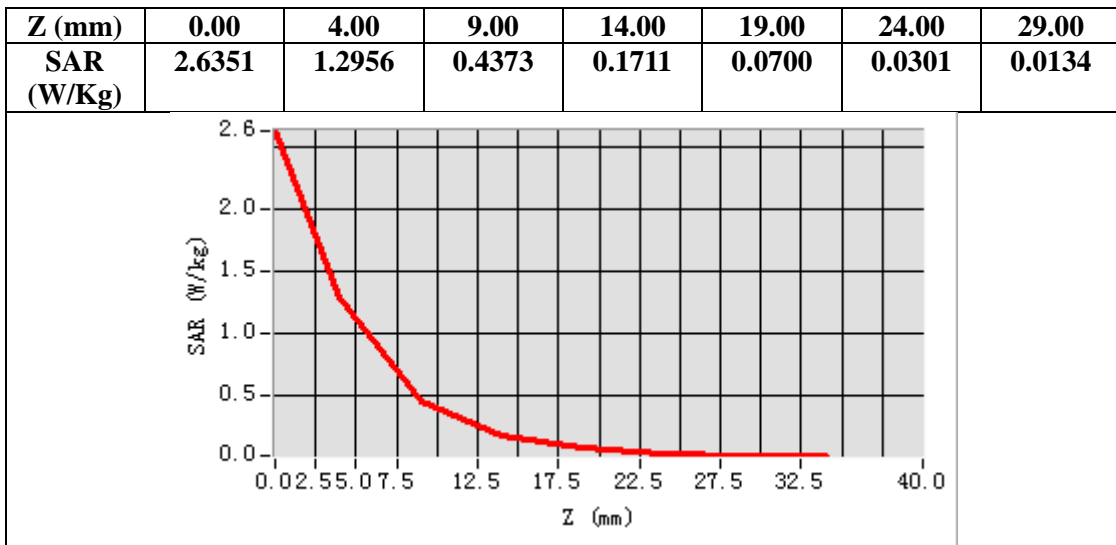

Any report having not been signed by authorized approver, or having been altered without authorization, or having not been stamped by the “Dedicated Testing/Inspection Stamp” is deemed to be invalid. Copying or excerpting portion of, or altering the content of the report is not permitted without the written authorization of AGC. The test results presented in the report apply only to the tested sample. Any objections to report issued by AGC should be submitted to AGC within 15days after the issuance of the test report. Further enquiry of validity or verification of the test report should be addressed to AGC by agc01@agccert.com.

**Test Laboratory: AGC Lab**  
**LTE Band 4 Mid-Edge 3(Bottom) (1 RB#0)**  
**DUT: Body Worn Camera ; Type: K7**

**Date: Dec. 20, 2023**

Communication System: LTE; Communication System Band: LTE Band 4; Duty Cycle:1:1; Conv.F=2.17;  
Frequency:1732.5 MHz; Medium parameters used:  $f = 1750$  MHz;  $\sigma = 1.36$  mho/m;  $\epsilon_r = 40.92$ ;  $\rho = 1000$  kg/m<sup>3</sup> ;  
Phantom section: Flat Section  
Ambient temperature (°C): 21.7, Liquid temperature (°C): 21.2

**SATIMO Configuration:**

Probe: SSE2; Calibrated: May 31, 2023; Serial No.: 2023-EPGO-414  
Sensor-Surface: 4mm (Mechanical Surface Detection)  
Phantom: SAM twin phantom  
Measurement SW: OpenSAR V4\_02\_32

**Configuration/ LTE Band 4 Mid-Edge 3(Bottom)/Area Scan:** Measurement grid: dx=8mm, dy=8mm  
**Configuration/ LTE Band 4 Mid-Edge 3(Bottom)/Zoom Scan:** Measurement grid: dx=8mm,dy=8mm, dz=5mm;

<b>Area Scan</b>	surf_sam_plan.txt, h= 5.00 mm
<b>Zoom Scan</b>	5x5x7,dx=8mm dy=8mm dz=5mm
<b>Phantom</b>	Validation plane
<b>Device Position</b>	Edge 3(Bottom)
<b>Band</b>	LTE Band 4
<b>Channels</b>	Middle
<b>Signal</b>	OFDM (Crest factor: 1.0)

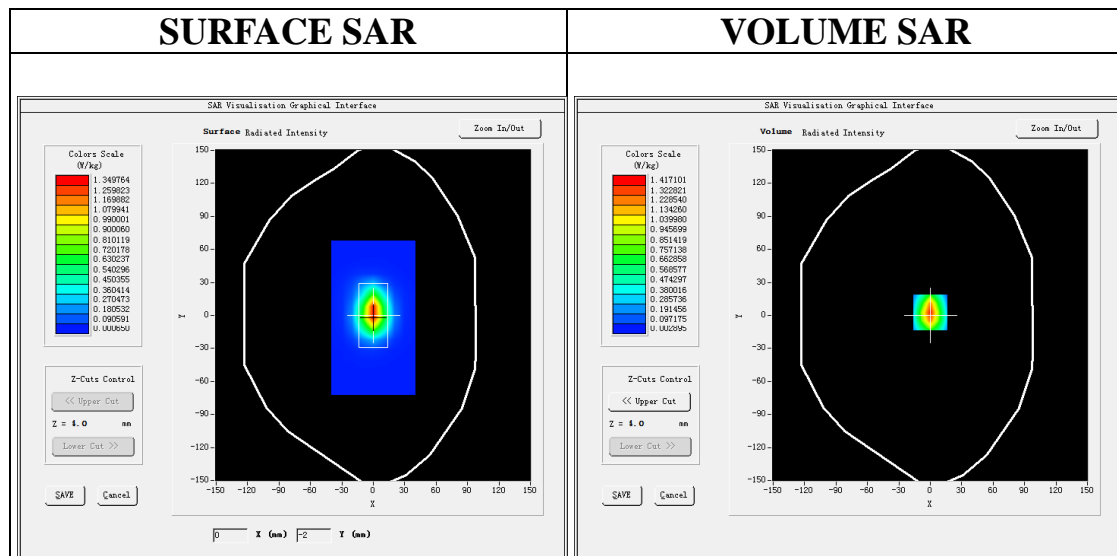

**Maximum location: X=0.00, Y=3.00**

**SAR Peak: 2.35 W/kg**

<b>SAR 10g (W/Kg)</b>	0.594522
<b>SAR 1g (W/Kg)</b>	1.287461

Any report having not been signed by authorized approver, or having been altered without authorization, or having not been stamped by the “Dedicated Testing/Inspection Stamp” is deemed to be invalid. Copying or excerpting portion of, or altering the content of the report is not permitted without the written authorization of AGC. The test results presented in the report apply only to the tested sample. Any objections to report issued by AGC should be submitted to AGC within 15days after the issuance of the test report. Further enquiry of validity or verification of the test report should be addressed to AGC by agc01@agccert.com.

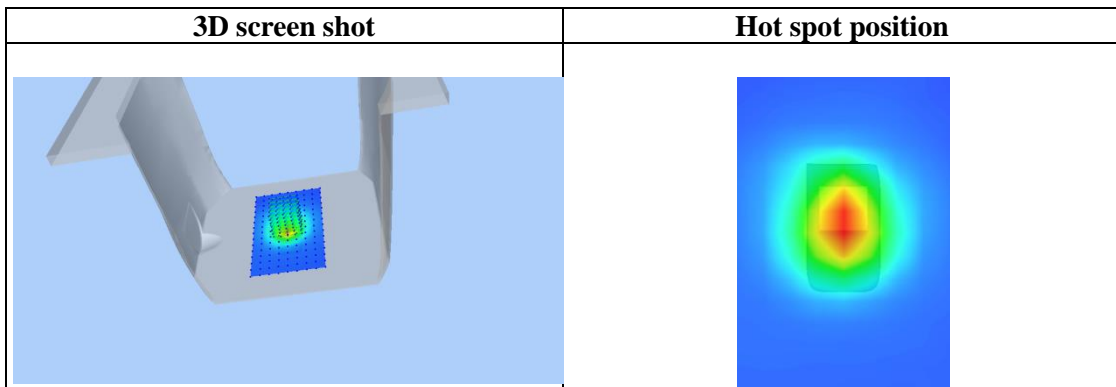
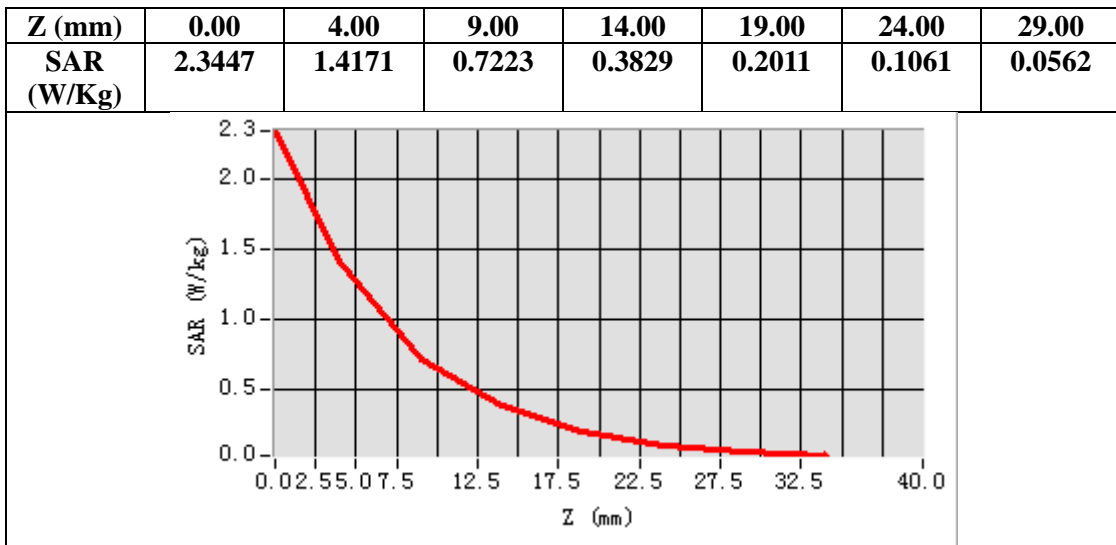

Any report having not been signed by authorized approver, or having been altered without authorization, or having not been stamped by the "Dedicated Testing/Inspection Stamp" is deemed to be invalid. Copying or excerpting portion of, or altering the content of the report is not permitted without the written authorization of AGC. The test results presented in the report apply only to the tested sample. Any objections to report issued by AGC should be submitted to AGC within 15days after the issuance of the test report. Further enquiry of validity or verification of the test report should be addressed to AGC by agc01@agccert.com.

**Test Laboratory: AGC Lab**  
**LTE Band 5 High-Edge 3(Bottom) (1 RB#0)**  
**DUT: Body Worn Camera ; Type: K7**

**Date: Dec. 05, 2023**

Communication System: LTE; Communication System Band: LTE Band 5; Duty Cycle:1:1; Conv.F=2.02  
Frequency: 844 MHz; Medium parameters used:  $f = 835 \text{ MHz}$ ;  $\sigma=0.95\text{mho/m}$ ;  $\epsilon_r=39.10$ ;  $\rho= 1000 \text{ kg/m}^3$  ;  
Phantom section: Flat Section  
Ambient temperature ( $^{\circ}\text{C}$ ): 22.4, Liquid temperature ( $^{\circ}\text{C}$ ): 21.7

**SATIMO Configuration:**

Probe: SSE2; Calibrated: May 31, 2023; Serial No.: 2023-EPGO-414  
Sensor-Surface: 4mm (Mechanical Surface Detection)  
Phantom: SAM twin phantom  
Measurement SW: OpenSAR V4\_02\_32

**Configuration/ LTE Band 5 High-Edge 3(Bottom)/Area Scan:** Measurement grid:  $dx=8\text{mm}$ ,  $dy=8\text{mm}$   
**Configuration/ LTE Band 5 High-Edge 3(Bottom)/Zoom Scan:** Measurement grid:  $dx=8\text{mm}$ ,  $dy=8\text{mm}$ ,  $dz=5\text{mm}$ ;

<b>Area Scan</b>	surf_sam_plan.txt, h= 5.00 mm
<b>Zoom Scan</b>	5x5x7,dx=8mm dy=8mm dz=5mm
<b>Phantom</b>	Validation plane
<b>Device Position</b>	Edge 3(Bottom)
<b>Band</b>	LTE Band 5
<b>Channels</b>	High
<b>Signal</b>	OFDM (Crest factor: 1.0)

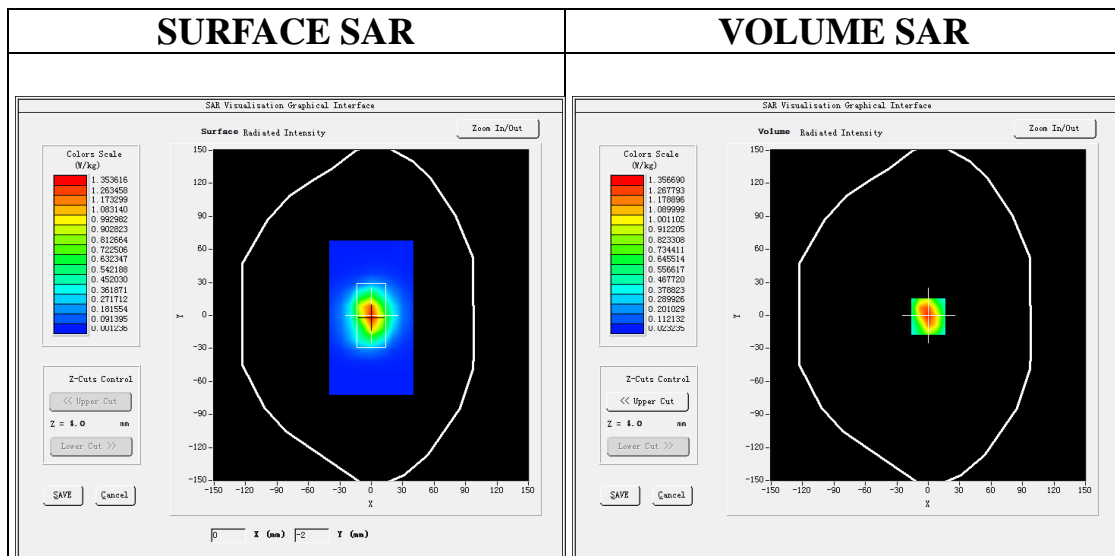

**Maximum location: X=0.00, Y=-1.00**

**SAR Peak: 2.32 W/kg**

<b>SAR 10g (W/Kg)</b>	0.652501
<b>SAR 1g (W/Kg)</b>	1.295878

Any report having not been signed by authorized approver, or having been altered without authorization, or having not been stamped by the “Dedicated Testing/Inspection Stamp” is deemed to be invalid. Copying or excerpting portion of, or altering the content of the report is not permitted without the written authorization of AGC. The test results presented in the report apply only to the tested sample. Any objections to report issued by AGC should be submitted to AGC within 15days after the issuance of the test report. Further enquiry of validity or verification of the test report should be addressed to AGC by agc01@agccert.com.

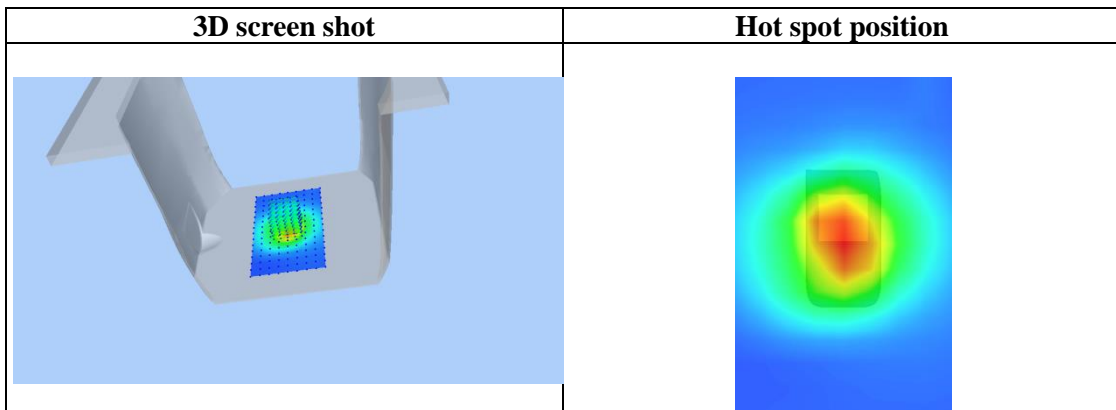
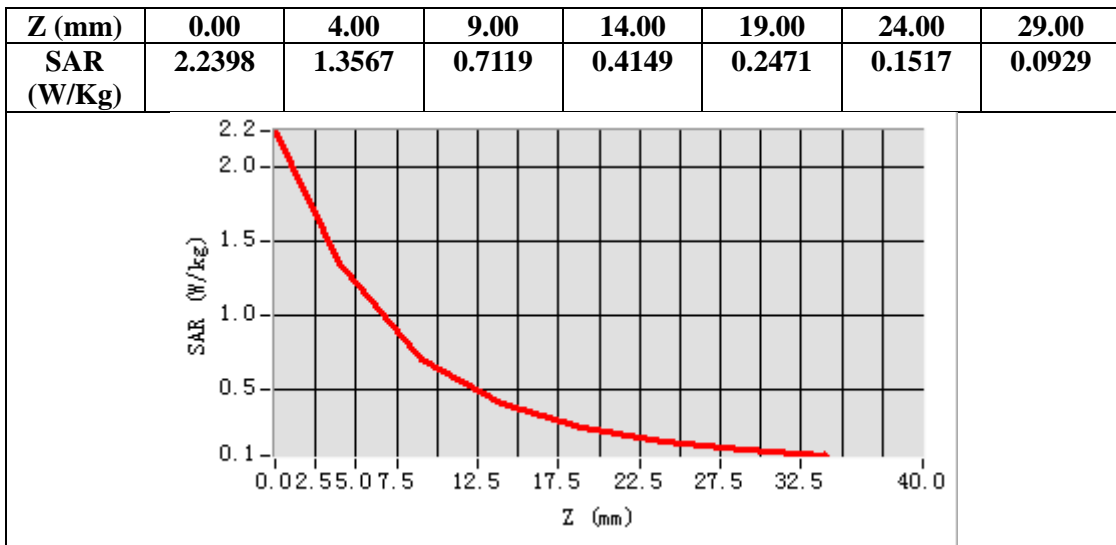

Any report having not been signed by authorized approver, or having been altered without authorization, or having not been stamped by the “Dedicated Testing/Inspection Stamp” is deemed to be invalid. Copying or excerpting portion of, or altering the content of the report is not permitted without the written authorization of AGC. The test results presented in the report apply only to the tested sample. Any objections to report issued by AGC should be submitted to AGC within 15days after the issuance of the test report. Further enquiry of validity or verification of the test report should be addressed to AGC by agc01@agccert.com.

**Test Laboratory: AGC Lab**  
**LTE Band 12 Low-Edge 3(Bottom) (1 RB#0)**  
**DUT: Body Worn Camera ; Type: K7**

**Date: Dec. 09, 2023**

Communication System: LTE; Communication System Band: LTE Band 12; Duty Cycle:1:1; Conv.F=1.95;  
Frequency: 704 MHz; Medium parameters used:  $f = 750$  MHz;  $\sigma=0.82$  mho/m;  $\epsilon_r = 41.68$ ;  $\rho= 1000$  kg/m<sup>3</sup> ;  
Phantom section: Flat Section  
Ambient temperature (°C): 20.8, Liquid temperature (°C): 20.5

**SATIMO Configuration:**

Probe: SSE2; Calibrated: May 31, 2023; Serial No.: 2023-EPGO-414  
Sensor-Surface: 4mm (Mechanical Surface Detection)  
Phantom: SAM twin phantom  
Measurement SW: OpenSAR V4\_02\_32

**Configuration/ LTE Band 12 Low-Edge 3(Bottom)/Area Scan:** Measurement grid: dx=8mm, dy=8mm  
**Configuration/ LTE Band 12 Low-Edge 3(Bottom)/Zoom Scan:** Measurement grid: dx=8mm,dy=8mm, dz=5m;

<b>Area Scan</b>	surf_sam_plan.txt, h= 5.00 mm
<b>Zoom Scan</b>	5x5x7,dx=8mm dy=8mm dz=5mm
<b>Phantom</b>	Validation plane
<b>Device Position</b>	Edge 3(Bottom)
<b>Band</b>	LTE Band 12
<b>Channels</b>	Low
<b>Signal</b>	OFDM (Crest factor: 1.0)

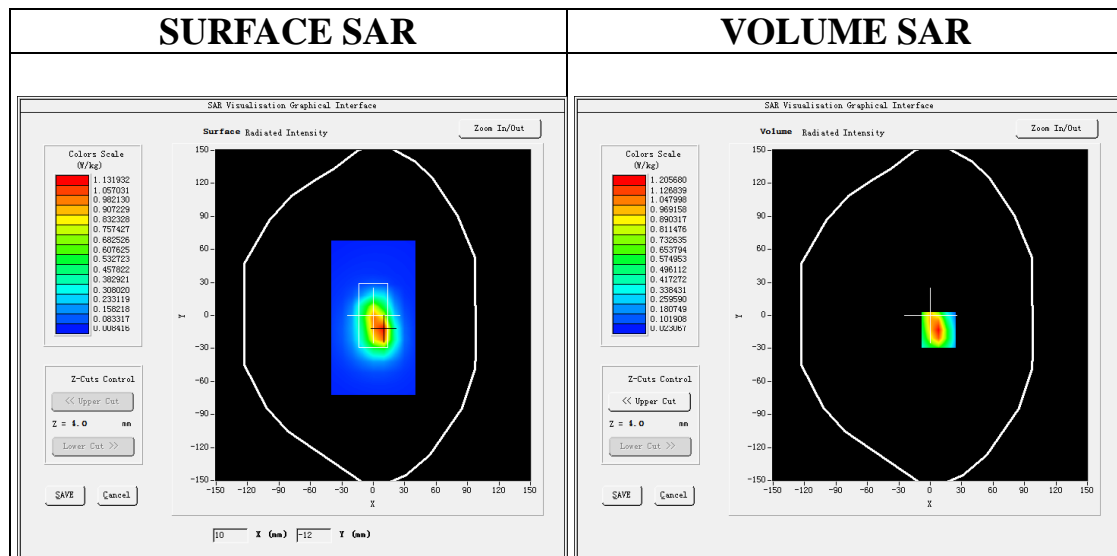

**Maximum location: X=8.00, Y=-13.00**

**SAR Peak: 2.11 W/kg**

<b>SAR 10g (W/Kg)</b>	0.579171
<b>SAR 1g (W/Kg)</b>	1.166969

Any report having not been signed by authorized approver, or having been altered without authorization, or having not been stamped by the “Dedicated Testing/Inspection Stamp” is deemed to be invalid. Copying or excerpting portion of, or altering the content of the report is not permitted without the written authorization of AGC. The test results presented in the report apply only to the tested sample. Any objections to report issued by AGC should be submitted to AGC within 15days after the issuance of the test report. Further enquiry of validity or verification of the test report should be addressed to AGC by agc01@agccert.com.

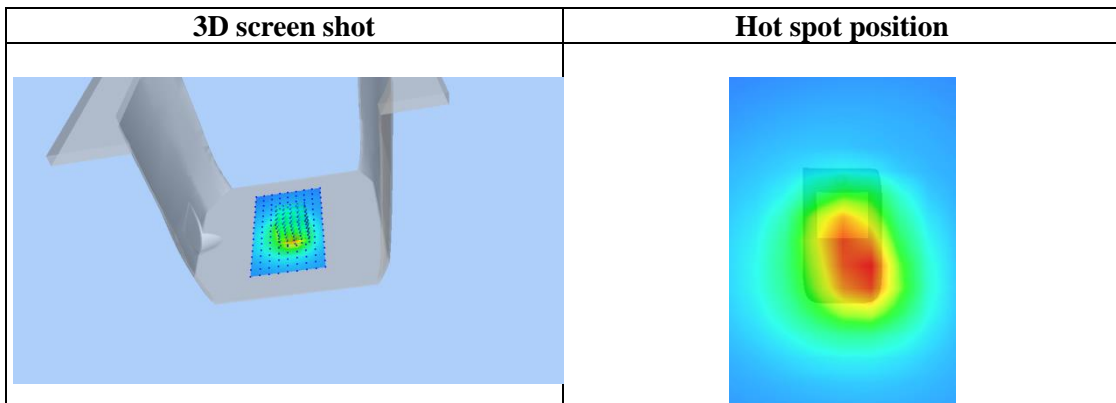
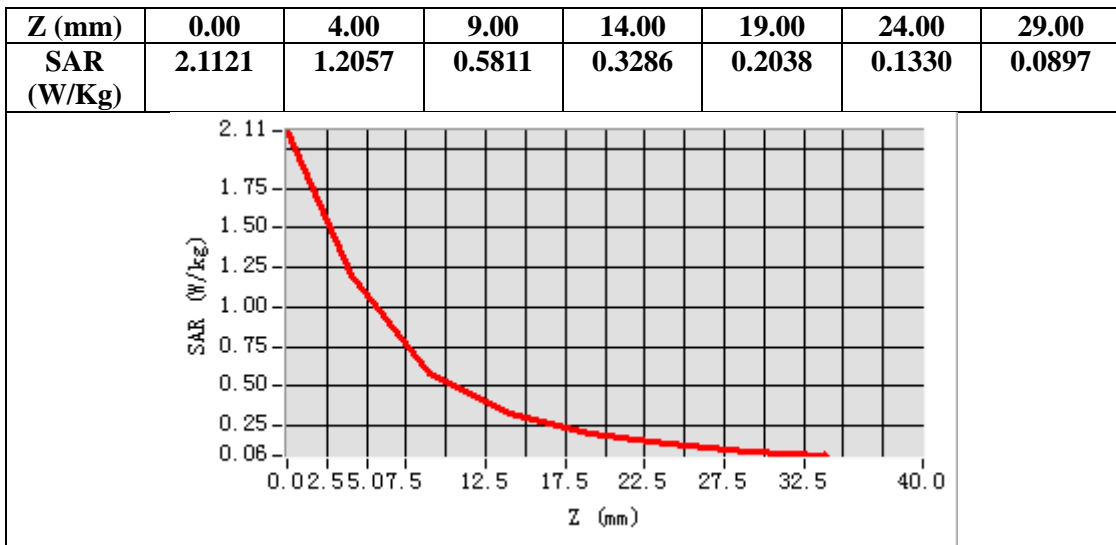

Any report having not been signed by authorized approver, or having been altered without authorization, or having not been stamped by the “Dedicated Testing/Inspection Stamp” is deemed to be invalid. Copying or excerpting portion of, or altering the content of the report is not permitted without the written authorization of AGC. The test results presented in the report apply only to the tested sample. Any objections to report issued by AGC should be submitted to AGC within 15days after the issuance of the test report. Further enquiry of validity or verification of the test report should be addressed to AGC by agc01@agccert.com.



Test Laboratory: AGC Lab  
LTE Band 13 Mid-Edge 3(Bottom) (1 RB#0)  
DUT: Body Worn Camera ; Type: K7

Date: Dec. 09, 2023

Communication System: LTE; Communication System Band: LTE Band 13; Duty Cycle:1:1; Conv.F=1.95;  
Frequency: 782 MHz; Medium parameters used:  $f = 750$  MHz;  $\sigma=0.89$  mho/m;  $\epsilon_r = 39.61$ ;  $\rho= 1000$  kg/m<sup>3</sup> ;  
Phantom section: Flat Section  
Ambient temperature (°C): 20.8, Liquid temperature (°C): 20.5

SATIMO Configuration:

Probe: SSE2; Calibrated: May 31, 2023; Serial No.: 2023-EPGO-414  
Sensor-Surface: 4mm (Mechanical Surface Detection)  
Phantom: SAM twin phantom  
Measurement SW: OpenSAR V4\_02\_32

Configuration/ LTE Band 13 Mid-Edge 3(Bottom)/Area Scan: Measurement grid: dx=8mm, dy=8mm  
Configuration/ LTE Band 13 Mid-Edge 3(Bottom)/Zoom Scan: Measurement grid: dx=8mm,dy=8mm, dz=5m;

Area Scan	surf_sam_plan.txt, h= 5.00 mm
Zoom Scan	5x5x7,dx=8mm dy=8mm dz=5mm
Phantom	Validation plane
Device Position	Edge 3(Bottom)
Band	LTE Band 13
Channels	Middle
Signal	OFDM (Crest factor: 1.0)

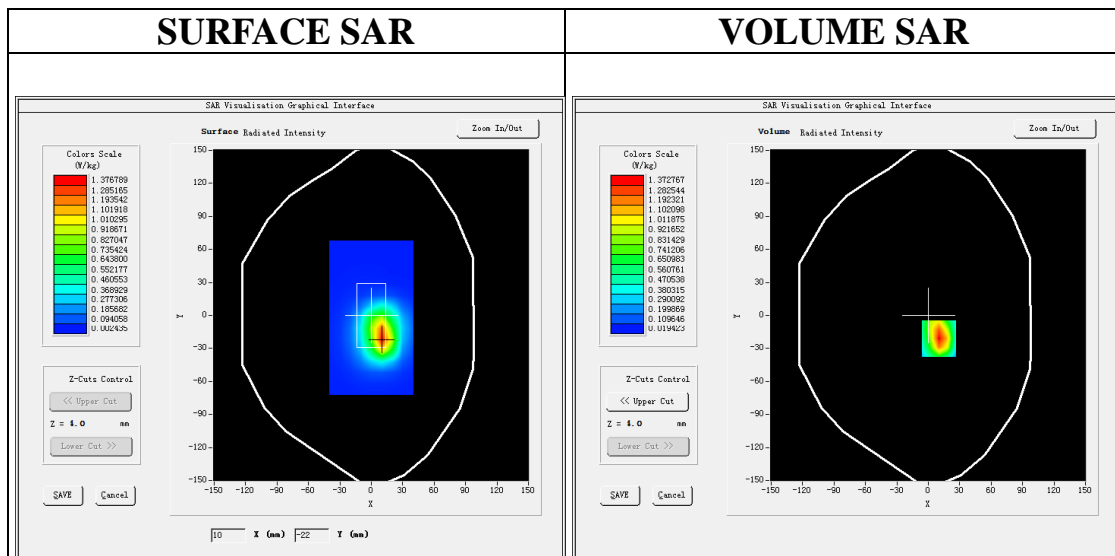

Maximum location: X=10.00, Y=-21.00

SAR Peak: 2.39 W/kg

SAR 10g (W/Kg)	0.643538
SAR 1g (W/Kg)	1.311588

Any report having not been signed by authorized approver, or having been altered without authorization, or having not been stamped by the "Dedicated Testing/Inspection Stamp" is deemed to be invalid. Copying or excerpting portion of, or altering the content of the report is not permitted without the written authorization of AGC. The test results presented in the report apply only to the tested sample. Any objections to report issued by AGC should be submitted to AGC within 15days after the issuance of the test report. Further enquiry of validity or verification of the test report should be addressed to AGC by agc01@agccert.com.

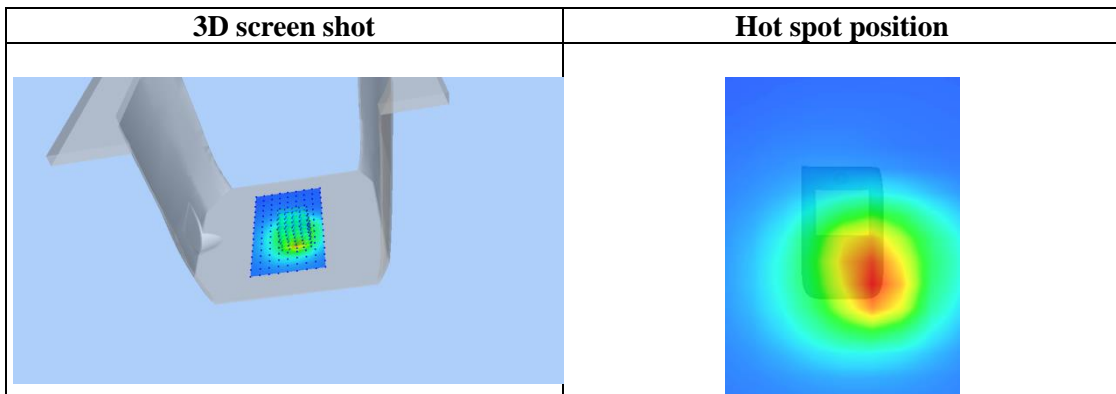
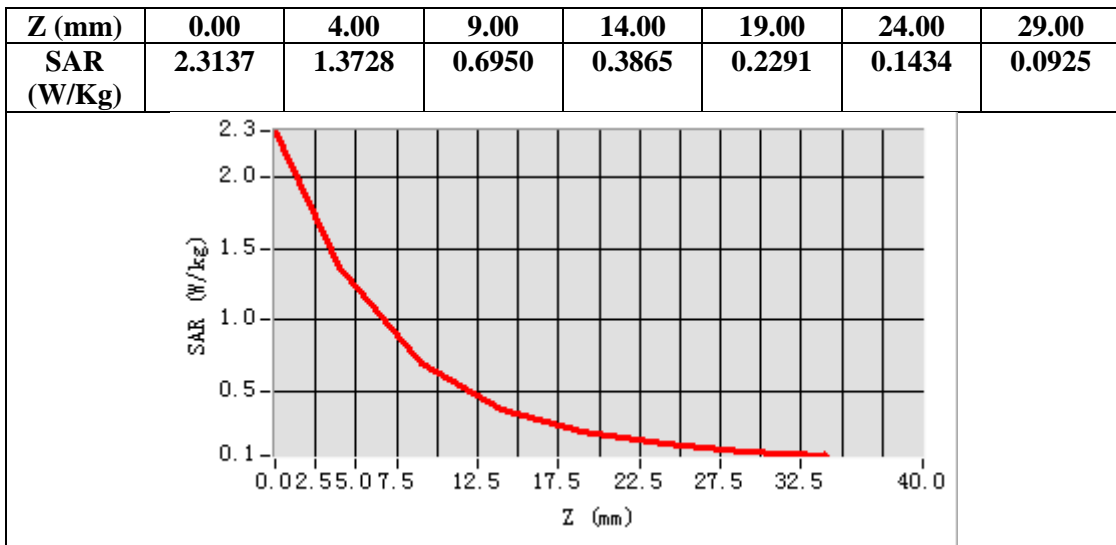

Any report having not been signed by authorized approver, or having been altered without authorization, or having not been stamped by the “Dedicated Testing/Inspection Stamp” is deemed to be invalid. Copying or excerpting portion of, or altering the content of the report is not permitted without the written authorization of AGC. The test results presented in the report apply only to the tested sample. Any objections to report issued by AGC should be submitted to AGC within 15days after the issuance of the test report. Further enquiry of validity or verification of the test report should be addressed to AGC by agc01@agccert.com.

**Test Laboratory: AGC Lab**  
**LTE Band 14 Mid-Edge 3(Bottom) (1 RB#0)**  
**DUT: Body Worn Camera ; Type: K7**

**Date: Dec. 09, 2023**

Communication System: LTE; Communication System Band: LTE Band 14; Duty Cycle:1:1; Conv.F=1.95;  
Frequency: 793 MHz; Medium parameters used:  $f = 750$  MHz;  $\sigma=0.91$  mho/m;  $\epsilon_r = 38.43$ ;  $\rho = 1000$  kg/m<sup>3</sup> ;  
Phantom section: Flat Section  
Ambient temperature (°C): 20.8, Liquid temperature (°C): 20.5

**SATIMO Configuration:**

Probe: SSE2; Calibrated: May 31, 2023; Serial No.: 2023-EPGO-414  
Sensor-Surface: 4mm (Mechanical Surface Detection)  
Phantom: SAM twin phantom  
Measurement SW: OpenSAR V4\_02\_32

**Configuration/ LTE Band 14 Mid-Edge 3(Bottom)/Area Scan:** Measurement grid: dx=8mm, dy=8mm  
**Configuration/ LTE Band 14 Mid-Edge 3(Bottom)/Zoom Scan:** Measurement grid: dx=8mm,dy=8mm, dz=5m;

<b>Area Scan</b>	surf_sam_plan.txt, h= 5.00 mm
<b>Zoom Scan</b>	5x5x7,dx=8mm dy=8mm dz=5mm
<b>Phantom</b>	Validation plane
<b>Device Position</b>	Edge 3(Bottom)
<b>Band</b>	LTE Band 14
<b>Channels</b>	Middle
<b>Signal</b>	OFDM (Crest factor: 1.0)

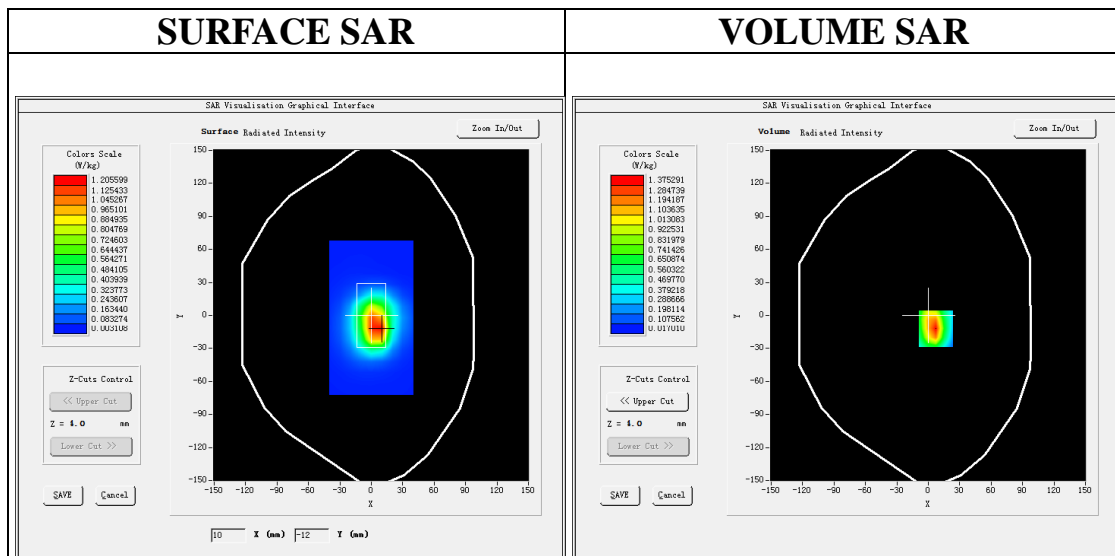

**Maximum location: X=7.00, Y=-12.00**

**SAR Peak: 2.43 W/kg**

<b>SAR 10g (W/Kg)</b>	0.631724
<b>SAR 1g (W/Kg)</b>	1.300253

Any report having not been signed by authorized approver, or having been altered without authorization, or having not been stamped by the “Dedicated Testing/Inspection Stamp” is deemed to be invalid. Copying or excerpting portion of, or altering the content of the report is not permitted without the written authorization of AGC. The test results presented in the report apply only to the tested sample. Any objections to report issued by AGC should be submitted to AGC within 15days after the issuance of the test report. Further enquiry of validity or verification of the test report should be addressed to AGC by agc01@agccert.com.

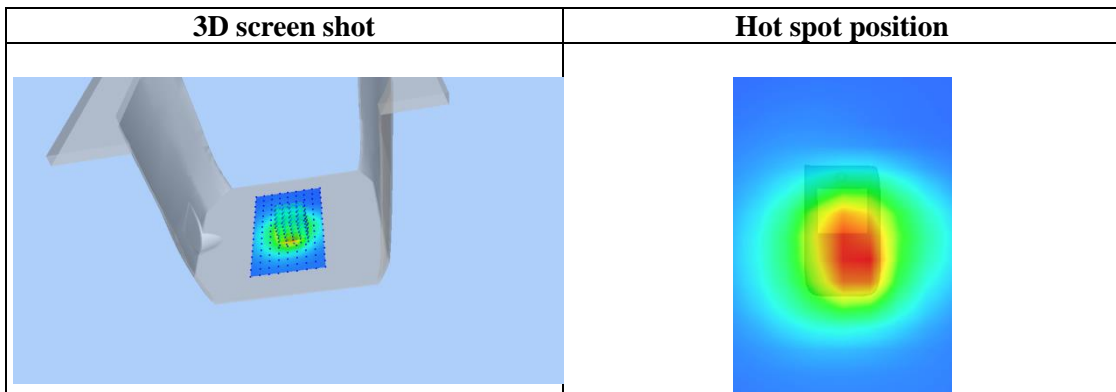
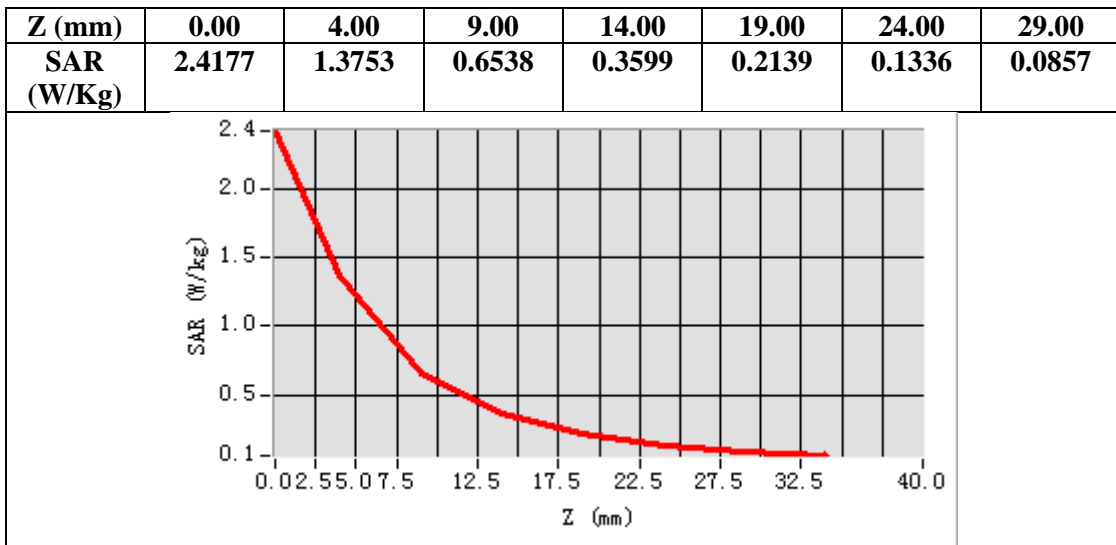

Any report having not been signed by authorized approver, or having been altered without authorization, or having not been stamped by the "Dedicated Testing/Inspection Stamp" is deemed to be invalid. Copying or excerpting portion of, or altering the content of the report is not permitted without the written authorization of AGC. The test results presented in the report apply only to the tested sample. Any objections to report issued by AGC should be submitted to AGC within 15days after the issuance of the test report. Further enquiry of validity or verification of the test report should be addressed to AGC by agc01@agccert.com.

**Test Laboratory: AGC Lab**  
**LTE Band 66 Low-Edge 3(Bottom) (1 RB#0)**  
**DUT: Body Worn Camera ; Type: K7**

**Date: Dec. 20, 2023**

Communication System: LTE; Communication System Band: LTE Band 66; Duty Cycle:1:1; Conv.F=2.17;  
Frequency:1720 MHz; Medium parameters used: f = 1750 MHz;  $\sigma=1.33$  mho/m;  $\epsilon_r=40.32$ ;  $\rho= 1000$  kg/m<sup>3</sup> ;  
Phantom section: Flat Section  
Ambient temperature (°C): 21.7, Liquid temperature (°C): 21.2

**SATIMO Configuration:**

Probe: SSE2; Calibrated: May 31, 2023; Serial No.: 2023-EPGO-414  
Sensor-Surface: 4mm (Mechanical Surface Detection)  
Phantom: SAM twin phantom  
Measurement SW: OpenSAR V4\_02\_32

**Configuration/ LTE Band 66 Low-Edge 3(Bottom)/Area Scan:** Measurement grid: dx=8mm, dy=8mm  
**Configuration/ LTE Band 66 Low-Edge 3(Bottom)/Zoom Scan:** Measurement grid: dx=8mm,dy=8mm, dz=5m;

<b>Area Scan</b>	surf_sam_plan.txt, h= 5.00 mm
<b>Zoom Scan</b>	5x5x7,dx=8mm dy=8mm dz=5mm
<b>Phantom</b>	Validation plane
<b>Device Position</b>	Edge 3(Bottom)
<b>Band</b>	LTE Band 66
<b>Channels</b>	Low
<b>Signal</b>	OFDM (Crest factor: 1.0)

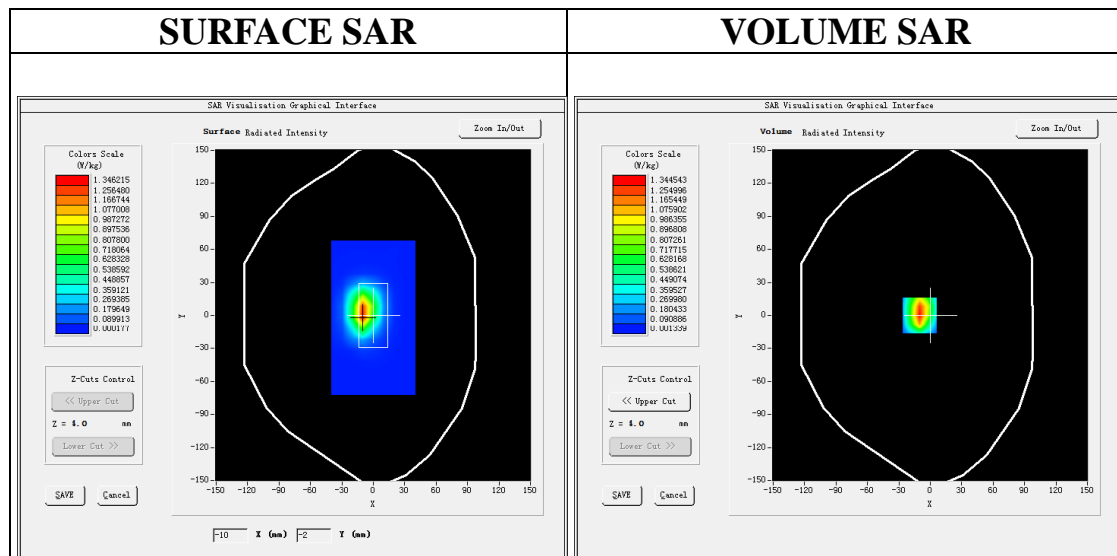

**Maximum location: X=-10.00, Y=0.00**  
**SAR Peak: 2.43 W/kg**

<b>SAR 10g (W/Kg)</b>	0.554986
<b>SAR 1g (W/Kg)</b>	1.248262

Any report having not been signed by authorized approver, or having been altered without authorization, or having not been stamped by the “Dedicated Testing/Inspection Stamp” is deemed to be invalid. Copying or excerpting portion of, or altering the content of the report is not permitted without the written authorization of AGC. The test results presented in the report apply only to the tested sample. Any objections to report issued by AGC should be submitted to AGC within 15days after the issuance of the test report. Further enquiry of validity or verification of the test report should be addressed to AGC by agc01@agccert.com.

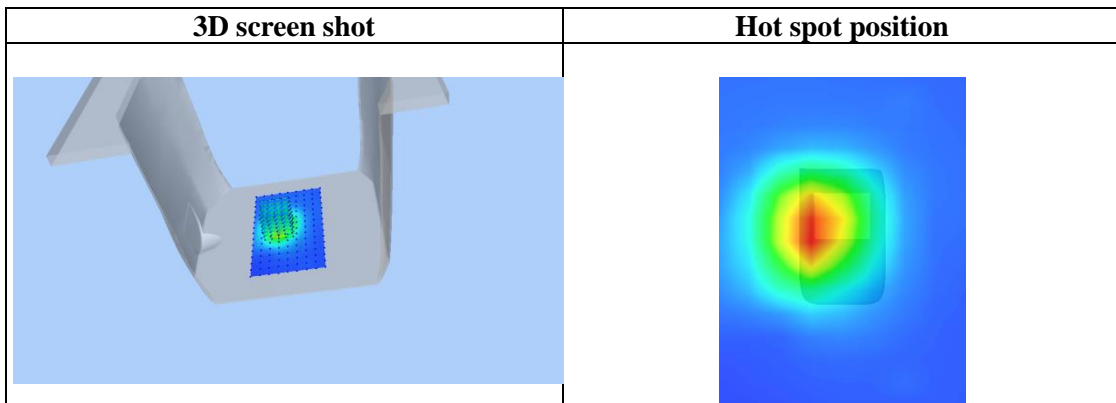
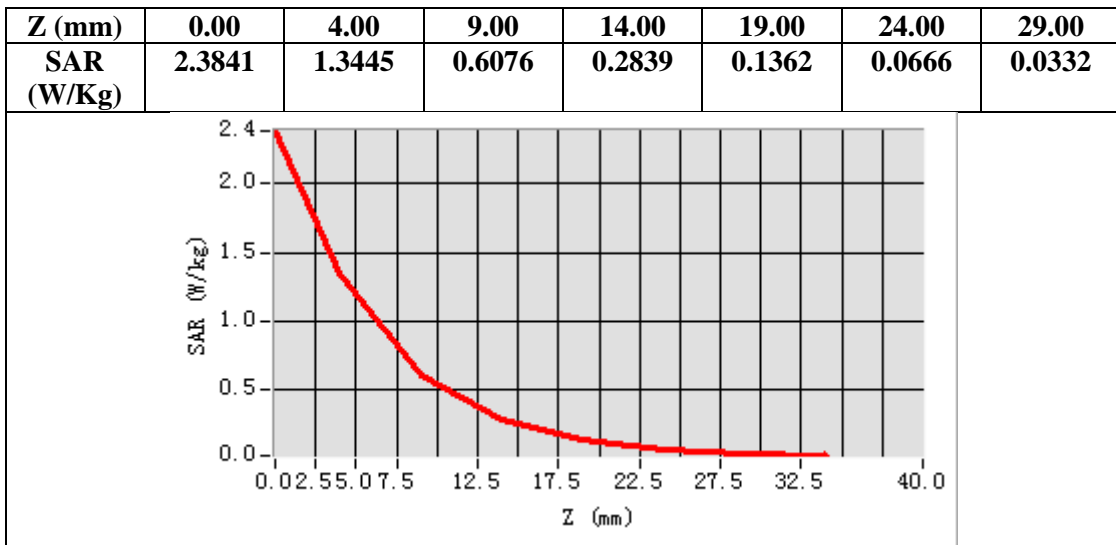

Any report having not been signed by authorized approver, or having been altered without authorization, or having not been stamped by the “Dedicated Testing/Inspection Stamp” is deemed to be invalid. Copying or excerpting portion of, or altering the content of the report is not permitted without the written authorization of AGC. The test results presented in the report apply only to the tested sample. Any objections to report issued by AGC should be submitted to AGC within 15days after the issuance of the test report. Further enquiry of validity or verification of the test report should be addressed to AGC by agc01@agccert.com.

**Test Laboratory: AGC Lab**  
**LTE Band 71 Low-Edge 3(Bottom) (1 RB#0)**  
**DUT: Body Worn Camera ; Type: K7**

**Date: Dec. 09, 2023**

Communication System: LTE; Communication System Band: LTE Band 71; Duty Cycle:1:1; Conv.F=1.95;  
Frequency: 673 MHz; Medium parameters used:  $f = 750$  MHz;  $\sigma=0.81$  mho/m;  $\epsilon_r = 44.34$ ;  $\rho = 1000$  kg/m<sup>3</sup> ;  
Phantom section: Flat Section  
Ambient temperature (°C): 20.8, Liquid temperature (°C): 20.5

**SATIMO Configuration:**

Probe: SSE2; Calibrated: May 31, 2023; Serial No.: 2023-EPGO-414  
Sensor-Surface: 4mm (Mechanical Surface Detection)  
Phantom: SAM twin phantom  
Measurement SW: OpenSAR V4\_02\_32

**Configuration/ LTE Band 71 Low-Edge 3(Bottom)/Area Scan:** Measurement grid: dx=8mm, dy=8mm  
**Configuration/ LTE Band 71 Low-Edge 3(Bottom)/Zoom Scan:** Measurement grid: dx=8mm,dy=8mm, dz=5m;

<b>Area Scan</b>	surf_sam_plan.txt, h= 5.00 mm
<b>Zoom Scan</b>	5x5x7,dx=8mm dy=8mm dz=5mm
<b>Phantom</b>	Validation plane
<b>Device Position</b>	Edge 3(Bottom)
<b>Band</b>	LTE Band 71
<b>Channels</b>	Low
<b>Signal</b>	OFDM (Crest factor: 1.0)

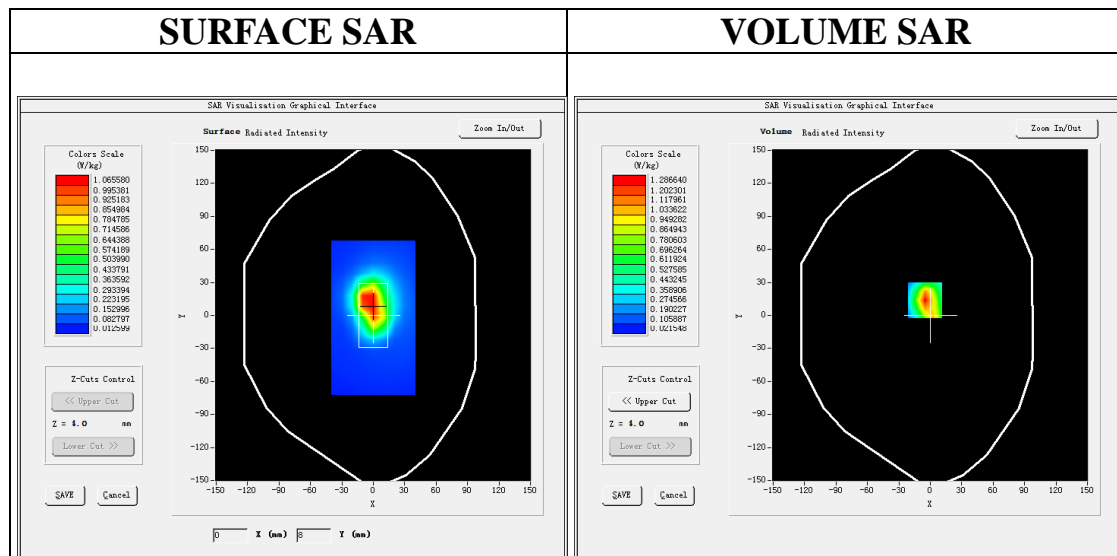

**Maximum location: X=-5.00, Y=14.00**  
**SAR Peak: 2.36 W/kg**

<b>SAR 10g (W/Kg)</b>	0.591227
<b>SAR 1g (W/Kg)</b>	1.257947

Any report having not been signed by authorized approver, or having been altered without authorization, or having not been stamped by the “Dedicated Testing/Inspection Stamp” is deemed to be invalid. Copying or excerpting portion of, or altering the content of the report is not permitted without the written authorization of AGC. The test results presented in the report apply only to the tested sample. Any objections to report issued by AGC should be submitted to AGC within 15days after the issuance of the test report. Further enquiry of validity or verification of the test report should be addressed to AGC by agc01@agccert.com.