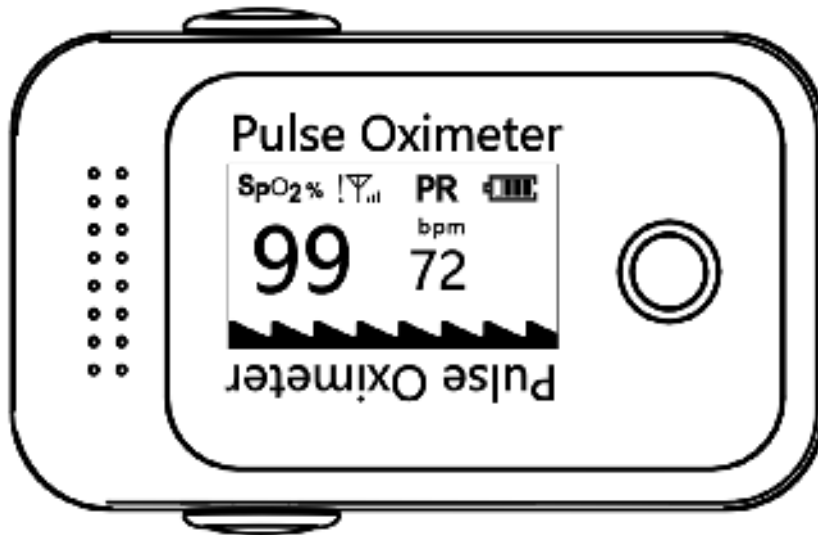


# Operation Manual

## Pulse Oximeter

SMPO1000-US



# *Smart Meter Corporation*

---

Release date: 28/07/2020    Version: 1.0

## **Product Description**

Pulse Oximeter is an important and common device to check oxygen saturation (SpO<sub>2</sub>) and pulse rate. It's a small, compact, simple, reliable and durable physiological monitoring device. It contains the mainboard, OLED display and dry batteries.

## **Intended Use**

The pulse oximeter is a reusable device, and it's intended for intermittent checks of oxygen saturation and pulse rate for adults in a clinical environment. This medical device is not intended for continuous monitoring.

## **Applicable people and scope**

The pulse oximeter is intended for monitoring adults. It is used in clinic settings, outpatient department and sickrooms. It can also be used in the recovery and health care organizations, and the community medical treatments.

## **Contraindications**

The pulse oximeter only applies to adults. And it is not suitable for injured skin tissue.

## **Measurement Principle**

Arterial oxygen saturation is measured via a method which is called oximetry. It is a continuous, non-invasive method based on the different spectra absorption of hemoglobin and oxyhemoglobin (called spectrophotometer principle).

An experience formula of data process is established by taking use of Lambert Beer Law, and according to Spectrum Absorption Characteristics of hemoglobin (Hb) and Oxyhemoglobin (HbO<sub>2</sub>) in glow and near-infrared zones. The operation principle of the instrument is Photoelectric Oxyhemoglobin Inspection Technology. Two beams of different wavelength of lights (666nm visible red light and 905nm near infrared light) can be focused on human nail tip via emitters by adopting the Capacity Pulse Scanning and Recording Technology. Then measured signal will be obtained via a photosensitive element. The amount of light absorbed is related to the amount of oxygen in the blood during these pulses. The ratio of the two absorbed spectrums can be calculated via the microprocessor and the results are compared with the saturation value in the memory, so the blood oxygen saturation value is obtained.

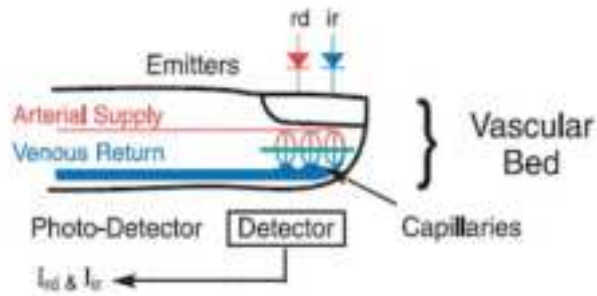


Diagram of Measurement Principle

## Safety Information

- Anyone who uses the pulse oximeter must receive adequate training before use.
- The pulse oximeter is only meant to assess patients' physiological conditions. It must be used in conjunction with clinical symptoms. It is not intended for treatment.
- When using the pulse oximeter in conjunction with the electrical surgery equipment, the user should ensure safety of the patient.
- **EXPLOSION HAZARD:** Do not use the pulse oximeter in the presence of flammable anesthetics, explosive substances, vapors or liquids.
- It is forbidden to use the pulse oximeter in MRI (magnetic resonance imaging) scanning or CT (Computed Tomography) because the induced current could cause potential burning.
- The pulse oximeter does not include an alarm function. Therefore, continuous monitoring for long periods of time is not suitable.
- Modification of the pulse oximeter is not allowed. Any product maintenance should be done by manufacturer-approved, professional maintenance personnel.
- Please shut off the power before cleaning the pulse oximeter. Disinfecting the pulse oximeter via high-pressure and high-temperature methods is prohibited. Any cleaning agents/disinfectants other than recommended ones listed in the operation manual are not allowed for use.
- The pulse oximeter is not waterproof. Keep its surface dry and clean and prevent any liquid from infiltrating the product.
- The pulse oximeter is fragile and requires precision to function properly. Avoid any pressure, jostling, strong vibrations, or other potential mechanical damage. Hold it carefully and lightly. If it is not in use, the pulse oximeter should be appropriately stored.
- Do not dispose the pulse oximeter randomly. Disposal procedure should follow local regulations or hospital policy regarding disposal of the pulse oximeter and accessories.
- Use AAA alkaline batteries. Do not use carbon or poor quality batteries. Remove the batteries if the pulse oximeter hasn't been used for a long time.
- A functional tester can't be used to assess the accuracy.
- If the patient is the intended operator, the patient must read the operation manual carefully or consult with a doctor and/or manufacturer before usage. If there's any discomfort while using the pulse oximeter, stop usage immediately and go to the hospital.
- To avoid any static electricity damage to the pulse oximeter, direct or indirect static

electricity should be discharged before usage.

- Try to keep the pulse oximeter away from any radio receivers when it's in use.
- If the pulse oximeter uses with configuration which does not pass EMC test, it can enhance electromagnetic radiation or reduce anti-electromagnetic interference performance. Please use the specified configuration.
- The pulse oximeter should not be in close proximity (or stacked) with other devices. If that's not possible, it should be observed and verified that the oximeter can run normally with the close proximity/stacked configuration.
- There should be no dirt or wound on the tested surface (i.e finger).
- Federal law restricts this device to sale by the order of a physician.

## Product Feature

1. Simple and convenient operation with one button.
2. Compact, lightweight, and convenient to carry.
3. Long battery life for more than 500 times measurement and upload on normal condition.
4. Battery and network indicator on screen.
5. Automatically upload test record to server after each measurement.
6. Automatically shut down after 10 seconds without finger inserted or after upload is done.

## Product structure

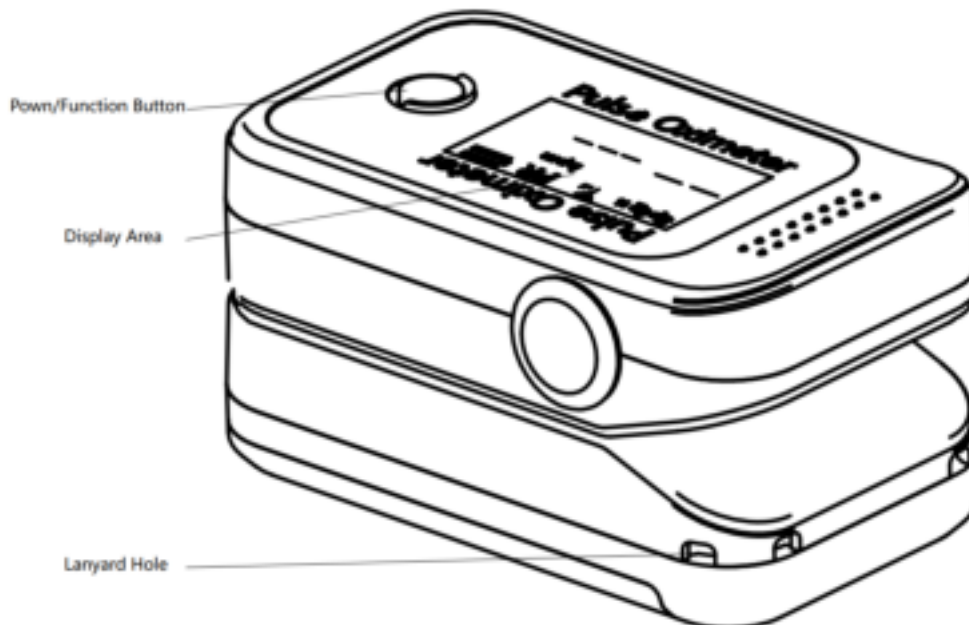
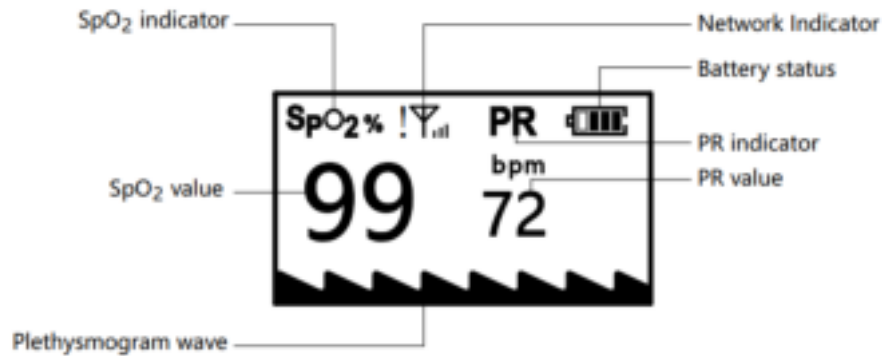


Figure 1

## Display Introduction



## Battery Installation

1. Hold the product in one hand with the front panel facing the palm. Put the other hand's big finger on lid's press sign of the battery compartment, press downwards and push the lid and open it at the same time. The battery compartment is opened as shown in **Figure 2**.
2. Install batteries into the slots according to the "+" and "-" symbols as shown in **Figure 3**.  
Cover the lid onto the battery compartment and push it upwards to make it close.
  - The positive and negative ends of batteries must be installed correctly, otherwise the device may be damaged.
  - When installing or removing batteries, please follow the correct operation procedure, otherwise the battery compartment may be damaged.



Figure 2

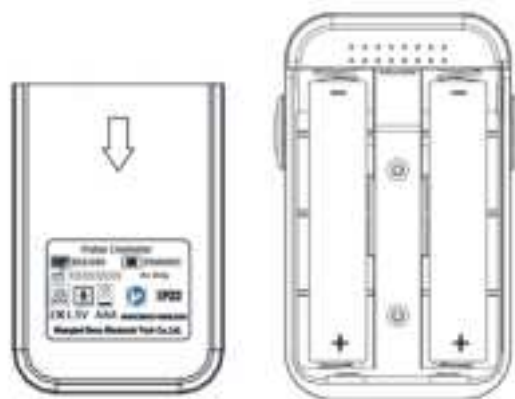
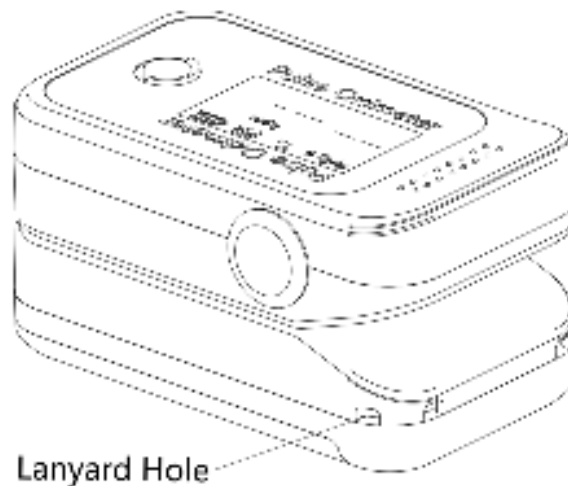


Figure 3

## Lanyard Installation

1. Thread the thinner end of the lanyard through the lanyard hole. The position of the lanyard hole is shown in **Figure 4**. (Notice: the lanyard hole is on both sides.)
2. Thread the thicker end of the lanyard through the thinner end of the lanyard. Then, pull the thicker end of the lanyard until it's tight.



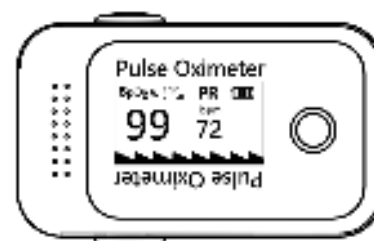
**Figure 4**

### Directions for use

1. After properly installing two AAA batteries, press lid's press sign as shown in the **Figure 5** and open the clip. Let the testee's finger put into the rubber cushions of the clip, make sure the finger is in the right position as shown in **Figure 5**, and then loosen the clip.
  2. Just wait for a moment, the SpO<sub>2</sub> value and PR value will be displayed on the OLED screen after plethysmograph wave and measured values are stable, as shown in **Figure 6**.
- **Be sure to place the patient's finger inside the product in the correct orientation. The LED part of the sensor should be at the backside of the patient hand. Be sure to insert the finger deep enough into the sensor so that the fingernail is opposite to the light emitted from the sensor.**
  - **Don't move the finger and remain motionless during the process.**
  - **Data update period is less than 30 seconds.**



**Figure 5**



**Figure 6**

### NOTE:

- **Check the pulse oximeter for damage before use. If it's damaged, don't use it.**

- Don't put the pulse oximeter on extremities with arterial catheter or venous syringe.
- Don't perform SpO<sub>2</sub> and NIBP measurements on the same arm simultaneously. Obstruction of blood flow during NIBP measurements may adversely affect the reading of the SpO<sub>2</sub> value.
- Don't use the pulse oximeter to measure patients whose pulse rates are lower than 30bpm (this may cause incorrect results).
- The well perfusion of measuring instrument should fully cover the test window of the sensor. Clean and dry the measurement part before storing the pulse oximeter.
- Cover the sensor with opaque material under strong light. Otherwise, the light can cause inaccurate measurements.
- Make sure that there is no contamination or scarring on the tested finger. Otherwise, the results may be incorrect.
- The product is prone to cross-contamination when used on different patients. Disinfection is recommended before using the product on other patients.
- Incorrect placement of the sensor may affect the accuracy of the measurements. The same horizontal position with heart should be chosen to achieve the best measurements.
- The highest temperature of usage shouldn't exceed 41°C.
- Change sensor location and check skin integrity and circulatory status at least every 2 hours.

Factors affecting measurement accuracy:

- The measurements depend on absorption of special wavelength ray by oxidized hemoglobin and deoxyhemoglobin. The concentration of non-functional hemoglobin may affect the accuracy of the measurement.
- Shock, anemia, hypothermia, and vasoconstrictive drugs may decrease arterial blood flow to an unmeasurable level.
- Pigments or deep colors (i.e nail polish, artificial nails, dyes, or pigmented cream) may cause inaccurate measurements.

## Function Description

a. Press the "POWER/FUNCTION" button to power on the device, press it again to rotate the display orientation, as shown in **Figure 7** and **Figure 8**.

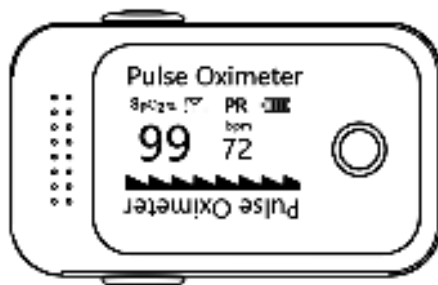


Figure 7

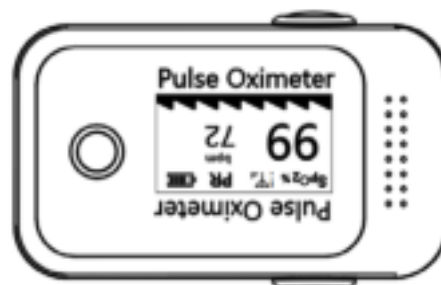
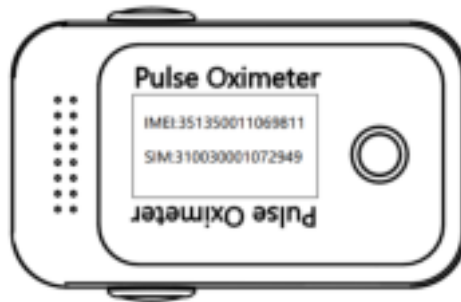


Figure 8

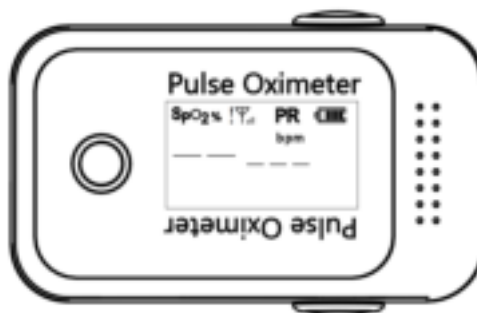
b. Press and hold the "POWER/FUNCTION" button for more than 3 seconds to show the IMEI

and SIM card number, press it again to exit, as shown in **Figure 9**.



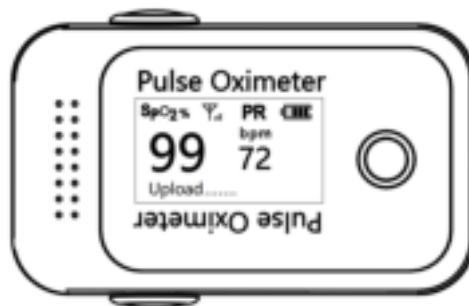
**Figure 9**

c. When there is no finger inserted, the invalid value "--- ---" will be displayed on the screen, as shown in **Figure 10**.

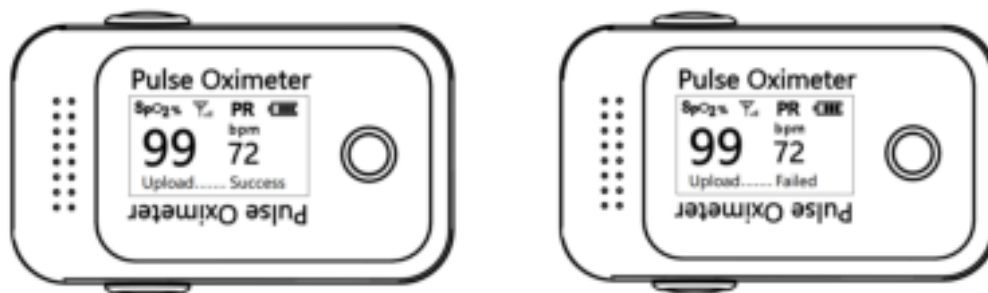


**Figure 10**

d. When the measurement is finished and the network is available, the upload procedure will be started automatically, as shown in **Figure11**, and it will end with success or failed, as shown in **Figure12** and **Figure13**. If the upload is failed, the current measurement record will be saved automatically and re-uploaded at next time.



**Figure 11**



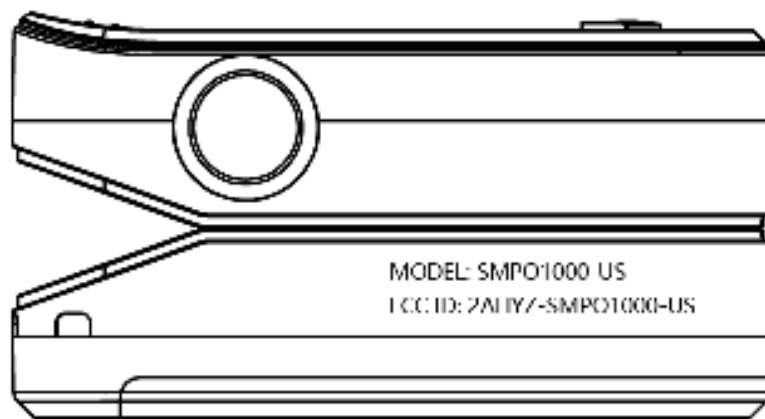


**Figure 12**

**Figure 13**

e. The product will automatically shut down when there is no finger inserted for more than 10 seconds or after upload is finished.

**FCC ID label**



**FCC statements:**

This device complies with part 15 of the FCC Rules. Operation is subject to the following two conditions:

- (1) This device may not cause harmful interference, and
- (2) this device must accept any interference received, including interference that may cause undesired operation.








Changes or modifications not expressly approved by the party responsible for compliance could void the user's authority to operate the equipment.

**NOTE:** This equipment has been tested and found to comply with the limits for a Class B digital device, pursuant to part 15 of the FCC Rules.

These limits are designed to provide reasonable protection against harmful interference in a residential installation. This equipment generates, uses and can radiate radio frequency energy and, if not installed and used in accordance with the instructions, may cause harmful interference to radio communications. However, there is no guarantee that interference will not occur in a particular installation. If this equipment does cause harmful interference to radio or television reception, which can be determined by turning the equipment off and on, the user is encouraged to try to correct the interference by one or more of the following measures:

- Reorient or relocate the receiving antenna.
- Increase the separation between the equipment and receiver.
- Connect the equipment into an outlet on a circuit different from that to which the receiver is connected.
- Consult the dealer or an experienced radio/ TV technician for help.

## Network Indicator Description

Symbol	Description
	SIM card is not inserted
	No signal
	Signal is weak
	Signal is normal
	Signal is good
	Signal is perfect
	Network is unattached

## Cleaning and Disinfection

- Do not immerse the oximeters and any relevant accessories in water or disinfectant.
- We recommend that the product be disinfected only when necessary to avoid long-term damage to the product.
- Don't use cleaning agents/disinfectants other than the recommended models.
- Don't disinfect the device via high-pressure and high-temperature.
- Shut off the power and take out the batteries before cleaning and disinfecting.

### Cleaning

1. Clean the product with cotton or soft cloth moistened with water.
2. After cleaning, wipe off the water with a soft cloth.
3. Leave the device to dry naturally.

### Disinfection

The recommended disinfectants include: ethanol 70%, isopropanol 70%, glutaraldehyde (2%) solution disinfectants.

1. Clean the product as instructed above.
2. Disinfect the product with cotton or soft cloth moistened with one of the recommended disinfectants.
3. After disinfection, be sure to wipe off the disinfectant left on the product with a soft cloth moistened with water.
4. Leave the device to dry naturally.

## Packing List

<b>The standard configuration</b>	
Pulse Oximeter	1pc
Lanyard	1pc
The operation manual	1pc

**Expected service life:** 3 years

## Technical Specifications

1. **Display mode:** OLED
  2. **SpO<sub>2</sub>:**  
 Measurement range: 35~100%  
 Accuracy: ±3% (70%~100%)
  3. **Pulse Rate:**  
 Measurement range: 25~250bpm  
 Accuracy: ±2bpm
    - **Pulse Rate accuracy has passed the verification and comparison with SpO<sub>2</sub> simulator.**
  4. **Low perfusion:**  
 Range: 0.5%~20%  
 SpO<sub>2</sub> accuracy: ±3% (70%~100%)  
 PR accuracy: 25~250bpm ±2bpm
  5. **Electrical specifications:**  
 Working voltage: D.C.2.2 V~D.C.3.4V  
 Battery Type: Two 1.5V AAA alkaline batteries  
 Battery Life: More than 500 times measurement and upload on normal condition.
  6. **Product specifications:**  
 Size: 58 (H) × 34 (W) × 30(D) mm  
 Weight: 50g (include two AAA batteries)
  7. **Environment requirements:**
    - Temperature:**  
 Operation: +5~+40°C  
 Transport and storage: -10~+50°C
    - Humidity:**  
 Operation: 15%~80% (noncondensing)  
 Transport and storage: 10%~90% (noncondensing)
    - Atmospheric pressure:**  
 Operation: 860hPa~1060hPa  
 Transport and storage: 700hPa~1060hPa
- NOTE:**
- **A functional tester can't be used to assess this product's accuracy.**
  - **The purpose of confirming the blood oxygen measurement's accuracy is to compare the oximetry measurement value with the value of blood gas analyzer.**
8. **LED:**

Wavelength: 666nm/905nm

Output power: <0.1mW

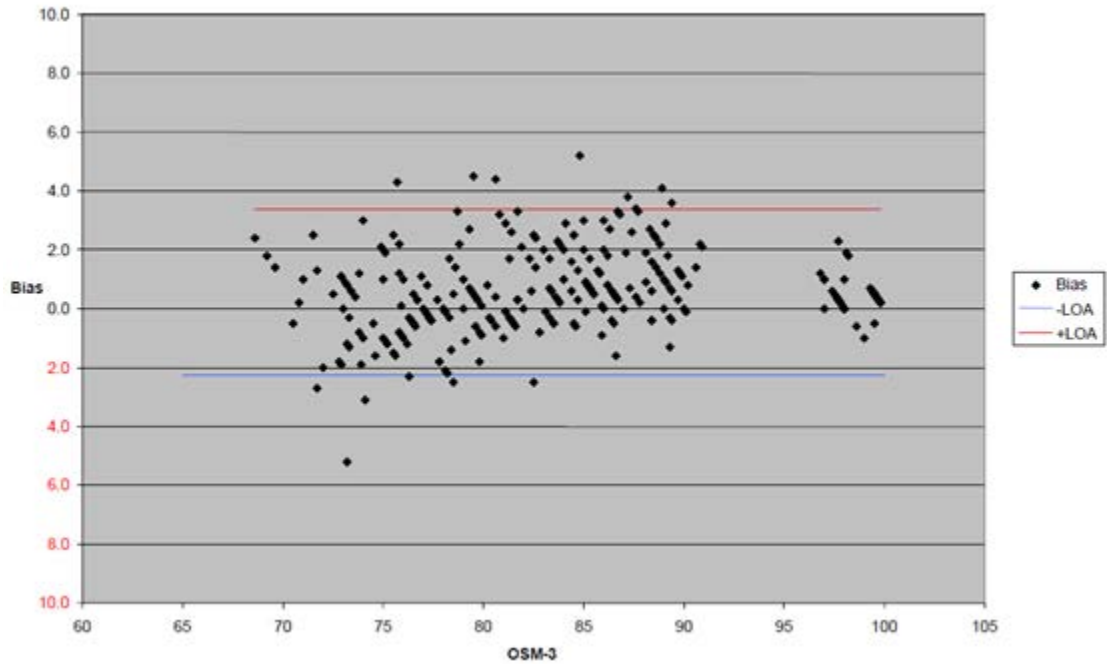
## Arms Specifications

### 1. SpO<sub>2</sub> Arms:

SpO <sub>2</sub> Range	Arms Specification
70% - 80%	1.65
80% - 90%	1.22
90% - 100%	1.11

### 2. Clinical Data Graphical Plot:










Hemoximeter Range	60-80	80-100	60-100	70-100	60-70	70-80	80-90	90-100
Mean	0.27	0.74	0.58	0.57	0.90	0.25	1.00	0.12
Count	102	185	287	284	3	99	131	54
Missing Data	0	2	2	2	0	0	0	2
Standard Deviation	1.64	1.25	1.42	1.42	1.23	1.65	1.22	1.11
Standard Error	0.16	0.09	0.08	0.08	0.71	0.17	0.11	0.15
95% Confidence Interval	0.32	0.18	0.16	0.17	1.39	0.33	0.21	0.30
Upper LOA	3.55	3.22	3.38	3.38	N/A	3.55	3.42	2.29
Lower LOA	-3.01	-1.73	-2.23	-2.24	N/A	-3.05	-1.42	-2.05
Maximum	4.50	5.20	5.20	5.20	1.80	4.50	5.20	2.40
Minimum	-5.20	-3.10	-5.20	-5.20	-0.50	-5.20	-1.60	-3.10
Root Mean Square	1.66	1.45	1.53	1.53	1.35	1.67	1.57	1.11



## Troubleshooting

Trouble	Possible reason	solution
The SpO <sub>2</sub> and PR can't be displayed normally and the value disappeared.	<ol style="list-style-type: none"> <li>The finger is not properly positioned.</li> <li>The patient's SpO<sub>2</sub> is too low to be detected.</li> </ol>	<ol style="list-style-type: none"> <li>Please try again.</li> <li>Try again; Go to a hospital for a diagnosis if you are sure the device works all right.</li> </ol>
The SpO <sub>2</sub> and PR display unstable.	<ol style="list-style-type: none"> <li>The finger is not placed inside enough.</li> <li>The finger is shaking or the testee is moving.</li> </ol>	<ol style="list-style-type: none"> <li>Place the finger properly and try again.</li> <li>Let the testee keep calm.</li> </ol>
The device can't be powered on.	<ol style="list-style-type: none"> <li>The batteries are drained or almost drained.</li> <li>The installation of batteries is not correct.</li> <li>The device's malfunction.</li> </ol>	<ol style="list-style-type: none"> <li>Change batteries.</li> <li>Reinstall batteries.</li> <li>Please contact the supplier.</li> </ol>
The screen is suddenly off.	<ol style="list-style-type: none"> <li>The product will automatically shut down when there is no finger inserted for more than 10 seconds or after upload is finished.</li> <li>Power of the batteries is exhausted.</li> </ol>	<ol style="list-style-type: none"> <li>Normal.</li> <li>Replace the batteries.</li> </ol>

## Symbol Meaning

Symbol	Meaning
	“CAUTIOUS”! Please refer to the operation manual.
	Type <b>BF</b> Equipment.
	The product does not contain alarm function.
	When the end-user wishes to discard this product, it must be sent to separate collection facilities for recovery and recycling.
	Information of manufacture, including name and address.
	Date of manufacture.
	Serial Number.
	Batch Code.
	Type Number.
<b>IP22</b>	Degrees of protection provided by enclosure.

## Appendix A EMC Declaration

### Guidance and manufacturer's declaration - electromagnetic emissions - for all EQUIPMENT and SYSTEMS

<b>Guidance and manufacturer's declaration - electromagnetic emission</b>		
The Pulse Oximeter is intended for use in the electromagnetic environment specified below. The customer or the user of the Pulse Oximeter should assure that it is used in such an environment.		
<b>Emission test</b>	<b>Compliance</b>	<b>Electromagnetic environment-guidance</b>
RF emissions CISPR 11	Group 1	The Pulse Oximeter uses RF energy only for its internal function. Therefore, its RF emissions are very low and are not likely to cause any interference in nearby electronic equipment.
RF emissions CISPR11	Class B	The Pulse Oximeter is suitable for use in all establishments, including domestic establishments and those directly connected to a low voltage power supply network which supplies buildings used for domestic purposes.

### Guidance and manufacturer's declaration - electromagnetic immunity - for all EQUIPMENT and SYSTEMS

<b>Guidance and manufacturer's declaration-electromagnetic immunity</b>			
The Pulse Oximeter is intended for use in the electromagnetic environment specified below. The customer or the user of the Pulse Oximeter should assure that it is used in such an environment.			
<b>Immunity test</b>	<b>IEC 60601 test level</b>	<b>Compliance level</b>	<b>Electromagnetic environment - guidance</b>
ELECTROSTATIC DISCHARGE <sup>a)</sup> IEC 61000-4-2	±8 KV contact ±2 KV, ±4 KV, ±8 KV, ±15 KV air	±8 KV contact ±2 KV, ±4 KV, ±8 KV, ±15 KV air	Floors should be wood, concrete or ceramic tile. If floor are covered with synthetic material, the relative humidity should be at least 30%.
RATED power frequency magnetic fields <sup>b) c)</sup> IEC 61000-4-8	30A/m <sup>d)</sup> 50 Hz or 60 Hz	30A/m <sup>d)</sup>	Mains power quality should be that of a typical commercial or hospital environment.

- a) Discharges shall be applied with no connection to an artificial hand and no connection to PATIENT simulation. PATIENT simulation may be connected after the test as needed in order to verify BASIC SAFETY and ESSENTIAL PERFORMANCE.
- b) Applies only to ME EQUIPMENT and ME SYSTEMS with magnetically sensitive components or circuitry.
- c) During the test, the ME EQUIPMENT or ME SYSTEMS may be powered at any NOMINAL input voltage, but with the same frequency as the test signal (see Table 1).
- d) This test level assumes a minimum distance between the ME EQUIPMENT or ME SYSTEMS and sources of power frequency magnetic field of at least 15 cm. If the RISK ANALYSIS shows that the ME EQUIPMENT or ME SYSTEMS will be used closer than 15 cm to sources of power frequency magnetic field, the IMMUNITY TEST LEVEL shall be adjusted as appropriate for the minimum expected distance.

**Guidance and manufacturer's declaration - electromagnetic immunity -  
for all EQUIPMENT and SYSTEMS that are not LIFE - SUPPORTING**

<b>Guidance and manufacturer's declaration - electromagnetic immunity</b>		
The Pulse Oximeter is intended for use in the electromagnetic environment specified below. The customer or the user of the Pulse Oximeter should assure that it is used in such an environment.		
<b>Immunity test</b>	<b>IEC 60601 test level</b>	<b>Compliance level</b>
Conducted disturbances included by RF fields <sup>a)</sup> IEC 61000-4-6	3 V <sup>b)</sup> 0.15 MHz - 80 MHz 6 V <sup>b)</sup> in ISM and amateur radio bands between 0.15 MHz and 80 MHz 80% AM at 1 kHz	3 V <sup>b)</sup>  6 V <sup>b)</sup>
Radiated RF EM fields <sup>c)</sup> IEC 61000-4-3	10 V/m <sup>b)</sup> 80 MHz – 2.7 GHz <sup>d)</sup> 80% AM at 1 kHz <sup>e)</sup>	10 V/m <sup>b)</sup>
<p><sup>a)</sup> The following apply:</p> <ul style="list-style-type: none"> <li>- All PATIENT-COUPLED cables shall be tested, either individually or bundled</li> <li>- PATIENT-COUPLED cables shall be tested, using a current clamp unless a current clamp is not suitable. In cases where a current clamp is not suitable, an EM clamp shall be used.</li> <li>- No intentional decoupling device shall be used between the injection point and the PATIENT COUPLING POINT in any case.</li> <li>- Testing may be performed at other modulation frequencies identified by the RISK MANAGEMENT PROCESS.</li> <li>- Tubes that are intentionally filled with conductive liquids and intended to be connected to a PATIENT shall be considered to be PATIENT-COUPLED cables.</li> <li>- If the frequency stepping skips over an ISM or amateur radio band, as applicable, an</li> </ul>		



additional test frequency shall be used in the ISM or amateur radio band. This applies to each ISM and amateur radio band within the specified frequency range.

- The ISM (industrial, scientific and medical) bands between 0.15 MHz and 80 MHz are 6.765 MHz to 6.795 MHz; 13.553 MHz to 13.567 MHz; 26.957 MHz to 27.283 MHz; and 40.66 MHz to 40.70 MHz. The amateur radio bands between 0.15 MHz and 80 MHz are 1.8 MHz to 2.0 MHz, 3.5 MHz to 4.0 MHz, 5.3 MHz to 5.4 MHz, 7 MHz to 7.3 MHz, 10.1 MHz to 10.15 MHz, 14 MHz to 14.2 MHz, 18.07 MHz to 18.17 MHz, 21.0 MHz to 21.4 MHz, 24.89 MHz to 24.99 MHz, 28.0 MHz to 29.7 MHz and 50.0 MHz to 54.0 MHz.

b) Before modulation is applied

c) The interface between the PATIENT physiological simulation, if used, and the ME EQUIPMENT or ME EQUIPMENT shall be located within 0, 1 m of the vertical plane of the uniform field area in one orientation of the ME EQUIPMENT of ME SYSTEM.

d) ME EQUIPMENT and ME SYSTEM that intentionally receive RF electromagnetic energy for the purpose of their operation shall be tested at the frequency of reception. Testing may be performed at other modulation frequencies identified by the RISK MANAGEMENT PROCESS. This test assesses the BASIC SAFETY and ESSENTIAL PERFORMANCE of an intentional receiver when an ambient signal is in the passband. It is understood that the receiver might not achieve normal reception during the test.

e) Testing may be performed at other modulation frequencies identified by the RISK MANAGEMENT PROCESS.